

# Vostro 16 5640

## Owner's Manual

## Notes, cautions, and warnings

 **NOTE:** A NOTE indicates important information that helps you make better use of your product.

 **CAUTION:** A CAUTION indicates either potential damage to hardware or loss of data and tells you how to avoid the problem.

 **WARNING:** A WARNING indicates a potential for property damage, personal injury, or death.

<b>Chapter 1: Views of Vostro 16 5640</b>	<b>7</b>
Right	7
Left	7
Top	8
Front	9
Bottom	10
Service Tag	11
Battery charge and status light	11
<b>Chapter 2: Set up your Vostro 16 5640</b>	<b>12</b>
<b>Chapter 3: Specifications of Vostro 16 5640</b>	<b>15</b>
Dimensions and weight	15
Processor	15
Chipset	16
Operating system	16
Memory	17
External ports	17
Internal slots	18
Ethernet	18
Wireless module	18
Audio	19
Storage	19
Media-card reader	19
Keyboard	20
Keyboard function keys	20
Camera	22
Touchpad	22
Power adapter	22
Battery	23
Display	24
Fingerprint reader (optional)	25
Sensor	25
GPU—Integrated	25
Multiple display support matrix	26
Hardware security	26
Operating and storage environment	26
ComfortView	26
ComfortView Plus	27
<b>Chapter 4: Working inside your computer</b>	<b>28</b>
Safety instructions	28
Before working inside your computer	28
Safety precautions	29

Electrostatic discharge—ESD protection.....	29
ESD Field Service kit .....	30
Transporting sensitive components.....	31
After working inside your computer.....	31
BitLocker.....	31
Recommended tools.....	31
Screw list.....	32
Major components of Vostro 16 5640.....	33
<b>Chapter 5: Removing and installing Customer Replaceable Units (CRUs).....</b>	<b>36</b>
Base cover.....	36
Removing the base cover.....	36
Installing the base cover .....	38
Memory module.....	41
Removing the memory module .....	41
Installing the memory module .....	42
M.2 solid state drive.....	43
Removing the solid-state drive .....	43
Installing the solid-state drive .....	44
Wireless card.....	45
Removing the wireless card .....	45
Installing the wireless card .....	46
Speakers.....	47
Removing the speakers .....	47
Installing the speakers .....	49
Fan.....	51
Removing the fan .....	51
Installing the fan .....	52
<b>Chapter 6: Removing and installing Field Replaceable Units (FRUs).....</b>	<b>54</b>
Battery.....	54
Rechargeable Li-ion battery precautions.....	54
Removing the battery .....	54
Disconnecting the battery cable .....	55
Connecting the battery cable .....	57
Installing the battery .....	58
Heat sink.....	60
Removing the heat sink .....	60
Installing the heat sink .....	61
Touchpad.....	62
Removing the touchpad assembly .....	62
Installing the touchpad assembly .....	63
Display assembly.....	65
Removing the display assembly .....	65
Installing the display assembly .....	66
I/O-board cable .....	68
Removing the I/O-board cable.....	68
Installing the I/O-board cable.....	69
I/O board.....	70

Removing the I/O board .....	70
Installing the I/O board .....	71
Power button.....	73
Removing the power button .....	73
Installing the power button .....	74
Power button with optional fingerprint reader.....	75
Removing the power button with optional fingerprint reader .....	75
Installing the power button with optional fingerprint reader .....	76
Power-adapter port.....	77
Removing the power-adapter port .....	77
Installing the power-adapter port .....	78
System board.....	79
Removing the system board .....	79
Installing the system board .....	83
Palm-rest and keyboard assembly.....	86
Removing the palm-rest and keyboard assembly .....	86
Installing the palm-rest and keyboard assembly .....	88
<b>Chapter 7: Software.....</b>	<b>90</b>
Operating system.....	90
Drivers and downloads.....	90
<b>Chapter 8: BIOS Setup.....</b>	<b>91</b>
Entering BIOS setup program.....	91
Navigation keys.....	91
F12 One Time Boot menu.....	91
System setup options.....	92
Updating the BIOS.....	98
Updating the BIOS in Windows.....	98
Updating the BIOS in Linux and Ubuntu.....	99
Updating the BIOS using the USB drive in Windows.....	99
Updating the BIOS from the F12 One-Time boot menu.....	99
System and setup password.....	100
Assigning a System or Admin password.....	100
Deleting or changing an existing System or Admin password.....	101
Clearing BIOS (System Setup) and System passwords.....	101
<b>Chapter 9: Troubleshooting.....</b>	<b>102</b>
Handling swollen rechargeable Li-ion batteries.....	102
Locate the Service Tag or Express Service Code of your Dell computer .....	102
Dell SupportAssist Pre-boot System Performance Check diagnostics.....	103
Running the SupportAssist Pre-Boot System Performance Check.....	103
Built-in self-test (BIST).....	103
M-BIST.....	103
LCD Power rail test (L-BIST).....	104
LCD Built-in Self-Test (BIST).....	104
System-diagnostic lights.....	105
Recovering the operating system.....	105
Real-Time Clock (RTC Reset).....	106

Backup media and recovery options..... 106  
Wi-Fi power cycle..... 106  
Drain residual flea power (perform hard reset).....106

**Chapter 10: Getting help and contacting Dell..... 108**

# Views of Vostro 16 5640

## Right

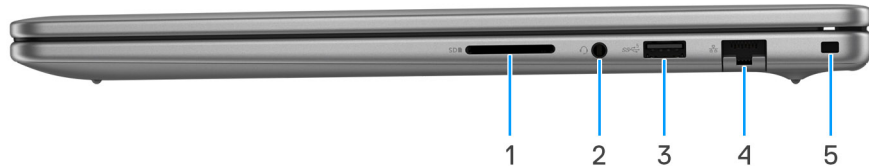

Figure 1. Right view

### 1. SD-card slot

Reads from and writes to the SD card. The computer supports the following card types:

- Secure Digital (SD)
- Secure Digital High Capacity (SDHC)
- Secure Digital Extended Capacity (SDXC)

### 2. Universal audio port

Connect headphones or a headset (headphone and microphone combo).

### 3. USB 3.2 Gen 1 (5 Gbps) port

Connect devices such as external storage devices and printers. Provides data transfer speeds of up to 5 Gbps.

### 4. Network port

Connect an Ethernet (RJ45) cable from a router or a broadband modem for network or Internet access, with a transfer rate of 10/100/1000 Mbps.

### 5. Wedge-shaped lock slot

Connect a security cable to prevent unauthorized movement of your computer.

## Left



Figure 2. Left view

### 1. Power-adaptor port (primary power)

Connect a power adapter to provide power to your computer and charge the battery.

### 2. Power and battery-status light

Indicates the power state and battery state of the computer.

Solid white—Power adapter is connected and the battery is charging.

Solid amber—Battery charge is low or critical.

Off—Battery is fully charged.

**NOTE:** On certain computers, the power and battery-status light is also used for diagnostics. For more information, see the *Troubleshooting* section in the *Owner's Manual* of your computer.

### 3. HDMI 1.4 port

Connect to a TV, external display, or another HDMI-in enabled device. Provides video and audio output.

### 4. USB 3.2 Gen 1 (5 Gbps) port

Connect devices such as external storage devices and printers. Provides data transfer speeds of up to 5 Gbps.

### 5. USB 3.2 Gen 2 (10 Gbps) Type-C with DisplayPort AltMode 1.4 and Power Delivery port

Connect devices such as external storage devices, printers, and external displays. Provides data transfer rate of up to 10 Gbps.

Supports Power Delivery that enables two-way power supply between devices. Provides up to 15 W power output that enables faster charging.

**NOTE:** A USB Type-C to DisplayPort adapter (sold separately) is required to connect a DisplayPort device.

## Top

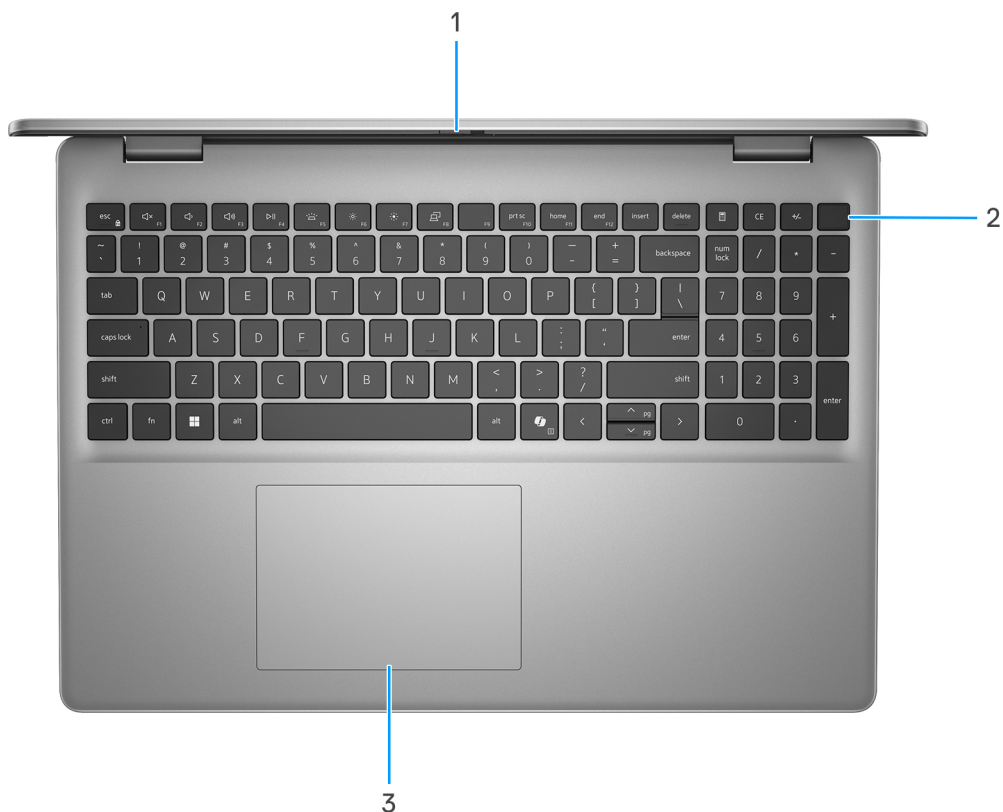

**Figure 3. Top view**

#### 1. Privacy shutter

Slide the privacy shutter to cover the camera lens and protect your privacy when the camera is not in use.

#### 2. Power button with optional fingerprint reader



Press to turn on the computer if it is turned off, in sleep state, or in Hibernate state.

When the computer is turned on, press the power button to put the computer into sleep state; press and hold the power button for ten seconds to force shut-down the computer.

If the power button has a fingerprint reader, place your finger on the power button to log in.

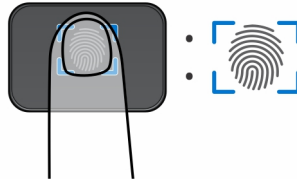

**Figure 4. Active fingerprint reader area**

**NOTE:** The highlighted area indicates the actual active fingerprint reader area, and the image is for illustration purposes only.

**NOTE:** You can customize power-button behavior in Windows. For more information, see [www.dell.com/support/manuals](http://www.dell.com/support/manuals).

### 3. Touchpad

Move your finger on the touchpad to move the mouse pointer. Tap to left-click and two fingers tap to right-click.

## Front

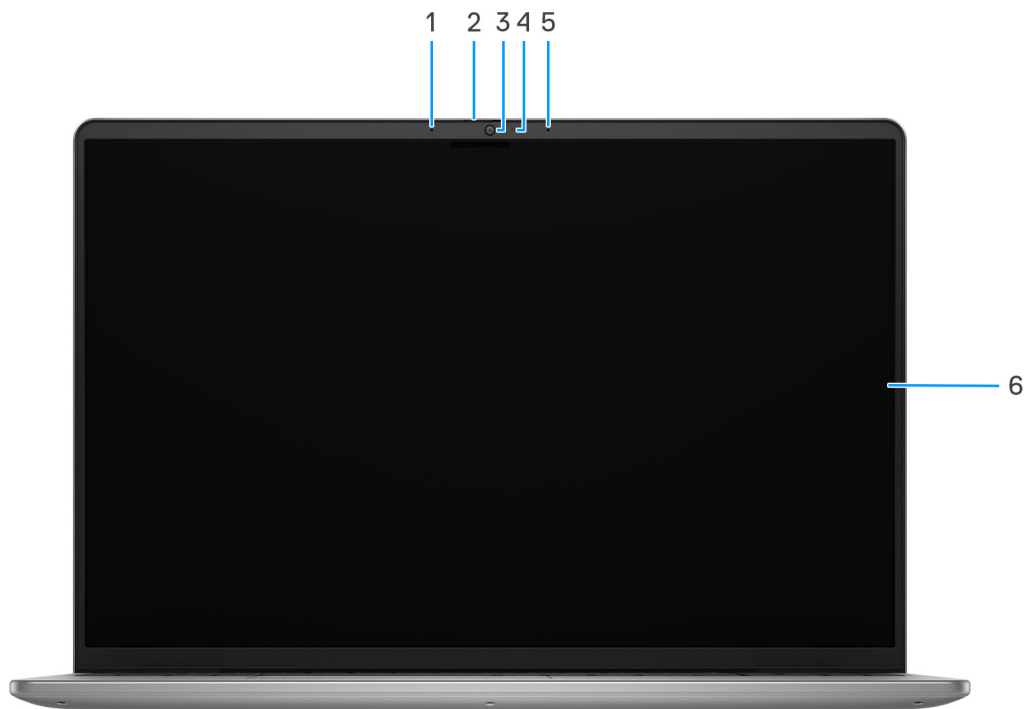

**Figure 5. Front view**

#### 1. Left microphone

Provides digital sound input for audio recording and voice calls.

## 2. Privacy shutter

Slide the privacy shutter to cover the camera lens and protect your privacy when the camera is not in use.

## 3. Camera

Enables you to video chat, capture photos, and record videos.

## 4. Camera-status light

Turns on when the camera is in use.

## 5. Right microphone

Provides digital sound input for audio recording and voice calls.

## 6. Display

Provides visual output.

# Bottom

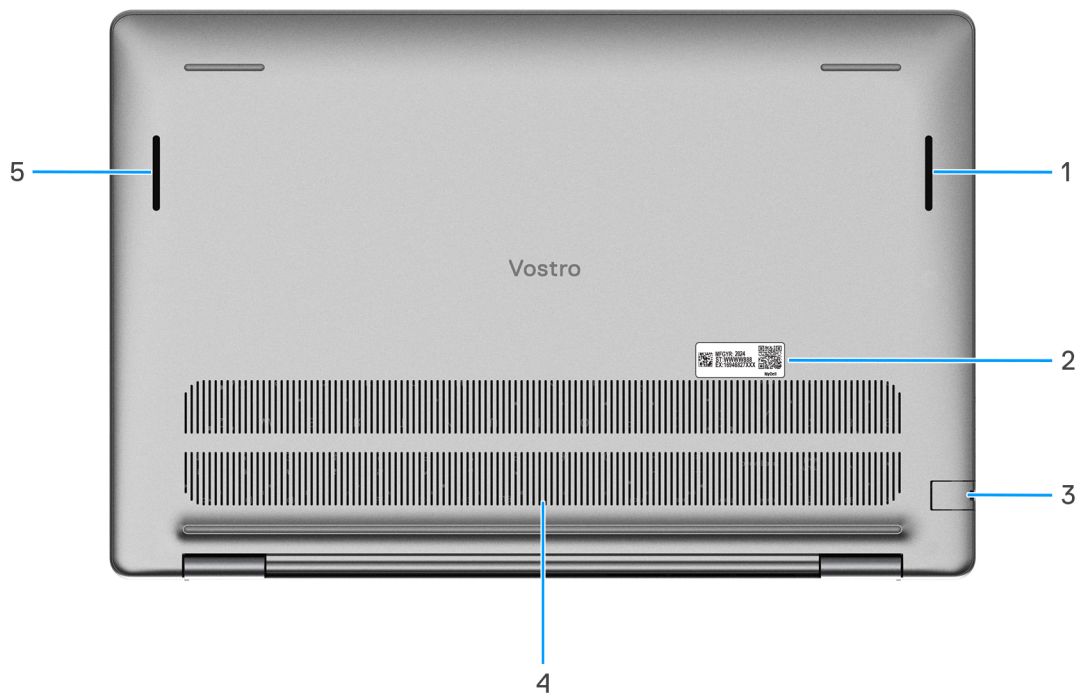

Figure 6. Bottom view

## 1. Right speaker

Provides audio output.

## 2. Service Tag label

The Service Tag is a unique alphanumeric identifier that enables Dell service technicians to identify the hardware components in your computer and access warranty information.

## 3. Network port

Connect an Ethernet (RJ45) cable from a router or a broadband modem for network or Internet access, with a transfer rate of 10/100/1000 Mbps.

#### 4. Air vents

Air vents provide ventilation for your computer. Clogged air vents can cause overheating and can affect your computer's performance and potentially cause hardware issues. Keep the air vents clear of obstructions and clean them regularly to prevent the build-up of dust and dirt. For more information about cleaning air vents, search for articles in the Knowledge Base Resource at [www.dell.com/support](http://www.dell.com/support).

#### 5. Left speaker

Provides audio output.

## Service Tag

The service tag is a unique alphanumeric identifier that allows Dell service technicians to identify the hardware components in your computer and access warranty information.

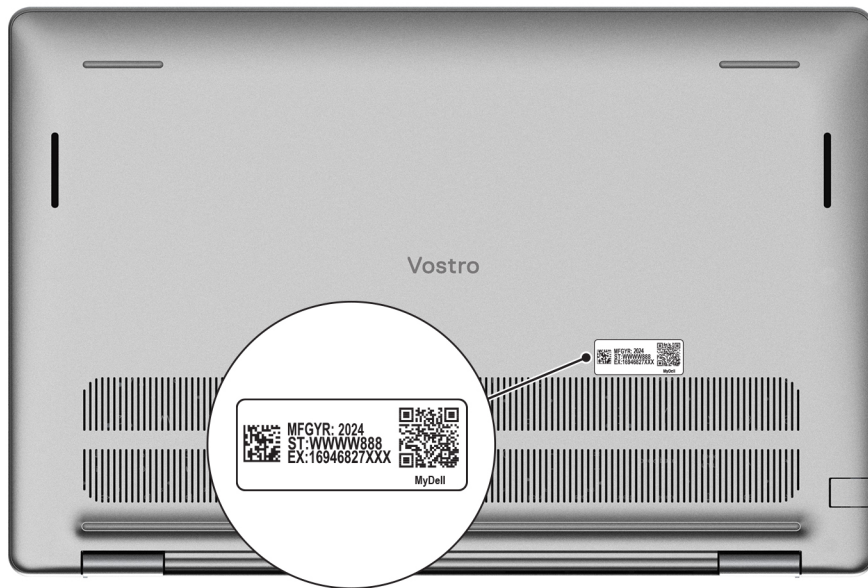

Figure 7. Service Tag

## Battery charge and status light

The following table lists the battery charge and status light behavior of your Vostro 16 5640.

Table 1. Battery charge and status light behavior

Power Source	LED Behavior	System Power State	Battery Charge Level
AC Adapter	Off	S0 - S5	Fully Charged
AC Adapter	Solid White	S0 - S5	< Fully Charged
Battery	Off	S0 - S5	11-100%
Battery	Solid Amber (590+/-3 nm)	S0 - S5	< 10%

- S0 (ON) - System is turned on.
- S4 (Hibernate) - The system consumes the least power compared to all other sleep states. The system is almost at an OFF state, except for a trickle power. The context data is written to a hard drive.
- S5 (OFF) - The system is in a shutdown state.

# Set up your Vostro 16 5640

## About this task

**NOTE:** The images in this document may differ from your computer depending on the configuration you ordered.

## Steps

1. Connect the power adapter and press the power button.



**NOTE:** The battery may go into power-saving mode during shipment to conserve charge on the battery. Ensure that the power adapter is connected to your computer when it is turned on for the first time.

2. Finish the operating system setup.

### For Ubuntu:

Follow the on-screen instructions to complete the setup. For more information about installing and configuring Ubuntu, search in the Knowledge Base Resource at [www.dell.com/support](http://www.dell.com/support).

### For Windows:

Follow the on-screen instructions to complete the setup. When setting up, Dell Technologies recommends that you:



- Connect to a network for Windows updates.

**NOTE:** If connecting to a secured wireless network, enter the password for the wireless network access when prompted.



- If connected to the Internet, sign in with or create a Microsoft account. If not connected to the Internet, create an offline account.
- On the **Support and Protection** screen, enter your contact details.

3. Locate and use Dell apps from the Windows Start menu—Recommended.



**Table 2. Locate Dell apps in Windows in S-mode**

Resources	Description
 <p><b>Figure 8. Dell Product Registration</b></p>	<p><b>Dell Product Registration</b></p> <p>Register your computer with Dell.</p>
 <p><b>Figure 9. Dell Help &amp; Support</b></p>	<p><b>Dell Help &amp; Support</b></p> <p>Access help and support for your computer.</p>
 <p><b>Figure 10. SupportAssist</b></p>	<p><b>SupportAssist</b></p> <p>SupportAssist proactively and predictively identifies hardware and software issues on your computer and automates the engagement process with Dell Technical support. It addresses performance and stabilization issues, prevents security threats, monitors, and detects hardware failures. For more information, see <i>SupportAssist for Home PCs User's Guide</i> at <a href="http://www.dell.com/support/home/product-support/product/dell-supportassist-pcs-tablets/docs">www.dell.com/support/home/product-support/product/dell-supportassist-pcs-tablets/docs</a>.</p> <p><b>NOTE:</b> In SupportAssist, click the warranty expiry date to renew or upgrade your warranty.</p>

**Table 3. Locate Dell apps in Windows**

Resources	Description
 <p><b>Figure 11. My Dell</b></p>	<p><b>My Dell</b></p> <p>MyDell is a software application that offers you a single streamlined engagement platform including account access, device information, and hardware settings. This software delivers intelligent features that automatically fine-tune your computer for the best possible audio, power, and performance. Get the most out of your Dell device with intelligent, personalized technology from MyDell. Following are the key features of MyDell:</p> <ul style="list-style-type: none"> <li>● Application</li> <li>● Audio</li> <li>● Power</li> <li>● Color and Display</li> <li>● Presence detection</li> </ul> <p>For more information about how to use MyDell, see product guides at <a href="http://www.dell.com/support">www.dell.com/support</a>.</p>
 <p><b>Figure 12. Dell Update</b></p>	<p><b>Dell Update</b></p> <p>Updates your computer with critical fixes and latest device drivers as they become available. For more information about using Dell Update, see the product guides and third-party license documents at <a href="http://www.dell.com/support">www.dell.com/support</a>.</p>

**Table 3. Locate Dell apps in Windows (continued)**

Resources	Description
 <p data-bbox="145 392 328 448"><b>Figure 13. Dell Digital Delivery</b></p>	<p data-bbox="400 309 639 338"><b>Dell Digital Delivery</b></p> <p data-bbox="400 351 1453 436">Download software applications, which are purchased but not preinstalled on your computer. For more information about using Dell Digital Delivery, search in the Knowledge Base Resource at <a href="http://www.dell.com/support">www.dell.com/support</a>.</p>
 <p data-bbox="145 640 368 696"><b>Figure 14. Support Assist</b></p>	<p data-bbox="400 504 576 533"><b>SupportAssist</b></p> <p data-bbox="400 546 1445 687">SupportAssist proactively and predictively identifies hardware and software issues on your computer and automates the engagement process with Dell Technical support. It addresses performance and stabilization issues, prevents security threats, monitors, and detects hardware failures. For more information, see <i>SupportAssist for Home PCs User's Guide</i> at <a href="http://www.dell.com/support/home/product-support/product/dell-supportassist-pcs-tablets/docs">www.dell.com/support/home/product-support/product/dell-supportassist-pcs-tablets/docs</a>.</p> <p data-bbox="400 701 1437 739"> <b>NOTE:</b> In SupportAssist, click the warranty expiry date to renew or upgrade your warranty.</p>

# Specifications of Vostro 16 5640

## Dimensions and weight

The following table lists the height, width, depth, and weight of your Vostro 16 5640.

**Table 4. Dimensions and weight**

Description	Values
Height:	
Front height	16.18 mm (0.63 in.)
Rear height	17.37 mm (0.68 in.)
Width	356.78 mm (14.04 in.)
Depth	249.52 mm (9.82 in.)
Weight  <b>NOTE:</b> The weight of your computer depends on the configuration that is ordered and manufacturing variability.	<ul style="list-style-type: none"> <li>• Minimum: 1.96 kg (4.32 lb)</li> <li>• Maximum: 1.98 kg (4.36 lb)</li> </ul>

## Processor

The following table lists the details of the processors that are supported for your Vostro 16 5640.

**Table 5. Processor**

Description	Option one	Option two	Option three
Processor type	Intel Core 5 1334U	Intel Core 5 120U	Intel Core 7 150U
Processor wattage	15 W	15 W	15 W
Processor total core count	10	10	10
Performance-cores	2	2	2
Efficient-cores	8	8	8
Processor total thread count  <b>NOTE:</b> Intel Hyper-Threading Technology is only available on Performance-cores.	12	12	12
Processor speed	Up to 4.60 GHz	up to 5 GHz	Up to 5.40 GHz
Performance-cores frequency			
Processor base frequency	1.30 GHz	1.40 GHz	1.80 GHz

**Table 5. Processor (continued)**

Description		Option one	Option two	Option three
	Maximum turbo frequency	4.60 GHz	5 GHz	5.40 GHz
Efficient-cores frequency				
	Processor base frequency	0.90 GHz	0.90 GHz	1.20 GHz
	Maximum turbo frequency	3.40 GHz	3.80 GHz	4 GHz
Thermal Mode/Thermal Design Power (TDP)				
	Cool	10 W	10 W	10 W
	Optimized	15 W	15 W	15 W
	Quiet	10 W	10 W	10 W
	Ultra Performance	17 W	17 W	17 W
	<b>NOTE:</b> Processor clock speeds and thermal design power differ according to the thermal mode selected in the My Dell app on your computer.			
	Processor cache	12 MB	12 MB	12 MB
	Integrated graphics	Intel Graphics	Intel Graphics	Intel Graphics

## Chipset

The following table lists the details of the chipset that is supported for your Vostro 16 5640.

**Table 6. Chipset**

Description	Values
Chipset	Integrated with the processor
Processor	<ul style="list-style-type: none"> <li>• Intel Core 5 120U</li> <li>• Intel Core 5 1334U</li> <li>• Intel Core 7 150U</li> </ul>
DRAM bus width	Two channels, 64-bit
Flash EPROM	32 MB
PCIe bus	Up to Gen4

## Operating system

Your Vostro 16 5640 supports the following operating systems:

- Windows 11 Home
- Windows 11 Home (S Mode)
- Windows 11 Pro
- Windows 11 Pro National Academic
- Ubuntu Linux 22.04 LTS



# Memory

The following table lists the memory specifications of your Vostro 16 5640.

**Table 7. Memory specifications**

Description	Values
Memory slots	Two SODIMM
Memory type	DDR5
Memory speed	5200 MT/s
Maximum memory configuration	32 GB
Minimum memory configuration	8 GB
Memory size per slot	8 GB, 16 GB, or 24 GB
Memory configurations supported	<ul style="list-style-type: none"><li>• 8 GB: 1 x 8 GB, DDR5, 5200 MT/s, single-channel</li><li>• 16 GB: 2 x 8 GB, DDR5, 5200 MT/s, dual-channel</li><li>• 24 GB: 1 x 8 GB + 1 x 16 GB, DDR5, 5200 MT/s, dual-channel</li><li>• 32 GB: 2 x 16 GB, DDR5, 5200 MT/s, dual-channel</li></ul>

# External ports

The following table lists the external ports of your Vostro 16 5640.

**Table 8. External ports**

Description	Values
Network port	One RJ45 port
USB ports	<ul style="list-style-type: none"><li>• Two USB 3.2 Gen 1 (5 Gbps) ports</li><li>• One USB 3.2 Gen 2 (10 Gbps) Type-C with DisplayPort AltMode1.4 and PowerDelivery port</li></ul>
Audio port	One Universal Audio jack
Video port	<ul style="list-style-type: none"><li>• One HDMI 1.4 port</li><li>• One USB 3.2 Gen 2 (10 Gbps) Type-C with DisplayPort AltMode1.4 and PowerDelivery port</li></ul>
Media-card reader	One SD-card slot
Power-adaptor port	One power-adaptor port
Security-cable slot	One wedge-shaped lock slot

## Internal slots

The following table lists the internal slots of your Vostro 16 5640.

**Table 9. Internal slots**

Description	Values
M.2	<ul style="list-style-type: none"><li>One M.2 2230 slot for Wi-Fi and Bluetooth combo card</li><li>One M.2 2230 slot for solid-state drive</li></ul> <p><b>NOTE:</b> To learn more about the features of different types of M.2 cards, search in the Knowledge Base Resource at <a href="http://www.dell.com/support">www.dell.com/support</a>.</p>

## Ethernet

The following table lists the wired Ethernet Local Area Network (LAN) specifications of your Vostro 16 5640.

**Table 10. Ethernet specifications**

Description	Values
Model number	Realtek RTL8111H
Transfer rate	10/100/1000 Mbps

## Wireless module

The following table lists the Wireless Local Area Network (WLAN) module that is supported on your Vostro 16 5640.

**Table 11. Wireless module specifications**

Description	Values
Model number	Realtek RTL8852BE
Transfer rate	1201 Mbps
Frequency bands supported	2.4 GHz/5 GHz
Wireless standards	<ul style="list-style-type: none"><li>Wi-Fi 802.11a/b/g</li><li>Wi-Fi 4 (WiFi 802.11n)</li><li>Wi-Fi 5 (WiFi 802.11ac)</li><li>Wi-Fi 6 (WiFi 802.11ax)</li></ul>
Encryption	<ul style="list-style-type: none"><li>64-bit/128-bit WEP</li><li>AES-CCMP</li><li>TKIP</li></ul>
Bluetooth wireless card	Bluetooth 5.3
	<p><b>NOTE:</b> The version of the Bluetooth wireless card may vary depending on the operating system that is installed on your computer.</p>

## Audio

The following table lists the audio specifications of your Vostro 16 5640.

**Table 12. Audio specifications**

Description	Values
Audio controller	Realtek ALC3254
Stereo conversion	Supported
Internal audio interface	High definition audio interface
External audio interface	One Universal Audio port
Number of speakers	2 W per channel
Internal-speaker amplifier	Supported
External volume controls	Keyboard shortcut controls
Speaker output:	
Average speaker output	2 W
Peak speaker output	2.5 W
Subwoofer output	Not supported
Microphone	<ul style="list-style-type: none"><li>• Single integrated microphone (for computers shipped with a plastic chassis)</li><li>• Dual-array microphones (for computers shipped with an aluminum chassis)</li></ul>

## Storage

This section lists the storage options on your Vostro 16 5640.

Your Vostro 16 5640 supports only one M.2 2230 solid-state drive.

**Table 13. Storage specifications**

Storage type	Interface type	Capacity
M.2 2230 PCIe NVMe Class 35 solid-state drive	Gen4 PCIe NVMe	Up to 1 TB
M.2 2230 PCIe NVMe Class 25 solid-state drive	Gen4 PCIe NVMe	Up to 1 TB

## Media-card reader

The following table lists the media cards that are supported on your Vostro 16 5640.

**Table 14. Media-card reader specifications**

Description	Values
Media-card type	One SD card slot

**Table 14. Media-card reader specifications (continued)**

Description	Values
Media-cards supported	<ul style="list-style-type: none"><li>Secure Digital (SD)</li><li>Secure Digital High Capacity (SDHC)</li><li>Secure Digital Extended Capacity (SDXC)</li></ul>
<b>i</b> <b>NOTE:</b> The maximum capacity supported by the media-card reader varies depending on the standard of the media card that is installed on your computer.	

## Keyboard

The following table lists the keyboard specifications of your Vostro 16 5640.

**Table 15. Keyboard specifications**

Description	Values
Keyboard type	Standard AI hotkey backlit keyboard
Keyboard layout	QWERTY
Number of keys	<ul style="list-style-type: none"><li>English International, Arabic, Chinese (Traditional), Greek, Hebrew, Ukrainian: 99 keys</li><li>Czech/Slovakian (MUI), English UK, Nordic (MUI), Slovenian: 100 keys</li></ul>
Keyboard size	X= 18.70 mm key pitch Y= 18.05 mm key pitch
Keyboard shortcuts	Some keys on your keyboard have two symbols on them. These keys can be used to type alternate characters or to perform secondary functions. To type the alternate character, press Shift and the desired key. To perform secondary functions, press Fn and the desired key. <b>i</b> <b>NOTE:</b> You can define the primary behavior of the function keys (F1–F12) changing <b>Function Key Behavior</b> in BIOS setup program.

## Keyboard function keys

**i** **NOTE:** Keyboard characters may differ depending on the keyboard language configuration. Keys that are used for shortcuts remain the same across all language configurations.

Some keys on your keyboard have two symbols on them. These keys can be used to type alternate characters or to perform secondary functions. The symbol that is shown on the lower part of the key refers to the character that is typed out when the key is pressed. If you press shift and the key, the symbol that is shown on the upper part of the key is typed out. For example, if you press 2, **2** is typed out; if you press Shift + 2, **@** is typed out.

The keys F1-F12 at the top row of the keyboard are function keys for multimedia control, as indicated by the icon on the key. Press the function key to invoke the task represented by the icon. For example, pressing F1 mutes the audio (see the table below).

However, if the function keys F1-F12 are needed for specific software applications, multimedia functionality can be disabled by pressing Fn + Esc. Later, multimedia control can be invoked by pressing Fn and the respective function key. For example, mute audio by pressing Fn + F1.

**Table 16. Primary behavior of function keys**

Function key	Primary behavior
F1	Mute/unmute audio
F2	Decrease audio volume
F3	Increase audio volume
F4	Play or pause media file
F5	Turn on or turn off keyboard backlight
F6	Decrease display brightness
F7	Increase display brightness
F8	Switch to an external display
F10	Print screen (Screen capture)
F11	Home
F12	End

The **Fn** key is also used with selected keys on the keyboard to invoke other secondary functions.

**Table 17. Secondary behavior**

Function key	Secondary behavior
Fn + F1	Operating system and application-specific F1 behavior
Fn + F2	Operating system and application-specific F2 behavior
Fn + F3	Operating system and application-specific F3 behavior
Fn + F4	Operating system and application-specific F4 behavior
Fn + F5	Operating system and application-specific F5 behavior
Fn + F6	Operating system and application-specific F6 behavior
Fn + F8	Operating system and application-specific F8 behavior
Fn + F9	Operating system and application-specific F9 behavior
Fn + F10	Operating system and application-specific F10 behavior
Fn + F11	Operating system and application-specific F11 behavior
Fn + F12	Operating system and application-specific F12 behavior
Fn + B	Pause or Break
Fn + S	Toggle scroll lock
Fn + R	System request
Fn + Ctrl	Open the application menu
Fn + Esc	Toggle between multimedia and function key behavior on and off
Fn + PgUp	Scroll up the document or page
Fn + PgDn	Scroll down the document or page
Fn + left arrow	Home (move to the beginning of the document)
Fn + right arrow	End (move to the end of the document)

# Camera

The following table lists the camera specifications of your Vostro 16 5640.

**Table 18. Camera specifications**

Description		Values
Number of cameras		One
Camera type		RGB FHD camera
Camera location		Front camera
Camera sensor type		CMOS sensor technology
Camera resolution:		
	Still image	2.07 megapixel
	Video	1920 x 1080 (FHD @ 30 fps)
Diagonal viewing angle:		82.20 degrees

# Touchpad

The following table lists the touchpad specifications of your Vostro 16 5640.

**Table 19. Touchpad specifications**

Description		Values
Touchpad resolution:		
	Horizontal	305
	Vertical	305
Touchpad dimensions:		
	Horizontal	115 mm (4.52 in.)
	Vertical	80 mm (3.15 in.)
Touchpad gestures		For more information about touchpad gestures available on Windows, see the Microsoft Knowledge Base article at <a href="https://support.microsoft.com">support.microsoft.com</a> .

# Power adapter

The following table lists the power adapter specifications of your Vostro 16 5640.

**Table 20. Power adapter specifications**

Description		Values
Type		65W
Connector dimensions:		
	External diameter	4.50 mm

**Table 20. Power adapter specifications (continued)**

Description		Values
	Internal diameter	2.90 mm
Power-adapter dimensions:		
	Height	28 mm (1.10 in.)
	Width	47 mm (1.90 in.)
	Depth	108 mm (4.30 in.)
Power-adapter weight (maximum)		0.29 kg (0.64 lb)
Input voltage		100 VAC – 240 VAC
Input frequency		50 Hz – 60 Hz
Input current (maximum)		1.70 A
Output current (continuous)		3.34 A
Rated output voltage		19.50 VDC
Temperature range:		
	Operating	0°C to 40°C (32°F to 104°F)
	Storage	-40°C to 70°C (-40°F to 158°F)
 <b>CAUTION: Operating and storage temperature ranges may differ among components, so operating or storing the device outside these ranges may impact the performance of specific components.</b>		

## Battery

The following table lists the battery specifications of your Vostro 16 5640.

**Table 21. Battery specifications**

Description		Values
Battery type		4-cell, 54 Wh, Lithium Ion Polymer, ExpressCharge Capable
Battery voltage		15 VDC
Battery weight (maximum)		0.24 kg (0.53 lb)
Battery dimensions:		
	Height	5.75 mm (0.22 in.)
	Width	271.90 mm (10.66 in.)
	Depth	82 mm (3.22 in.)
Temperature range:		
	Operating	0°C to 50°C (32°F to 122°F)
	Storage	-20°C to 60°C (-4°F to 140°F)

**Table 21. Battery specifications (continued)**

Description	Values
Battery operating time	Varies depending on operating conditions and can significantly reduce under certain power-intensive conditions.
Battery charging time (approximate) <i>i</i> <b>NOTE:</b> Control the charging time, duration, start and end time, and so on, using the Dell Power Manager application. For more information about Dell Power Manager, search in the Knowledge Base Resource at <a href="http://www.dell.com/support">www.dell.com/support</a> .	<ul style="list-style-type: none"> <li>• 3hr (Standard charge)</li> <li>• 2hr (Express charge )</li> </ul>
Coin-cell battery	Not supported
<p><b>⚠ CAUTION: Operating and storage temperature ranges may differ among components, so operating or storing the device outside these ranges may impact the performance of specific components.</b></p> <p><b>⚠ CAUTION: Dell Technologies recommends that you charge the battery regularly for optimal power consumption. If your battery charge is depleted, connect the power adapter, turn on your computer, and then restart your computer to reduce the power consumption.</b></p>	

## Display

The following table lists the display specifications of your Vostro 16 5640.

**Table 22. Display specifications**

Description	Option one	Option two
Display type	16" Full High Definition Plus (FHD+)	16" 2.5K
Touch options	No	No
Display-panel technology	Wide Viewing Angle (WVA)	Wide Viewing Angle (WVA)
Display-panel dimensions (active area):		
Height	344.68 mm	344.68 mm
Width	215.42 mm	215.42 mm
Diagonal	406.46 mm	406.46 mm
Display-panel native resolution	1920 x 1200	2560 x 1600
Luminance (typical)	250 nit	300 nit
Megapixels	2.30 M	4.10 M
Color gamut	45% NTSC	100% sRGB
Pixels Per Inch (PPI)	141	189
Contrast ratio (minimum)	<ul style="list-style-type: none"> <li>• 1000:1 (typical)</li> <li>• 800:1 (minimum)</li> </ul>	<ul style="list-style-type: none"> <li>• 1200:1 (typical)</li> <li>• 1000:1 (minimum)</li> </ul>
Response time (maximum)	25 millisecond	35 millisecond
Refresh rate	60 Hz	120 Hz



**Table 22. Display specifications (continued)**

Description	Option one	Option two
Horizontal view angle	<ul style="list-style-type: none"> <li>+/- 85 degrees, typical</li> <li>+/- 80 degrees, minimum</li> </ul>	<ul style="list-style-type: none"> <li>+/- 85 degrees, typical</li> <li>+/- 80 degrees, minimum</li> </ul>
Vertical view angle	<ul style="list-style-type: none"> <li>+/- 85 degrees, typical</li> <li>+/- 80 degrees, minimum</li> </ul>	<ul style="list-style-type: none"> <li>+/- 85 degrees, typical</li> <li>+/- 80 degrees, minimum</li> </ul>
Pixel pitch	0.18 mm	0.13 mm
Power consumption (maximum)	4.2W	4W
Anti-glare vs glossy finish	Anti-glare	Anti-glare

## Fingerprint reader (optional)

The following table lists the specifications of the optional fingerprint-reader of your Vostro 16 5640.

**Table 23. Fingerprint reader specifications**

Description	Values
Fingerprint-reader sensor technology	Capacitive
Fingerprint-reader sensor resolution	500 dpi
Fingerprint-reader sensor pixel size	108 x 88

## Sensor

The following table lists the sensor of your Vostro 16 5640.

**Table 24. Sensor**

Sensor support
Adaptive Thermal Performance Accelerometer

## GPU—Integrated

The following table lists the specifications of the integrated Graphics Processing Unit (GPU) supported by your Vostro 16 5640.

**Table 25. GPU—Integrated**

Controller	Memory size	Processor
Intel Graphics	Shared system memory	Intel Core 5 and Core 7 processors

## Multiple display support matrix

The following table lists the multiple display support matrix for your Vostro 16 5640.

**Table 26. Multiple display support matrix**

Graphics Card	Direct Graphics Controller Direct Output Mode	Supported external displays with computer internal display on	Supported external displays with computer internal display off
Intel Graphics	Not supported	2	2

## Hardware security

The following table lists the hardware security of your Vostro 16 5640.

**Table 27. Hardware security**

Hardware security
Windows 11 Hello - Fingerprint Reader (optional)
Trusted Platform Module (TPM) 2.0
Wedge-shaped lock

## Operating and storage environment

This table lists the operating and storage specifications of your Vostro 16 5640.

**Airborne contaminant level:** G1 as defined by ISA-S71.04-1985

**Table 28. Computer environment**

Description	Operating	Storage
Temperature range	0 °C to 40°C (32 °F to 104°F)	-40°C to 65°C (-40°F to 149°F)
Relative humidity (maximum)	10% to 90% (non-condensing)	0% to 95% (non-condensing)
Vibration (maximum)*	0.66 GRMS	1.30 GRMS
Shock (maximum)	140 G†	160 G†
Altitude range	Not applicable	-15.2 m to 10668 m (-49.87 ft to 35000 ft)

**CAUTION:** Operating and storage temperature ranges may differ among components, so operating or storing the device outside these ranges may impact the performance of specific components.

\* Measured using a random vibration spectrum that simulates the user environment.

† Measured using a 2 ms half-sine pulse.

## ComfortView

**WARNING:** Prolonged exposure to blue light from the display may lead to long-term effects such as eye strain, eye fatigue, or damage to the eyes.

Blue light is a color in the light spectrum which has a short wavelength and high energy. Chronic exposure to blue light, particularly from digital sources may disrupt sleep patterns and cause long-term effects such as eye strain, eye fatigue, or damage to the eyes.

ComfortView mode can be enabled and configured using the Dell CinemaColor application.

ComfortView mode complies with TÜV Rheinland's requirement for low blue light displays.

Low blue light: Dell ComfortView software technology reduces harmful blue light emissions to make extended screen time easy on your eyes.

To reduce the risk of eye strain, it is also recommended that you:

- Position the display at a comfortable viewing distance between 20 and 28 inches (50 cm and 70 cm) from your eyes.
- Blink frequently to moisten your eyes, wet your eyes with water, or apply suitable eye drops.
- Look away from your display, and gaze at a distant object at 20 ft (609.60 cm) away for at least 20 seconds during each break.
- Take an extended break for 20 minutes every two hours.

## ComfortView Plus

 **WARNING: Prolonged exposure to blue light from the display may lead to long-term effects such as eye strain, eye fatigue, or damage to the eyes.**

Blue light is a color in the light spectrum which has a short wavelength and high energy. Chronic exposure to blue light, particularly from digital sources may disrupt sleep patterns and cause long-term effects such as eye strain, eye fatigue, or damage to the eyes.

The display on this computer is designed to minimize blue light and complies with TÜV Rheinland's requirement for low blue light displays.

Low blue light mode is enabled at the factory, so no further configuration is necessary.











To reduce the risk of eye strain, it is also recommended that you:

- Position the display at a comfortable viewing distance between 20 and 28 inches (50 cm and 70 cm) from your eyes.
- Blink frequently to moisten your eyes, wet your eyes with water, or apply suitable eye drops.
- Look away from your display, and gaze at a distant object at 20 ft (609.60 cm) away for at least 20 seconds during each break.
- Take an extended break for 20 minutes every two hours.

# Working inside your computer



## Safety instructions

Use the following safety guidelines to protect your computer from potential damage and to ensure your personal safety. Unless otherwise noted, each procedure in this document assumes that you have read the safety information that shipped with your computer.

-  **WARNING:** Before working inside your computer, read the safety information that is shipped with your computer. For more safety best practices, see the Regulatory Compliance home page at [www.dell.com/regulatory\\_compliance](http://www.dell.com/regulatory_compliance).
-  **WARNING:** Disconnect your computer from all power sources before opening the computer cover or panels. After you finish working inside the computer, replace all covers, panels, and screws before connecting your computer to an electrical outlet.
-  **CAUTION:** To avoid damaging the computer, ensure that the work surface is flat, dry, and clean.
-  **CAUTION:** To avoid damaging the components and cards, handle them by their edges, and avoid touching the pins and the contacts.
-  **CAUTION:** You should only perform troubleshooting and repairs as authorized or directed by the Dell technical assistance team. Damage due to servicing that is not authorized by Dell is not covered by your warranty. See the safety instructions that is shipped with the product or at [www.dell.com/regulatory\\_compliance](http://www.dell.com/regulatory_compliance).
-  **CAUTION:** Before touching anything inside your computer, ground yourself by touching an unpainted metal surface, such as the metal at the back of the computer. While you work, periodically touch an unpainted metal surface to dissipate static electricity which could harm internal components.
-  **CAUTION:** When you disconnect a cable, pull it by its connector or its pull tab, not the cable itself. Some cables have connectors with locking tabs or thumbscrews that you must disengage before disconnecting the cable. When disconnecting cables, keep them evenly aligned to avoid bending the connector pins. When connecting cables, ensure that the ports and the connectors are correctly oriented and aligned.
-  **CAUTION:** Press and eject any installed card from the media-card reader.
-  **CAUTION:** Exercise caution when handling rechargeable Li-ion batteries in laptops. Swollen batteries should not be used and should be replaced and disposed properly.
-  **NOTE:** The color of your computer and certain components may differ from what is shown in this document.

## Before working inside your computer

### Steps

1. Save and close all open files and exit all open applications.
2. Shut down your computer. For Windows operating system, click **Start** >  **Power** > **Shut down**.
  -  **NOTE:** If you are using a different operating system, see the documentation of your operating system for shut-down instructions.
3. Disconnect your computer and all attached devices from their electrical outlets.
4. Disconnect all attached network devices and peripherals, such as keyboard, mouse, and monitor from your computer.

5. Remove any media card and optical disk from your computer, if applicable.
6. Enter the service mode, if you can turn on your computer.

### Service Mode

Service Mode is used to cut off power, without disconnecting the battery cable from the system board prior to conducting repairs in the computer.

 **CAUTION:** If you are unable to turn on the computer to put it into Service Mode, or the computer does not support Service Mode, proceed to disconnect the battery cable. To disconnect the battery cable, follow the steps in [Removing the battery](#).

 **NOTE:** Ensure that your computer is shut down and the AC adapter is disconnected.

- a. Hold the **<B>** key on the keyboard and press the power button for 3 seconds or until the Dell logo appears on the screen.
- b. Press any key to continue.
- c. If the AC adapter is not disconnected, a message prompting you to remove the AC adapter appears on the screen. Remove the AC adapter and then press any key to continue the **Service Mode** process. The **Service Mode** process automatically skips the following step if the **Owner Tag** of the computer is not set up in advance by the user.
- d. When the **ready-to-proceed** message appears on the screen, press any key to proceed. The computer emits three short beeps and shuts down immediately.
- e. Once the computer shuts down, it has successfully entered Service Mode.

 **NOTE:** If you are unable to turn on your computer or unable to enter Service Mode, skip this process.

## Safety precautions

The safety precautions chapter details the primary steps to be taken before performing any disassembly instructions.

Observe the following safety precautions before you perform any installation or break-fix procedures involving disassembly or reassembly:

- Turn off the computer and all attached peripherals.
- Disconnect the computer and all attached peripherals from AC power.
- Disconnect all network cables, telephone, and telecommunications lines from the computer.
- Use an ESD field service kit when working inside any notebook to avoid electrostatic discharge (ESD) damage.
- After removing any computer component, carefully place the removed component on an anti-static mat.
- Wear shoes with non-conductive rubber soles to reduce the chance of getting electrocuted.
- Unplugging, pressing, and holding the power button for 15 seconds should discharge residual power in the system board.

## Standby power

Dell products with standby power must be unplugged before you open the case. Systems that incorporate standby power are powered while turned off. The internal power enables the computer to be remotely turned on (Wake-on-LAN) and suspended into a sleep mode and has other advanced power management features.

## Bonding

Bonding is a method for connecting two or more grounding conductors to the same electrical potential. This is done by using a field service electrostatic discharge (ESD) kit. When connecting a bonding wire, ensure that it is connected to bare metal and never to a painted or nonmetal surface. The wrist strap should be secure and in full contact with your skin, and ensure that you remove all jewelry such as watches, bracelets, or rings prior to bonding yourself and the equipment.

## Electrostatic discharge—ESD protection

ESD is a major concern when you handle electronic components, especially sensitive components such as expansion cards, processors, memory modules, and system boards. Slight charges can damage circuits in ways that may not be obvious, such as intermittent problems or a shortened product life span. As the industry pushes for lower power requirements and increased density, ESD protection is an increasing concern.

Due to the increased density of semiconductors used in recent Dell products, the sensitivity to static damage is now higher than in previous Dell products. For this reason, some previously approved methods of handling parts are no longer applicable.

Two recognized types of ESD damage are catastrophic and intermittent failures.

- **Catastrophic** – Catastrophic failures represent approximately 20 percent of ESD-related failures. The damage causes an immediate and complete loss of device functionality. An example of catastrophic failure is a memory DIMM that has received a static shock and immediately generates a "No POST/No Video" symptom with a beep code that is emitted for missing or nonfunctional memory.
- **Intermittent** – Intermittent failures represent approximately 80 percent of ESD-related failures. The high rate of intermittent failures means that most of the time when damage occurs, it is not immediately recognizable. The DIMM receives a static shock, but the tracing is merely weakened and does not immediately produce outward symptoms that are related to the damage. The weakened trace may take weeks or months to melt, and in the meantime may cause degradation of memory integrity, intermittent memory errors, and so on.

The more difficult type of damage to recognize and troubleshoot is the intermittent (also called latent or "walking wounded") failure.

Perform the following steps to prevent ESD damage:

- Use a wired ESD wrist strap that is properly grounded. Wireless anti-static straps do not provide adequate protection. Touching the chassis before handling parts does not ensure adequate ESD protection on parts with increased sensitivity to ESD damage.
- Handle all static-sensitive components in a static-safe area. If possible, use anti-static floor pads and workbench pads.
- When unpacking a static-sensitive component from its shipping carton, do not remove the component from the anti-static packing material until you are ready to install the component. Before unwrapping the anti-static packaging, ensure that you discharge static electricity from your body.
- Before transporting a static-sensitive component, place it in an anti-static container or packaging.

## ESD Field Service kit

The unmonitored Field Service kit is the most commonly used service kit. Each Field Service kit includes three main components: anti-static mat, wrist strap, and bonding wire.

### Components of an ESD field service kit

The components of an ESD field service kit are:

- **Anti-Static Mat** – The anti-static mat is dissipative and parts can be placed on it during service procedures. When using an anti-static mat, your wrist strap should be snug and the bonding wire should be connected to the mat and to any bare metal on the computer being worked on. Once deployed properly, service parts can be removed from the ESD bag and placed directly on the mat. ESD-sensitive items are safe in your hand, on the ESD mat, in the computer, or inside an ESD bag.
- **Wrist Strap and Bonding Wire** – The wrist strap and bonding wire can be either directly connected between your wrist and bare metal on the hardware if the ESD mat is not required, or connected to the anti-static mat to protect hardware that is temporarily placed on the mat. The physical connection of the wrist strap and bonding wire between your skin, the ESD mat, and the hardware is known as bonding. Use only Field Service kits with a wrist strap, mat, and bonding wire. Never use wireless wrist straps. Always be aware that the internal wires of a wrist strap are prone to damage from normal wear and tear, and must be checked regularly with a wrist strap tester in order to avoid accidental ESD hardware damage. It is recommended to test the wrist strap and bonding wire at least once per week.
- **ESD Wrist Strap Tester** – The wires inside an ESD strap are prone to damage over time. When using an unmonitored kit, it is a best practice to regularly test the strap prior to each service call, and at a minimum, test once per week. A wrist strap tester is the best method for doing this test. If you do not have your own wrist strap tester, check with your regional office to find out if they have one. To perform the test, plug the bonding-wire of wrist-strap into the tester while it is strapped to your wrist and push the button to test. A green LED is lit if the test is successful; a red LED is lit and an alarm sounds if the test fails.
- **Insulator Elements** – It is critical to keep ESD sensitive devices, such as plastic heat sink casings, away from internal parts that are insulators and often highly charged.
- **Working Environment** – Before deploying the ESD Field Service kit, assess the situation at the customer location. For example, deploying the kit for a server environment is different than for a desktop or laptop environment. Servers are typically installed in a rack within a data center; desktops or laptops are typically placed on office desks or cubicles. Always look for a large open flat work area that is free of clutter and large enough to deploy the ESD kit with additional space to accommodate the type of computer that is being repaired. The workspace should also be free of insulators that can cause an ESD event. On the work area, insulators such as Styrofoam and other plastics should always be moved at least 12 inches or 30 centimeters away from sensitive parts before physically handling any hardware components.

- **ESD Packaging** – All ESD-sensitive devices must be shipped and received in static-safe packaging. Metal, static-shielded bags are preferred. However, you should always return the damaged part using the same ESD bag and packaging that the new part arrived in. The ESD bag should be folded over and taped shut and all the same foam packing material should be used in the original box that the new part arrived in. ESD-sensitive devices should be removed from packaging only at an ESD-protected work surface, and parts should never be placed on top of the ESD bag because only the inside of the bag is shielded. Always place parts in your hand, on the ESD mat, in the computer, or inside an anti-static bag.
- **Transporting Sensitive Components** – When transporting ESD sensitive components such as replacement parts or parts to be returned to Dell, it is critical to place these parts in anti-static bags for safe transport.

## ESD protection summary

It is recommended to always use the traditional wired ESD grounding wrist strap and protective anti-static mat when servicing Dell products. In addition, it is critical to keep sensitive parts separate from all insulator parts while performing service and use anti-static bags for transporting sensitive components.

## Transporting sensitive components

When transporting ESD sensitive components such as replacement parts or parts to be returned to Dell, it is critical to place these parts in anti-static bags for safe transport.

## After working inside your computer

### About this task

 **CAUTION:** Leaving stray or loose screws inside your computer may severely damage your computer.

### Steps

1. Replace all screws and ensure that no stray screws remain inside your computer.
2. Connect any external devices, peripherals, or cables you removed before working on your computer.
3. Replace any media cards, discs, or any other parts that you removed before working on your computer.
4. Connect your computer and all attached devices to their electrical outlets.
  -  **NOTE:** To exit service mode, ensure to connect the AC adapter to the power-adapter port on your computer.
5. Press the power button to turn on the computer. Your computer will automatically return to normal functioning mode.

## BitLocker

 **CAUTION:** If BitLocker is not suspended before updating the BIOS, the next time you reboot the system it will not recognize the BitLocker key. You will then be prompted to enter the recovery key to progress, and the system will ask for the recovery key on each reboot. If the recovery key is not known, this can result in data loss or an unnecessary operating system reinstall. For more information about this subject, see Knowledge Article: [updating the BIOS on Dell systems with BitLocker enabled](#).

The installation of the following components triggers BitLocker:

- Hard disk drive or solid-state drive
- System board

## Recommended tools













The procedures in this document may require the following tools:

- Phillips screwdriver #0
- Plastic scribe

# Screw list



- NOTE:** When removing screws from a component, it is recommended to note the screw type, and the quantity of screws, and then place them in a screw storage box. This is to ensure that the correct number of screws and correct screw type is restored when the component is replaced.
- NOTE:** Some computers have magnetic surfaces. Ensure that the screws are not left attached to such surfaces when replacing a component.
- NOTE:** Screw color may vary with the configuration ordered.

**Table 29. Screw list**

Component	Screw type	Quantity	Screw image
<b>CRU</b>			
Base cover	Captive screw	2	
	M2x5.5	6	
Solid state drive thermal plate	M2x3.5	3	
Solid state drive	M1.6x1.8	1	
Wireless card	M2x3.5	1	
Fan	M2x5.5	2	
<b>FRU</b>			
Battery	M2x3.5	5	
Heat sink	Captive screws	4	
Touchpad assembly	M2x2.3	7	
Hinges	M2.5x5	5 <b>NOTE:</b> Right hinge - 2 screws Left hinge - 3 screws	
I/O board	M2x3.5	3	
Power button	M2x2.3	1	
Power button with fingerprint reader (optional)	M2x2.3	1	

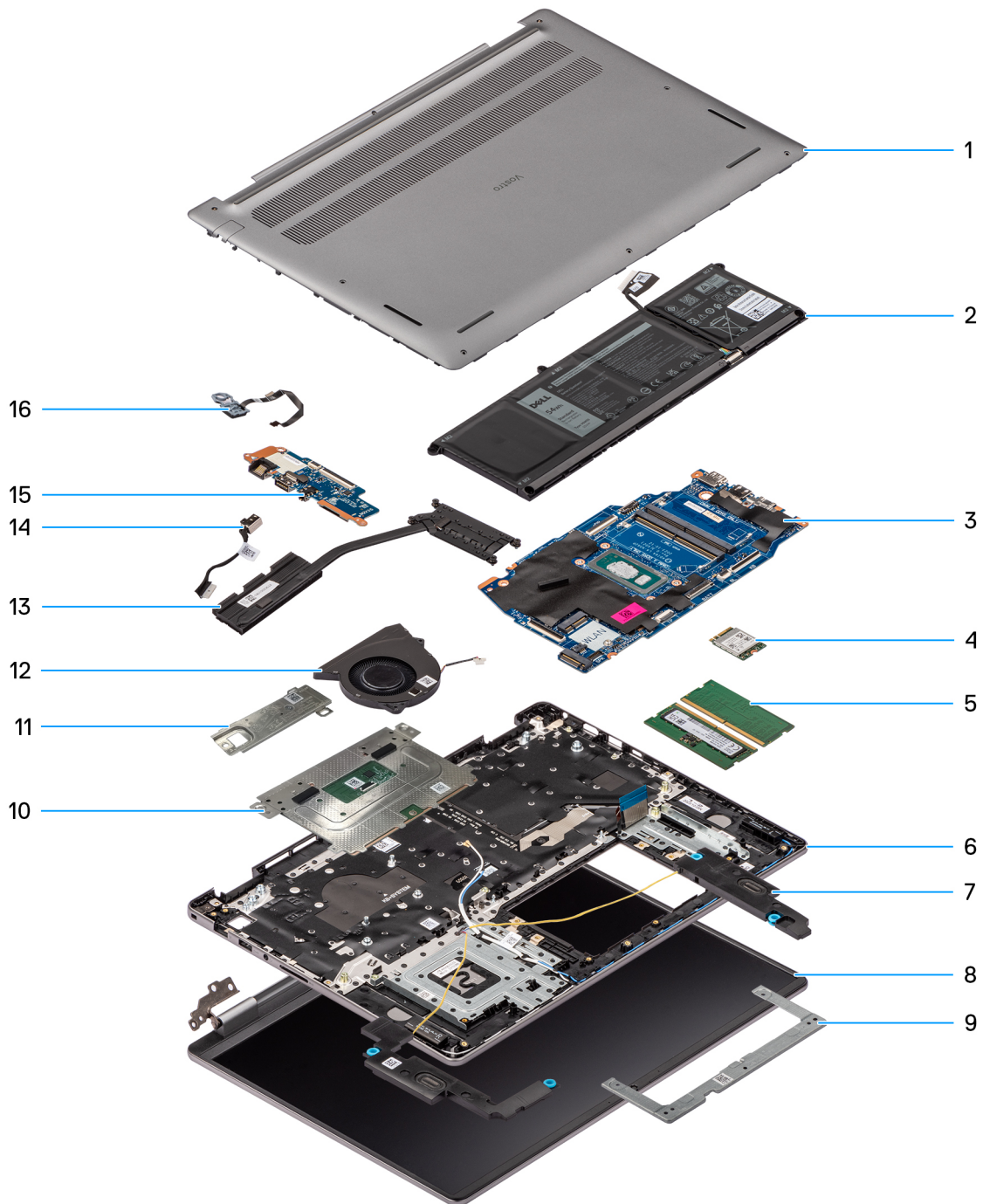

**Table 29. Screw list (continued)**

Component	Screw type	Quantity	Screw image
System board	M2x3.5	4	
	M1.6x1.8	1	
USB Type-C bracket <b>i</b> <b>NOTE:</b> A USB Type-C bracket is secured to the system board with a single (M2x3.5) screw. The bracket is bundled with the system board as a service part and <b>MUST NOT</b> be removed from the system board.	M2x3.5	1	

## Major components of Vostro 16 5640

The following image shows the major components of Vostro 16 5640.



**Figure 15. Major components of Vostro 16 5640**

1. Base cover
2. Battery
3. System board
4. Wireless card
5. Memory modules
6. Palm-rest and keyboard assembly
7. Speakers
8. Display assembly
9. Touchpad bracket
10. Touchpad assembly
11. M.2 2230 solid-state drive with thermal plate

12. Fan
13. Heat sink
14. Power-adaptor port
15. I/O board
16. Power button with optional fingerprint reader

 **NOTE:** Dell provides a list of components and their part numbers for the original computer configuration purchased. These parts are available according to warranty coverage purchased by the customer. Contact your Dell sales representative for purchase options.

# Removing and installing Customer Replaceable Units (CRUs)

The replaceable components in this chapter are Customer Replaceable Units (CRUs).

 **CAUTION:** Customers can replace only the Customer Replaceable Units (CRUs) following the safety precautions and replacement procedures.

 **NOTE:** The images in this document may differ from your computer depending on the configuration you ordered.

## Base cover

### Removing the base cover

#### Prerequisites

1. Follow the procedure in [Before working inside your computer](#).

#### About this task

The following images indicate the location of the base cover and provide a visual representation of the removal procedure.



2x



6x  
M2x5.5



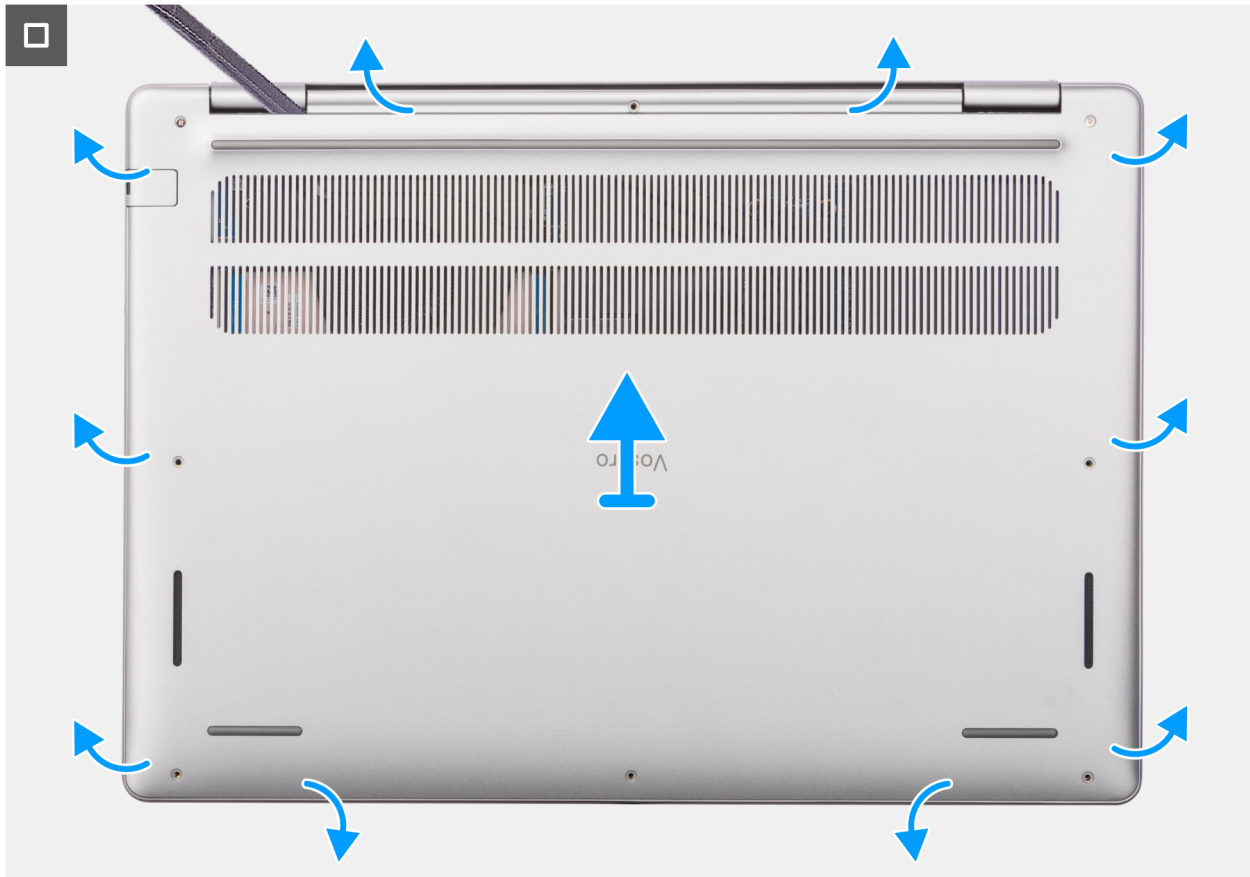

**Figure 16. Removing the base cover**

**Steps**

1. Remove the six (M2x5.5) screws and loosen the two captive screws that secure the base cover to the palm-rest and keyboard assembly.
2. Using a plastic scribe, pry open the base cover starting from the recesses, which are located in the U-shaped indents at the top edge of the base cover, near the hinges.
3. Pry open the top side of the base cover and continue working on the left and right sides to open the base cover.
4. Lift and remove the base cover off the palm-rest and keyboard assembly.

## Installing the base cover

**Prerequisites**

If you are replacing a component, remove the existing component before performing the installation procedure.

**About this task**

The following images indicate the location of the base cover and provide a visual representation of the installation procedure.

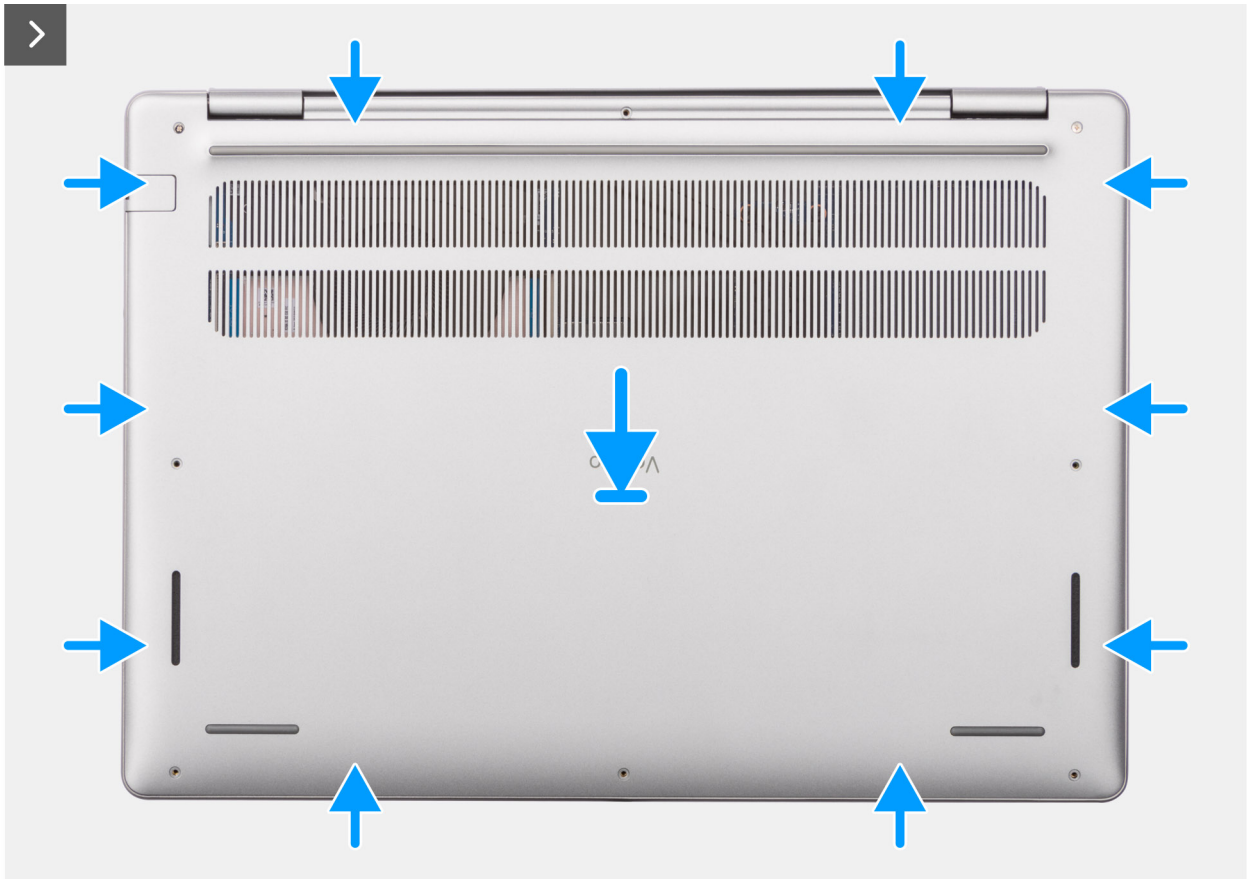

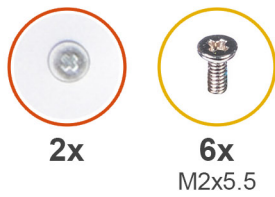

**Figure 17. Installing the base cover**

### Steps

1. Place the base cover on top of the palm-rest and keyboard assembly.
2. Align the screw holes on the base cover with the screw holes on the palm-rest and keyboard assembly, and snap the base cover latches into place.
3. Tighten the two captive screws and replace the six (M2x5.5) screws to secure the base cover to the palm-rest and keyboard assembly.

### Next steps

1. Follow the procedure in [After working inside your computer](#).



# Memory module

## Removing the memory module

### Prerequisites

1. Follow the procedure in [Before working inside your computer](#).
2. Remove the [base cover](#).

### About this task

The following images indicate the location of the memory module and provide a visual representation of the removal procedure.

 **NOTE:** Vostro 16 5640 supports a dual-channel RAM memory configuration.

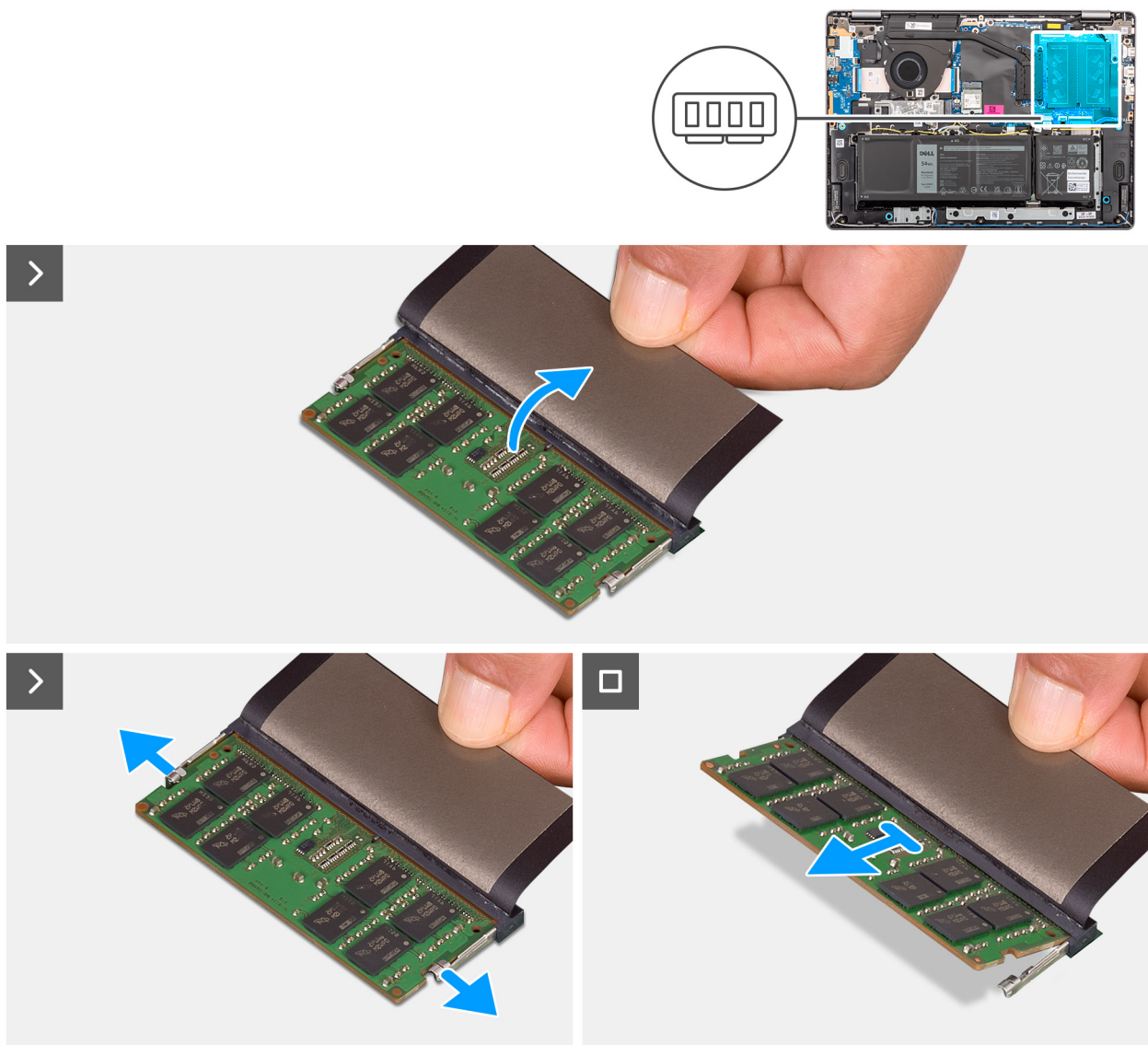

**Figure 18. Removing the memory module**

### Steps

1. Lift the Mylar to access the memory module.
2. Use your fingertips to pull the securing clips from both sides of the memory module until the memory module pops up.

- Slide the memory module at an angle and remove it from the memory-module slot (DIMM A DDR5 ONLY or DIMM B DDR5 ONLY) on the system board.

## Installing the memory module

### Prerequisites

If you are replacing a component, remove the existing component before performing the installation procedure.

### About this task

The following images indicate the location of the memory module and provide a visual representation of the installation procedure.

**NOTE:** Vostro 16 5640 supports a dual-channel RAM memory configuration.

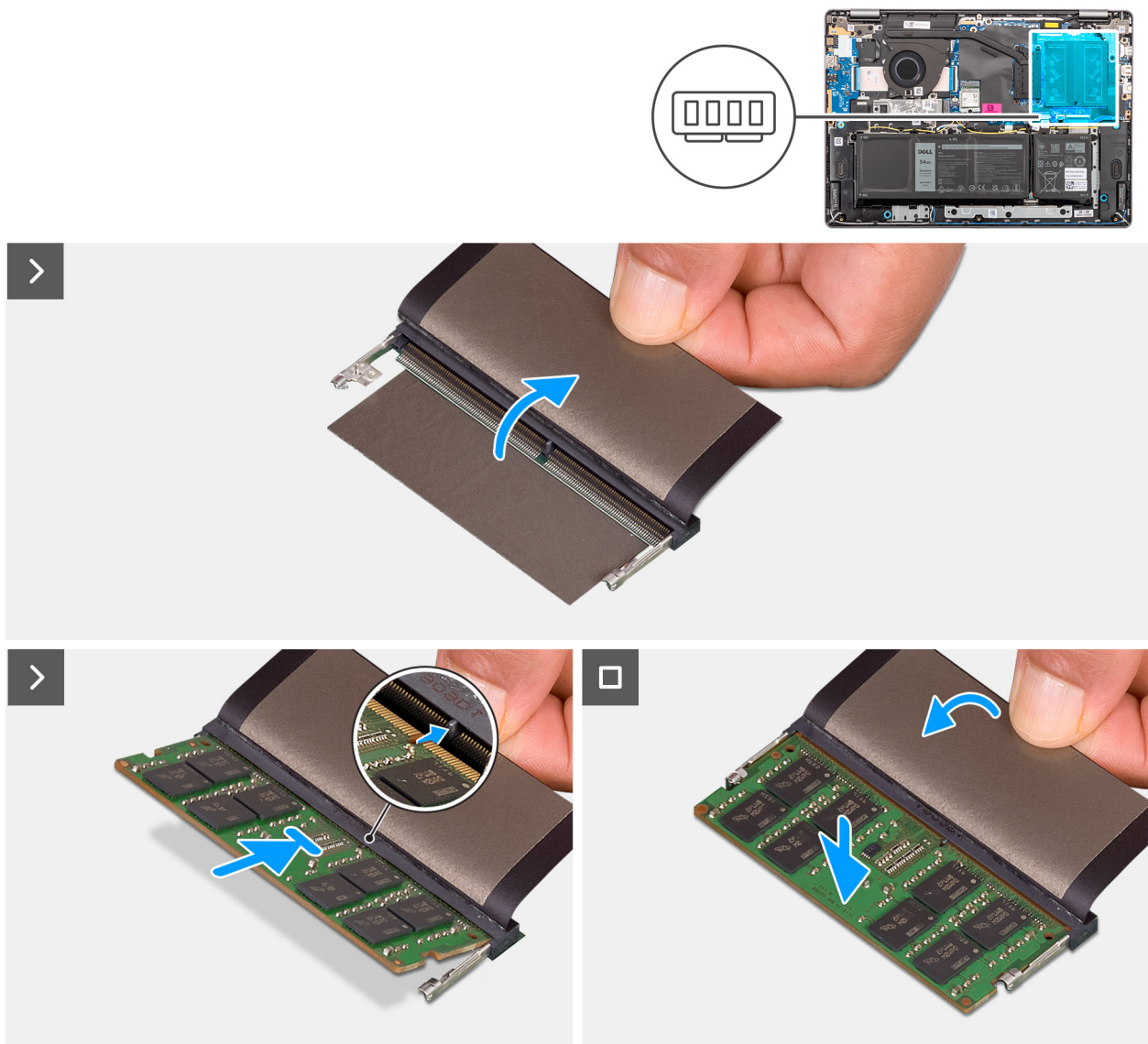

Figure 19. Installing the memory module

### Steps

- Lift the Mylar to access the memory-module slot.
- Align the notch on the memory module with the tab on the memory-module slot (DIMM A DDR5 ONLY or DIMM B DDR5 ONLY) on the system board.

- Slide the memory module firmly into the memory-module slot at an angle.
- Press down on the memory module to snap it into place on the system board. Ensure that the memory-module retention clips have locked the memory module into place.

**NOTE:** If you do not hear the click, remove the memory module and reinstall it.

### Next steps

- Install the [base cover](#).
- Follow the procedure in [After working inside your computer](#).

## M.2 solid state drive

### Removing the solid-state drive

#### Prerequisites

- Follow the procedure in [Before working inside your computer](#).
- Remove the [base cover](#).

#### About this task

**CAUTION:** Avoid touching the solid-state drive thermal pad, as it may reduce the thermal performance.

The following images indicate the location of the solid state drive and provide a visual representation of the removal procedure.

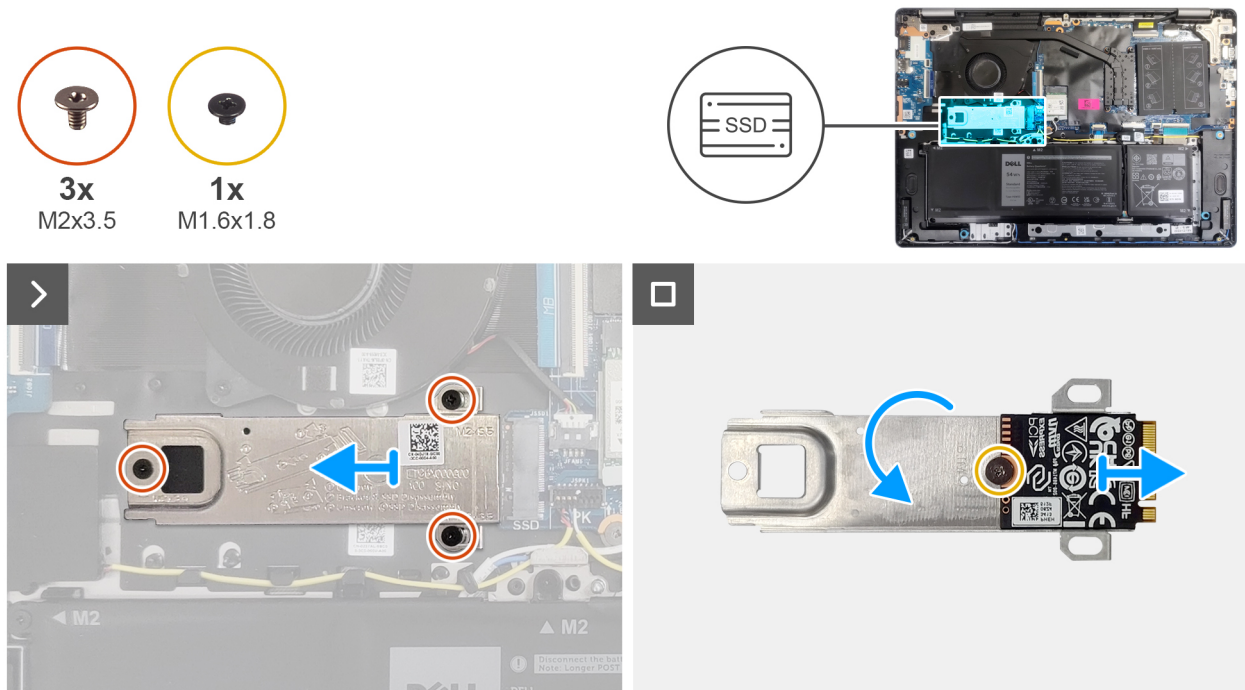

**Figure 20. Removing the solid-state drive**

#### Steps

- Remove the three screws (M2x3.5) that secure the solid-state drive to the system board.
- Slide and remove the solid-state drive thermal plate along with the solid-state drive from the M.2 card slot (SSD) on the system board.
- Reverse the thermal plate and remove the screw (M1.6x1.8) that secures the solid-state drive to the thermal plate.
- Remove the solid state drive from the thermal plate.

# Installing the solid-state drive

## Prerequisites

If you are replacing a component, remove the existing component before performing the installation procedure.

## About this task

**CAUTION:** Avoid touching the solid-state drive thermal pad, as it may reduce the thermal performance.

The following images indicate the location of the solid state drive and provide a visual representation of the installation procedure.

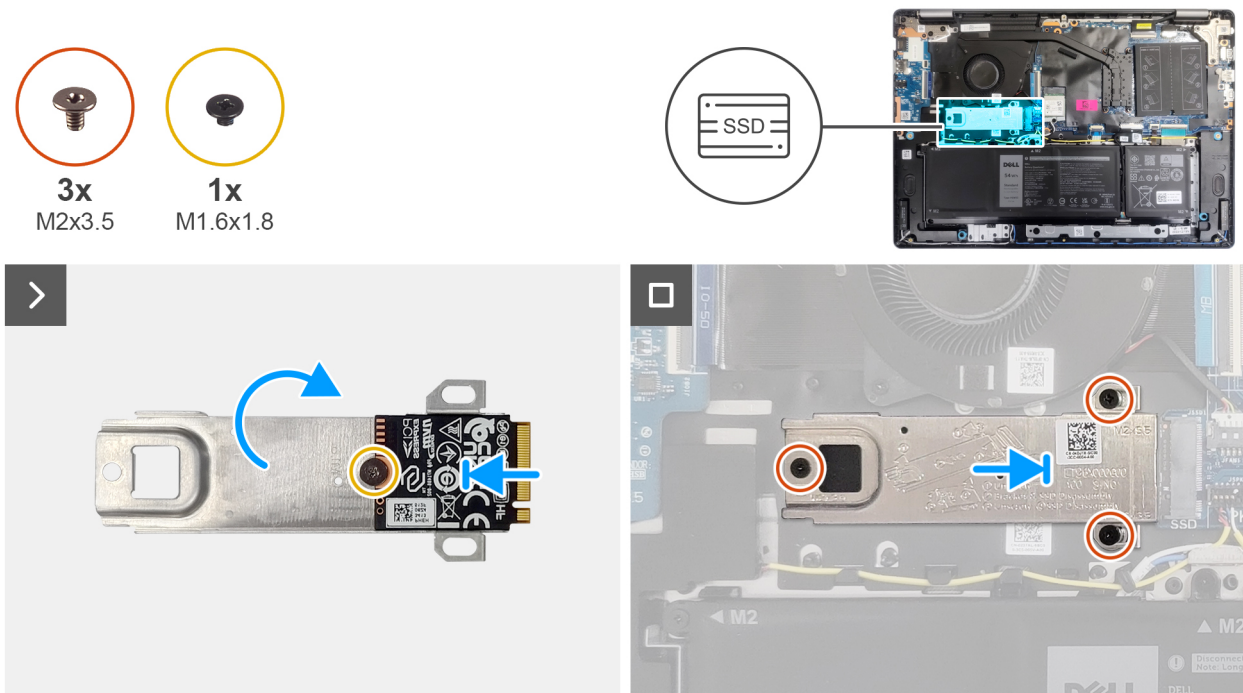

Figure 21. Installing the solid-state drive

## Steps

1. Align and place the solid-state drive on the thermal plate.
2. Replace the screw (M1.6x1.8) to secure the solid-state drive to the thermal plate.
3. Reverse the thermal plate along with the solid-state drive.
4. Align the notch on the solid-state drive with the tab on the M.2 card slot (SSD) on the system board.
5. Slide the solid-state drive in the M.2 card slot (SSD) on the system board.
6. Align the screw holes on the solid-state drive thermal plate with the screw holes on the system board.
7. Replace the three screws (M2x3.5) to secure the solid-state drive to the system board.

## Next steps

1. Install the [base cover](#).
2. Follow the procedure in [After working inside your computer](#).

# Wireless card

## Removing the wireless card

### Prerequisites

1. Follow the procedure in [Before working inside your computer](#).
2. Remove the [base cover](#).

### About this task

The following images indicate the location of the wireless card and provide a visual representation of the removal procedure.

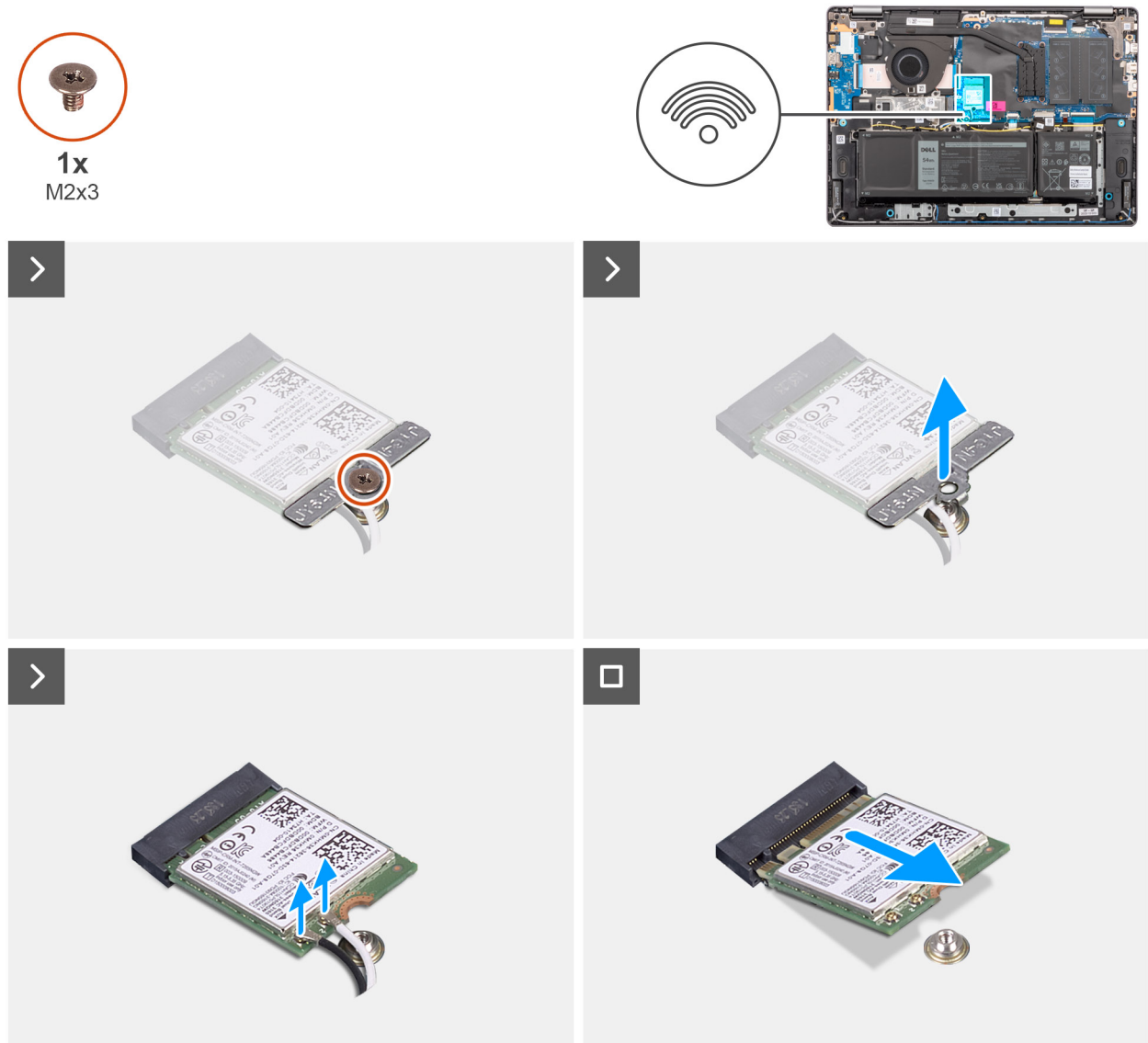

Figure 22. Removing the wireless card

### Steps

1. Remove the screw (M2x3.5) that secures the wireless-card bracket to the system board.
2. Lift the wireless-card bracket off the wireless card.
3. Disconnect the wireless-antenna cables from the connectors on the wireless card.
4. Slide and remove the wireless card from the wireless-card slot (WLAN) on the system board.

# Installing the wireless card

## Prerequisites

If you are replacing a component, remove the existing component before performing the installation procedure.

## About this task

The following images indicate the location of the wireless card and provide a visual representation of the installation procedure.

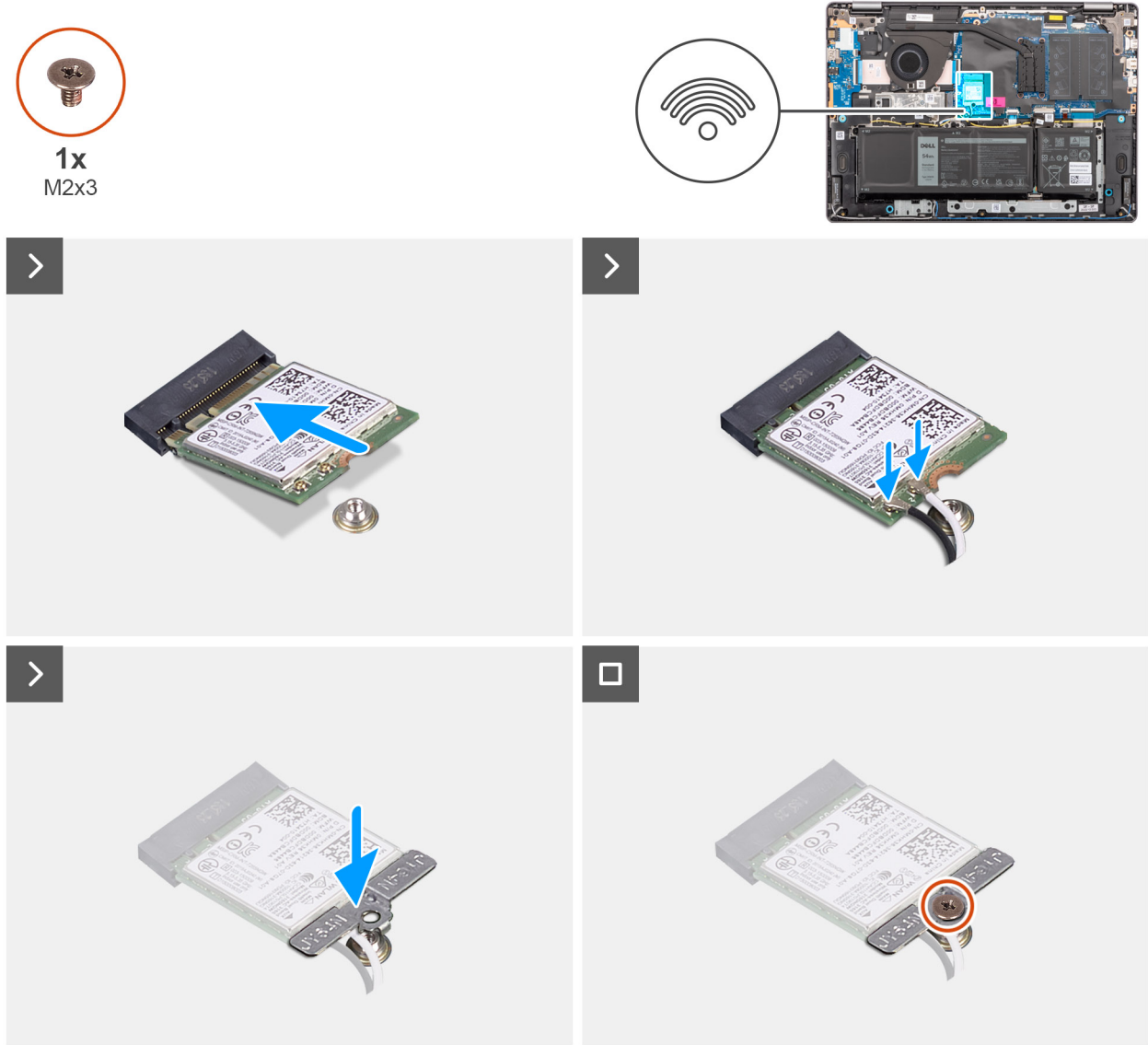

Figure 23. Installing the wireless card

## Steps

1. At an angle, slide the wireless card into the wireless-card slot (WLAN) on the system board.
2. Connect the wireless-antenna cables to the wireless card.

The following table provides the antenna-cable color scheme for the wireless card that is supported by your computer.

Table 30. Antenna-cable color scheme

Connector on the wireless card	Antenna-cable color	Silkscreen marking	
Main	White	MAIN	△ (white triangle)

**Table 30. Antenna-cable color scheme (continued)**

Connector on the wireless card	Antenna-cable color	Silkscreen marking	
Auxiliary	Black	AUX	▲ (black triangle)

3. Place the wireless-card bracket on the wireless card.
4. Align the screw hole on the wireless-card bracket with the screw hole on the system board.
5. Replace the screw (M2x3.5) to secure the wireless-card bracket and the wireless card to the system board.

**Next steps**

1. Install the [base cover](#).
2. Follow the procedure in [After working inside your computer](#).

## Speakers

### Removing the speakers

**Prerequisites**

1. Follow the procedure in [Before working inside your computer](#).
2. Remove the [base cover](#).

**About this task**

The following image indicates the location of the speakers and provides a visual representation of the removal procedure.

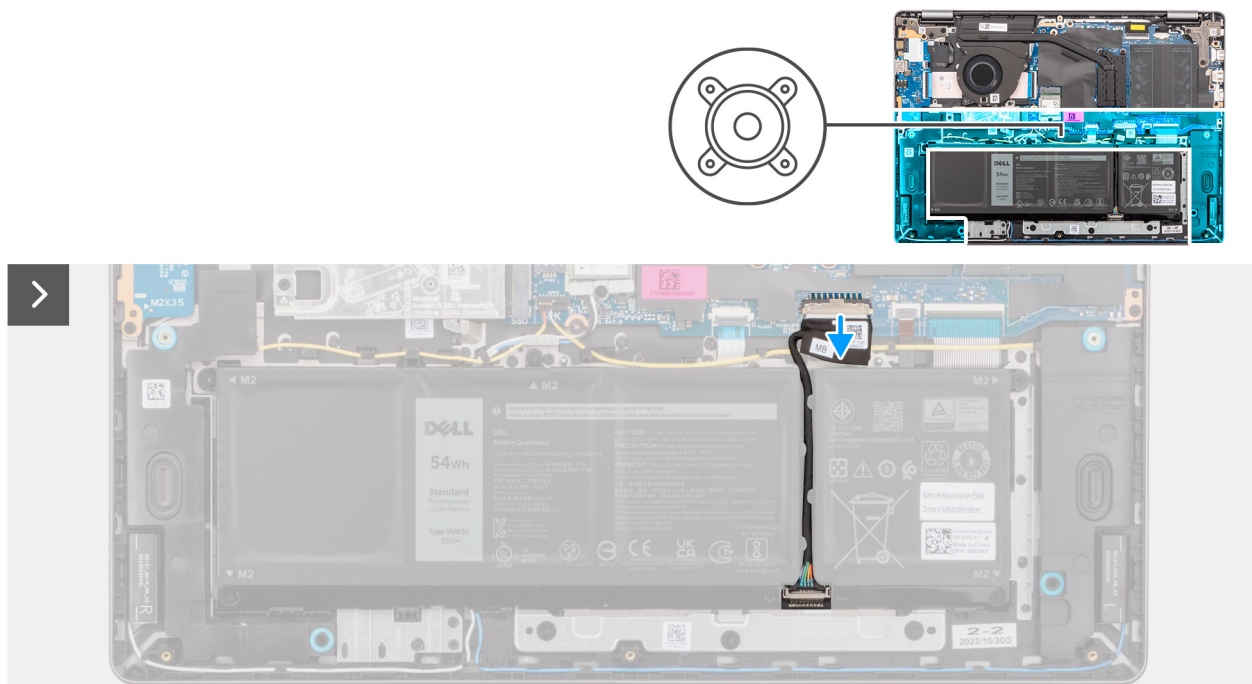

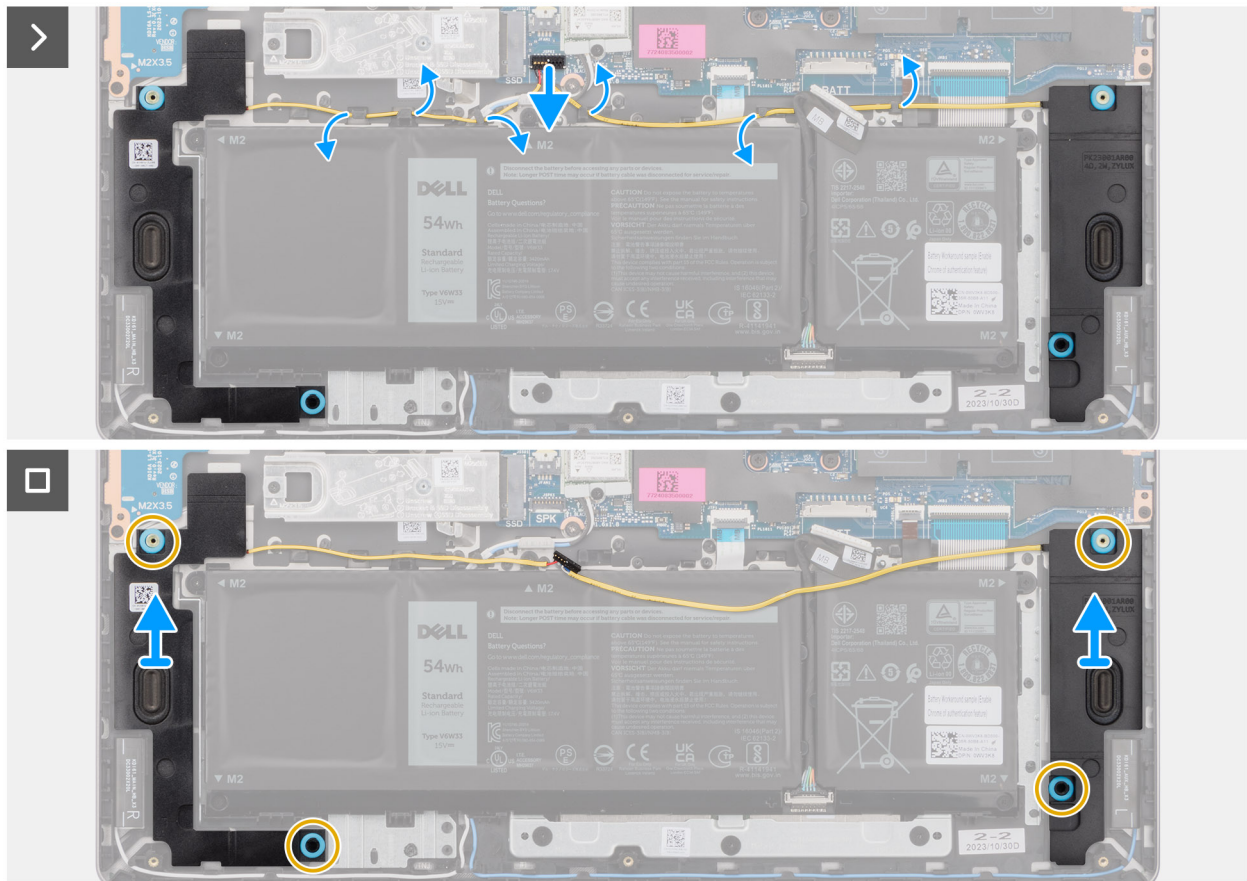

**Figure 24. Removing the speakers**

**Steps**

1. Disconnect the battery cable from its connector (BATT) on the system board.
2. Disconnect the speaker cable from its connector (SPK) on the system board.

**NOTE:** To disconnect the speaker cable from the system board, pry up the bottom side of the cable connector's head first and then pull it away from the connector (SPK) on the system board. **DO NOT** pull the cable downwards to disconnect the speaker cable from the system board.



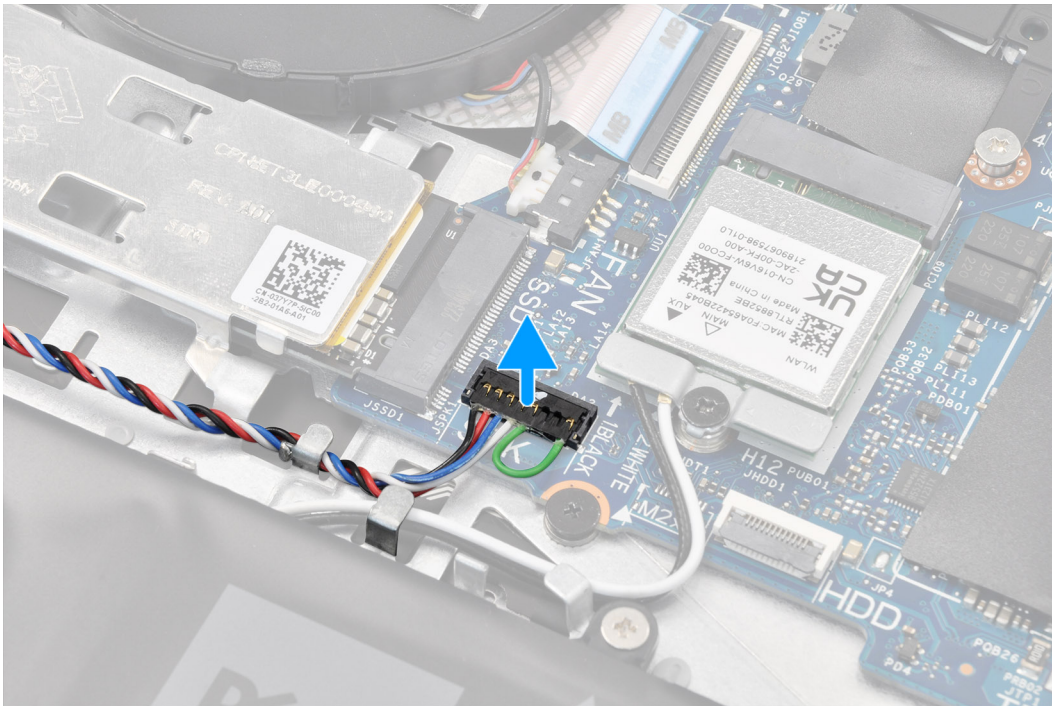

3. Remove the speaker cable from the routing guides on palm-rest and keyboard assembly.
4. Lift the speakers, along with the cable, off the palm-rest and keyboard assembly.

## Installing the speakers

### Prerequisites

If you are replacing a component, remove the existing component before performing the installation procedure.

### About this task

**NOTE:** If the rubber grommets are pushed out when removing the speakers, push them back in before replacing the speakers.

The following image indicates the location of the speakers and provides a visual representation of the installation procedure.

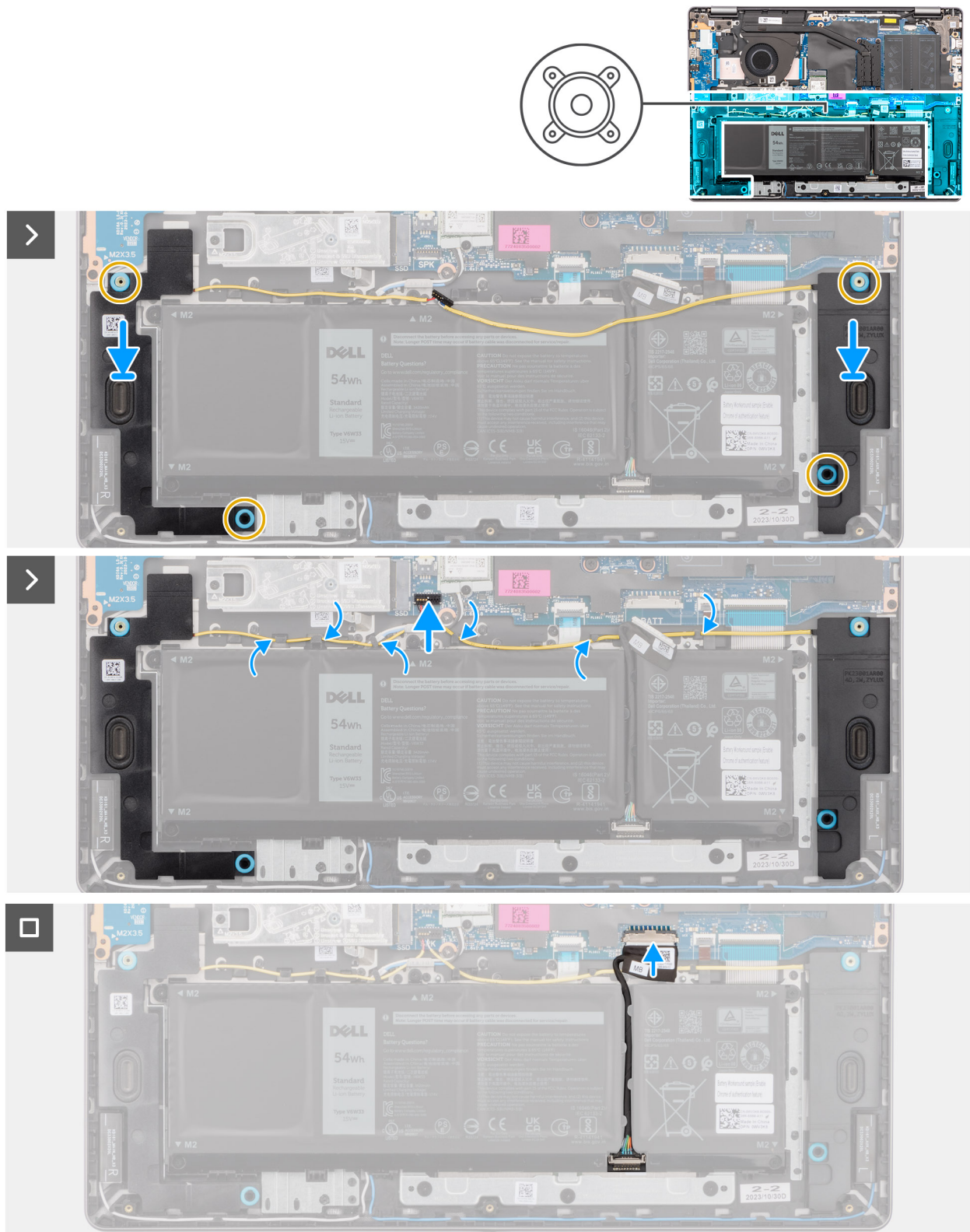

**Figure 25. Installing the speakers**

**Steps**

1. **NOTE:** If the rubber grommets are pushed out when removing the speakers, push them back in before replacing the speakers.

Using the alignment posts and rubber grommets, place the speakers in the slots on the palm-rest and keyboard assembly.

- NOTE:** Ensure that the alignment posts are threaded through the rubber grommets on the speakers. After placing speakers on the palm-rest and keyboard assembly, ensure that rubber grommets are seated into the slot and installed on the speakers properly.

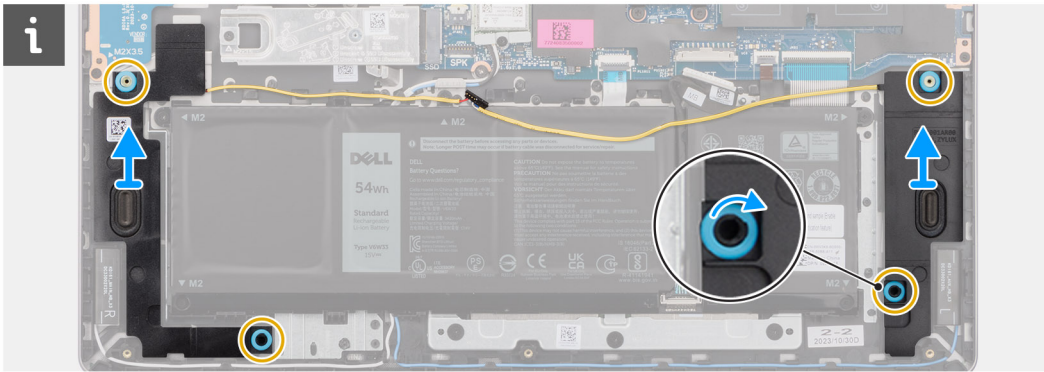

2. Route the speaker cable along the bottom side of the palm-rest and keyboard assembly, over the wireless-antenna cables. Then secure the speaker cable into the routing guides on the palm-rest and keyboard assembly.

- NOTE:** The speaker cable must be routed through the routing guides to avoid damaging the speaker cable when installing the base cover.

3. Connect the speaker cable to its connector (SPK) on the system board.
4. Connect the battery cable to its connector (BATT) on the system board.

#### Next steps

1. Install the [base cover](#).
2. Follow the procedure in [After working inside your computer](#).

## Fan

### Removing the fan

#### Prerequisites

1. Follow the procedure in [Before working inside your computer](#).
2. Remove the [base cover](#).

#### About this task

- CAUTION:** Avoid touching the fan blades while removing and installing the fan into the palm-rest and keyboard assembly. Failure to do so may result in damage to the fan blades or cause abnormal noise.

The following image indicates the location of the fan and provides a visual representation of the removal procedure.



2x  
M2x4

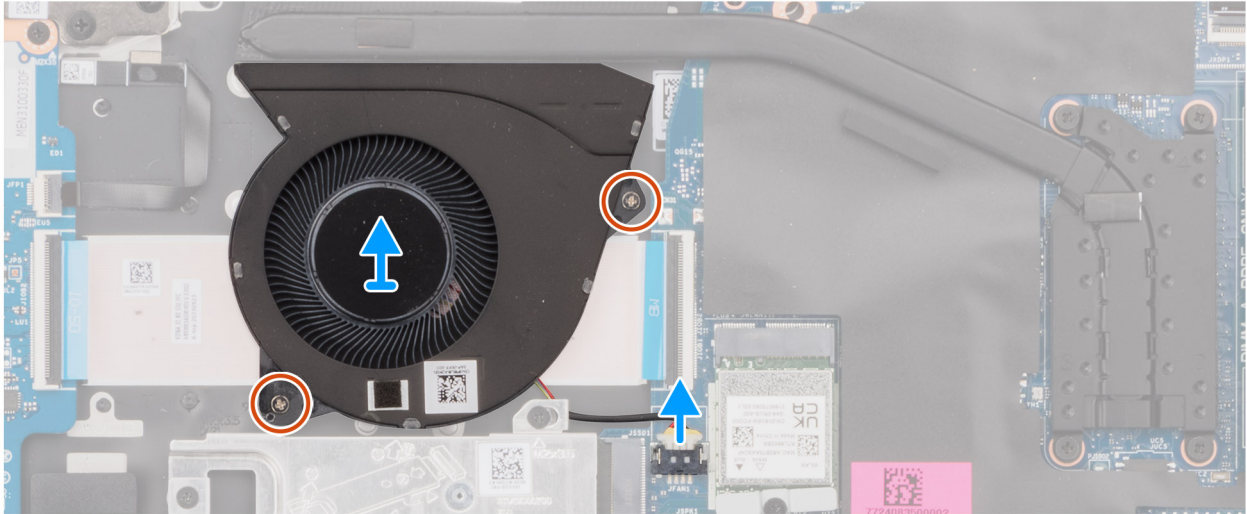
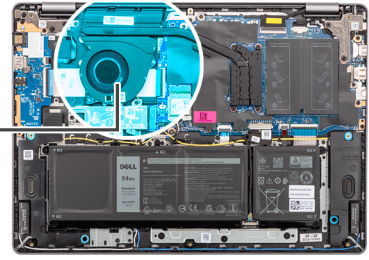
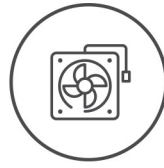

Figure 26. Removing the fan

### Steps

1. Disconnect the fan cable from its connector (FAN) on the system board.
2. Remove the two screws (M2x5.5) that secure the fan to the palm-rest and keyboard assembly.
3. Lift the fan, along with the fan cable, off the palm-rest and keyboard assembly.

## Installing the fan

### Prerequisites

If you are replacing a component, remove the existing component before performing the installation procedure.

### About this task

**CAUTION:** Avoid touching the fan blades while removing and installing the fan into the palm-rest and keyboard assembly. Failure to do so may result in damage to the fan blades or cause abnormal noise.

The following image indicates the location of the fan and provides a visual representation of the installation procedure.



**2x**  
M2x4

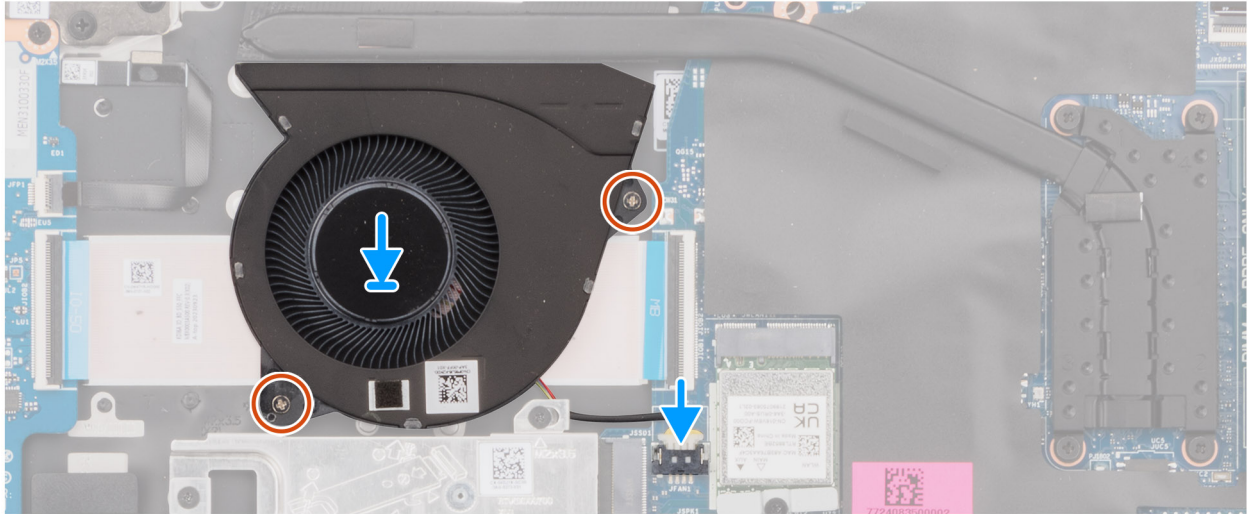
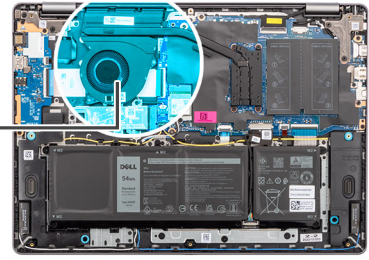
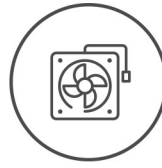

**Figure 27. Installing the fan**

#### Steps

1. Place and align the fan, along with fan cable, in the slot on the palm-rest and keyboard assembly.
2. Align the screw holes on the fan to the screw holes on the palm-rest and keyboard assembly.
3. Replace the two screws (M2x5.5) to secure the fan to the palm-rest and keyboard assembly.
4. Connect the fan cable to its connector (FAN) on the system board.

#### Next steps

1. Install the [base cover](#).
2. Follow the procedure in [After working inside your computer](#).

# Removing and installing Field Replaceable Units (FRUs)

The replaceable components in this chapter are Field Replaceable Units (FRUs).

**CAUTION:** The information in this section is intended for authorized service technicians only.

**CAUTION:** To avoid any potential damage to the component or loss of data, ensure that an authorized service technician replaces the Field Replaceable Units (FRUs).

**CAUTION:** Dell Technologies recommends that this set of repairs, if needed, to be conducted by trained technical repair specialists.

**CAUTION:** As a reminder, your warranty does not cover damages that may occur during FRU repairs that are not authorized by Dell Technologies.

**NOTE:** The images in this document may differ from your computer depending on the configuration you ordered.

## Battery

### Rechargeable Li-ion battery precautions

**CAUTION:**

- Exercise caution when handling rechargeable Li-ion batteries.
- Discharge the battery completely before removing it. Disconnect the AC power adapter from the computer and operate the computer solely on battery power—the battery is fully discharged when the computer no longer turns on when the power button is pressed.
- Do not crush, drop, mutilate, or penetrate the battery with foreign objects.
- Do not expose the battery to high temperatures, or disassemble battery packs and cells.
- Do not apply pressure to the surface of the battery.
- Do not bend the battery.
- Do not use tools of any kind to pry on or against the battery.
- Ensure any screws during the servicing of this product are not lost or misplaced, to prevent accidental puncture or damage to the battery and other computer components.
- If the battery gets stuck inside your computer as a result of swelling, do not try to release it as puncturing, bending, or crushing a rechargeable Li-ion battery can be dangerous. In such an instance, contact Dell technical support for assistance. See [www.dell.com/contactdell](http://www.dell.com/contactdell).
- Always purchase genuine batteries from [www.dell.com](http://www.dell.com) or authorized Dell partners and resellers.
- Swollen batteries should not be used and should be replaced and disposed properly. For guidelines on how to handle and replace swollen rechargeable Li-ion batteries, see [Handling swollen rechargeable Li-ion batteries](#).

### Removing the battery

**CAUTION:** The information in this section is intended for authorized service technicians only.

## Prerequisites

1. Follow the procedure in [Before working inside your computer](#).
2. Remove the [base cover](#).

## About this task

The following image indicates the location of the battery and provides a visual representation of the removal procedure.

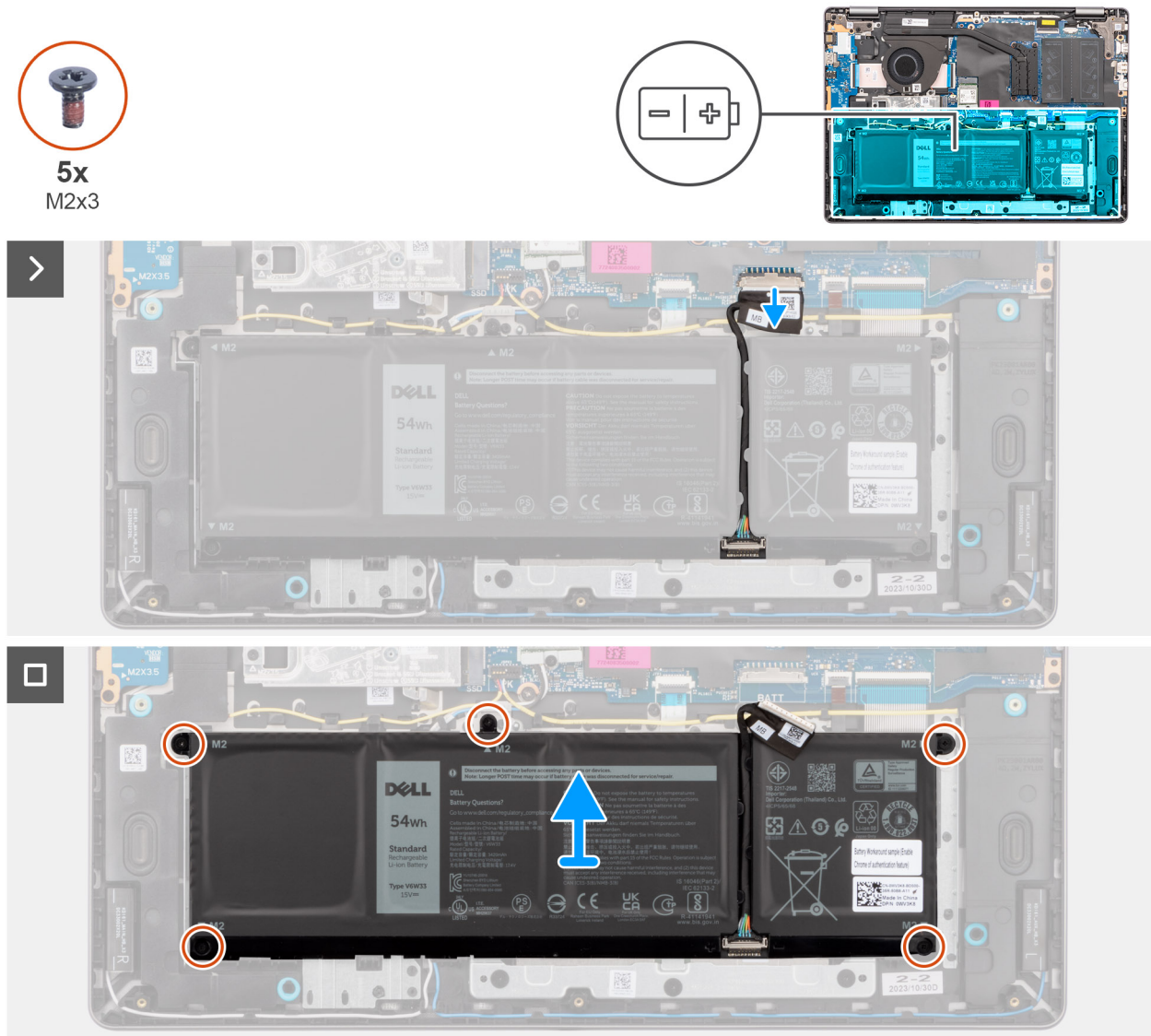

**Figure 28. Removing the battery**

## Steps

1. Disconnect the battery cable from its connector (BATT) on the system board.
2. Remove the five screws (M2x3.5) that secure the battery to the palm-rest and keyboard assembly.
3. Lift the battery, along with the battery cable, off the palm-rest and keyboard assembly.

## Disconnecting the battery cable

**CAUTION:** The information in this section is intended for authorized service technicians only.

## Prerequisites

1. Follow the procedure in [Before working inside your computer](#).
2. Remove the [base cover](#).
3. Remove the [battery](#).

## About this task

The following image indicates the location of the battery cable and provides a visual representation of the removal procedure.



**Figure 29. Disconnecting the battery cable**

## Steps

1. Unroute the battery cable from the routing guides on the battery. To disconnect the battery cable, first push the latch downward to release the connector, and then pull the connector upward to disconnect it from the battery.
2. Open the latch and disconnect the battery cable from the connector on the battery.

**NOTE:** To disconnect the battery cable, first push the latch downward to release the connector, and then pull the connector upward to disconnect it from the battery.



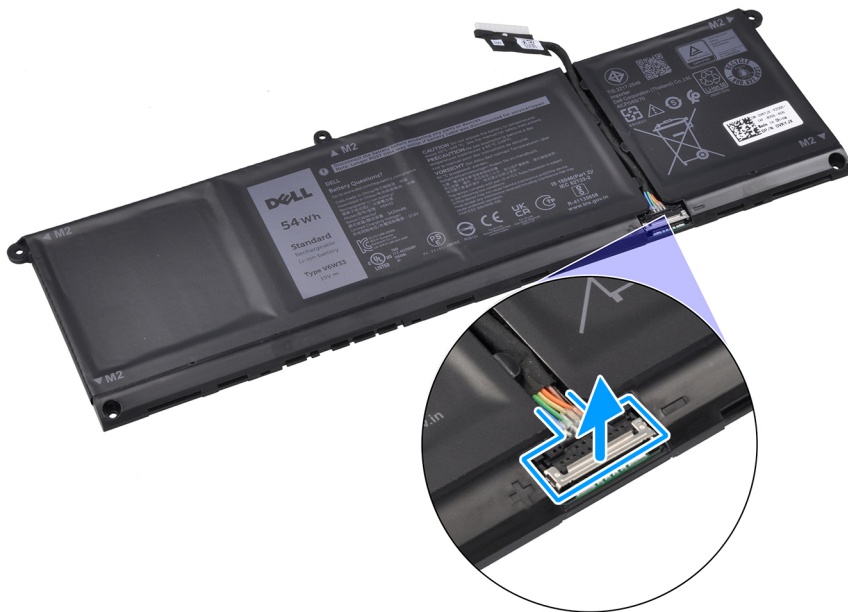
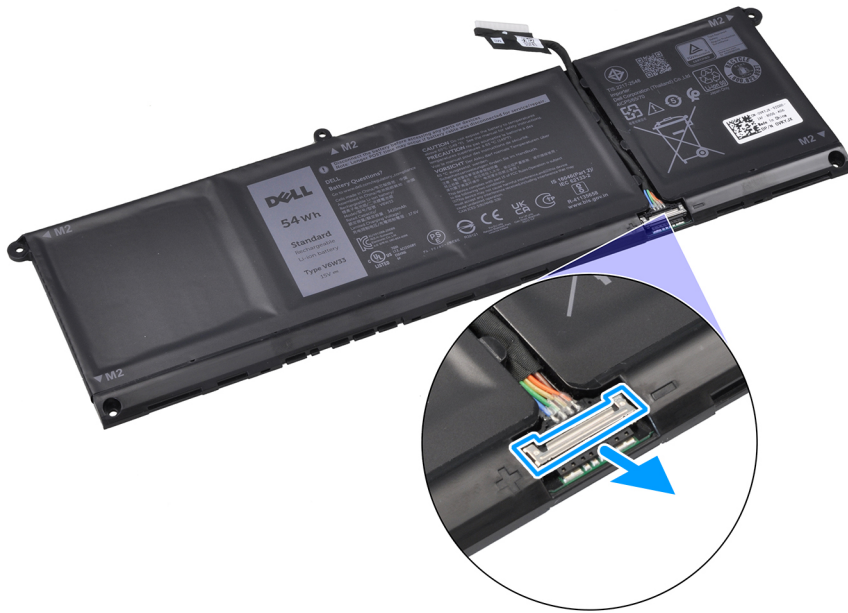

**CAUTION:** DO NOT pull the battery cable to disconnect it from the battery. This may damage the battery or the battery cable.

## Connecting the battery cable

**CAUTION:** The information in this section is intended for authorized service technicians only.

### Prerequisites

If you are replacing a component, remove the existing component before performing the installation procedure.

### About this task

The following image indicates the location of the battery cable and provides a visual representation of the installation procedure.

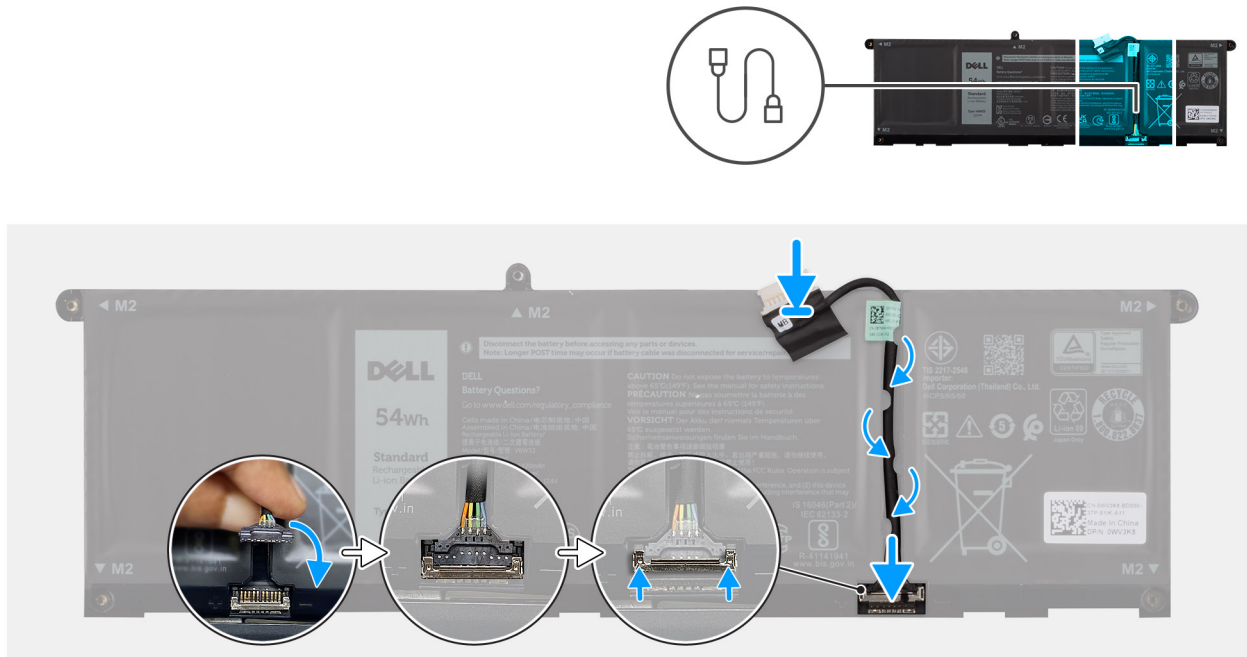

**Figure 30. Connecting the battery cable**

### Steps

1. Connect the battery cable to the connector on the battery and close the latch.
2. Route the battery cable through the routing guides on the battery.

### Next steps

1. Install the [battery](#).
2. Install the [base cover](#).
3. Follow the procedure in [After working inside your computer](#).

## Installing the battery

**CAUTION:** The information in this section is intended for authorized service technicians only.

### Prerequisites

If you are replacing a component, remove the existing component before performing the installation procedure.

### About this task

The following image indicates the location of the battery and provides a visual representation of the installation procedure.



5x  
M2x3

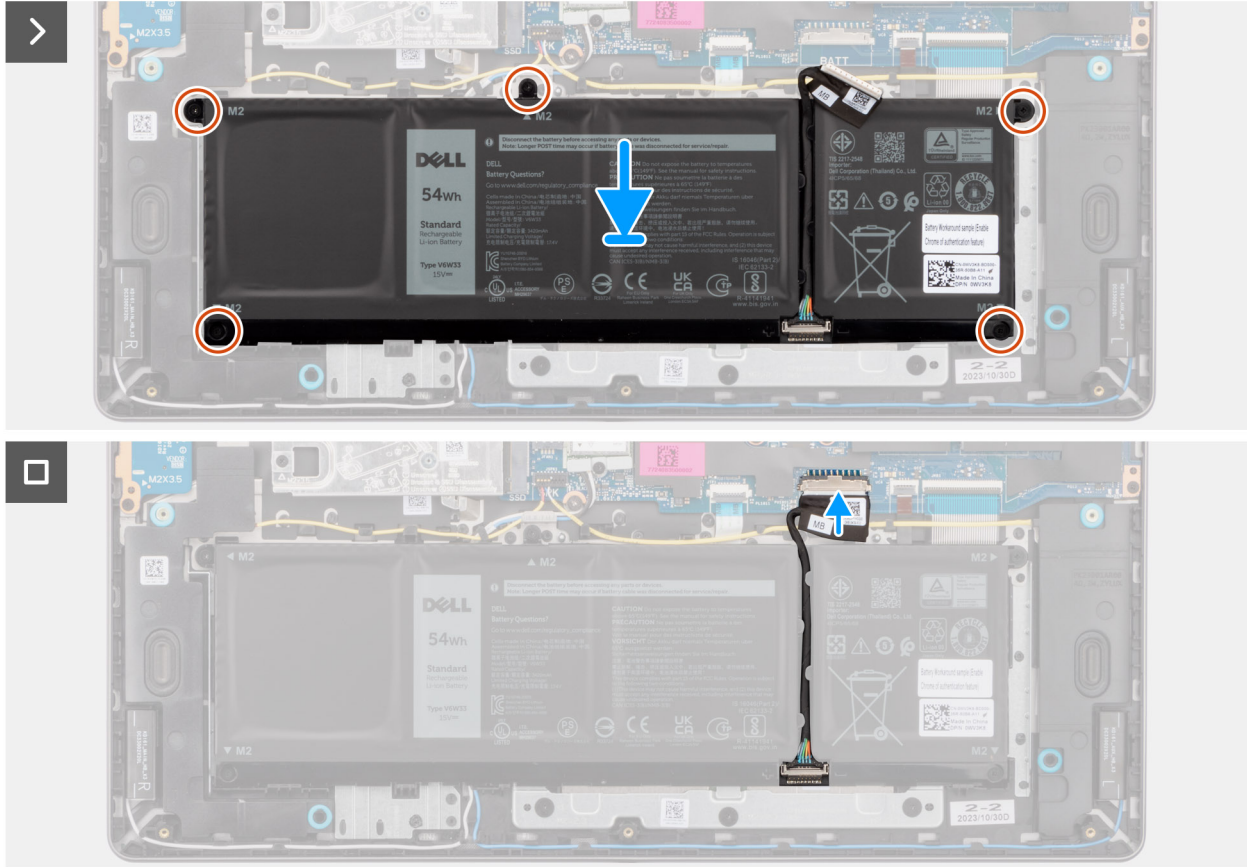
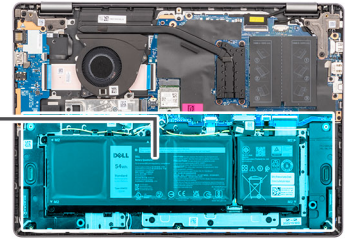
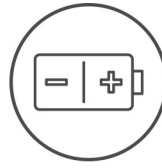
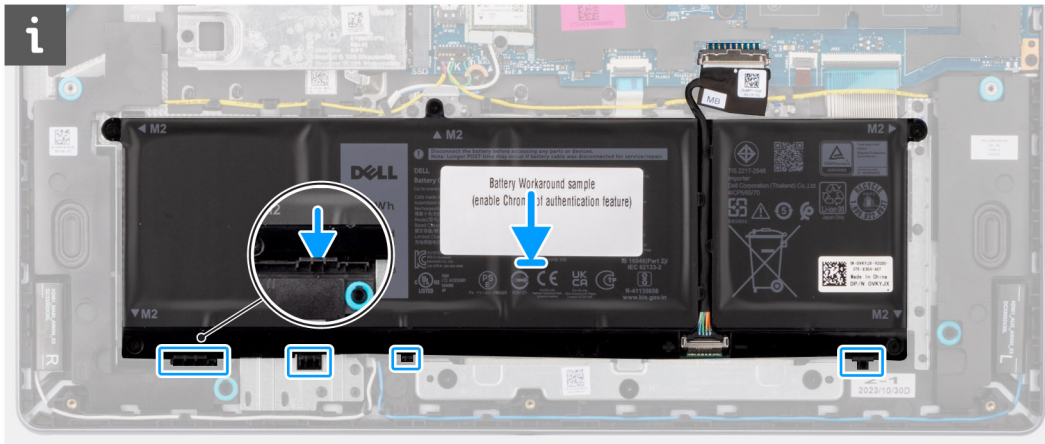

Figure 31. Installing the battery

### Steps

1. Place the battery, along with the battery cable, in the slot on the palm-rest and keyboard assembly.
2. Align the screw holes on the battery to the screw holes on the palm-rest and keyboard assembly.

**i** **NOTE:** While installing the battery, insert the cut-outs on the battery into the hooks on the palm-rest and keyboard assembly.



3. Replace the five screws (M2x3.5) to secure the battery to the palm-rest and keyboard assembly.
4. Connect the battery cable to its connector (BATT) on the system board.

#### Next steps

1. Install the [base cover](#).
2. Follow the procedure in [After working inside your computer](#).

## Heat sink

### Removing the heat sink

**CAUTION:** The information in this section is intended for authorized service technicians only.

#### Prerequisites

1. Follow the procedure in [Before working inside your computer](#).
2. Remove the [base cover](#).

#### About this task

**NOTE:** The heat sink may become hot during normal operation. Allow sufficient time for the heat sink to cool before you touch it.

**NOTE:** For maximum cooling of the processor, do not touch the heat transfer areas on the heat sink. The oils in your skin can reduce the heat transfer capability of the thermal grease.

**CAUTION:** Avoid touching the thermal grease and thermal pad, as it may reduce the thermal performance of the heat sink.

The following image indicates the location of the heat sink and provides a visual representation of the removal procedure.



4x

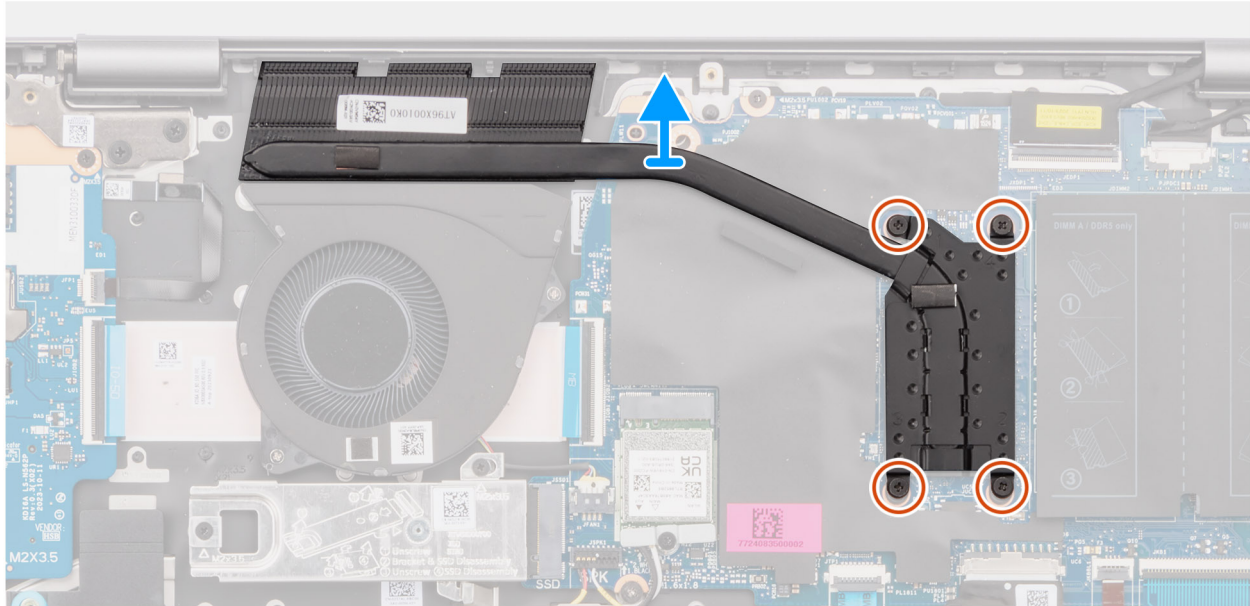
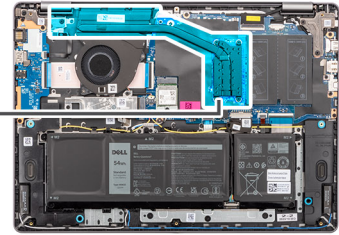

Figure 32. Removing the heat sink

### Steps

1. Loosen the four captive screws that secure the heat sink to the system board.

**NOTE:** Loosen the four captive screws in the reverse sequential order mentioned on the heat sink [4 > 3 > 2 > 1].

2. Lift the heat sink off the system board.

## Installing the heat sink

**CAUTION:** The information in this section is intended for authorized service technicians only.

### Prerequisites

If you are replacing a component, remove the existing component before performing the installation procedure.

### About this task

**NOTE:** If either the system board or the heat sink is replaced, use the thermal grease that is provided in the kit to ensure that thermal conductivity is achieved.

**CAUTION:** Avoid touching the thermal grease and thermal pad, as it may reduce the thermal performance of the heat sink.

The following image indicates the location of the heat sink and provides a visual representation of the installation procedure.



4x

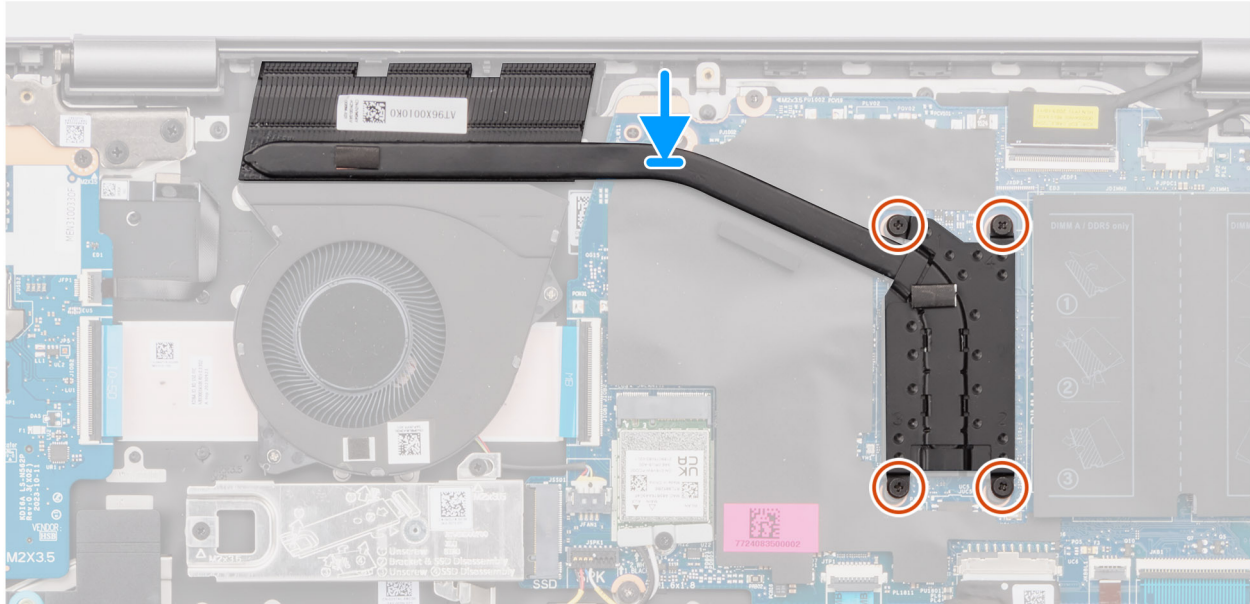
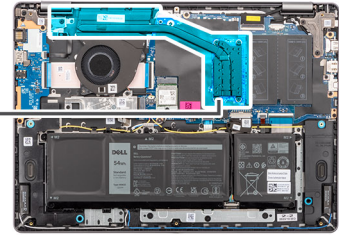

**Figure 33. Installing the heat sink**

### Steps

1. Place the heat sink in the slot on the system board.
2. Align the screw holes on the heat sink to the screw holes on the system board.
3. Tighten the four captive screws to secure the heat sink to the system board.

**NOTE:** Tighten the four captive screws in the sequential order mentioned on the heat sink [1 > 2 > 3 > 4].

### Next steps

1. Install the [base cover](#).
2. Follow the procedure in [After working inside your computer](#).

## Touchpad

### Removing the touchpad assembly

**CAUTION:** The information in this section is intended for authorized service technicians only.

### Prerequisites

1. Follow the procedure in [Before working inside your computer](#).
2. Remove the [base cover](#).
3. Remove the [battery](#).

### About this task

The following images indicate the location of the touchpad assembly and provide a visual representation of the removal procedure.

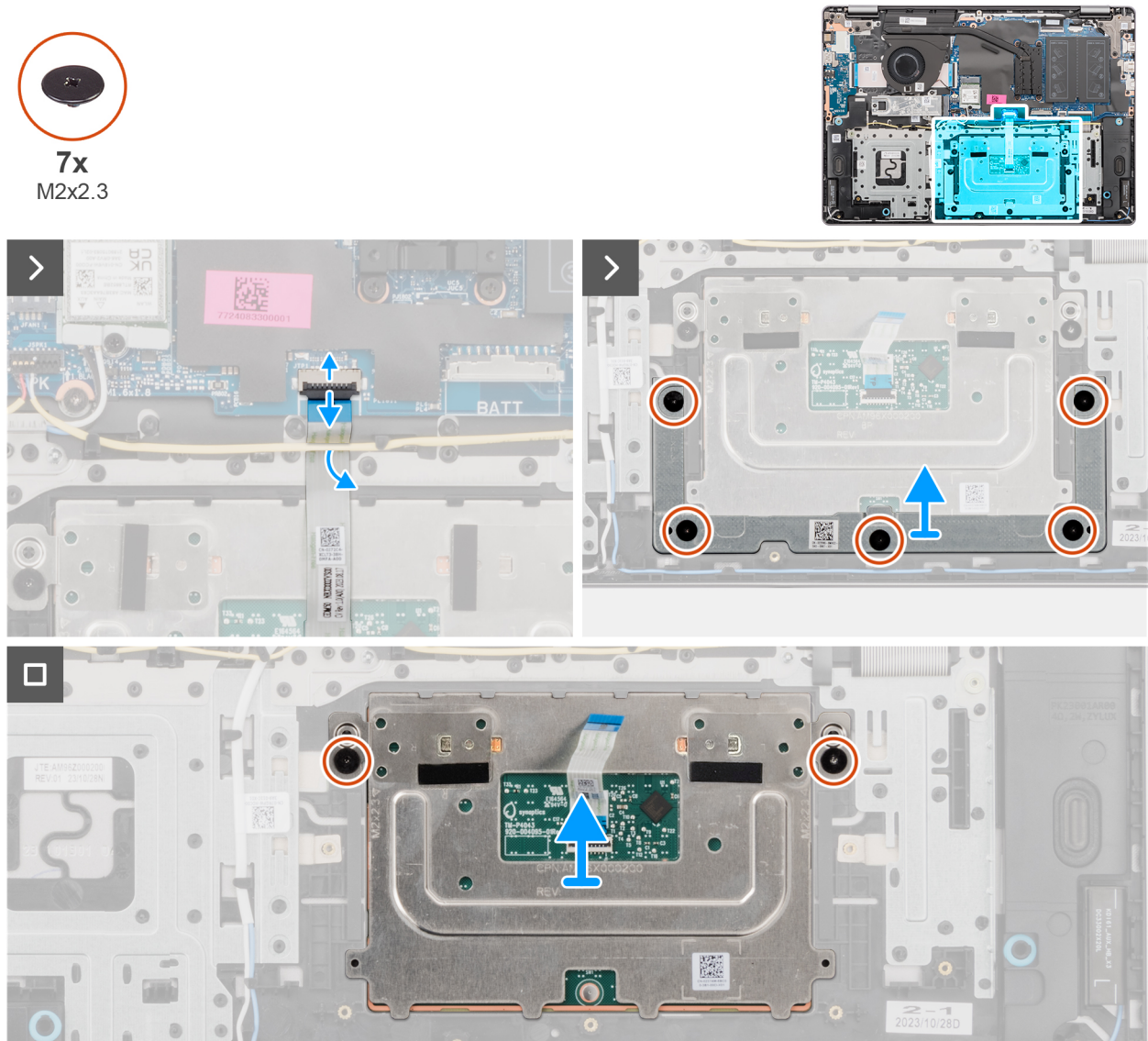

**Figure 34. Removing the touchpad assembly**

### Steps

1. Open the latch and disconnect the touchpad cable from its connector (TP) on the system board.
2. Remove the five screws (M2x2.3) that secure the touchpad bracket to the palm-rest and keyboard assembly.
3. Slide and lift the touchpad bracket off the touchpad assembly.
4. Remove the two screws (M2x2.3) that secure the touchpad module to the palm-rest and keyboard assembly.
5. Lift the touchpad module, along with the touchpad cable, off the palm-rest and keyboard assembly.

## Installing the touchpad assembly

**CAUTION:** The information in this section is intended for authorized service technicians only.

### Prerequisites

If you are replacing a component, remove the existing component before performing the installation procedure.

## About this task

**NOTE:** Ensure that the touchpad is aligned with the guides available on the palm-rest and keyboard assembly, and the gap on either sides of the touchpad is equal.

The following images indicate the location of the touchpad assembly and provide a visual representation of the installation procedure.

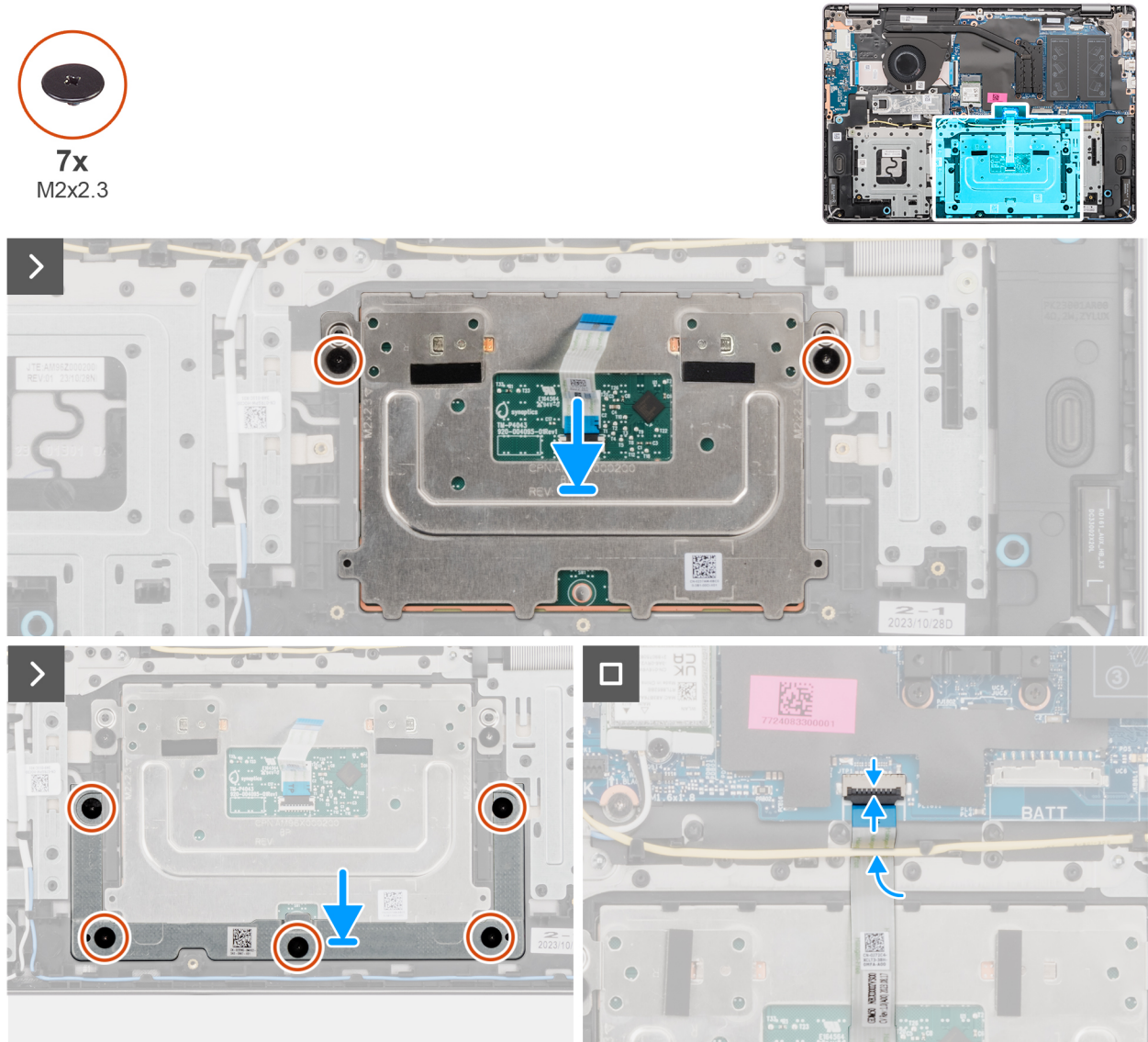

**Figure 35. Installing the touchpad assembly**

### Steps

1. Align and place the touchpad module, along with the touchpad cable, in the slot on the palm-rest and keyboard assembly.
2. Replace the two screws (M2x2.3) to secure the touchpad module to the palm-rest and keyboard assembly.
3. Place the touchpad bracket in the slot on the palm-rest and keyboard assembly.
4. Align the screw holes on the touchpad bracket to the screw holes on the palm-rest and keyboard assembly.
5. Replace the five screws (M2x2.3) to secure the touchpad bracket to the palm-rest and keyboard assembly.
6. Connect the touchpad cable to its connector (TP) on the system board and close the latch.

### Next steps

1. Install the [battery](#).
2. Install the [base cover](#).



3. Follow the procedure in [After working inside your computer](#).

## Display assembly

### Removing the display assembly

 **CAUTION:** The information in this section is intended for authorized service technicians only.

 **CAUTION:** The maximum operating angle for the display-panel hinge is 135 degrees.

#### Prerequisites

1. Follow the procedure in [Before working inside your computer](#).
2. Remove the [base cover](#).

#### About this task

The following images indicate the location of the display assembly and provide a visual representation of the removal procedure.



**5x**  
M2.5x5

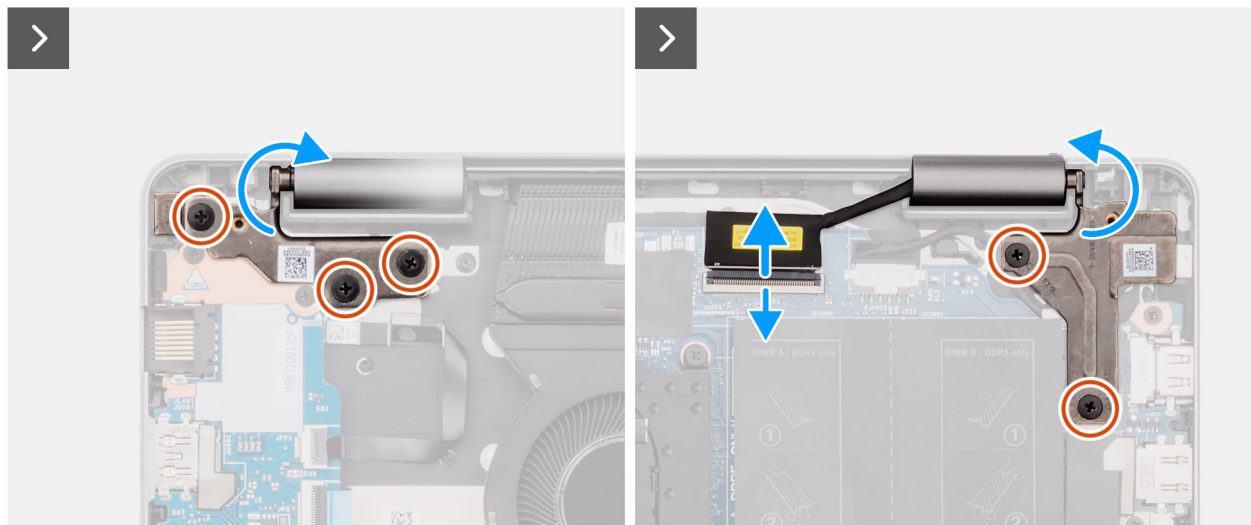
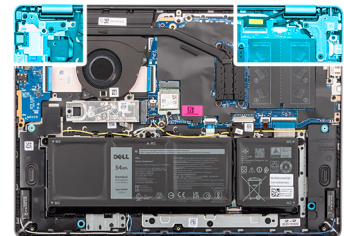

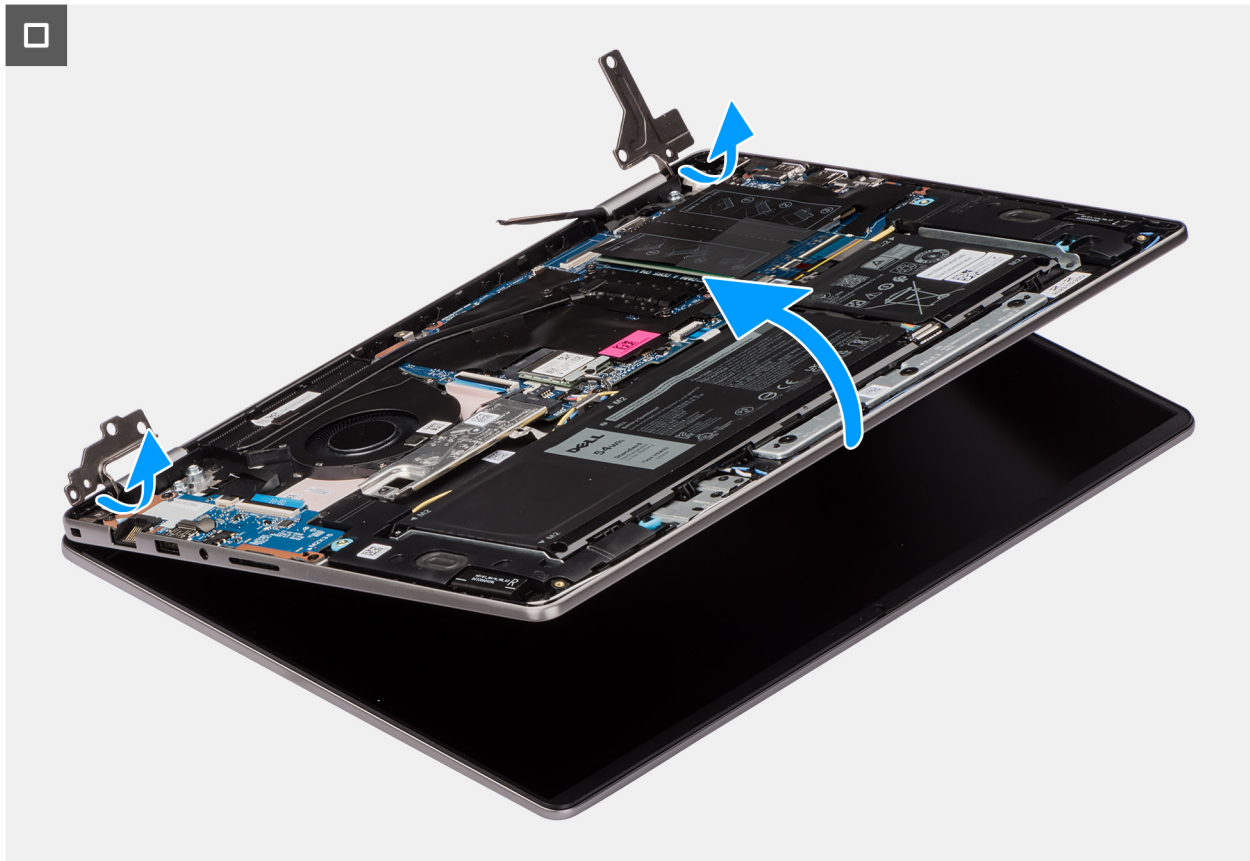

**Figure 36. Removing the display assembly**

### Steps

1. Remove the three screws (M2.5x5) from the left hinge and two screws (M2.5x5) from the right hinge that secures the display assembly to the palm-rest and keyboard assembly.
2. Disconnect the display cable from its connector (eDP) on the system board.
3. Unroute the display cable from the routing channel on the palm-rest and keyboard assembly.
4. Open the hinges to a 90-degree angle and place the computer on the edge of a flat surface.
5. Lift the palm-rest and keyboard assembly at an angle to free it from the hinges and remove it from the display assembly.

**i NOTE:** The display assembly is a Hinge-Up Design (HUD) assembly and cannot be further disassembled once it is removed from the bottom chassis. If any components in the display assembly malfunction and requires replacement, the entire display assembly has to be replaced.

**i NOTE:** The power-adaptor port is secured in place by the right hinge. There is no screw, tape, or adhesive securing the power-adaptor port to the palm-rest. As a result, technicians should take note of whether the power-adaptor port has fallen out of the system during subsequent removal procedures.

## Installing the display assembly

**⚠ CAUTION:** The information in this section is intended for authorized service technicians only.

**⚠ CAUTION:** The maximum operating angle for the display-panel hinge is 135 degrees.

### Prerequisites

If you are replacing a component, remove the existing component before performing the installation procedure.

### About this task

**NOTE:** Ensure that the display hinges are opened to the maximum before replacing the display assembly on the palm-rest and keyboard assembly.

The following images indicate the location of the display assembly and provide a visual representation of the installation procedure.



**5x**  
M2.5x5

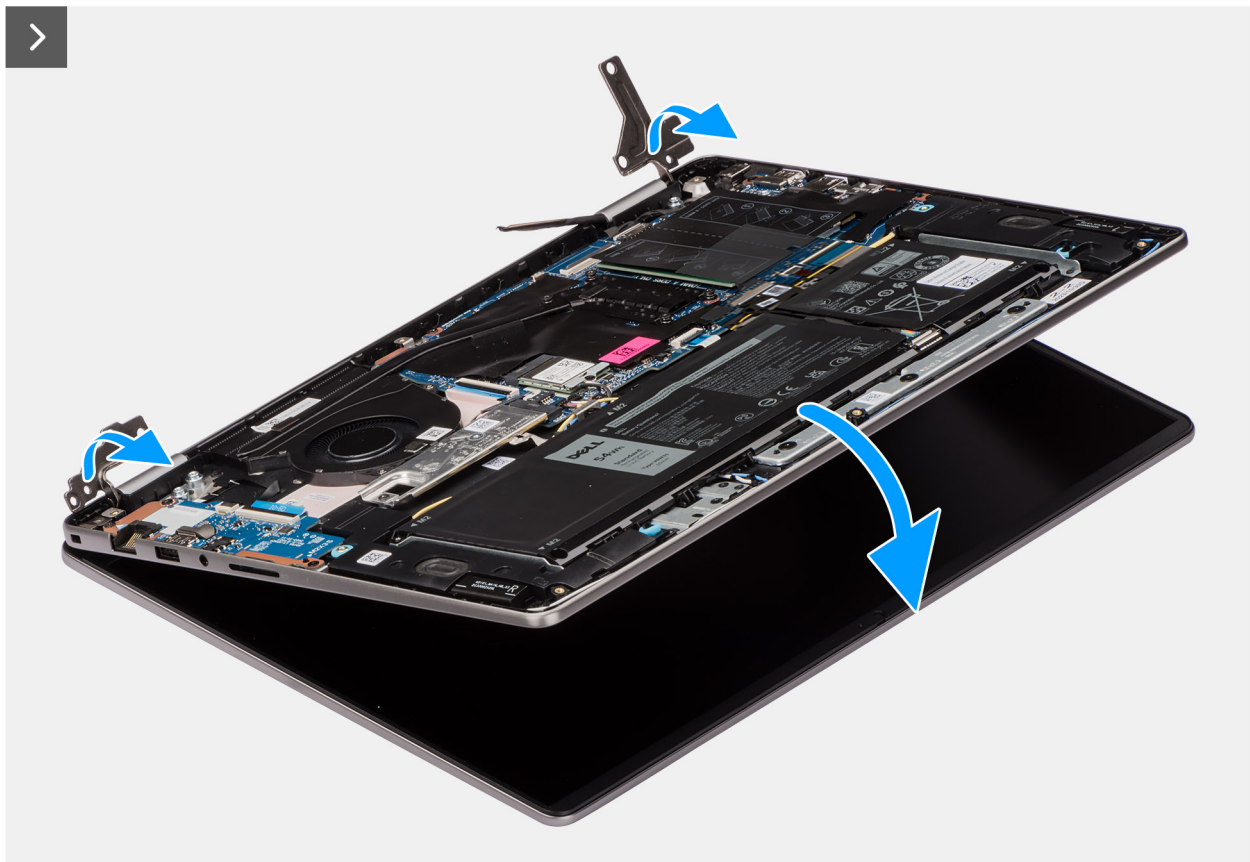
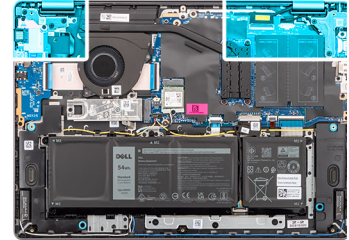

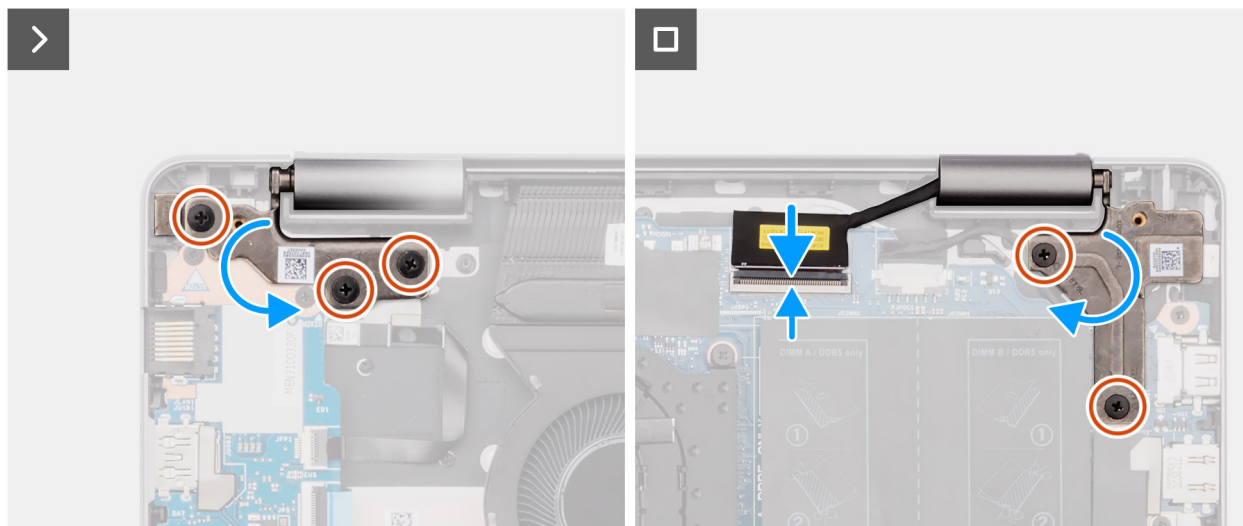

**Figure 37. Installing the display assembly**

### Steps

1. Place the display assembly on a clean and flat surface.
2. Slide the palm-rest and keyboard assembly at an angle and place the palm-rest and keyboard assembly on the display assembly.
  - i** **NOTE:** The power-adaptor port is secured in place by the right hinge. There is no screw, tape, or adhesives securing the power-adaptor port to the palm-rest. As a result, technicians should take note of whether the power-adaptor port has fallen out of the system during subsequent removal procedures.
3. Gently press down on the hinges to align the screw holes on the hinges with the screw holes on the palm-rest and keyboard assembly.
4. Connect the display cable to its connector (eDP) on the system board.
5. Replace the three screws (M2.5x5) on the left hinge and two screws (M2.5x5) on the right hinge that secures the display assembly to the palm-rest and keyboard assembly.

### Next steps

1. Install the [base cover](#).
2. Follow the procedure in [After working inside your computer](#).

## I/O-board cable

### Removing the I/O-board cable

**⚠ CAUTION:** The information in this section is intended for authorized service technicians only.

#### Prerequisites

1. Follow the procedure in [Before working inside your computer](#).
2. Remove the [base cover](#).
3. Remove the [fan](#).

#### About this task

The following image indicates the location of the I/O-board cable and provides a visual representation of the removal procedure.

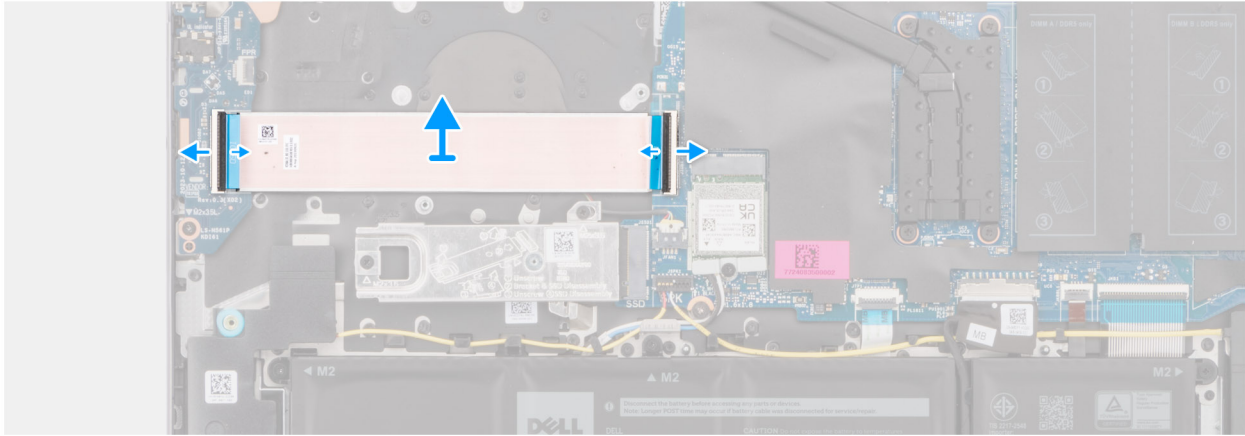
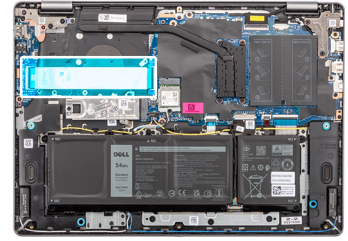

**Figure 38. Removing the I/O-board cable**

### Steps

1. Open the latch and disconnect the I/O-board cable from its connector (IO) on the system board.
2. Open the latch and disconnect the I/O-board cable from its connector on the I/O board.
3. Remove the I/O-board cable from the palm-rest and keyboard assembly.

## Installing the I/O-board cable

**CAUTION:** The information in this section is intended for authorized service technicians only.

### Prerequisites

If you are replacing a component, remove the existing component before performing the installation procedure.

### About this task

The following image indicates the location of the I/O-board cable and provides a visual representation of the installation procedure.

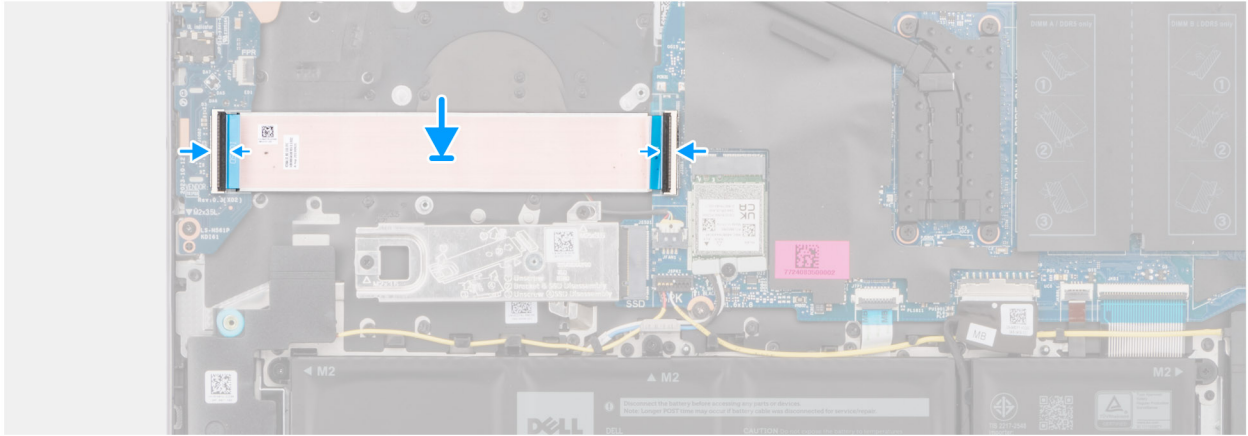
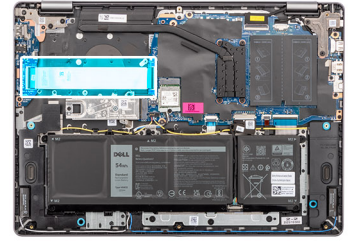

**Figure 39. Installing the I/O-board cable**

### Steps

1. Place the I/O-board cable on the palm-rest and keyboard assembly.
2. Connect the I/O-board cable to its connector on the I/O board and close the latch.
3. Connect the I/O-board cable to its connector (IO) on the system board and close the latch.

### Next steps

1. Install the [fan](#).
2. Install the [base cover](#).
3. Follow the procedure in [After working inside your computer](#).

## I/O board

### Removing the I/O board

 **CAUTION:** The information in this section is intended for authorized service technicians only.

### Prerequisites

1. Follow the procedure in [Before working inside your computer](#).
2. Remove the [base cover](#).

### About this task

The following images indicate the location of the I/O board and provide a visual representation of the removal procedure.

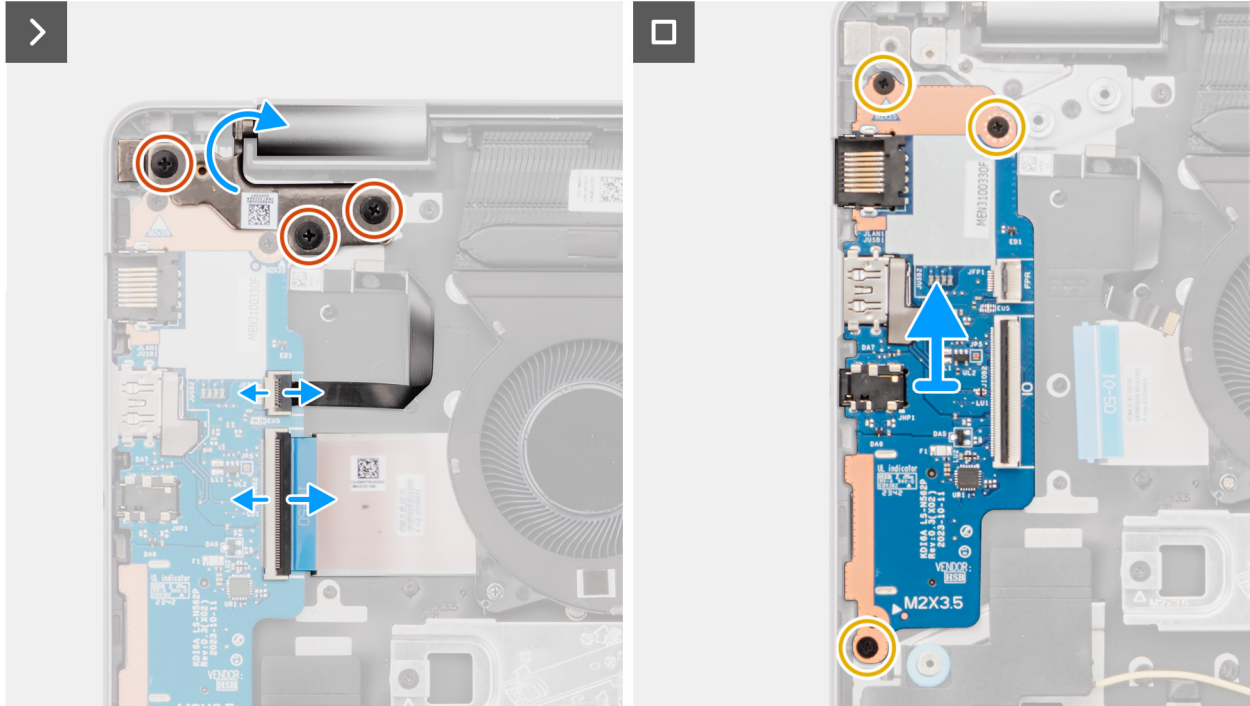
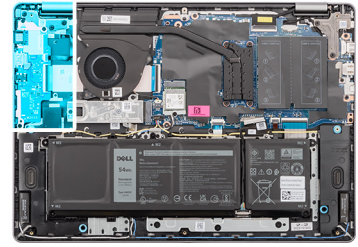

**Figure 40. Removing the I/O board**

### Steps

1. Remove the three screws (M2.5x5) that secure the left hinge to the palm-rest and keyboard assembly.
2. Open the left hinge to a 90-degree angle to access the I/O board.
3. Open the latch and disconnect the I/O board cable from its connector on the I/O board.
4. Open the latch and disconnect the fingerprint reader cable from the I/O board.

**NOTE:** This step applies only to computers shipped with a fingerprint reader installed.

5. Remove the three screws (M2x3.5) that secure the I/O board to the palm-rest and keyboard assembly.
6. Carefully slide and remove the I/O board at angle, from the palm-rest and keyboard assembly.

## Installing the I/O board

**CAUTION:** The information in this section is intended for authorized service technicians only.

### Prerequisites

If you are replacing a component, remove the existing component before performing the installation procedure.

### About this task

The following images indicate the location of the I/O board and provide a visual representation of the installation procedure.

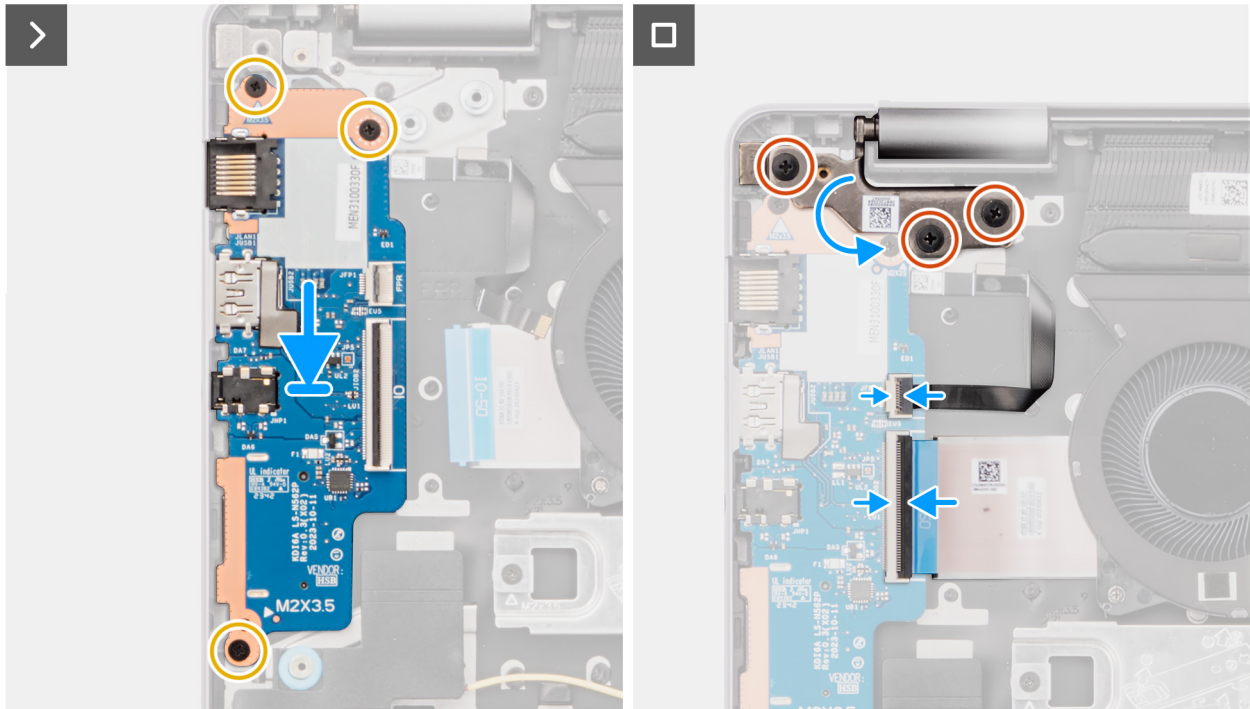
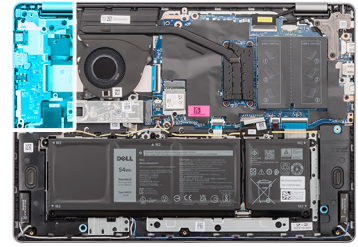
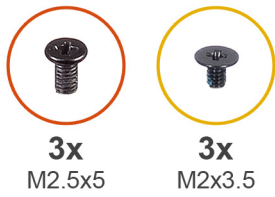

**Figure 41. Installing the I/O board**

### Steps

1. Align the ports on the I/O board to the port openings on the palm-rest and keyboard assembly.
2. Carefully slide and place the I/O board at an angle, on the palm-rest and keyboard assembly.
3. Align the screw holes on the I/O board to the screw holes on the palm-rest and keyboard assembly.
4. Replace the three screws (M2x3.5) to secure the I/O board to the palm-rest and keyboard assembly.
5. Connect the fingerprint reader cable to the connector on the I/O board and close the latch.

**NOTE:** This step applies only to computers shipped with a fingerprint reader installed.

6. Connect the I/O board cable to the connector on the I/O board and close the latch.
7. Close the left display hinge downwards to align the screw holes of the left hinge to the screw holes on the palm-rest and keyboard assembly.
8. Replace the three (M2.5x5) screws that secure the left hinge to the palm-rest and keyboard assembly.

### Next steps

1. Install the [base cover](#).
2. Follow the procedure in [After working inside your computer](#).



# Power button

## Removing the power button

**CAUTION:** The information in this section is intended for authorized service technicians only.

### Prerequisites

1. Follow the procedure in [Before working inside your computer](#).
2. Remove the [base cover](#).
3. Remove the [I/O board](#).

### About this task

The following image indicates the location of the power button and provides a visual representation of the removal procedure.

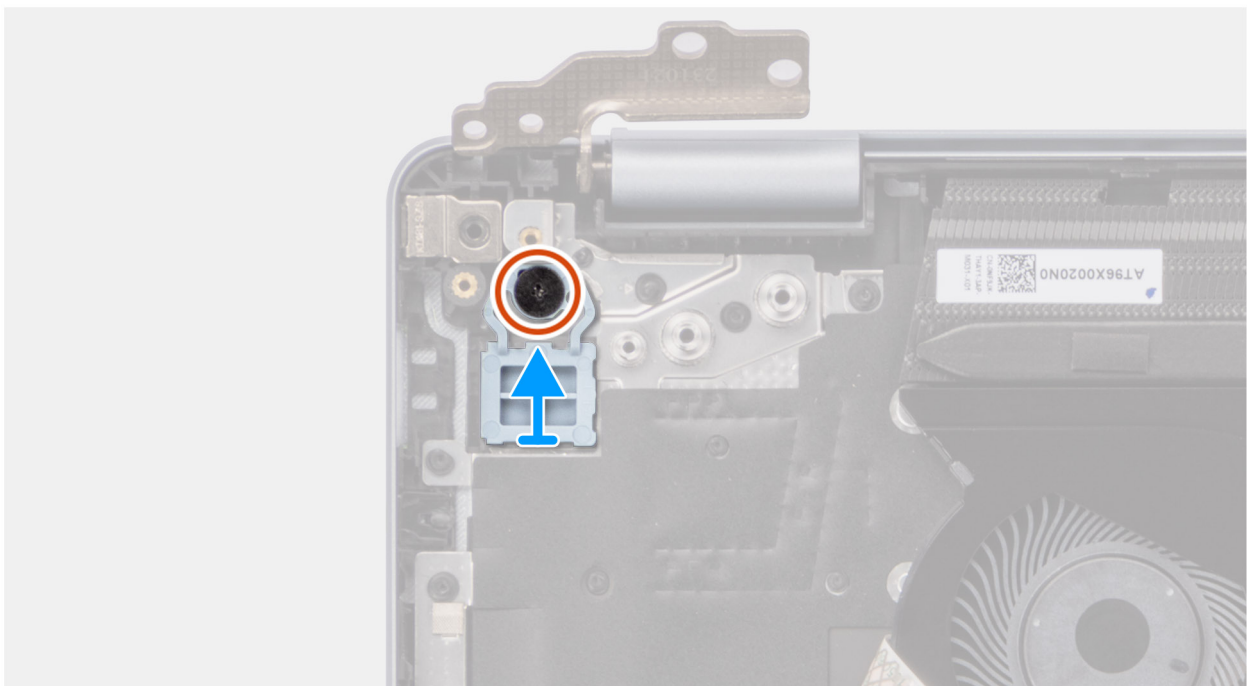
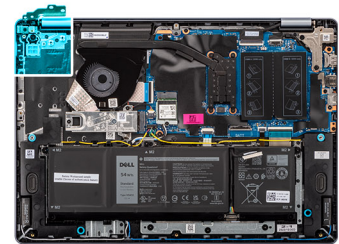

Figure 42. Removing the power button

### Steps

1. Remove the screw (M2x2.3) that secures the power button to the palm-rest and keyboard assembly.
2. Lift the power button off the palm-rest and keyboard assembly.

## Installing the power button

**CAUTION:** The information in this section is intended for authorized service technicians only.

### Prerequisites

If you are replacing a component, remove the existing component before performing the installation procedure.

### About this task

The following image indicates the location of the power button and provides a visual representation of the installation procedure.



**1x**  
M2x2.3

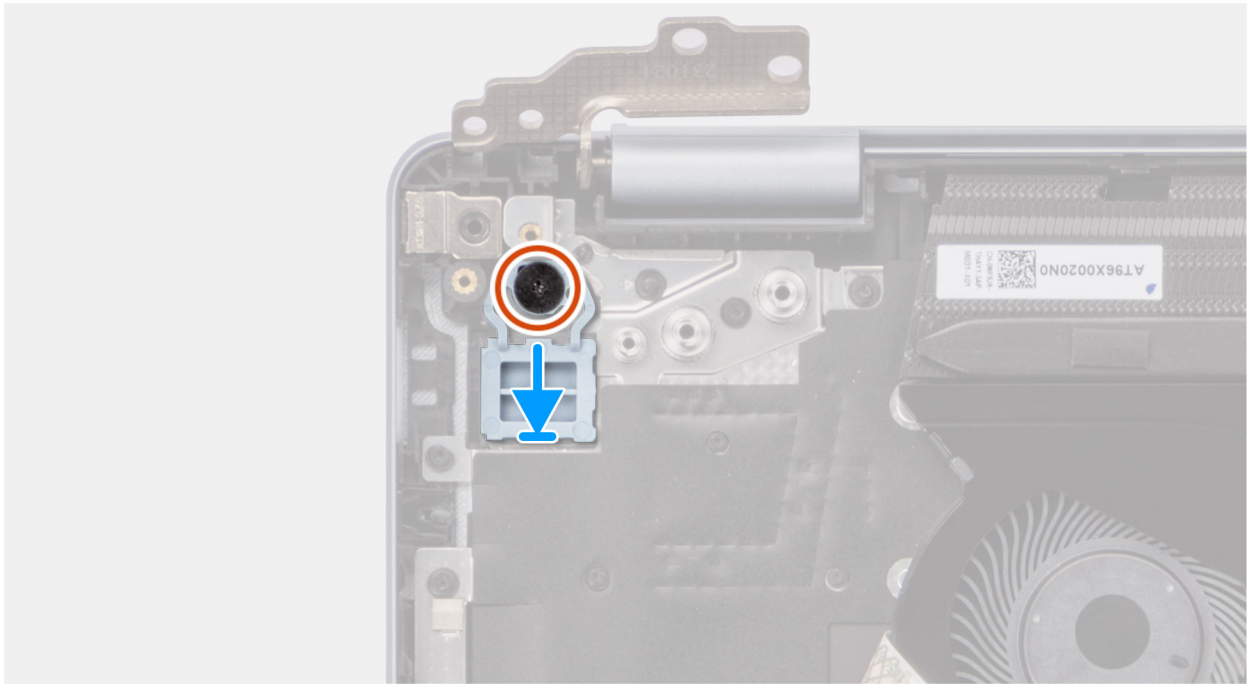
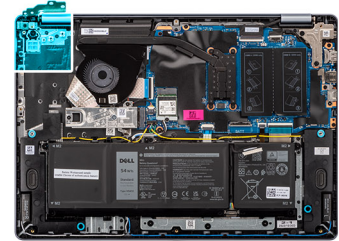

**Figure 43. Installing the power button**

### Steps

1. Place the power button in the slot on the palm-rest and keyboard assembly.
2. Align the screw hole on the power button to the screw hole on the palm-rest and keyboard assembly.
3. Replace the screw (M2x2.3) to secure the power button to the palm-rest and keyboard assembly.

### Next steps

1. Install the [I/O board](#).
2. Install the [base cover](#).
3. Follow the procedure in [After working inside your computer](#).

# Power button with optional fingerprint reader

## Removing the power button with optional fingerprint reader

**CAUTION:** The information in this section is intended for authorized service technicians only.

### Prerequisites

1. Follow the procedure in [Before working inside your computer](#).
2. Remove the [base cover](#).
3. Remove the [I/O board](#).

### About this task

**NOTE:** This procedure applies only to computers shipped with a power button with fingerprint reader installed.

The following images indicate the location of the power button with the optional fingerprint reader and provide a visual representation of the removal procedure.



1x  
M2x3

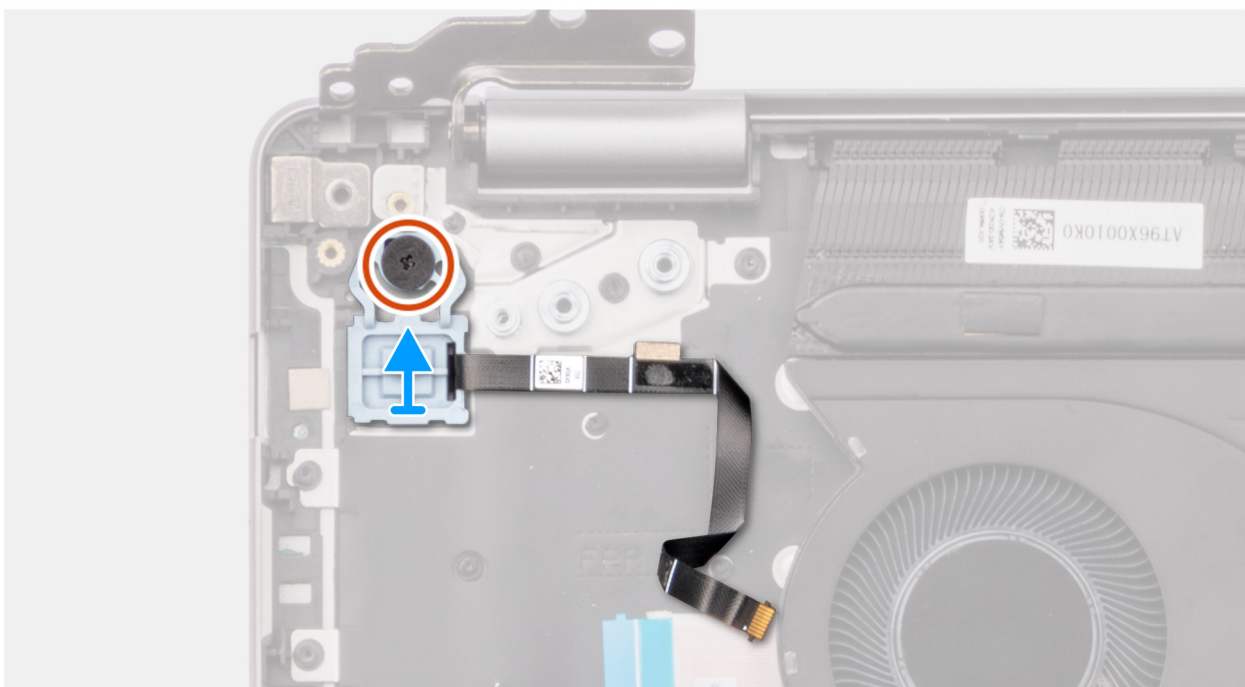
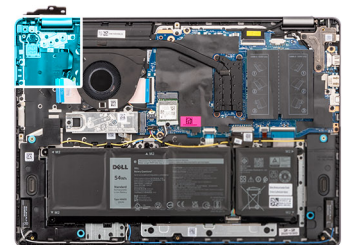

**Figure 44. Removing the power button with optional fingerprint reader**

### Steps

1. Peel the fingerprint-reader Flexible Printed Circuit (FPC) from the palm-rest and keyboard assembly.
2. Remove the screw (M2x2.3) that secures the power button with fingerprint reader FPC to the palm-rest and keyboard assembly.
3. Lift the power button, along with fingerprint reader FPC, off the slot on the palm-rest and keyboard assembly.

# Installing the power button with optional fingerprint reader

**CAUTION:** The information in this section is intended for authorized service technicians only.

## Prerequisites

If you are replacing a component, remove the existing component before performing the installation procedure.

## About this task

**NOTE:** This procedure applies only to computers shipped with a power button with fingerprint reader installed.

The following images indicate the location of the power button with the optional fingerprint reader and provide a visual representation of the installation procedure.



1x  
M2x3

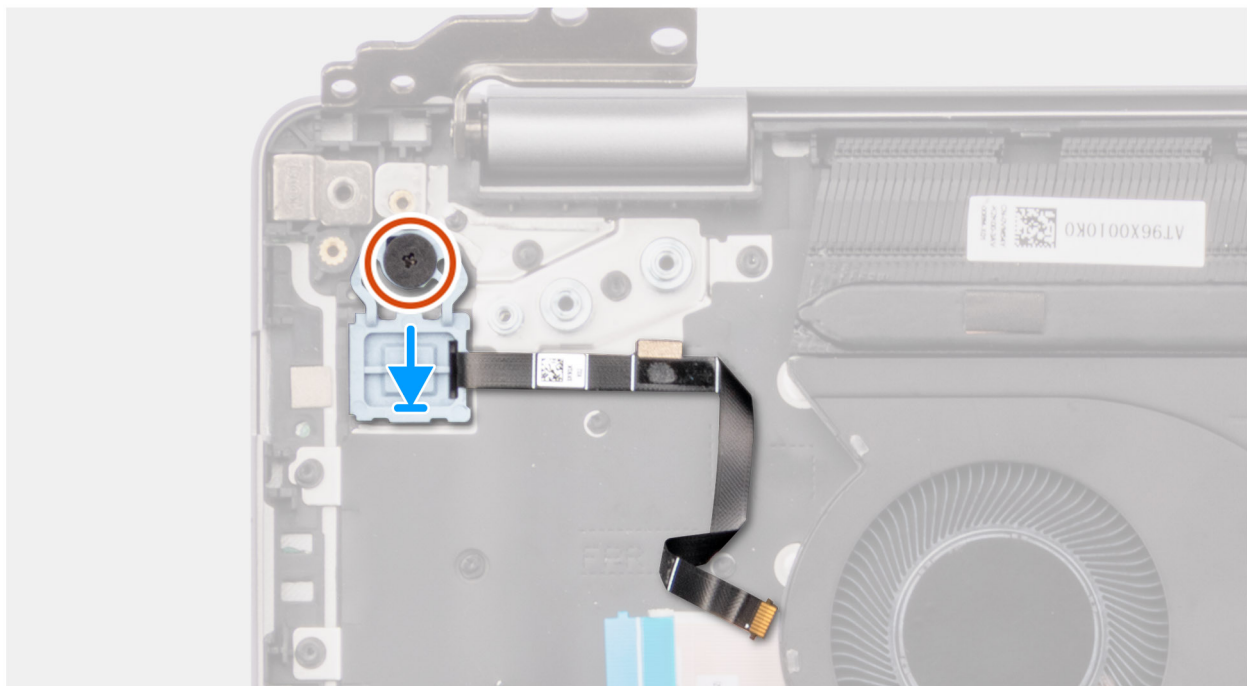
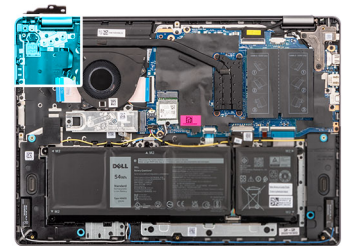
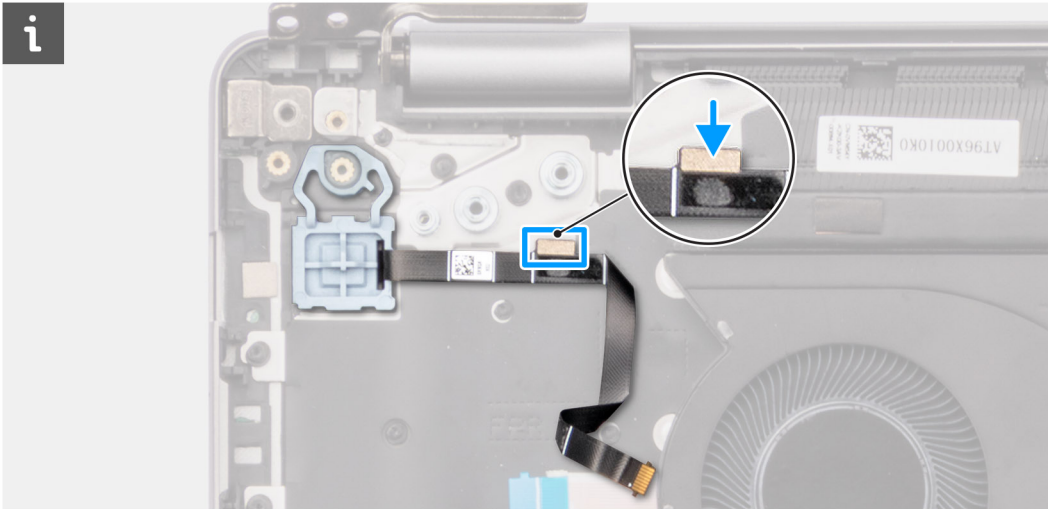

**Figure 45. Installing the power button with optional fingerprint reader**

## Steps

1. Place the power button along with fingerprint-reader cable in the slot on the palm-rest and keyboard assembly.
2. Align the screw hole on the power button to the screw hole on the palm-rest and keyboard assembly.
3. Replace the screw (M2x2.3) to secure the power button with fingerprint-reader cable to the palm-rest and keyboard assembly.
4. Adhere the fingerprint-reader cable to the palm-rest and keyboard assembly.

**NOTE:** When installing the power button, align the fingerprint-reader cable to the mark at the right of the power button. The grounding tape on the top side of the fingerprint-reader cable must be adhered to the keyboard plate



### Next steps

1. Install the [I/O board](#).
2. Install the [base cover](#).
3. Follow the procedure in [After working inside your computer](#).

## Power-adapter port

### Removing the power-adapter port

 **CAUTION:** The information in this section is intended for authorized service technicians only.

#### Prerequisites

1. Follow the procedure in [Before working inside your computer](#).
2. Remove the [base cover](#).

#### About this task

The following images indicate the location of the power-adapter port and provide a visual representation of the removal procedure.



2x  
M2.5x5

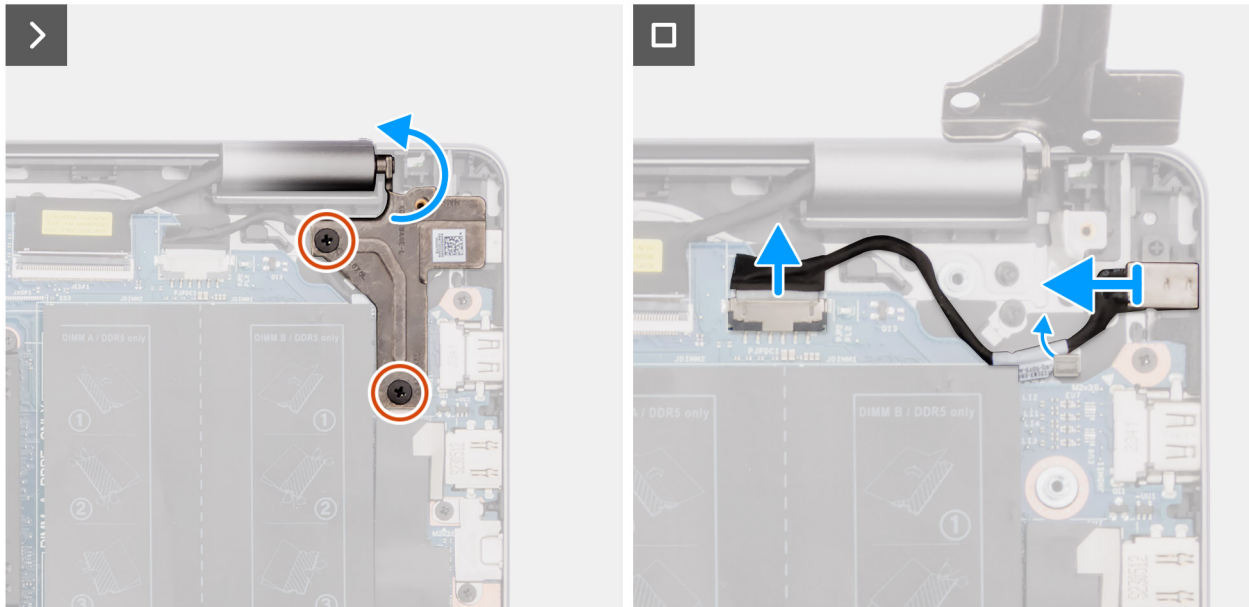
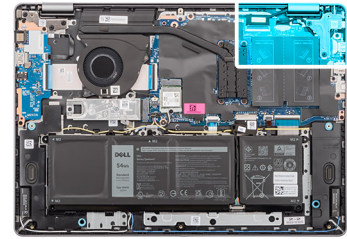

**Figure 46. Removing the power-adapter port**

### Steps

1. Remove the two screws (M2.5x5) that secure the right hinge to the system board and the palm-rest and keyboard assembly.
2. Open the right hinge at a 90 degree angle to access the power-adapter port.
3. Disconnect the power-adapter port cable from its connector (DCIN) on the system board.
4. Unroute the power-adapter port cable through the guide on the palm-rest and keyboard assembly.
5. Remove the power-adapter port from the slot on the palm-rest and keyboard assembly.

**i NOTE:** The power-adapter port is secured in place by the right hinge. There is no screw, tape, or adhesive securing the power-adapter port to the palm-rest. As a result, technicians should take note of whether the power-adapter port has fallen out of the system during subsequent removal procedures.

## Installing the power-adapter port

**CAUTION:** The information in this section is intended for authorized service technicians only.

### Prerequisites

If you are replacing a component, remove the existing component before performing the installation procedure.

### About this task

The following images indicate the location of the power-adapter port and provide a visual representation of the installation procedure.



2x  
M2.5x5

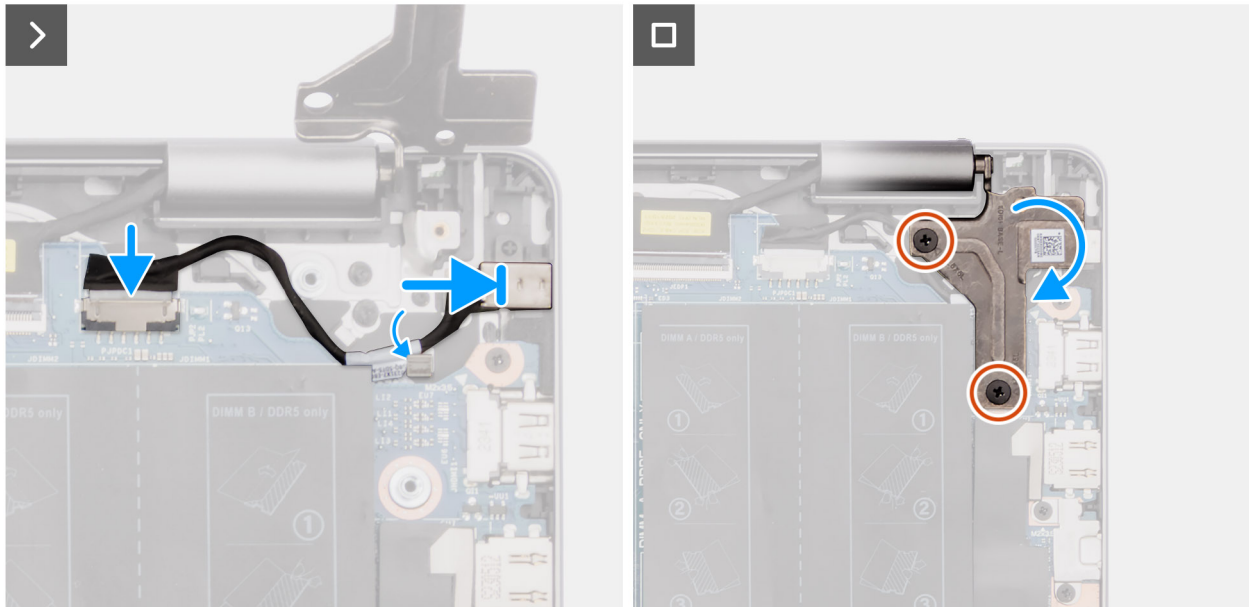
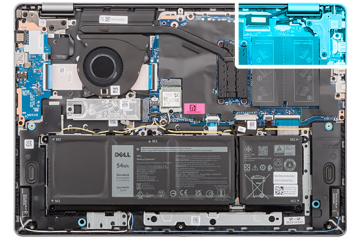

**Figure 47. Installing the power-adapter port**

### Steps

1. Align and place the power-adapter port in the slot on the palm-rest and keyboard assembly.
  - i** **NOTE:** The power-adapter port is secured in place by the right hinge. There is no screw, tape, or adhesive securing the power-adapter port to the palm-rest. As a result, technicians should take note of whether the power-adapter port has fallen out of the system during subsequent removal procedures.
2. Route the power-adapter port cable through the guide on the palm-rest and keyboard assembly.
3. Connect the power-adapter port cable to its connector (DCIN) on the system board.
4. Close the right hinge downwards to align the screw holes on the right hinge to the screw holes on the system board and the palm-rest and keyboard assembly.
5. Replace the two screws (M2.5x5) to secure the right hinge to the system board and the palm-rest and keyboard assembly.

### Next steps

1. Install the [base cover](#).
2. Follow the procedure in [After working inside your computer](#).

## System board

### Removing the system board

**⚠ CAUTION:** The information in this section is intended for authorized service technicians only.

## Prerequisites

1. Follow the procedure in [Before working inside your computer](#).
2. Remove the [base cover](#).
3. Remove the [memory module](#).
4. Remove the [solid-state drive](#).
5. Remove the [wireless card](#).
6. Remove the [fan](#).
7. Remove the [heat sink](#).

**NOTE:** When removing the system board to replace/access other parts, the system board can be removed with the heat sink attached to it in order to simplify the procedure and preserve the thermal bond between the system board and heat sink.

## About this task

The following image indicates the connectors on your system board.

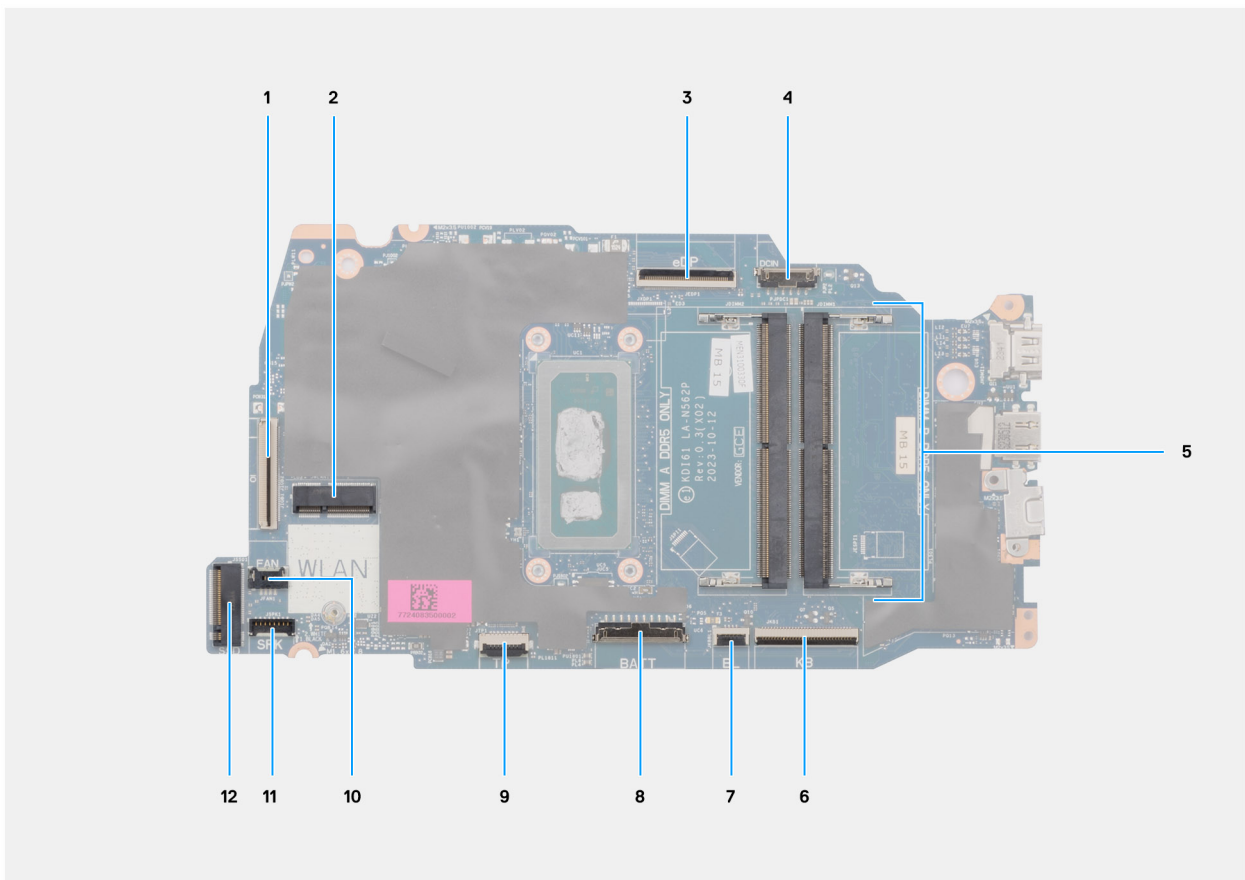

**Figure 48. System board overview**

1. I/O board cable (IO)
2. Wireless card slot (WLAN)
3. Display cable (eDP)
4. Power-adapter port cable (DCIN)
5. Memory slots x2 (DIMM A DDR5 ONLY + DIMM B DDR5 ONLY)
6. Keyboard cable (KB)
7. Keyboard-backlight cable (BL)
8. Battery cable (BATT)
9. Touchpad cable (TP)
10. Fan cable (FAN)
11. Speaker cable (SPK)
12. M.2 solid-state drive slot (SSD)



The following images indicate the location of the system board and provide a visual representation of the removal procedure.



**2x**  
M2.5x5



**5x**  
M2x3.5



**1x**  
M1.6x1.8

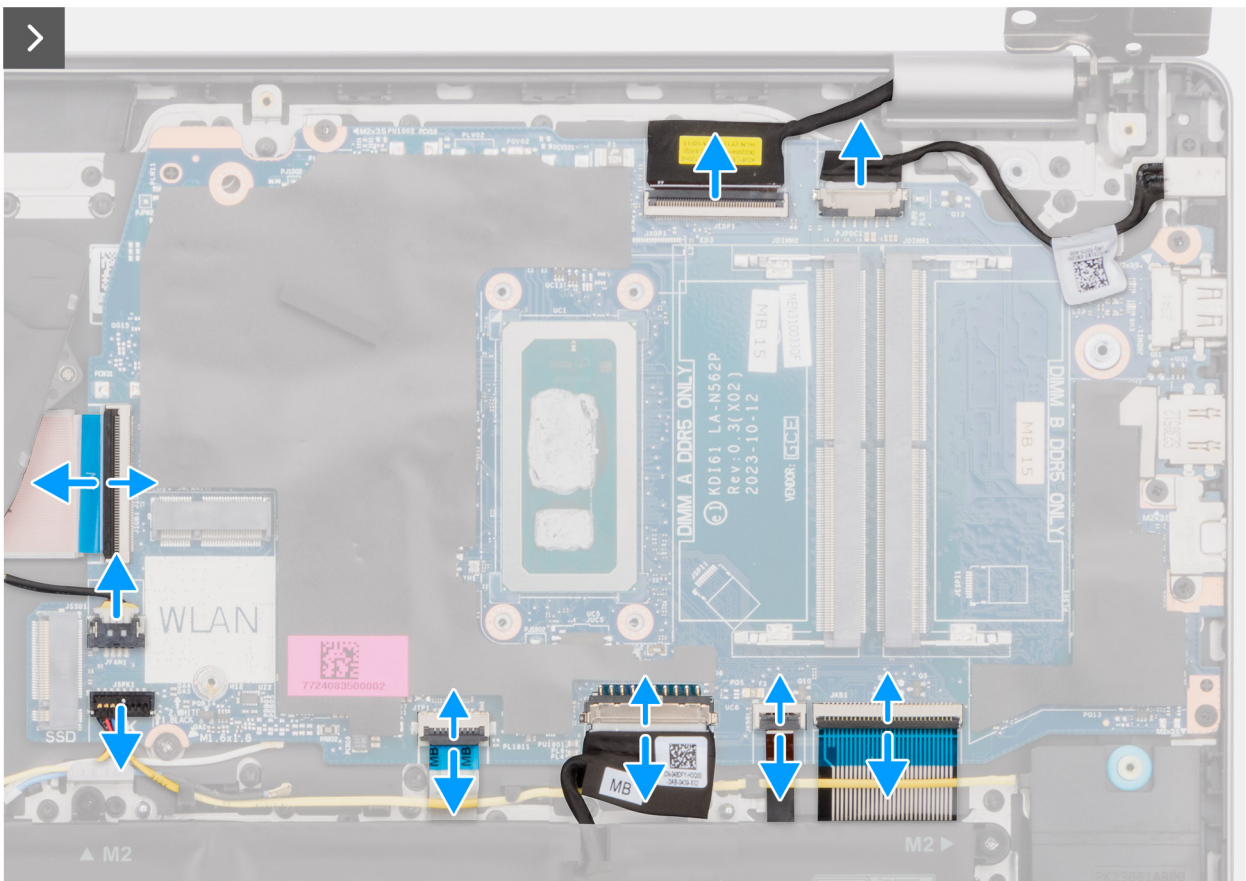
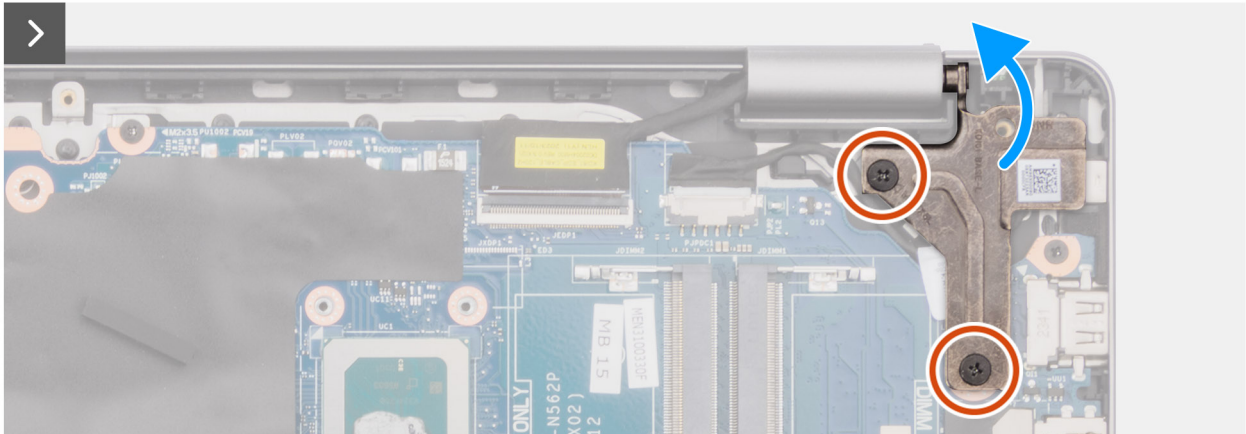
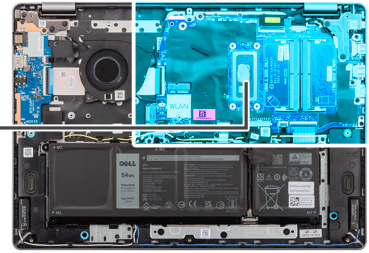

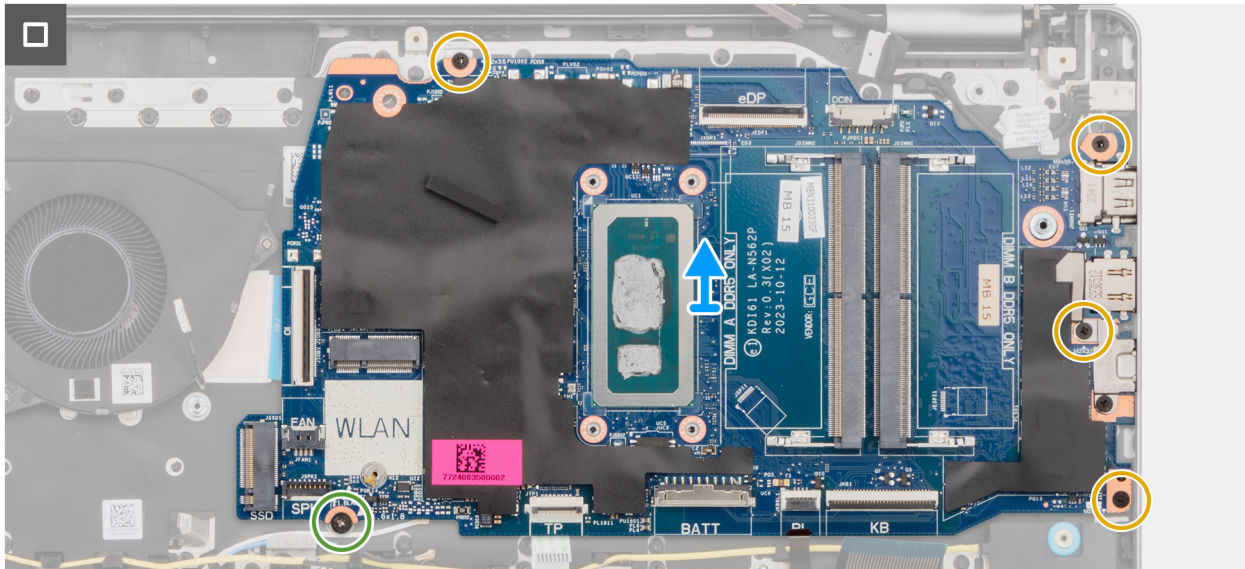
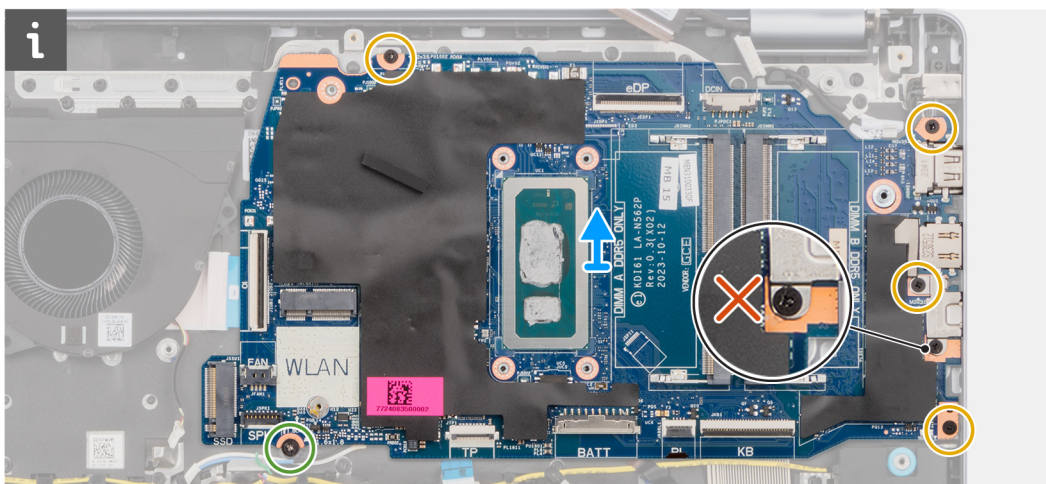

**Figure 49. Removing the system board**

**Steps**

1. Remove the two screws (M2.5x5) that secure the right hinge to the palm-rest and keyboard assembly.
2. Open the right display hinge at an angle of 90 degrees.
3. Disconnect the following cables on the system board:
  - a. eDP cable from its connector (eDP)
  - b. power-adaptor port cable from its connector (DCIN)
  - c. keyboard cable from its connector (KB)
  - d. keyboard-backlight cable from its connector (BL)
  - e. battery cable from its connector (BATT)
  - f. touchpad cable from its connector (TP)
  - g. speaker cable from its connector (SPK)
  - h. fan cable from its connector (FAN)
  - i. I/O board cable from its connector (IO)
4. Remove the screw (M1.6x1.8) that secure the system board to the palm-rest and keyboard assembly.
5. Remove the four screws (M2x3.5) that secure the system board to the palm-rest and keyboard assembly.

**NOTE:** A USB Type-C bracket is secured to the system board with a single (M2x3.5) screw. The bracket is attached with the system board as a service part and must not be removed from the system board.



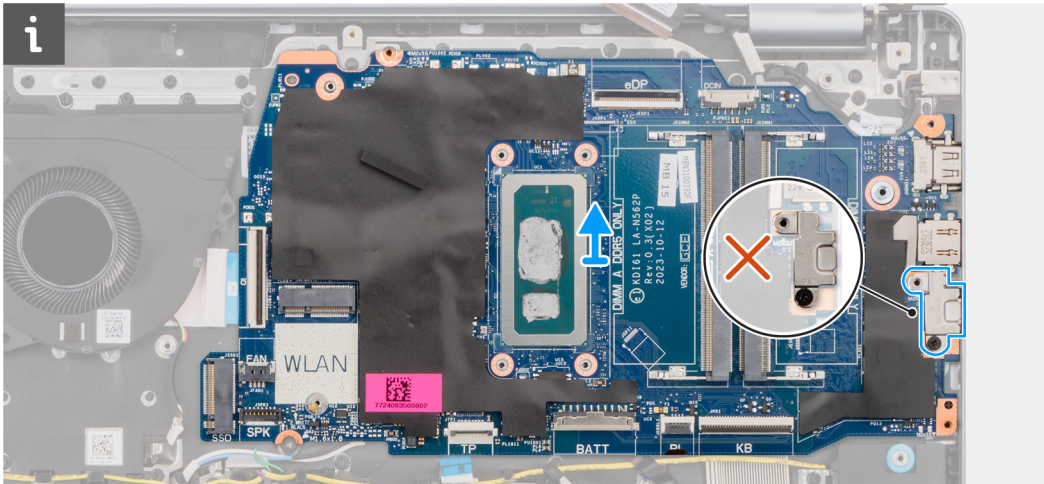

6. Carefully lift and remove the system board from the palm-rest and keyboard assembly.

## Installing the system board

**CAUTION:** The information in this section is intended for authorized service technicians only.

### Prerequisites

If you are replacing a component, remove the existing component before performing the installation procedure.

### About this task

**NOTE:** When installing the system board to replace/access other parts, the system board can be installed with the heat sink to it in order to simplify the procedure and preserve the thermal bond between the system board and heat sink.

The following image indicates the connectors on your system board.

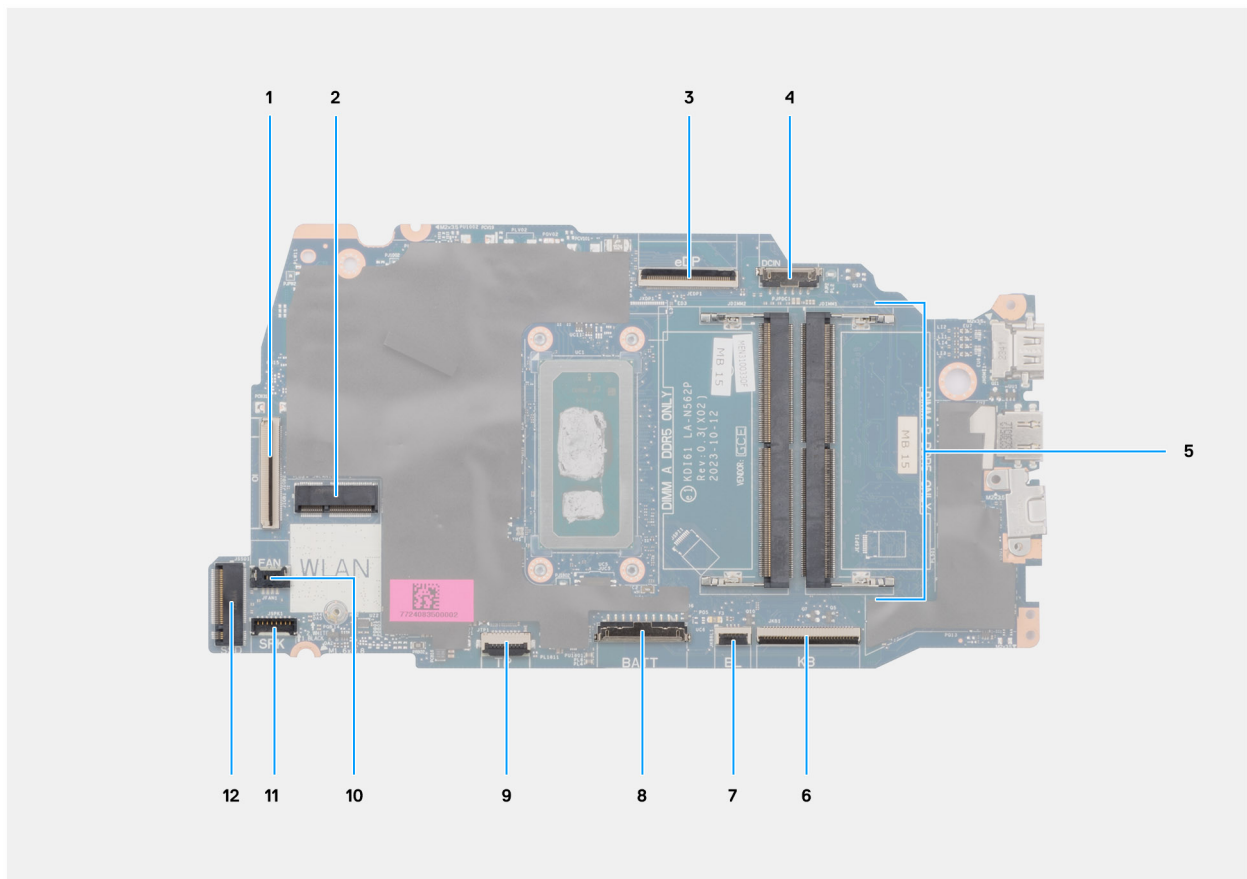

**Figure 50. System board overview**

1. I/O board cable (IO)
2. Wireless card slot (WLAN)
3. Display cable (eDP)
4. Power-adapter port cable (DCIN)
5. Memory slots x2 (DIMM A DDR5 ONLY + DIMM B DDR5 ONLY)
6. Keyboard cable (KB)
7. Keyboard-backlight cable (BL)
8. Battery cable (BATT)
9. Touchpad cable (TP)
10. Fan cable (FAN)
11. Speaker cable (SPK)
12. M.2 solid-state drive slot (SSD)

The following images indicate the location of the system board and provide a visual representation of the installation procedure.



2x  
M2.5x5



5x  
M2x3.5



1x  
M1.6x1.8

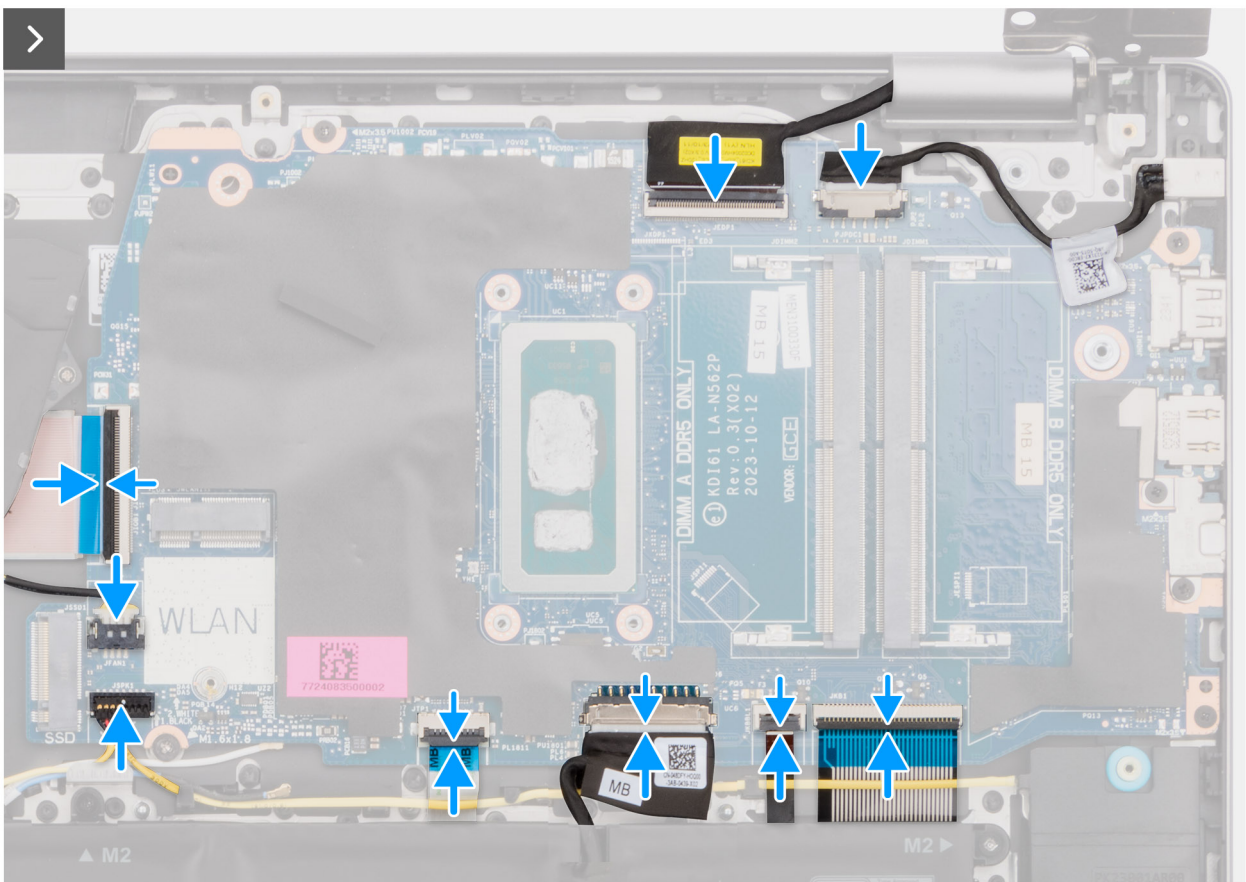
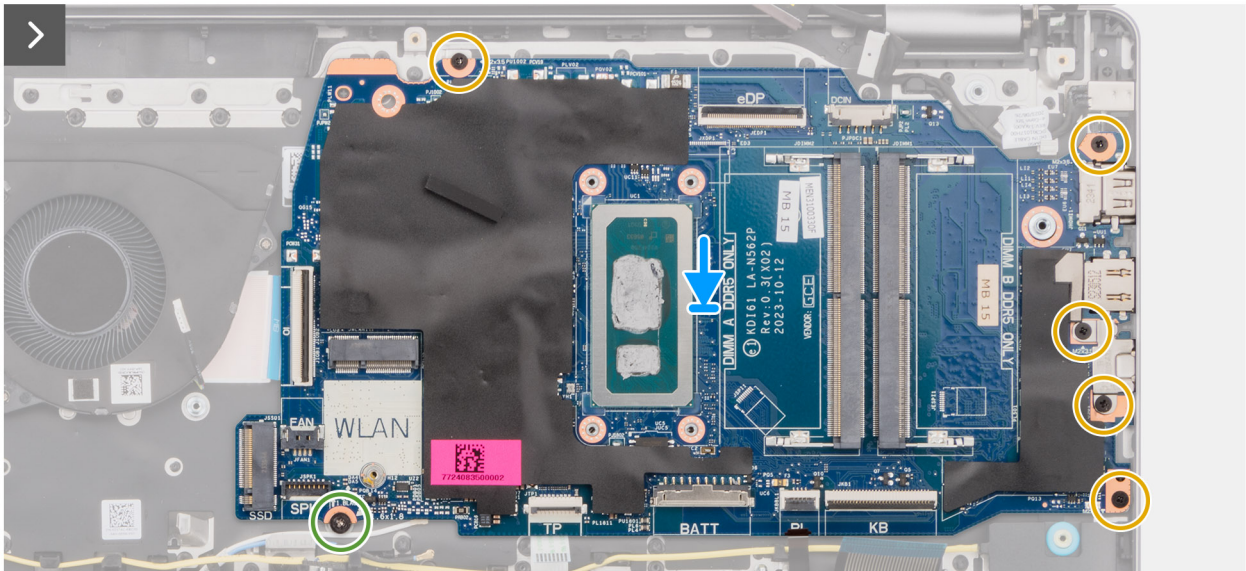
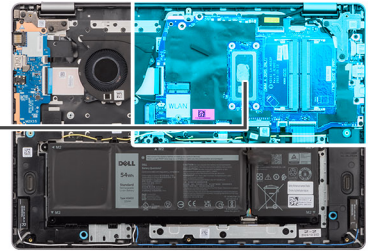

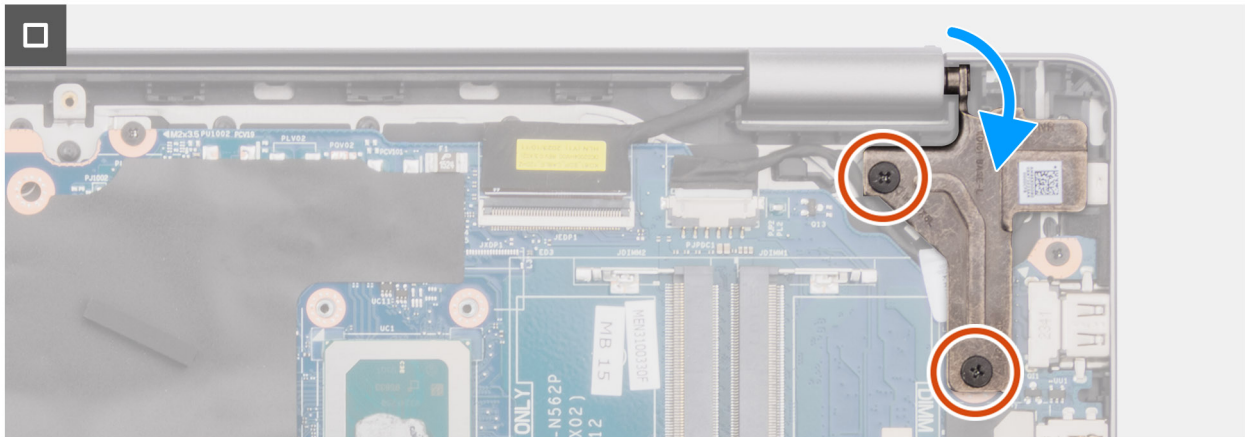

**Figure 51. Installing the system board**

### Steps

1. Align the ports on the system board to the port openings on the palm-rest and keyboard assembly.
2. At an angle, carefully slide and place the system board on the palm-rest and keyboard assembly.
3. Align the screw holes on the system board with the screw holes on the palm-rest and keyboard assembly.
4. Replace the screw (M1.6x1.8) to secure the system board to the palm-rest and keyboard assembly.
5. Replace the four screws (M2x3.5) to secure the system board to the palm-rest and keyboard assembly.
  - NOTE:** A USB Type-C bracket is secured to the system board with a single screw (M2x3.5). The bracket is bundled with the system board as a service part and **MUST NOT** be removed from the system board.
6. Connect the following cables to the system board:
  - a. I/O daughter-board cable to its connector (IO)
  - b. fan cable to its connector (FAN)
  - c. speaker cable to its connector (SPK)
  - d. touchpad cable to its connector (TP)
  - e. battery cable to its connector (BATT)
  - f. keyboard-backlight cable to its connector (BL)
  - g. keyboard cable to its connector (KB)
  - h. power-adapter port cable to its connector (DCIN)
  - i. eDP cable to its connector (eDP)
7. Close the right display hinge.
8. Replace the two screws (M2.5x5) that secure the right hinge to the palm-rest and keyboard assembly.

### Next steps

1. Install the [heat sink](#).
2. Install the [fan](#).
3. Install the [wireless card](#).
4. Install the [solid-state drive](#).
5. Install the [memory module](#).
6. Install the [base cover](#).
7. Follow the procedure in [After working inside your computer](#).

## Palm-rest and keyboard assembly

### Removing the palm-rest and keyboard assembly

**CAUTION:** The information in this section is intended for authorized service technicians only.

## Prerequisites

1. Follow the procedure in [Before working inside your computer](#).
2. Remove the [base cover](#).
3. Remove the [memory module](#).
4. Remove the [solid-state drive](#).
5. Remove the [wireless card](#).
6. Remove the [speakers](#).
7. Remove the [fan](#).
8. Remove the [battery](#).
9. Remove the [heat sink](#).
10. Remove the [touchpad assembly](#).
11. Remove the [I/O-board cable](#).
12. Remove the [display assembly](#).
13. Remove the [I/O board](#).
14. Remove the [power button](#) or the [power button with optional fingerprint reader](#), whichever is applicable.
15. Remove the [power-adaptor port](#).
16. Remove the [system board](#).

**i NOTE:** The system board can be removed with the heat sink attached to it in order to simplify the procedure and preserve the thermal bond between the system board and heat sink.

## About this task

**i NOTE:** The palm-rest and keyboard assembly cannot be further disassembled once all the pre-removal parts procedures are completed. If the keyboard is malfunctioning and is required to be replaced, replace the entire palm-rest and keyboard assembly.

The image below shows the palm-rest and keyboard assembly after the pre-removal parts procedures have been performed for any palm-rest and keyboard assembly replacement.

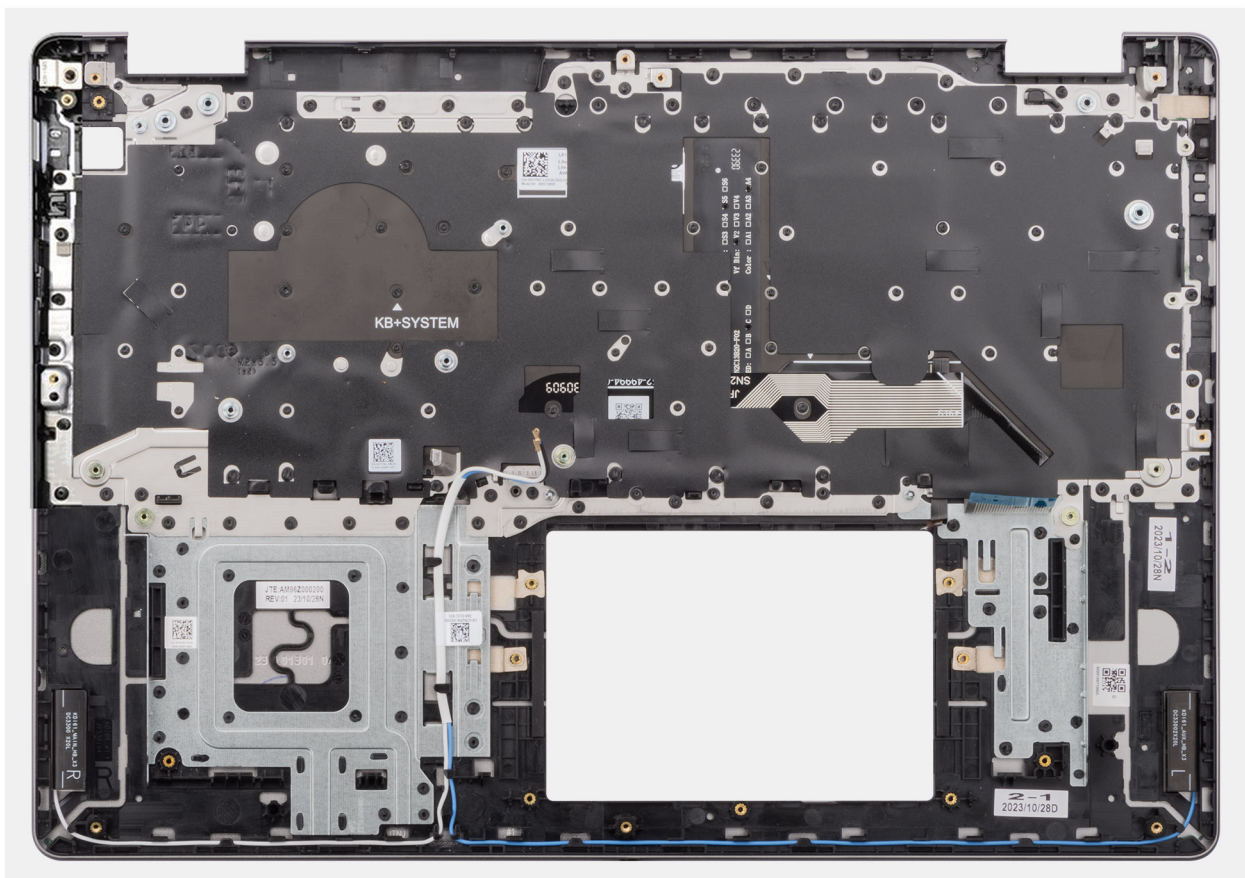

**Figure 52. Removing the palm-rest and keyboard assembly**

## Steps

After performing the pre-requisites, you are left with the palm-rest and keyboard assembly.

## Installing the palm-rest and keyboard assembly

**CAUTION:** The information in this section is intended for authorized service technicians only.

### Prerequisites

If you are replacing a component, remove the existing component before performing the installation procedure.

### About this task

**NOTE:** The system board can be installed with the heat sink attached to it in order to simplify the procedure and preserve the thermal bond between the system board and heat sink.

The following image indicates the location of the palm-rest and keyboard assembly and provides a visual representation of the installation procedure.

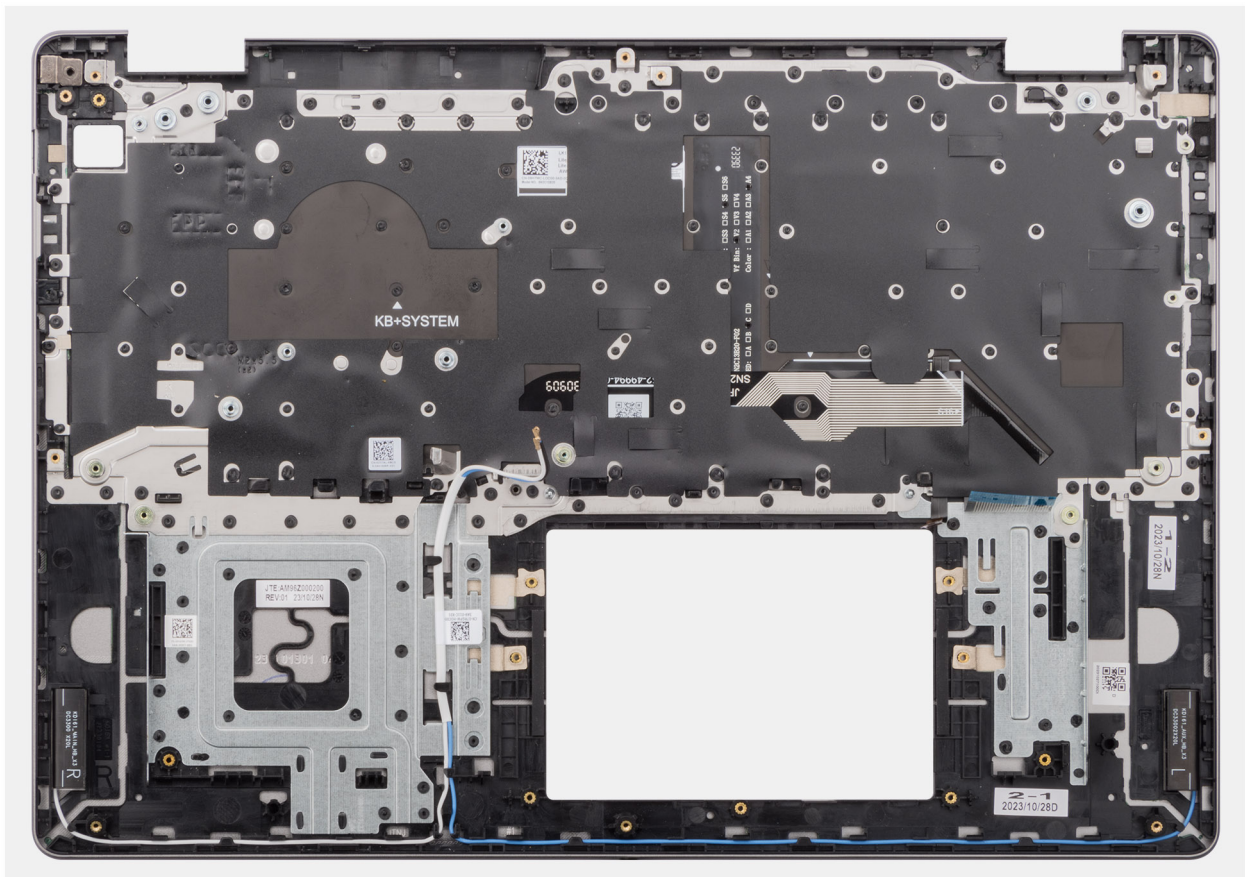

**Figure 53. Installing the palm-rest and keyboard assembly**

## Steps

Place the palm-rest and keyboard assembly on a flat surface and perform the post-requisites to install the palm-rest and keyboard assembly.

### Next steps

1. Install the [system board](#).
2. Install the [power-adaptor port](#).
3. Install the [power button](#) or the [power button with optional fingerprint reader](#), whichever is applicable.



4. Install the [I/O board](#).
5. Install the [display assembly](#).
6. Install the [I/O-board cable](#).
7. Install the [touchpad assembly](#).
8. Install the [heat sink](#).
9. Install the [battery](#).
10. Install the [fan](#).
11. Install the [speakers](#).
12. Install the [wireless card](#).
13. Install the [solid-state drive](#).
14. Install the [memory module](#).
15. Install the [base cover](#).
16. Follow the procedure in [After working inside your computer](#).

# Software

This chapter details the supported operating systems along with instructions on how to install the drivers.

## Operating system

Your Vostro 16 5640 supports the following operating systems:

- Windows 11 Home
- Windows 11 Home (S Mode)
- Windows 11 Pro
- Windows 11 Pro National Academic
- Ubuntu Linux 22.04 LTS

## Drivers and downloads

When troubleshooting, downloading, or installing drivers, it is recommended that you read the Dell Knowledge Base article [Drivers and Downloads FAQs 000123347](#).

# BIOS Setup

**CAUTION:** Unless you are an expert computer user, do not change the settings in the BIOS Setup. Certain changes can make your computer work incorrectly.

**NOTE:** Depending on the computer and its installed devices, the items that are listed in this section may or may not be displayed.

**NOTE:** Before you change the settings in BIOS Setup, it is recommended that you note down the original settings for future reference.

Use BIOS Setup for the following purposes:

- Get information about the hardware installed in your computer, such as the amount of RAM and the size of the storage device.
- Change the system configuration information.
- Set or change a user-selectable option, such as the user password, type of hard drive installed, and enabling or disabling base devices.

## Entering BIOS setup program

### About this task

Turn on (or restart) your computer and press F10 immediately.

## Navigation keys

**NOTE:** For most of the System Setup options, changes that you make are recorded but do not take effect until you restart the computer.

**Table 31. Navigation keys**



Keys	Navigation
Up arrow	Moves to the previous field.
Down arrow	Moves to the next field.
Enter	Selects a value in the selected field (if applicable) or follows the link in the field.
Spacebar	Expands or collapses a drop-down list, if applicable.
Tab	Moves to the next focus area. <b>NOTE:</b> For the standard graphical user interface only.
Esc	Moves to the previous page until you view the main screen. Pressing Esc in the main screen displays a message that prompts you to save any unsaved changes and restart the computer.

## F12 One Time Boot menu

To enter the One Time Boot menu, turn on your computer, and then press F12 immediately.

 **NOTE:** It is recommended to shut down the computer, if it is on.

The F12 One Time Boot menu displays the devices that you can boot from including the diagnostic option. The boot menu options are:

- Windows Boot Manager
  -  **NOTE:** Windows Boot Manager shows up only if the computer has been booted to the operating system.
- UEFI RST XXXX
  -  **NOTE:** XXXX denotes the solid-state drive device name.
- ONBOARD NIC (IPV4)
- ONBOARD NIC (IPV6)
- UEFI HTTPs Boot (MAC: XXXX)
  -  **NOTE:** XXXX depends on LAN's MAC address.

## System setup options

 **NOTE:** Depending on your computer and its installed devices, the items that are listed in this section may or may not be displayed.

**Table 32. System setup options—Overview menu**

Overview	
<b>Vostro 16 5640</b>	
BIOS Version	Displays the BIOS version number.
Service Tag	Displays the Service Tag of the computer.
Asset Tag	Displays the Asset Tag of the computer.
Manufacture Date	Displays the manufacture date of the computer.
Ownership Date	Displays the ownership date of the computer.
Express Service Code	Displays the Express Service Code of the computer.
Ownership Tag	Displays the Ownership Tag of the computer.
Signed Firmware Update	Displays whether the Signed Firmware Update is enabled on your computer. By default, the <b>Signed Firmware Update</b> option is enabled.
<b>Battery Information</b>	
Primary	Displays the primary battery of the computer.
Battery Level	Displays the battery level of the computer.
Battery State	Displays the battery state of the computer.
Health	Displays the battery health of the computer.
AC Adapter	Displays whether an AC adapter is connected. If connected, displays the type of AC adapter that is connected.
Battery Life Type	Displays the battery life of the computer.
<b>Processor Information</b>	
Processor Type	Displays the processor type.
Maximum Clock Speed	Displays the maximum processor clock speed.
Minimum Clock Speed	Displays the minimum processor clock speed.
Current Clock Speed	Displays the current processor clock speed.

**Table 32. System setup options—Overview menu (continued)**

<b>Overview</b>	
Core Count	Displays the number of cores on the processor.
Processor ID	Displays the processor identification code.
Processor L2 Cache	Displays the processor L2 Cache size.
Processor L3 Cache	Displays the processor L3 Cache size.
Microcode Version	Displays the microcode version.
Intel Hyper-Threading Capable	Displays whether the processor is Hyper-Threading (HT) capable.
64-Bit Technology	Displays whether 64-bit technology is used.
<b>Memory Information</b>	
Memory Installed	Displays the total computer memory installed.
Memory Available	Displays the total computer memory available.
Memory Speed	Displays the memory speed.
Memory Channel Mode	Displays single or dual channel mode.
Memory Technology	Displays the technology that is used for the memory.
DIMM A Size	Displays the DIMM A size.
DIMM B Size	Displays the DIMM B size.
<b>Devices Information</b>	
Panel Type	Displays the Panel Type of the computer.
Video Controller	Displays the video controller type of the computer.
Video Memory	Displays the video memory information of the computer.
Wi-Fi Device	Displays the wireless device information of the computer.
Native Resolution	Displays the native resolution of the computer.
Video BIOS Version	Displays the video BIOS version of the computer.
Audio Controller	Displays the audio controller information of the computer.
Bluetooth Device	Displays the Bluetooth device information of the computer.
LOM MAC Address	Display the MAC address of the LAN on the system board of the computer.

**Table 33. System setup options—Boot Configuration menu**

<b>Boot Configuration</b>	
<b>Boot Sequence</b>	
Boot Mode: UEFI only	Displays the boot mode of the computer.
Boot Sequence	Displays the boot sequence.
Enable PXE Boot Priority	Enables or disables the new PXE boot option. Allows loading an operating system over a network connection.  By default, the <b>Enable PXE Boot Priority</b> option is disabled.
<b>Secure Boot</b>	
	Secure Boot is a method of guaranteeing the integrity of the boot path by performing additional validation of the operating system and PCI add-in cards. The computer stops booting to the operating system when a component is not authenticated during the boot process. Secure Boot can be enabled and disabled from BIOS setup.
Enable Secure Boot	Enables the computer to boot using only validated boot software.

**Table 33. System setup options—Boot Configuration menu (continued)**

<b>Boot Configuration</b>	
	<p>By default, the <b>Enable Secure Boot</b> option is enabled.</p> <p>For additional security, Dell Technologies recommends keeping the <b>Secure Boot</b> option enabled to ensure that the UEFI firmware validates the operating system during the boot process.</p> <p><b>i</b> <b>NOTE:</b> For Secure Boot to be enabled, the computer is required to be in UEFI boot mode and the Enable Legacy Option ROMs option is required to be turned off.</p>
Enable Microsoft UEFI CA	<p>When disabled, the UEFI CA is removed from the BIOS UEFI Secure Boot database.</p> <p><b>i</b> <b>NOTE:</b> When disabled, the Microsoft UEFI CA could render your computer unable to boot, computer graphics may not function, some devices may not function properly, and the computer could become unrecoverable.</p> <p>By default, the <b>Enable Microsoft UEFI CA</b> option is enabled.</p> <p>For additional security, Dell Technologies recommends keeping the <b>Microsoft UEFI CA</b> option enabled to ensure the broadest compatibility with devices and operating systems.</p>
Secure Boot Mode	<p>Enables or disables the Secure Boot operation mode.</p> <p>By default, the <b>Deployed Mode</b> is selected.</p> <p><b>i</b> <b>NOTE:</b> <b>Deployed Mode</b> should be selected for normal operation of Secure Boot.</p>
<b>Expert Key Management</b>	
Enable Custom Mode	<p>Enables or disables the keys in the PK, KEK, db, and dbx security key databases to be modified.</p> <p>By default, the <b>Enable Custom Mode</b> option is disabled.</p>
Custom Mode Key Management	<p>Selects the custom values for expert key management.</p> <p>By default, the <b>PK</b> option is selected.</p>

**Table 34. System setup options—Integrated Devices menu**

<b>Integrated Devices</b>	
<b>Date/Time</b>	
Date	Sets the computer date in MM/DD/YYYY format. Changes to the date format take effect immediately.
Time	Sets the computer time in HH/MM/SS 24-hour format. You can switch between a 12-hour and 24-hour clock. Changes to the time format take effect immediately.
<b>Camera</b>	
Enable Camera	<p>Enables the camera.</p> <p>By default, the <b>Enable Camera</b> option is enabled.</p>
<b>Audio</b>	
Enable Audio	<p>Enables all integrated audio controller.</p> <p>By default, all the options are enabled.</p>
Enable Microphone	<p>Enables the microphone.</p> <p>By default, the <b>Enable Microphone</b> option is enabled.</p>

**Table 34. System setup options—Integrated Devices menu (continued)**

<b>Integrated Devices</b>	
	<p> <b>NOTE:</b> Depending on the configuration ordered, the microphone setup option may not be available.</p>
Enable Internal Speaker	<p>Enables the internal speaker.</p> <p>By default, the <b>Enable Internal Speaker</b> option is enabled.</p>
<b>USB Configuration</b>	
Enable USB Boot Support	<p>Enables booting from USB mass storage devices that are connected to external USB ports.</p> <p>By default, the <b>Enable USB Boot Support</b> option is enabled.</p>
<b>Miscellaneous Devices</b>	
Enable Fingerprint Reader Device	<p>Enables or disables the Fingerprint Reader Device, if available.</p> <p>By default, the <b>Enable Fingerprint Reader Device</b> option is selected.</p>

**Table 35. System setup options—Storage menu**

<b>Storage</b>	
<b>SATA/NVMe Operation</b>	
SATA/NVMe Operation	<p>Sets the operating mode of the integrated storage device controller.</p> <p>By default, the <b>RAID On</b> option is selected. The storage device is configured to support RAID functions with VMD Controller.</p>
<b>Storage Interface</b>	
Port Enablement	<p>Displays the information of various onboard drives.</p> <p>Enables or disables the M.2 PCIe SSD option.</p> <p>By default, the <b>M.2 PCIe SSD</b> option is enabled.</p>
<b>Drive Information</b>	
	<p>Displays the information of onboard drives.</p>

**Table 36. System setup options—Display menu**

<b>Display</b>	
<b>Display Brightness</b>	
Brightness on battery power	<p>Enables to set the screen brightness when the computer is running on battery power.</p> <p>By default, the screen brightness is set to 50 when the computer is running on battery power.</p>
Brightness on AC power	<p>Enables to set the screen brightness when the computer is running on AC power.</p> <p>By default, the screen brightness is set to 100 when the computer is running on AC power.</p>

**Table 37. System setup options—Security menu**

<b>Security</b>	
<b>TPM 2.0 Security</b>	
Clear	<p>When enabled, the <b>Clear</b> option clears information that is stored in the TPM after exiting the computer's BIOS. This option returns to the disabled state when the computer restarts.</p> <p>By default, the <b>Clear</b> option is disabled.</p>

**Table 37. System setup options—Security menu (continued)**

<b>Security</b>	
	Dell Technologies recommends enabling the <b>Clear</b> option only when TPM data is required to be cleared.
PPI Bypass for Clear Commands	<p>Allows you to control the TPM Physical Presence Interface (PPI). When enabled, this setting allows the OS to skip BIOS PPI user prompts when issuing the Clear command.</p> <p>By default, the <b>PPI Bypass for Clear Commands</b> option is disabled.</p> <p>For additional security, Dell Technologies recommends keeping the <b>PPI Bypass for Clear Commands</b> option disabled.</p>
<b>Data Wipe on Next Boot</b>	
Start Data Wipe	<p>Data Wipe is a secure wipe operation that deletes information from a storage device.</p> <p> <b>CAUTION: The secure Data Wipe operation deletes information in a way that it cannot be reconstructed.</b></p> <p>Commands such as delete and format in the operating system may remove files from showing up in the file system. However, they can be reconstructed through forensic means as they are still represented on the physical media. Data Wipe prevents this reconstruction and is not recoverable.</p> <p>When enabled, the data wipe option will prompt to wipe any storage devices that are connected to the computer on the next boot.</p> <p>By default, the <b>Start Data Wipe</b> option is disabled.</p>

**Table 38. System setup options—Passwords menu**

<b>Passwords</b>	
<b>Admin Password</b>	<p>The Administrator Password prevents unauthorized access to the BIOS Setup options. Once the administrator password is set, the BIOS setup options can only be modified after providing the correct password.</p> <p>The following rules and dependencies apply to the Administrator Password -</p> <ul style="list-style-type: none"> <li>• The administrator password cannot be set if computer and/or internal hard drive passwords are previously set.</li> <li>• The administrator password can be used in place of the computer and/or internal hard drive passwords.</li> <li>• When set, the administrator password must be provided during a firmware update.</li> <li>• Clearing the administrator password also clears the computer password (if set).</li> </ul> <p>Dell Technologies recommends using an administrator password to prevent unauthorized changes to BIOS setup options.</p>
<b>System Password</b>	<p>The System Password prevents the computer from booting to an operating system without entering the correct password.</p> <p>The following rules and dependencies apply when the System Password is used -</p> <ul style="list-style-type: none"> <li>• The computer shuts down when idle for approximately 10 minutes at the computer password prompt.</li> <li>• The computer shuts down after three incorrect attempts to enter the computer password.</li> <li>• The computer shuts down when the <b>Esc</b> key is pressed at the System Password prompt.</li> <li>• The computer password is not prompted when the computer resumes from standby mode.</li> </ul> <p>Dell Technologies recommends using the computer password in situations where it is likely that a computer may be lost or stolen.</p>



**Table 38. System setup options—Passwords menu (continued)**

<b>Passwords</b>	
<b>M.2 PCIe SSD-0</b>	Enables the user to set, change, or delete the M.2 PCIe SSD-0 password.

**Table 39. System setup options—Update, Recovery menu**

<b>Update, Recovery</b>	
<b>SupportAssist OS Recovery</b>	Enables or disables the boot flow for SupportAssist OS Recovery tool in the event of certain computer errors.  By default, the <b>SupportAssist OS Recovery</b> option is enabled.
<b>BIOSConnect</b>	Enables or disables cloud Service operating system recovery if the main operating system fails to boot with the number of failures equal to or greater than the value specified by the Auto operating system Recovery Threshold setup option and the local Service operating system does not boot or is not installed.  By default, the <b>BIOSConnect</b> option is enabled.
<b>Dell Auto OS Recovery Threshold</b>	Allows you to control the automatic boot flow for SupportAssist System Resolution Console and for Dell operating system Recovery Tool.  By default, the <b>Dell Auto OS Recovery Threshold</b> value is set to 2.

**Table 40. System setup options—System Management menu**

<b>System Management</b>	
<b>Service Tag</b>	Displays the Service Tag of the computer.
<b>Asset Tag</b>	Creates a computer Asset Tag that can be used by an IT administrator to uniquely identify a particular computer.   <b>NOTE:</b> Once set in the BIOS, the Asset Tag cannot be changed.
<b>Diagnostics</b>	
<b>OS Agent Requests</b>	Enables or disables the Dell OS Agent to schedule onboard diagnostics on a subsequent boot. Enabling this option helps prevention and resolution of hardware-related issues.  By default, the option is enabled.

**Table 41. System setup options—Keyboard menu**

<b>Keyboard</b>	
<b>Keyboard Illumination</b>	Configures the operating mode of the keyboard illumination feature.  By default, the <b>Bright</b> option is selected. Enables the keyboard illumination feature at 50% brightness level.
<b>Keyboard Backlight Timeout on AC</b>	Sets the timeout value for the keyboard backlight when an AC adapter is connected to the computer.  By default, the <b>1 minute</b> option is selected.
<b>Keyboard Backlight Timeout on Battery</b>	Sets the timeout value for the keyboard backlight when the computer is running only on the battery power. The keyboard backlight timeout value is only effective when the backlight is enabled.  By default, the <b>1 minute</b> option is selected.

**Table 42. System setup options—Preboot Behavior menu**

<b>Preboot Behavior</b>	
<b>Adapter Warnings</b>	

**Table 42. System setup options—Preboot Behavior menu (continued)**

Preboot Behavior	
Enable Adapter Warnings	Enables or disables the computer to display adapter warning messages when adapters with too little power capacity are detected.  By default, the option is enabled.
Warnings and Errors	Enables or disables the action to be taken when a warning or error is encountered.  By default, the <b>Prompt on Warnings and Errors</b> option is selected. Stop, prompt, and wait for user input when warnings or errors are detected.   <b>NOTE:</b> Errors deemed critical to the operation of the computer hardware stop the functioning of the computer.

**Table 43. System setup options—System Logs menu**

System Logs	
<b>BIOS Event Log</b>	
Clear BIOS Event Log	Allows you to select option to keep or clear BIOS events logs.  By default, the <b>Keep Log</b> option is selected.
<b>Thermal Event Log</b>	
Clear Thermal Event Log	Allows you to select option to keep or clear Thermal events logs.  By default, the <b>Keep Log</b> option is selected.
<b>Power Event Log</b>	
Clear Power Event Log	Allows you to select option to keep or clear Power events logs.  By default, the <b>Keep Log</b> option is selected.

## Updating the BIOS

### Updating the BIOS in Windows

#### About this task

 **CAUTION:** If BitLocker is not suspended before updating the BIOS, the next time you reboot the computer it will not recognize the BitLocker key. You will then be prompted to enter the recovery key to progress, and the computer will ask for this on each reboot. If the recovery key is not known this can result in data loss or an unnecessary operating system reinstall. For more information about this subject, search in the Knowledge Base Resource at [www.dell.com/support](http://www.dell.com/support).

#### Steps

1. Go to [www.dell.com/support](http://www.dell.com/support).
2. Click **Product support**. In the **Search support** box, enter the Service Tag of your computer, and then click **Search**.  
 **NOTE:** If you do not have the Service Tag, use the SupportAssist feature to automatically identify your computer. You can also use the product ID or manually browse for your computer model.
3. Click **Drivers & Downloads**. Expand **Find drivers**.
4. Select the operating system installed on your computer.
5. In the **Category** drop-down list, select **BIOS**.
6. Select the latest version of BIOS, and click **Download** to download the BIOS file for your computer.
7. After the download is complete, browse the folder where you saved the BIOS update file.

8. Double-click the BIOS update file icon and follow the on-screen instructions.  
For more information, search in the Knowledge Base Resource at [www.dell.com/support](http://www.dell.com/support).

## Updating the BIOS in Linux and Ubuntu

To update the system BIOS on a computer that is installed with Linux or Ubuntu, see the knowledge base article [000131486](http://www.dell.com/support) at [www.dell.com/support](http://www.dell.com/support).

## Updating the BIOS using the USB drive in Windows

### About this task

**CAUTION:** If BitLocker is not suspended before updating the BIOS, the next time you reboot the computer it will not recognize the BitLocker key. You will then be prompted to enter the recovery key to progress, and the computer will ask for this on each reboot. If the recovery key is not known this can result in data loss or an unnecessary operating system reinstall. For more information about this subject, search in the Knowledge Base Resource at [www.dell.com/support](http://www.dell.com/support).

### Steps

1. Follow the procedure from step 1 to step 6 in [Updating the BIOS in Windows](#) to download the latest BIOS setup program file.
2. Create a bootable USB drive. For more information, search in the Knowledge Base Resource at [www.dell.com/support](http://www.dell.com/support).
3. Copy the BIOS setup program file to the bootable USB drive.
4. Connect the bootable USB drive to the computer that needs the BIOS update.
5. Restart the computer and press **F12**.
6. Select the USB drive from the **One Time Boot Menu**.
7. Type the BIOS setup program filename and press **Enter**.  
The **BIOS Update Utility** appears.
8. Follow the on-screen instructions to complete the BIOS update.

## Updating the BIOS from the F12 One-Time boot menu

Update your computer BIOS using the BIOS update.exe file that is copied to a FAT32 USB drive and booting from the F12 One-Time boot menu.

### About this task

**CAUTION:** If BitLocker is not suspended before updating the BIOS, the next time you reboot the computer it will not recognize the BitLocker key. You will then be prompted to enter the recovery key to progress, and the computer will ask for this on each reboot. If the recovery key is not known this can result in data loss or an unnecessary operating system reinstall. For more information about this subject, search in the Knowledge Base Resource at [www.dell.com/support](http://www.dell.com/support).

### BIOS Update

You can run the BIOS update file from Windows using a bootable USB drive or you can also update the BIOS from the F12 One-Time boot menu on the computer.

Most of the Dell computers built after 2012 have this capability, and you can confirm by booting your computer to the F12 One-Time Boot Menu to see if BIOS FLASH UPDATE is listed as a boot option for your computer. If the option is listed, then the BIOS supports this BIOS update option.

**NOTE:** Only computers with the BIOS Flash Update option in the F12 One-Time boot menu can use this function.

### Updating from the One-Time boot menu

To update your BIOS from the F12 One-Time boot menu, you need the following:

- USB drive formatted to the FAT32 file system (key does not have to be bootable)

- BIOS executable file that you downloaded from the Dell Support website and copied to the root of the USB drive
- AC power adapter that is connected to the computer
- Functional computer battery to flash the BIOS

Perform the following steps to perform the BIOS update flash process from the F12 menu:

 **CAUTION: Do not turn off the computer during the BIOS update process. The computer may not boot if you turn off your computer.**

### Steps

1. From a turn off state, insert the USB drive where you copied the flash into a USB port of the computer.
2. Turn on the computer and press F12 to access the One-Time Boot Menu, select BIOS Update using the mouse or arrow keys then press Enter.  
The flash BIOS menu is displayed.
3. Click **Flash from file**.
4. Select an external USB device.
5. Select the file and double-click the flash target file, and then click **Submit**.
6. Click **Update BIOS**. The computer restarts to flash the BIOS.
7. The computer will restart after the BIOS update is completed.

## System and setup password

**Table 44. System and setup password**

Password type	Description
System password	Password that you must enter to log in to your system.
Setup password	Password that you must enter to access and make changes to the BIOS settings of your computer.

You can create a system password and a setup password to secure your computer.

 **CAUTION: The password features provide a basic level of security for the data on your computer.**

 **CAUTION: Anyone can access the data that is stored on your computer, when not locked and left unattended.**

 **NOTE:** System and setup password feature is disabled.

## Assigning a System or Admin password

### About this task

To enter BIOS Setup, press F2 immediately after a power-on or reboot.

### Steps

1. In the **System BIOS** or **BIOS Setup** screen, select **Passwords**.  
The **Passwords** screen is visible.
2. Click on the **Enter the new password** input field of **System or Admin Password**, whichever you want to update. Input a new password and press Enter.  
Use the following guidelines to assign the system password:
  - A password can have up to 32 characters.
  - At least one special character: "( ! " # \$ % & ' \* + , - . / : ; < = > ? @ [ \ ] ^ \_ ` { | } )" )"
  - Numbers 0 to 9.
  - Upper case letters from A to Z.
  - Lower case letters from a to z.
3. Type the password that you entered earlier in the **Confirm Password** field and press Enter.

4. In the **Password Valid** prompt, click Yes.
5. Click on APPLY CHANGES button at the bottom of the screen and OK in the confirmation prompt to apply the changes.
6. Click on EXIT button to restart.  
The computer restarts.

## Deleting or changing an existing System or Admin password

### About this task

To enter the BIOS Setup, press F2 immediately after a power-on or reboot.

### Steps

1. In the **System BIOS** or **BIOS Setup** screen, select **Passwords**.
2. Click on the **Enter the old password** input field of **System or Admin Password**, whichever you want to change. Input the existing password and press Enter.
3. Click on the input field next to **Enter the new password**.
  - a. If you want to **change the existing password**, enter the new password and press Enter. Type the new password again in the **Confirm Password** input field and press Enter.
  - b. If you want to **delete the existing password**, press Enter **twice**.
4. In the **Password Valid** prompt, click Yes.
5. Click on APPLY CHANGES button at the bottom of the screen and OK in the confirmation prompt to apply the changes.
6. Click on EXIT button to restart.  
The computer restarts.

## Clearing BIOS (System Setup) and System passwords

### About this task

To clear the system or BIOS passwords, contact Dell technical support as described at [www.dell.com/contactdell](http://www.dell.com/contactdell).

 **NOTE:** For information about how to reset Windows or application passwords, see the documentation accompanying Windows or your application.

# Troubleshooting

## Handling swollen rechargeable Li-ion batteries

Like most laptops, Dell laptops use Lithium-ion batteries. One type of Lithium-ion battery is the rechargeable Li-ion battery. Rechargeable Li-ion batteries have increased in popularity in recent years and have become standard in the electronics industry due to customer preferences for a slim form factor (especially with newer ultra-thin laptops) and long battery life. Inherent to rechargeable Li-ion battery technology is the potential for swelling of the battery cells.

A swollen battery may impact the performance of the laptop. To prevent possible further damage to the device enclosure or internal components leading to malfunction, discontinue the use of the laptop and discharge it by disconnecting the AC adapter and letting the battery drain.

Swollen batteries should not be used and should be replaced and disposed of properly. We recommend contacting Dell product support for options to replace a swollen battery under the terms of the applicable warranty or service contract, including options for replacement by a Dell authorized service technician.

The guidelines for handling and replacing rechargeable Li-ion batteries are as follows:

- Exercise caution when handling rechargeable Li-ion batteries.
- Discharge the battery before removing it from the system. To discharge the battery, unplug the AC adapter from the system and operate the system only on battery power. When the system will no longer turn on when the power button is pressed, the battery is fully discharged.
- Do not crush, drop, mutilate, or penetrate the battery with foreign objects.
- Do not expose the battery to high temperatures, or disassemble battery packs and cells.
- Do not apply pressure to the surface of the battery.
- Do not bend the battery.
- Do not use tools of any type to pry on or against the battery.
- If a battery gets stuck in a device as a result of swelling, do not try to free it as puncturing, bending, or crushing a battery can be dangerous.
- Do not attempt to reassemble a damaged or swollen battery into a laptop.
- Swollen batteries that are covered under warranty should be returned to Dell in an approved shipping container (provided by Dell)—this is to comply with transportation regulations. Swollen batteries that are not covered under warranty should be disposed of at an approved recycling center. Contact Dell product support at <https://www.dell.com/support> for assistance and further instructions.
- Using a non-Dell or incompatible battery may increase the risk of fire or explosion. Replace the battery only with a compatible battery purchased from Dell that is designed to work with your Dell computer. Do not use a battery from other computers with your computer. Always purchase genuine batteries from <https://www.dell.com> or otherwise directly from Dell.

Rechargeable Li-ion batteries can swell for various reasons such as age, number of charge cycles, or exposure to high heat. For more information about how to improve the performance and lifespan of the laptop battery and to minimize the possibility of occurrence of the issue, search Dell Laptop Battery in the Knowledge Base Resource at [www.dell.com/support](http://www.dell.com/support).

## Locate the Service Tag or Express Service Code of your Dell computer

Your Dell computer is uniquely identified with a Service Tag or Express Service Code. To view relevant support resources for your Dell computer, we recommend entering the Service Tag or Express Service Code at [www.dell.com/support](http://www.dell.com/support).

For more information about how to find the Service Tag for your computer, see [Locate the Service Tag on your computer](#).

# Dell SupportAssist Pre-boot System Performance Check diagnostics

## About this task

SupportAssist diagnostics (also known as system diagnostics) performs a complete check of your hardware. The Dell SupportAssist Pre-boot System Performance Check diagnostics is embedded with the BIOS and launched by the BIOS internally. The embedded system diagnostics provides options for particular devices or device groups allowing you to:

- Run tests automatically or in an interactive mode.
- Repeat the tests.
- Display or save test results.
- Run thorough tests to introduce additional test options to provide extra information about one or more failed devices.
- View status messages that inform you the tests are completed successfully.
- View error messages that inform you of problems encountered during testing.

 **NOTE:** Some tests for specific devices require user interaction. Always ensure that you are present at the computer terminal when the diagnostic tests are performed.

For more information, see the knowledge base article [000180971](#).

## Running the SupportAssist Pre-Boot System Performance Check

### Steps

1. Turn on your computer.
2. As the computer boots, press the F12 key as the Dell logo appears.
3. On the boot menu screen, select the **Diagnostics** option.
4. Click the arrow at the bottom left corner.  
Diagnostics front page is displayed.
5. Click the arrow in the lower-right corner to go to the page listing.  
The items that are detected are listed.
6. To run a diagnostic test on a specific device, press Esc and click **Yes** to stop the diagnostic test.
7. Select the device from the left pane and click **Run Tests**.
8. If there are any issues, error codes are displayed.  
Note the error code and validation number and contact Dell.

## Built-in self-test (BIST)

### M-BIST

M-BIST (Built In Self-Test) is the system board built-in self-test diagnostics tool that improves the diagnostics accuracy of system board Embedded Controller (EC) failures.

 **NOTE:** M-BIST can be manually initiated before Power On Self-Test (POST).

### How to run M-BIST

 **NOTE:** M-BIST must be initiated on the computer from a power-off state that is either connected to AC power or with a battery only.

1. Press and hold both the **M** key on the keyboard and the **power button** to initiate M-BIST.
2. The battery indicator LED may exhibit two states:
  - a. OFF: No fault was detected with the system board.
  - b. AMBER: Amber indicates a problem with the system board.

- If there is a failure with the system board, the battery status LED flashes one of the following error codes for 30 seconds:

**Table 45. LED error codes**

Blinking Pattern		Possible Problem
Amber	White	
2	1	CPU Failure
2	8	LCD Power Rail Failure
1	1	TPM Detection Failure
2	4	Memory/RAM failure

- If there is no failure with the system board, the LCD cycles through the solid color screens that are described in the LCD-BIST section for 30 seconds and then turn off.

## LCD Power rail test (L-BIST)

L-BIST is an enhancement to the single LED error code diagnostics and is automatically initiated during POST. L-BIST will check the LCD power rail. If there is no power being supplied to the LCD (that is if the L-BIST circuit fails), the battery status LED flashes either an error code [2,8] or an error code [2,7].

**NOTE:** If L-BIST fails, LCD-BIST cannot function as no power will be supplied to the LCD.

### How to invoke the L-BIST Test:

- Press the power button to start the computer.
- If the computer does not start up normally, look at the battery status LED:
  - If the battery status LED flashes an error code [2,7], the display cable may not be connected properly.
  - If the battery status LED flashes an error code [2,8], there is a failure on the LCD power rail of the system board, hence there is no power that is supplied to the LCD.
- For cases, when a [2,7] error code is shown, check to see if the display cable is properly connected.
- For cases when a [2,8] error code is shown, replace the system board.

## LCD Built-in Self-Test (BIST)

Dell laptops have a built-in diagnostic tool that helps you determine if the screen abnormality you are experiencing is an inherent problem with the LCD (screen) of the Dell laptop or with the video card (GPU) and computer settings.

When you notice screen abnormalities like flickering, distortion, clarity issues, fuzzy or blurry image, horizontal or vertical lines, color fade and so on, it is always a good practice to isolate the LCD (screen) by running the Built-In Self-Test (BIST).

### How to invoke the LCD BIST Test

- Power off the Dell laptop.
- Disconnect any peripherals that are connected to the laptop. Connect only the AC adapter (charger) to the laptop.
- Ensure that the LCD (screen) is clean (no dust particles on the surface of the screen).
- Press and hold the **D** key and **Power on** the laptop to enter LCD built-in self-test (BIST) mode. Continue to hold the D key until the computer boots up.
- The screen displays solid colors and change colors on the entire screen to white, black, red, green, and blue twice.
- Then it displays the colors white, black, and red.
- Carefully inspect the screen for abnormalities (any lines, fuzzy color, or distortion on the screen).
- At the end of the last solid color (red), the computer shuts down.

**NOTE:** Dell SupportAssist Preboot diagnostics upon launch initiates an LCD BIST first, expecting a user intervention to confirm functionality of the LCD.



# System-diagnostic lights

This section lists the system-diagnostic lights of your Vostro 16 5640.

**Table 46. System-diagnostic lights**

Blinking pattern		Problem description
Amber	White	
1	1	TPM detection failure
1	2	Unrecoverable SPI Flash Failure
1	3	Short in hinge cable tripped OCP1
1	4	Short in hinge cable tripped OCP2
1	5	EC unable to program i-Fuse
1	6	Generic catch-all for ungraceful EC code flow errors
1	7	Non-RPMC Flash on Boot Guard fused system
1	8	Chipset "Catastrophic Error" signal has tripped
2	1	CPU failure
2	2	System board failure (included BIOS corruption or ROM error)
2	3	No memory or RAM detected
2	4	Memory or RAM failure
2	5	Invalid memory installed
2	6	System board or Chipset Error
2	7	LCD failure (SBIOS message)
2	8	LCD failure (EC detection of power rail failure)
3	2	PCI or Video card or chip failure
3	3	BIOS Recovery image not found
3	4	BIOS Recovery image found but invalid
3	5	Power rail failure
3	6	Flash corruption is detected by SBIOS.
3	7	Timeout waiting on ME to reply to HECI message.

**NOTE:** Blinking 3-3-3 LEDs on Lock LED (Caps-Lock or Num Lock), Power button LED (without Fingerprint reader), and Diagnostic LED indicates failure to provide input during LCD panel test on Dell SupportAssist Preboot System Performance. Check diagnostics.

## Recovering the operating system

When your computer is unable to boot to the operating system even after repeated attempts, it automatically starts Dell SupportAssist OS Recovery.

Dell SupportAssist OS Recovery is a stand-alone tool that is preinstalled in all Dell computers that are installed with the Windows operating system. It consists of tools to diagnose and troubleshoot issues that may occur before your computer boots to the operating system. It enables you to diagnose hardware issues, repair your computer, back up your files, or restore your computer to its factory state.

You can also download it from the Dell Support website to troubleshoot and fix your computer when it fails to boot into their primary operating system due to software or hardware failures.

For more information about the Dell SupportAssist OS Recovery, see *Dell SupportAssist OS Recovery User's Guide* at [www.dell.com/serviceabilitytools](http://www.dell.com/serviceabilitytools). Click **SupportAssist** and then, click **SupportAssist OS Recovery**.

## Real-Time Clock (RTC Reset)

The Real Time Clock (RTC) reset function allows you or the service technician to recover Dell computers from No POST/No Power/No Boot situations. The legacy jumper enabled RTC reset has been retired on these models.

Start the RTC reset with the computer powered off and connected to AC power. Press and hold the power button for thirty (30) seconds. The computer RTC Reset occurs after you release the power button.

## Backup media and recovery options

It is recommended to create a recovery drive to troubleshoot and fix problems that may occur with Windows. Dell proposes multiple options for recovering the Windows operating system on your Dell computer. For more information, see [Dell Windows Backup Media and Recovery Options](#).

## Wi-Fi power cycle

### About this task

If your computer is unable to access the Internet due to Wi-Fi connectivity issues a Wi-Fi power cycle procedure may be performed. The following procedure provides the instructions on how to conduct a Wi-Fi power cycle:

 **NOTE:** Some Internet Service Providers (ISPs) provide a modem or router combo device.

### Steps

1. Turn off your computer.
2. Turn off the modem.
3. Turn off the wireless router.
4. Wait for 30 seconds.
5. Turn on the wireless router.
6. Turn on the modem.
7. Turn on your computer.

## Drain residual flea power (perform hard reset)

### About this task

Flea power is the residual static electricity that remains in the computer even after it has been powered off and the battery is removed.

For your safety, and to protect the sensitive electronic components in your computer, you are requested to drain residual flea power before removing or replacing any components in your computer.

Draining residual flea power, also known as a performing a "hard reset," is also a common troubleshooting step if your computer does not turn on or boot into the operating system.

Perform the following steps to drain the residual flea power:

## Steps

1. Turn off your computer.
2. Disconnect the power adapter from your computer.
3. Remove the base cover.
4. Remove the battery.



**CAUTION: The battery is a Field Replaceable Unit (FRU) and the removal/installation is intended for authorized service technicians only.**

5. Press and hold the power button for 20 seconds to drain the flea power.
6. Install the battery.
7. Install the base cover.
8. Connect the power adapter to your computer.
9. Turn on your computer.





**NOTE:** For more information about performing a hard reset, search in the Knowledge Base Resource at [www.dell.com/support](http://www.dell.com/support).

# Getting help and contacting Dell

## Self-help resources

You can get information and help on Dell products and services using these self-help resources:

**Table 47. Self-help resources**

Self-help resources	Resource location
Information about Dell products and services	<a href="http://www.dell.com">www.dell.com</a>
My Dell app	
Tips	
Contact Support	In Windows search, type <code>Contact Support</code> , and press Enter.
Online help for operating system	<a href="http://www.dell.com/support/windows">www.dell.com/support/windows</a> <a href="http://www.dell.com/support/linux">www.dell.com/support/linux</a>
Access top solutions, diagnostics, drivers and downloads, and learn more about your computer through videos, manuals, and documents.	Your Dell computer is uniquely identified using a Service Tag or Express Service Code. To view relevant support resources for your Dell computer, enter the Service Tag or Express Service Code at <a href="http://www.dell.com/support">www.dell.com/support</a> .  For more information about how to find the Service Tag for your computer, see <a href="#">Locate the Service Tag on your computer</a> .
Dell knowledge base articles	<ol style="list-style-type: none"> <li>1. Go to <a href="http://www.dell.com/support">www.dell.com/support</a>.</li> <li>2. On the menu bar at the top of the Support page, select <b>Support &gt; Support Library</b>.</li> <li>3. In the Search field on the Support Library page, type the keyword, topic, or model number, and then click or tap the search icon to view the related articles.</li> </ol>

## Contacting Dell

To contact Dell for sales, technical support, or customer service issues, see [www.dell.com/contactdell](http://www.dell.com/contactdell).

 **NOTE:** Availability of the services may vary depending on the country or region, and product.

 **NOTE:** If you do not have an active Internet connection, you can find contact information about your purchase invoice, packing slip, bill, or Dell product catalog.