

OptiPlex Tower 7010

Owner's Manual

Notes, cautions, and warnings

 **NOTE:** A NOTE indicates important information that helps you make better use of your product.

 **CAUTION:** A CAUTION indicates either potential damage to hardware or loss of data and tells you how to avoid the problem.

 **WARNING:** A WARNING indicates a potential for property damage, personal injury, or death.

Contents

Chapter 1: Views of OptiPlex Tower 7010	7
Front.....	8
Back.....	10
Chapter 2: Set up your computer	12
Chapter 3: Specifications of OptiPlex Tower 7010	18
Dimensions and weight.....	18
Processor.....	18
Chipset.....	20
Operating system.....	20
Memory.....	20
Memory matrix.....	21
External ports.....	21
Internal slots.....	22
Ethernet.....	22
Wireless module.....	23
Audio.....	23
Storage.....	24
Power ratings.....	25
Power supply connector.....	25
GPU—Integrated.....	26
GPU—Discrete.....	26
Video port resolution.....	26
Hardware security.....	27
Environmental.....	27
Regulatory compliance.....	28
Operating and storage environment.....	28
Chapter 4: Working inside your computer	29
Safety instructions.....	29
Before working inside your computer.....	29
Safety precautions.....	30
Electrostatic discharge—ESD protection.....	30
ESD field service kit	31
Transporting sensitive components.....	32
After working inside your computer.....	32
BitLocker.....	32
Recommended tools.....	32
Screw list.....	33
Major components of OptiPlex Tower 7010.....	34
Chapter 5:	36
Removing the side cover.....	36

Installing the side cover.....	38
Chapter 6: Removing and installing Customer Replaceable Units (CRUs).....	40
Front bezel	40
Removing the front bezel.....	40
Installing the front bezel.....	41
Hard drive.....	42
2.5-inch hard drive.....	42
3.5-inch hard drive.....	47
Optical drive.....	49
Removing the optical drive.....	49
Installing the optical drive.....	50
Memory.....	51
Removing the memory.....	51
Installing the memory.....	52
Solid-state drives.....	53
Solid-state drive (half-length).....	53
Solid-state drive (full-length).....	55
Wireless card.....	57
Removing the wireless card.....	57
Installing the wireless card.....	58
Expansion card.....	60
Removing the graphics card.....	60
Installing the graphics card.....	61
Internal speaker.....	62
Removing the speaker.....	62
Installing the speaker.....	62
Coin-cell battery.....	63
Removing the coin-cell battery.....	63
Installing the coin-cell battery.....	64
Chapter 7: Removing and installing Field Replaceable Units (FRUs).....	66
Intrusion switch.....	66
Removing the intrusion switch.....	66
Installing the intrusion switch.....	67
Power-supply unit.....	68
Removing the power-supply unit.....	68
Installing the power-supply unit	70
Fan duct.....	72
Removing the fan duct.....	72
Installing the fan duct.....	73
Processor fan and heat-sink assembly.....	75
Removing the processor fan and heat-sink assembly.....	75
Installing the processor fan and heat-sink assembly.....	76
Processor.....	77
Removing the processor.....	77
Installing the processor.....	77
Front Input/Output bracket.....	78
Removing the front Input/Output bracket.....	78

Installing the front input/output bracket.....	79
Power button.....	80
Removing the power button.....	80
Installing the power button.....	81
Wireless antenna kit.....	82
Internal antenna kit.....	82
External SMA antenna kit.....	86
Optional Input/Output modules.....	90
Serial module.....	90
VGA module.....	91
DP module.....	93
HDMI module.....	95
System board.....	97
Removing the system board.....	97
Installing the system board.....	102
Chapter 8: Software.....	108
Operating system.....	108
Drivers and downloads.....	108
Chapter 9: BIOS setup.....	109
Entering BIOS setup program.....	109
Navigation keys.....	109
One Time Boot menu.....	109
System setup options.....	110
Updating the BIOS.....	124
Updating the BIOS in Windows.....	124
Updating the BIOS in Linux and Ubuntu.....	124
Updating the BIOS using the USB drive in Windows.....	124
Updating the BIOS from the F12 One-Time boot menu.....	125
Updating the BIOS.....	125
Updating the BIOS in Windows.....	125
Updating the BIOS using the USB drive in Windows.....	126
Updating the BIOS in Linux and Ubuntu.....	126
Updating the BIOS from the F12 One Time Boot menu.....	126
System and setup password.....	127
Assigning a system setup password.....	127
Deleting or changing an existing system setup password.....	128
Clearing CMOS settings.....	128
Clearing BIOS (System Setup) and System passwords.....	128
Chapter 10: Troubleshooting.....	129
Dell SupportAssist Pre-boot System Performance Check diagnostics.....	129
Running the SupportAssist Pre-Boot System Performance Check.....	129
Power-Supply Unit Built-in Self-Test	129
System-diagnostic lights.....	130
Recovering the operating system.....	131
Real Time Clock—RTC reset.....	131
Backup media and recovery options.....	132

Wi-Fi power cycle..... 132

Chapter 11: Getting help and contacting Dell..... 133

Views of OptiPlex Tower 7010

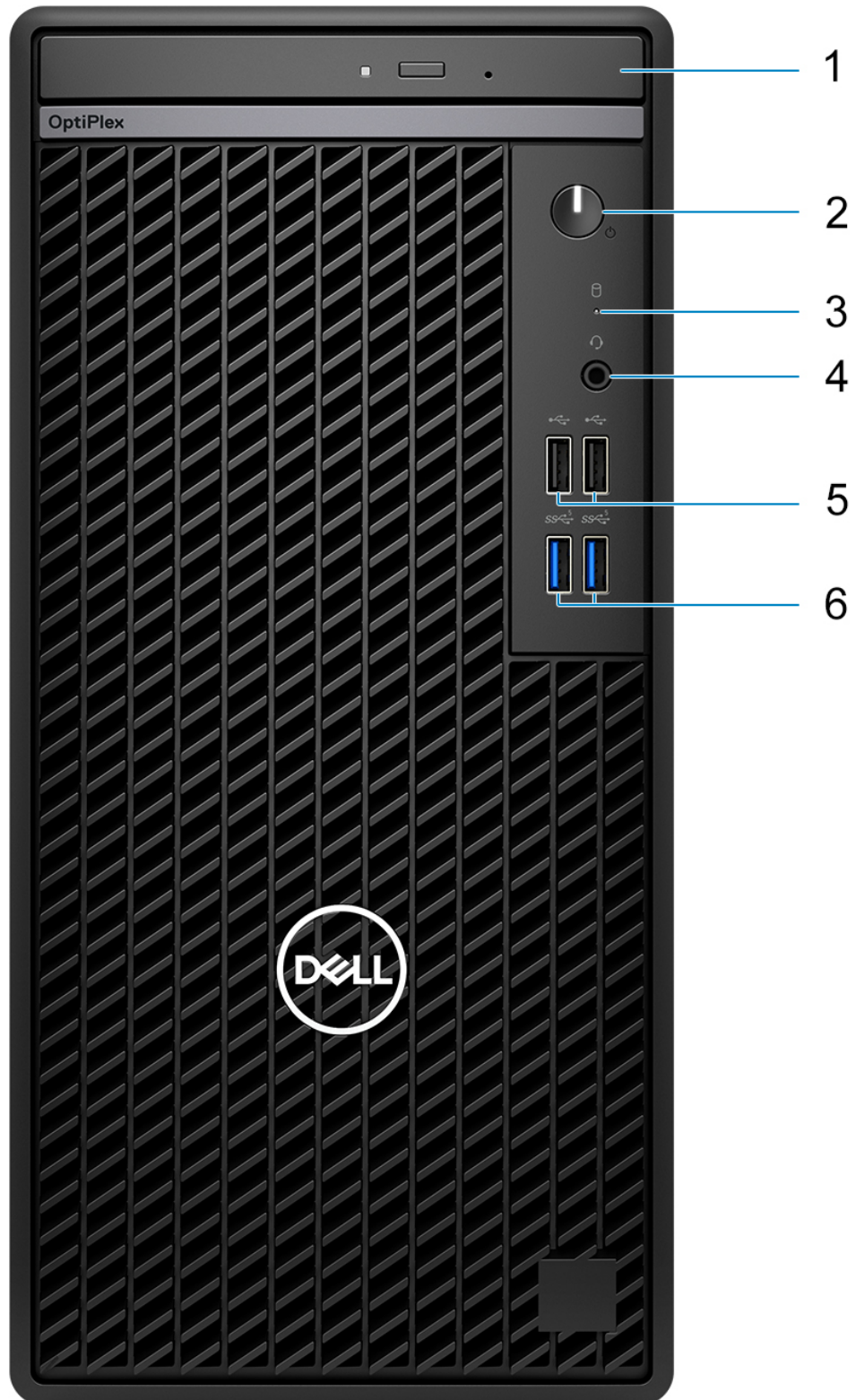

Front

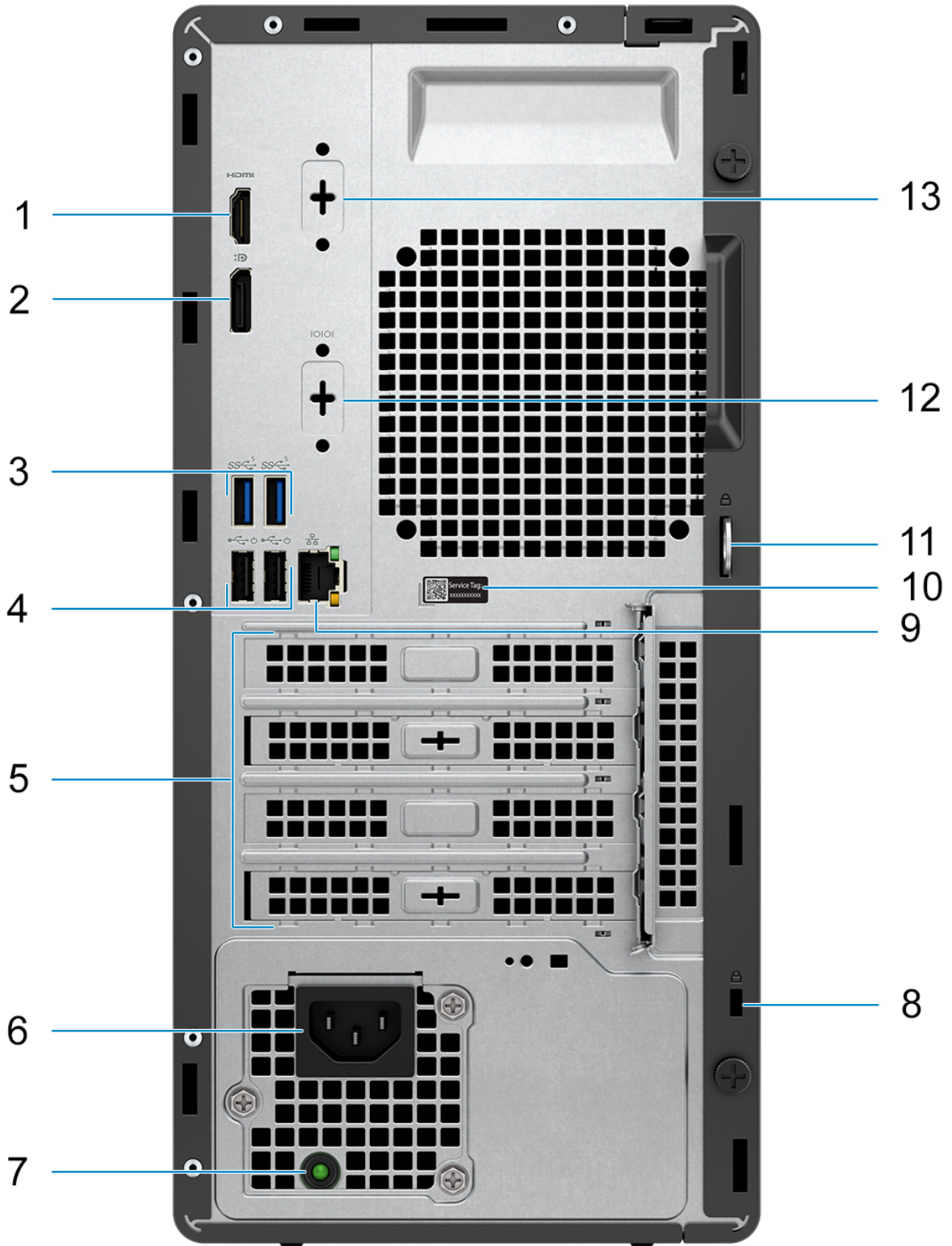

1. Optical disk-drive (optional)
2. Power button with diagnostic LED
3. Hard-drive activity light
4. Universal audio jack port
5. Two USB 2.0 (480 Mbps) ports
6. Two USB 3.2 Gen 1 (5 Gbps) ports

Back



1. HDMI 1.4b port
 -  **NOTE:** Maximum resolution up to 1920 x 1200 @60Hz
2. DisplayPort 1.4a port (HBR2)
 -  **NOTE:** Maximum resolution up to 4096 x 2304 @60Hz
3. Two USB 3.2 Gen 1 (5 Gbps) ports
4. Two USB 2.0 (480 Mbps) ports with Smart Power On
5. Three expansion card slots
6. Power cord connector port
7. Power supply diagnostic light
8. Security-cable slot (for Kensington locks)
9. RJ45 Ethernet port (10/100/1000 Mbps)
10. Service tag label
11. Padlock ring
12. Serial port (optional)
13. One video port (DisplayPort 1.4a (HBR3)/HDMI 2.1/VGA) (optional)
 -  **NOTE:** Maximum resolution
 - **HDMI 2.1:** up to 4096 x 2160 @60Hz
 - **DisplayPort 1.4a (HBR3):** up to 5120 x 3200 @60Hz
 - **VGA:** up to 1920 x 1200 @60Hz

Set up your computer

Steps

1. Connect the keyboard and mouse.

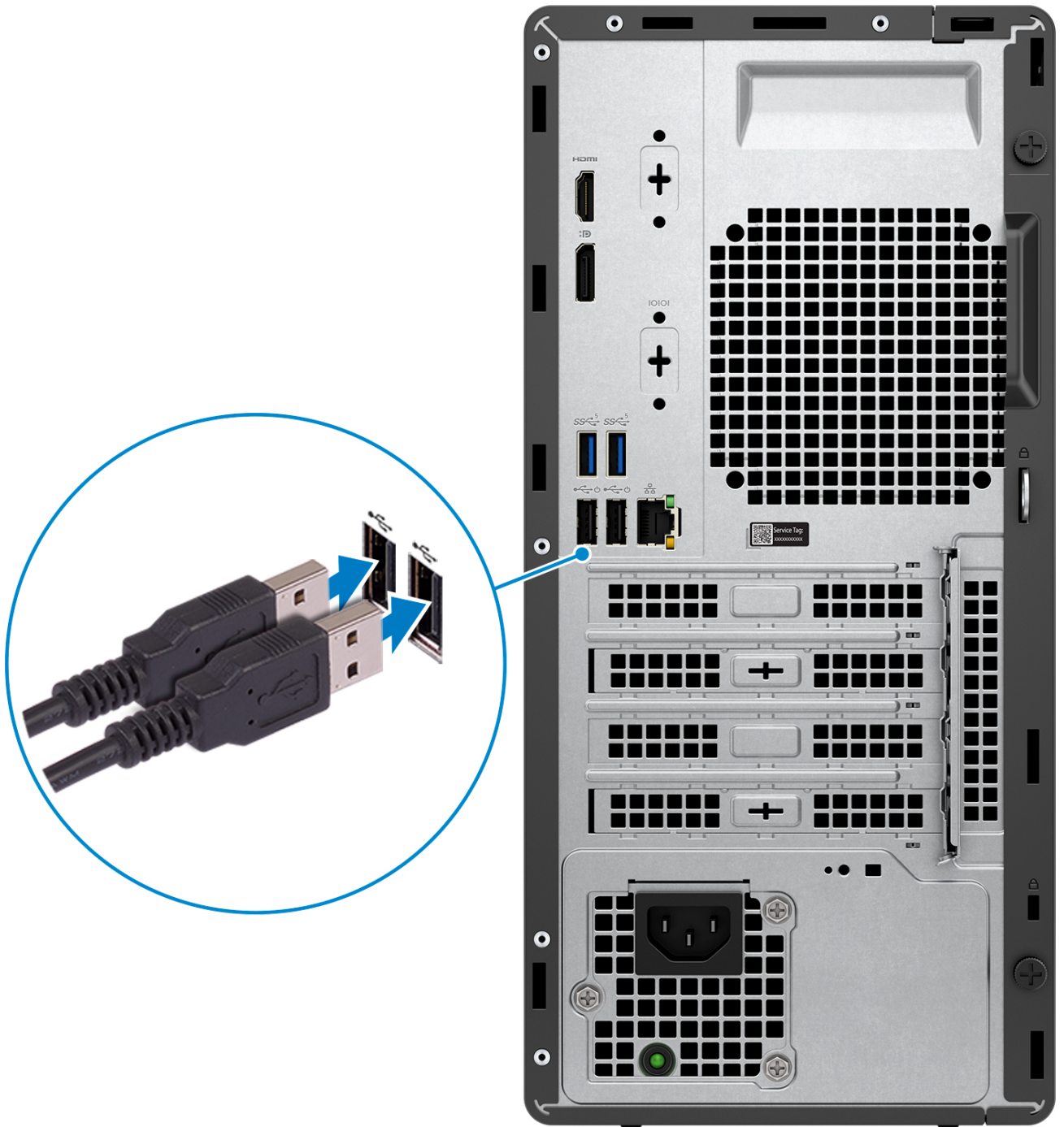

2. Connect to your network using a cable.

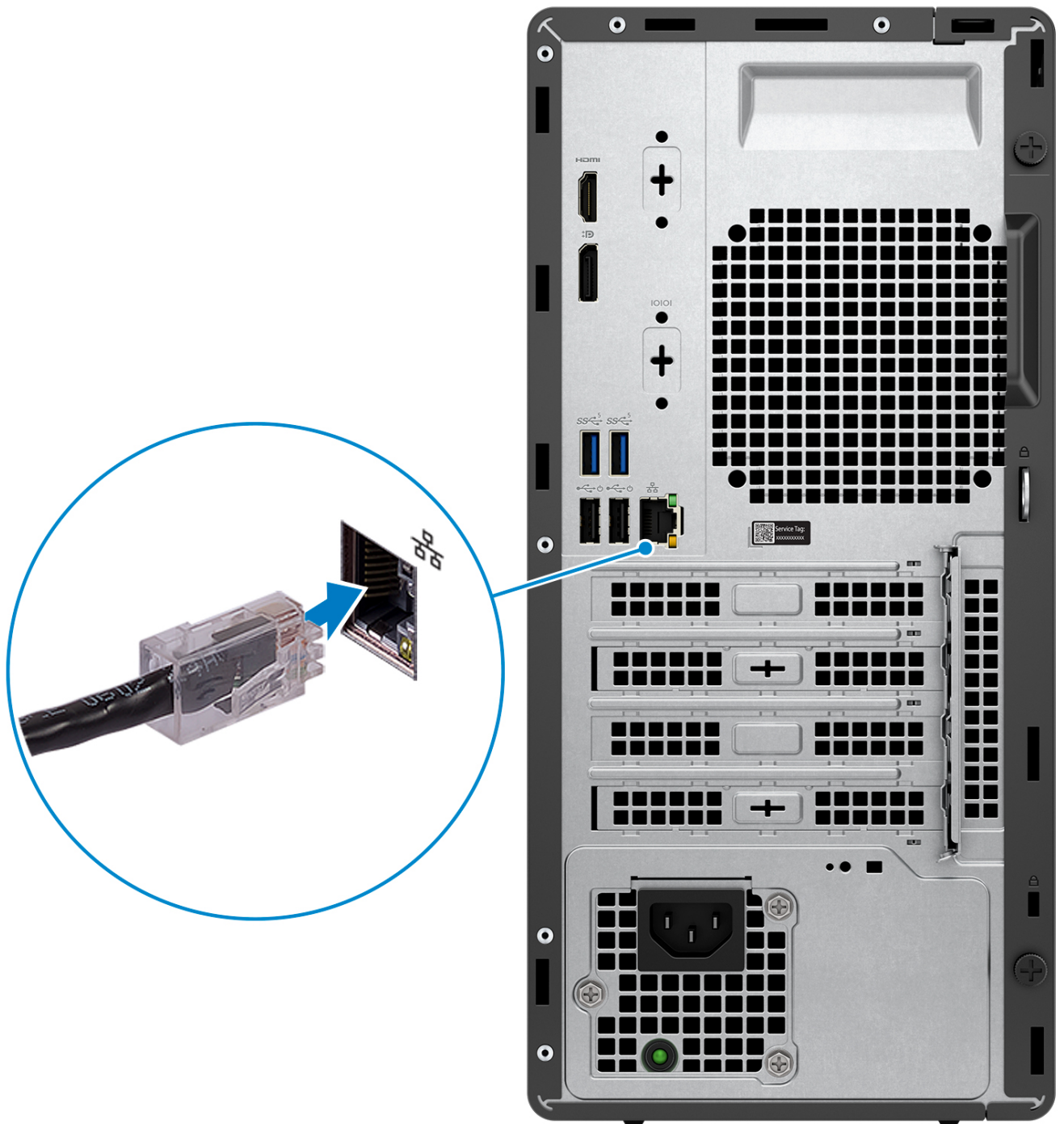

i **NOTE:** Alternatively, you can connect to a wireless network.

3. Connect the display.



NOTE: If you ordered your computer with a discrete graphics card, the HDMI and the display ports on the back panel of your computer are covered. Connect the display to the port on the discrete graphics card.

4. Connect the power cable.

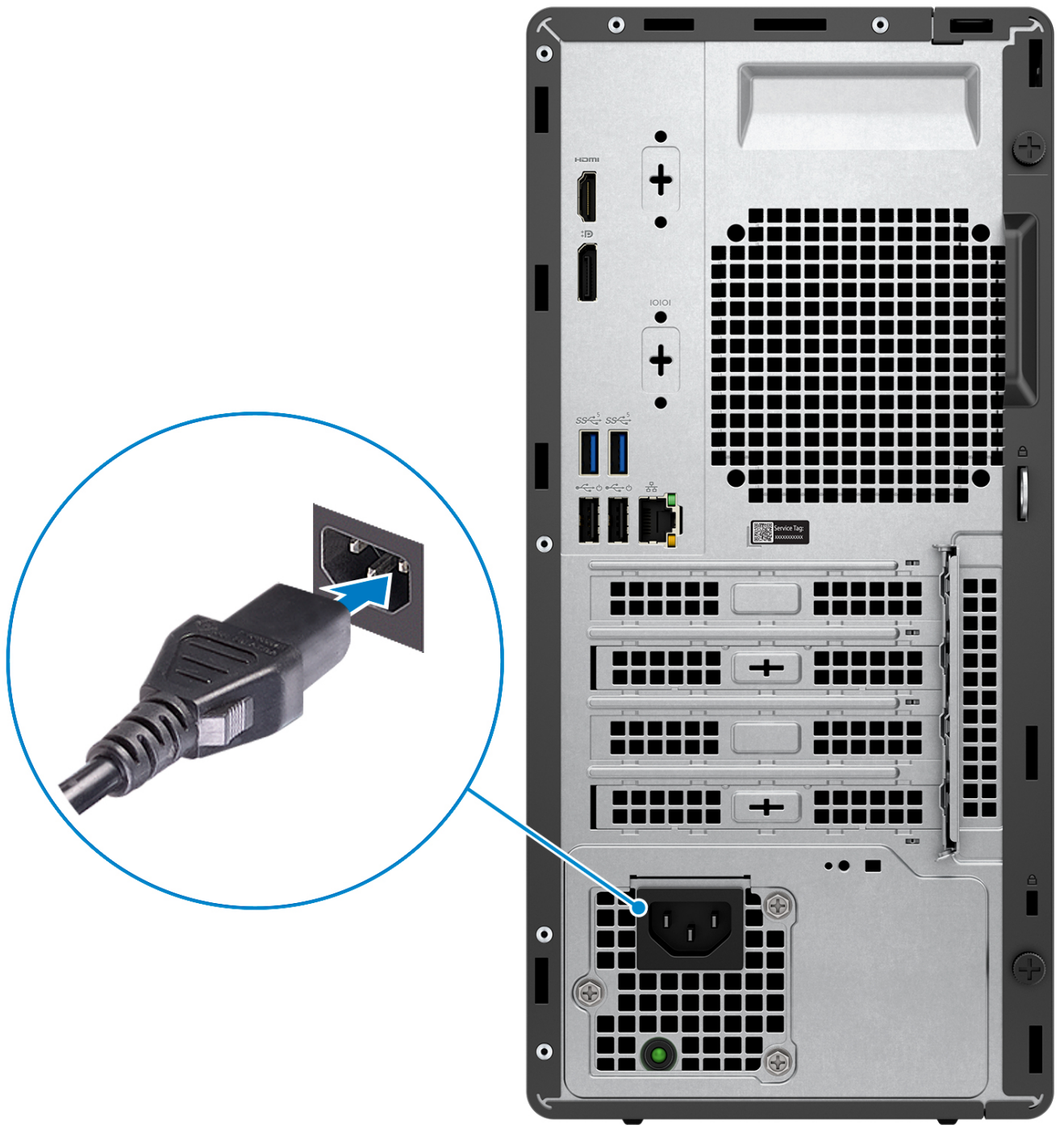

5. Press the power button.



6. Finish the Windows setup.





Follow the on-screen instructions to complete the setup. When setting up, Dell recommends that you:

- Connect to a network for Windows updates.
 - **NOTE:** If connecting to a secured wireless network, enter the password for the wireless network access when prompted.
- If connected to the internet, sign-in with or create a Microsoft account.

- On the **Support and Protection** screen, enter your contact details.

7. Locate and use Dell apps from the Windows Start menu—Recommended

Table 1. Locate Dell apps

Resources	Description
	<p>MyDell</p> <p>MyDell is a software application that offers you a single streamlined engagement platform including account access, device information, and hardware settings. This software delivers intelligent features that automatically fine-tune your computer for the best possible audio, power, and performance. Get the most out of your Dell device with intelligent, personalized technology from MyDell. Following are the key features of MyDell:</p> <ul style="list-style-type: none"> • Application • Audio • Power • Color and Display • Presence detection <p>For more information about how to use MyDell, see product guides at www.dell.com/support.</p>
	<p>SupportAssist</p> <p>SupportAssist proactively and predictively identifies hardware and software issues on your computer and automates the engagement process with Dell Technical support. It addresses performance and stabilization issues, prevents security threats, monitors, and detects hardware failures. For more information, see <i>SupportAssist for Home PCs User's Guide</i> at www.dell.com/support/home/product-support/product/dell-supportassist-pcs-tablets/docs.</p> <p>NOTE: In SupportAssist, click the warranty expiry date to renew or upgrade your warranty.</p>
	<p>Dell Update</p> <p>Updates your computer with critical fixes and latest device drivers as they become available. For more information about using Dell Update, see the product guides and third-party license documents at www.dell.com/support.</p>
	<p>Dell Digital Delivery</p> <p>Download software applications, which are purchased but not preinstalled on your computer. For more information about using Dell Digital Delivery, search in the Knowledge Base Resource at www.dell.com/support.</p>

Specifications of OptiPlex Tower 7010

Dimensions and weight

The following table lists the height, width, depth, and weight of your OptiPlex Tower 7010.

Table 2. Dimensions and weight

Description	Values
Height	324.30 mm (12.77 in.)
Width	154.00 mm (6.06 in.)
Depth	292.20 mm (11.50 in.)
Weight  NOTE: The weight of your computer depends on the configuration ordered and manufacturing variability.	<ul style="list-style-type: none"> • Minimum - 5.32 kg (11.72 lb) • Maximum - 6.52 kg (14.38 lb)

Processor

The following table lists the details of the processors supported by your OptiPlex Tower 7010.

Table 3. Processor

Description	Option one	Option two	Option three	Option four	Option five	Option six
Processor type	13 th Generation Intel Core i3-13100	13 th Generation Intel Core i5-13400	13 th Generation Intel Core i5-13500	13 th Generation Intel Core i5-13600	Intel Celeron G 6900	Intel Pentium G 7400
Processor wattage	60 W	65 W	65 W	65 W	46 W	46 W
Processor total core count	4	10	14	14	2	2
Performance-cores	4	6	6	6	2	2
Efficient-cores	0	4	8	8	0	0
Processor total thread counts	8	16	20	20	2	4
 NOTE: Intel® Hyper-Threading Technology is only available on Performance-cores.						
Processor speed	3.40 GHz to 4.50 GHz	2.50 GHz to 4.60 GHz	2.50 GHz to 4.80 GHz	2.70 GHz to 5.00 GHz	up to 3.40 GHz	up to 3.70 GHz
Performance-cores frequency						
Processor base frequency	3.40 Ghz	2.50 Ghz	2.50 Ghz	2.70 Ghz	3.40 Ghz	3.70 Ghz
Maximum turbo frequency	4.50 Ghz	4.60 Ghz	4.80 Ghz	5.00 Ghz	NA	NA
Efficient-cores frequency						
Processor base frequency	NA	1.80 Ghz	1.80 Ghz	2.00 Ghz	NA	NA
Maximum turbo frequency	NA	3.30 Ghz	3.50 Ghz	3.70 Ghz	NA	NA
Processor cache	12 MB	20 MB	24 MB	24 MB	4 MB	6 MB
Integrated graphics	Intel UHD Graphics 730	Intel UHD Graphics 730	Intel UHD Graphics 770	Intel UHD Graphics 770	Intel UHD Graphics 710	Intel UHD Graphics 710

Chipset

The following table lists the details of the chipset supported by your OptiPlex Tower 7010.

Table 4. Chipset

Description	Values
Chipset	Intel Q670
Processor	<ul style="list-style-type: none">● 13th Generation Intel Core i3/i5● Intel Pentium Gold● Intel Celeron
DRAM bus width	64-bit
Flash EPROM	32MB RPMC+16MB nRPMC
PCIe bus	Upto Gen3

Operating system

Your OptiPlex Tower 7010 supports the following operating systems:

- Windows 11 Home
- Windows 11 Pro
- Windows 11 Pro Downgrade (Windows 10 image)
- Windows 11 Pro National Education
- Windows 10 CMIT Government Edition, (China only)
- Ubuntu Linux 22.04 LTS

Memory

The following table lists the memory specifications of your OptiPlex Tower 7010.

Table 5. Memory specifications

Description	Values
Memory slots	Two-UDIMM slots
Memory type	DDR4
Memory speed	<ul style="list-style-type: none">● 3200 MT/s
Maximum memory configuration	64 GB
Minimum memory configuration	4GB
Memory size per slot	4 GB, 8 GB, 16 GB, and 32 GB
Memory configurations supported	<ul style="list-style-type: none">● 4 GB, 1 x 4 GB, DDR4, 3200 MT/s, single-channel● 8 GB, 1 x 8 GB, DDR4, 3200 MT/s, single-channel● 8 GB, 2 x 4 GB, DDR4, 3200 MT/s, dual-channel● 16 GB, 1 x 16 GB, DDR4, 3200 MT/s, single-channel● 16 GB, 2 x 8 GB, DDR4, 3200 MT/s, dual-channel● 32 GB, 1 x 32 GB, DDR4, 3200 MT/s, single-channel

Table 5. Memory specifications (continued)

Description	Values
	<ul style="list-style-type: none">• 32 GB, 2 x 16 GB, DDR4, 3200 MT/s, dual-channel• 64 GB, 2 x 32 GB, DDR4, 3200 MT/s, dual-channel

Memory matrix

The following table lists the memory configurations supported on your OptiPlex Tower 7010.

Table 6. Memory matrix

Configuration	Slot	
	UDIMM1	UDIMM2
4 GB DDR4	4 GB	NA
8 GB DDR4	8 GB	NA
8 GB DDR4	4 GB	4 GB
16 GB DDR4	16 GB	NA
16 GB DDR4	8 GB	8 GB
32 GB DDR4	32 GB	NA
32 GB DDR4	16 GB	16 GB
64 GB DDR4	32 GB	32 GB

External ports

The following table lists the external ports of your OptiPlex Tower 7010.

Table 7. External ports

Description	Values
Network port	<ul style="list-style-type: none">• One RJ45 Ethernet port, 1 GHz• One RJ45 Ethernet port, 2.5 GHz (optional)
USB ports	Front: <ul style="list-style-type: none">• Two USB 2.0 (480 Mbps) ports• Two USB 3.2 Gen 1 (5 Gbps) ports Rear: <ul style="list-style-type: none">• Two USB 2.0 (480 Mbps) ports with Smart Power On• Two USB 3.2 Gen 1 (5 Gbps) ports
Audio port	Universal audio jack port
Video port	<ul style="list-style-type: none">• One DisplayPort 1.4a (HBR2) i NOTE: Maximum resolution up to 4096 x 2304 @60Hz• One HDMI 1.4b port i NOTE: Maximum resolution up to 1920 x 1200 @60Hz• One Optional video port (/Displayport 1.4a port (HBR3)/ HDMI 2.1/VGA) i NOTE: Maximum resolution<ul style="list-style-type: none">◦ HDMI 2.1: up to 4096 x 2160 @60Hz

Table 7. External ports (continued)

Description	Values
	<ul style="list-style-type: none"> ○ DisplayPort 1.4a (HBR3): up to 5120 x 3200 @60Hz ○ VGA: up to 1920 x 1200 @60Hz <p>NOTE: Download and install the latest Intel Graphics driver from www.dell.com/support to enable multiple displays.</p>
I/O port	One Serial port (optional)
Media-card reader	NA
Power-adaptor port	NA
Security-cable slot	One security-cable slot (for Kensington locks)

Internal slots

The following table lists the internal slots of your OptiPlex Tower 7010.

Table 8. Internal slots

Description	Values
Expansion	<ul style="list-style-type: none"> ● 1 Full-height Gen 3 PCIe x16 slot ● 2 Full-height Gen 3 PCIe x1 slot
SATA	<ul style="list-style-type: none"> ● 3 SATA slots for 2.5-inch/3.5-inch hard-drive and slim optical drive
M.2	<ul style="list-style-type: none"> ● One M.2 2230 slot for WiFi and Bluetooth card ● One M.2 2230/2280 slots for solid-state drives <p>NOTE: To learn more about the features of different types of M.2 cards, search in the Knowledge Base Resource at www.dell.com/support.</p>

Ethernet

The following table lists the wired Ethernet Local Area Network (LAN) specifications of your OptiPlex Tower 7010.

Table 9. Ethernet specifications

Description	Values
Model number	Realtek 8111HD
Transfer rate	10/100/1000 Mbps

Wireless module

The following table lists the Wireless Local Area Network (WLAN) module specifications of your OptiPlex Tower 7010.

Table 10. Wireless module specifications

Description	Option one	Option two	Option three
Model number	Intel AX211 i NOTE: Intel AX211 is always tied with External SMA antenna	Realtek RTL8852BE	Realtek RTL8821CE
Transfer rate	2400 Mbps	1201 Mbps	Up to 433 Mbps
Frequency bands supported	2.40 GHz/5 GHz/6 GHz i NOTE: The 6 GHz frequency is supported on computers installed with Windows 11 operating system only.	2.40 GHz/5 GHz	2.4 GHz/5 GHz
Wireless standards	<ul style="list-style-type: none"> • WiFi 802.11a /b/g • Wi-Fi 4 (WiFi 802.11n) • Wi-Fi 5 (WiFi 802.11ac) • Wi-Fi 6E (WiFi 802.11ax) 	<ul style="list-style-type: none"> • WiFi 802.11a /b/g • Wi-Fi 4 (WiFi 802.11n) • Wi-Fi 5 (WiFi 802.11ac) • Wi-Fi 6 (WiFi 802.11ax) 	<ul style="list-style-type: none"> • WiFi 802.11a /b/g • Wi-Fi 4 (WiFi 802.11n) • Wi-Fi 5 (WiFi 802.11ac)
Encryption	<ul style="list-style-type: none"> • 64-bit/128-bit WEP • AES-CCMP • TKIP 	<ul style="list-style-type: none"> • 64-bit/128-bit WEP • AES-CCMP • TKIP 	<ul style="list-style-type: none"> • 64-bit/128-bit WEP • AES-CCMP • TKIP
Bluetooth wireless card	Bluetooth wireless card	Bluetooth wireless card	Bluetooth wireless card
	i NOTE: The version of the Bluetooth wireless card may vary depending on the operating system that is installed on your computer.		

Audio

The following table lists the audio specifications of your OptiPlex Tower 7010.

Table 11. Audio specifications

Description	Values
Audio controller	Realtek ALC3246-CG
Stereo conversion	24-bit DAC (Digital-to-Analog) and ADC (Analog-to-Digital)
Internal audio interface	Intel HDA (high-definition audio)
External audio interface	<ul style="list-style-type: none"> • Universal audio jack • One Line-out audio port with re-tasking to Line-in (rear)
Number of speakers	One
Internal-speaker amplifier	Codec built-in amp
External volume controls	Not supported

Table 11. Audio specifications (continued)

Description		Values
Speaker output:		
	Average speaker output	2 W
	Peak speaker output	2.5 W
Subwoofer output		Not supported
Microphone		Supported via Universal audio jack

Storage

This section lists the storage options on your OptiPlex Tower 7010.

Table 12. Storage Matrix

Storage	1st 2.5-inch hard drive	2nd 2.5-inch hard drive	Single 3.5-inch hard drive	Single M.2 socket
2.5-inch hard-drive	Yes	No	No	No
Dual 2.5-inch hard-drive	Yes	Yes	No	No
3.5-inch hard-drive	No	No	Yes	No
2.5-inch hard-drive + 3.5-inch hard-drive	Yes	No	Yes	No
3.5-inch hard-drive + 2.5-inch hard-drive	No	Yes	Yes	No
M.2 solid-state drive + 3.5-inch hard-drive	No	No	Yes	Yes
M.2 solid-state drive + 2.5-inch hard-drive	No	Yes	No	Yes
M.2 solid-state drive + Dual 2.5-inch hard-drive	Yes	Yes	No	Yes
M.2 16 GB/32 GB + 2.5-inch hard-drive	Yes	No	No	Yes
M.2 16 GB/32 GB + Dual 2.5-inch hard-drive	Yes	Yes	No	Yes
M.2 16 GB/32 GB + 3.5-inch hard-drive	No	No	Yes	Yes
M.2 16 GB/32 GB + 2.5-inch hard-drive + 3.5-inch hard-drive	Yes	No	Yes	Yes
M.2 16 GB/32 GB + 3.5-inch hard-drive + 2.5-inch hard-drive	No	Yes	Yes	Yes
M.2 solid-state drive	No	No	No	Yes

Table 13. Storage specifications

Storage type	Interface type	Capacity
2.5-inch, 7200 RPM, hard-disk drive	SATA 3.0	Up to 1 TB
3.5-inch, 7200 RPM, hard-disk drive	SATA 3.0	Up to 2 TB
M.2 2230 solid-state drive	PCIe NVMe, Class 25	Up to 2 TB
M.2 2230 solid-state drive	PCIe NVMe, Class 35	Up to 1 TB
M.2 2230 Opal Self-Encrypting solid-state drive	PCIe NVMe, Class 35	256 GB
M.2 2280 solid-state drive	PCIe NVMe, Class 40	Up to 1 TB

Table 13. Storage specifications (continued)

Storage type	Interface type	Capacity
M.2 2280 Opal Self-Encrypting solid-state drive	PCIe NVMe, Class 40	Up to 1 TB

Power ratings

The following table lists the power rating specifications of OptiPlex Tower 7010.

Table 14. Power ratings

Description	Option one	Option two
Type	180 W internal power supply unit (PSU), 85% Efficient, 80 Plus Bronze	300 W internal power supply unit (PSU), 92% Efficient, 80 Plus Platinum
Input voltage	90 VAC–264 VAC	90 VAC–264 VAC
Input frequency	47 Hz–63 Hz	47 Hz–63 Hz
Input current (maximum)	3.0 A	4.2 A
Output current (continuous)	<ul style="list-style-type: none"> ● 12 VA/15 A ● 12 VB/14 A Standby mode: <ul style="list-style-type: none"> ● 12 VA/1.5 A ● 12 VB/3.3 A 	<ul style="list-style-type: none"> ● 12 VA/18 A ● 12 VB/18 A Standby mode: <ul style="list-style-type: none"> ● 12 VA/1.5 A ● 12 VB/3.3 A
Rated output voltage	<ul style="list-style-type: none"> ● +12 VA ● +12 VB 	<ul style="list-style-type: none"> ● +12 VA ● +12 VB
Temperature range:		
Operating	5°C–45°C (41°F–113°F)	5°C–45°C (41°F–113°F)
Storage	-40°C–70°C (-40°F–158°F)	-40°C–70°C (-40°F–158°F)

Power supply connector

The following table lists the Power supply connector specifications of your OptiPlex Tower 7010.

Table 15. Power supply connector

Power supply unit	Power supply connectors
180 W (80 PLUS Bronze)	<ul style="list-style-type: none"> ● Two 4 pin connectors for processor ● One 8 pin connector for system board
300 W (80 PLUS Platinum)	<ul style="list-style-type: none"> ● Two 4 pin connectors for processor ● One 8 pin connector for system board

GPU—Integrated

The following table lists the specifications of the integrated Graphics Processing Unit (GPU) supported by your OptiPlex Tower 7010.

Table 16. GPU—Integrated

Controller	External display support	Memory size	Processor
Intel UHD Graphics 710	<ul style="list-style-type: none"> One DisplayPort 1.4a port (HBR2) One HDMI 1.4b port (1920x1200@60Hz max. resolution) 	Shared system memory	Intel Pentium G7400/ Intel Celeron G6900 processors
Intel UHD Graphics 730	<ul style="list-style-type: none"> One DisplayPort 1.4a port (HBR2) One HDMI 1.4b port (1920x1200@60Hz max. resolution) 	Shared system memory	13 th Generation Intel Core i5-13400/ 13100 processors
Intel UHD Graphics 770	<ul style="list-style-type: none"> One DisplayPort 1.4a port (HBR2) One HDMI 1.4b port (1920x1200@60Hz max. resolution) 	TBD	13 th Generation Intel Core i5-13600/ 13600 processors

GPU—Discrete

The following table lists the specifications of the discrete Graphics Processing Unit (GPU) supported by your OptiPlex Tower 7010.

Table 17. GPU—Discrete

Controller	External display support	Memory size	Memory type
AMD Radeon RX6300	Two DisplayPort 1.4 ports	2 GB	GDDR6
AMD Radeon RX6500	Two DisplayPort 1.4 ports	4 GB	GDDR6

Video port resolution

The following table lists the video port resolution for your OptiPlex Tower 7010.

Table 18. Video port resolution

Graphics card	Video ports	Maximum supported resolution
AMD Radeon RX6300	<ul style="list-style-type: none"> 2 DisplayPort 1.4a ports 	<ul style="list-style-type: none"> 8K 120 Hz, 8K @60 Hz is the maximum resolution for one port configuration.
AMD Radeon RX6300	<ul style="list-style-type: none"> 2 DisplayPort 1.4a ports 	<ul style="list-style-type: none"> 8K 120 Hz, 8K @60 Hz is the maximum resolution for one port configuration.

Hardware security

The following table lists the hardware security of your OptiPlex Tower 7010.

Table 19. Hardware security

Hardware security
Kensington security-cable slot
Padlock ring
Chassis lock slot support
Chassis intrusion switch
Lockable cable covers
Supply chain tamper alerts
SafelD including Trusted Platform Module (TPM) 2.0
Smart card keyboard (FIPS)
Microsoft Windows Device Guard and Credential Guard (Enterprise SKU)
Microsoft Windows Bitlocker
Local hard drive data wipe through BIOS (Secure Erase)
Self-encrypting storage drives (Opal, FIPS)
Trusted Platform Module TPM 2.0
China TPM
Intel Secure Boot
Intel Authenticate
SafeBIOS: includes Dell Off-host BIOS Verification, BIOS Resilience, BIOS Recovery, and additional BIOS Controls

Environmental

The following table lists the environmental specifications of your OptiPlex Tower 7010.

Table 20. Environmental

Feature	Values
Recyclable packaging	Yes
BFR/PVC—free	No
Vertical orientation packaging support	No
Multi-Pack packaging	Yes (optional)
Energy-Efficient Power Supply	Standard
ENV0424 compliant	Yes

NOTE: Wood-based fiber packaging contains a minimum of 35% recycled content by total weight of wood-based fiber. Packaging that contains without wood-based fiber can be claimed as Not Applicable. The anticipated required criteria for EPEAT 2018.

Regulatory compliance

The following table lists the regulatory compliance of your OptiPlex Tower 7010.

Table 21. Regulatory compliance

Regulatory compliance
Product Safety, EMC and Environmental Datasheets
Dell Regulatory Compliance Home page
Dell and the Environment

Operating and storage environment

This table lists the operating and storage specifications of your OptiPlex Tower 7010.

Airborne contaminant level: G1 as defined by ISA-S71.04-1985

Table 22. Computer environment

Description	Operating	Storage
Temperature range	10°C-35°C (50°F-95°F)	-40°C-70°C (-40°F-158°F)
Relative humidity (maximum)	20% to 80% (non-condensing) (non-condensing, Max dew point temperature = 26°C)	0% to 95% (non-condensing) 5% to 95% (non-condensing, Max dew point temperature = 33°C)
Vibration (maximum)*	0.26 GRMS random at 5 Hz-350 Hz	1.37 GRMS random at 5 Hz-350 Hz
Shock (maximum)	Bottom/Right half-sine pulse 40G, 2 ms	105G, 2 ms half-sine pulse
Altitude range	-15.2 m to 3048 m (-49.8 ft to 10,000 ft)	-15.2 m to 10,668 m (-49.8 ft to 35,000 ft)
CAUTION: Operating and storage temperature ranges may differ among components, so operating or storing the device outside these ranges may impact the performance of specific components.		











* Measured using a random vibration spectrum that simulates user environment.

† Measured using a 2 ms half-sine pulse.

Working inside your computer

Safety instructions

Use the following safety guidelines to protect your computer from potential damage and to ensure your personal safety. Unless otherwise noted, each procedure included in this document assumes that you have read the safety information that shipped with your computer.

-  **WARNING:** Before working inside your computer, read the safety information that is shipped with your computer. For more safety best practices, see the Regulatory Compliance home page at www.dell.com/regulatory_compliance.
-  **WARNING:** Disconnect your computer from all power sources before opening the computer cover or panels. After you finish working inside the computer, replace all covers, panels, and screws before connecting your computer to an electrical outlet.
-  **CAUTION:** To avoid damaging the computer, ensure that the work surface is flat, dry, and clean.
-  **CAUTION:** To avoid damaging the components and cards, handle them by their edges, and avoid touching the pins and the contacts.
-  **CAUTION:** You should only perform troubleshooting and repairs as authorized or directed by the Dell technical assistance team. Damage due to servicing that is not authorized by Dell is not covered by your warranty. See the safety instructions that is shipped with the product or at www.dell.com/regulatory_compliance.
-  **CAUTION:** Before touching anything inside your computer, ground yourself by touching an unpainted metal surface, such as the metal at the back of the computer. While you work, periodically touch an unpainted metal surface to dissipate static electricity which could harm internal components.
-  **CAUTION:** When you disconnect a cable, pull it by its connector or its pull tab, not the cable itself. Some cables have connectors with locking tabs or thumbscrews that you must disengage before disconnecting the cable. When disconnecting cables, keep them evenly aligned to avoid bending the connector pins. When connecting cables, ensure that the ports and the connectors are correctly oriented and aligned.
-  **CAUTION:** Press and eject any installed card from the media-card reader.
-  **CAUTION:** Exercise caution when handling rechargeable Li-ion batteries in laptops. Swollen batteries should not be used and should be replaced and disposed properly.
-  **NOTE:** The color of your computer and certain components may appear differently than shown in this document.

Before working inside your computer

About this task

-  **NOTE:** The images in this document may differ from your computer depending on the configuration you ordered.

Steps

1. Save and close all open files and exit all open applications.
2. Shut down your computer. For Windows operating system, click **Start** >  **Power** > **Shut down**.

 **NOTE:** If you are using a different operating system, see the documentation of your operating system for shut-down instructions.

3. Disconnect your computer and all attached devices from their electrical outlets.
4. Disconnect all attached network devices and peripherals, such as keyboard, mouse, and monitor from your computer.

 **CAUTION:** To disconnect a network cable, first unplug the cable from your computer and then unplug the cable from the network device.

5. Remove any media card and optical disc from your computer, if applicable.

Safety precautions

The safety precautions chapter details the primary steps to be taken before performing any disassembly instructions.

Observe the following safety precautions before you perform any installation or break/fix procedures involving disassembly or reassembly:

- Turn off the system and all attached peripherals.
- Disconnect the system and all attached peripherals from AC power.
- Disconnect all network cables, telephone, and telecommunications lines from the system.
- Use an ESD field service kit when working inside any to avoid electrostatic discharge (ESD) damage.
- After removing any system component, carefully place the removed component on an anti-static mat.
- Wear shoes with non-conductive rubber soles to reduce the chance of getting electrocuted.

Standby power

Dell products with standby power must be unplugged before you open the case. Systems that incorporate standby power are essentially powered while turned off. The internal power enables the system to be remotely turned on (wake on LAN) and suspended into a sleep mode and has other advanced power management features.

Unplugging, pressing, and holding the power button for 15 seconds should discharge residual power in the system board.

Bonding

Bonding is a method for connecting two or more grounding conductors to the same electrical potential. This is done through the use of a field service electrostatic discharge (ESD) kit. When connecting a bonding wire, ensure that it is connected to bare metal and never to a painted or non-metal surface. The wrist strap should be secure and in full contact with your skin, and ensure that you remove all jewelry such as watches, bracelets, or rings prior to bonding yourself and the equipment.

Electrostatic discharge—ESD protection

ESD is a major concern when you handle electronic components, especially sensitive components such as expansion cards, processors, memory DIMMs, and system boards. Very slight charges can damage circuits in ways that may not be obvious, such as intermittent problems or a shortened product life span. As the industry pushes for lower power requirements and increased density, ESD protection is an increasing concern.

Due to the increased density of semiconductors used in recent Dell products, the sensitivity to static damage is now higher than in previous Dell products. For this reason, some previously approved methods of handling parts are no longer applicable.

Two recognized types of ESD damage are catastrophic and intermittent failures.

- **Catastrophic** – Catastrophic failures represent approximately 20 percent of ESD-related failures. The damage causes an immediate and complete loss of device functionality. An example of catastrophic failure is a memory DIMM that has received a static shock and immediately generates a "No POST/No Video" symptom with a beep code emitted for missing or nonfunctional memory.
- **Intermittent** – Intermittent failures represent approximately 80 percent of ESD-related failures. The high rate of intermittent failures means that most of the time when damage occurs, it is not immediately recognizable. The DIMM receives a static shock, but the tracing is merely weakened and does not immediately produce outward symptoms related to the damage. The weakened trace may take weeks or months to melt, and in the meantime may cause degradation of memory integrity, intermittent memory errors, etc.

The more difficult type of damage to recognize and troubleshoot is the intermittent (also called latent or "walking wounded") failure.

Perform the following steps to prevent ESD damage:

- Use a wired ESD wrist strap that is properly grounded. The use of wireless anti-static straps is no longer allowed; they do not provide adequate protection. Touching the chassis before handling parts does not ensure adequate ESD protection on parts with increased sensitivity to ESD damage.
- Handle all static-sensitive components in a static-safe area. If possible, use anti-static floor pads and workbench pads.
- When unpacking a static-sensitive component from its shipping carton, do not remove the component from the anti-static packing material until you are ready to install the component. Before unwrapping the anti-static packaging, ensure that you discharge static electricity from your body.
- Before transporting a static-sensitive component, place it in an anti-static container or packaging.

ESD field service kit

The unmonitored Field Service kit is the most commonly used service kit. Each Field Service kit includes three main components: anti-static mat, wrist strap, and bonding wire.

Components of an ESD field service kit

The components of an ESD field service kit are:

- **Anti-Static Mat** – The anti-static mat is dissipative and parts can be placed on it during service procedures. When using an anti-static mat, your wrist strap should be snug and the bonding wire should be connected to the mat and to any bare metal on the system being worked on. Once deployed properly, service parts can be removed from the ESD bag and placed directly on the mat. ESD-sensitive items are safe in your hand, on the ESD mat, in the system, or inside a bag.
- **Wrist Strap and Bonding Wire** – The wrist strap and bonding wire can be either directly connected between your wrist and bare metal on the hardware if the ESD mat is not required, or connected to the anti-static mat to protect hardware that is temporarily placed on the mat. The physical connection of the wrist strap and bonding wire between your skin, the ESD mat, and the hardware is known as bonding. Use only Field Service kits with a wrist strap, mat, and bonding wire. Never use wireless wrist straps. Always be aware that the internal wires of a wrist strap are prone to damage from normal wear and tear, and must be checked regularly with a wrist strap tester in order to avoid accidental ESD hardware damage. It is recommended to test the wrist strap and bonding wire at least once per week.
- **ESD Wrist Strap Tester** – The wires inside of an ESD strap are prone to damage over time. When using an unmonitored kit, it is a best practice to regularly test the strap prior to each service call, and at a minimum, test once per week. A wrist strap tester is the best method for doing this test. If you do not have your own wrist strap tester, check with your regional office to find out if they have one. To perform the test, plug the wrist-strap's bonding-wire into the tester while it is strapped to your wrist and push the button to test. A green LED is lit if the test is successful; a red LED is lit and an alarm sounds if the test fails.
- **Insulator Elements** – It is critical to keep ESD sensitive devices, such as plastic heat sink casings, away from internal parts that are insulators and often highly charged.
- **Working Environment** – Before deploying the ESD Field Service kit, assess the situation at the customer location. For example, deploying the kit for a server environment is different than for a desktop or portable environment. Servers are typically installed in a rack within a data center; desktops or portables are typically placed on office desks or cubicles. Always look for a large open flat work area that is free of clutter and large enough to deploy the ESD kit with additional space to accommodate the type of system that is being repaired. The workspace should also be free of insulators that can cause an ESD event. On the work area, insulators such as Styrofoam and other plastics should always be moved at least 12 inches or 30 centimeters away from sensitive parts before physically handling any hardware components.
- **ESD Packaging** – All ESD-sensitive devices must be shipped and received in static-safe packaging. Metal, static-shielded bags are preferred. However, you should always return the damaged part using the same ESD bag and packaging that the new part arrived in. The ESD bag should be folded over and taped shut and all the same foam packing material should be used in the original box that the new part arrived in. ESD-sensitive devices should be removed from packaging only at an ESD-protected work surface, and parts should never be placed on top of the ESD bag because only the inside of the bag is shielded. Always place parts in your hand, on the ESD mat, in the system, or inside an anti-static bag.
- **Transporting Sensitive Components** – When transporting ESD sensitive components such as replacement parts or parts to be returned to Dell, it is critical to place these parts in anti-static bags for safe transport.

ESD protection summary

It is recommended to use the traditional wired ESD grounding wrist strap and protective anti-static mat at all times when servicing Dell products. In addition, it is critical to keep sensitive parts separate from all insulator parts while performing service and that they use anti-static bags for transporting sensitive components.

Transporting sensitive components

When transporting ESD sensitive components such as replacement parts or parts to be returned to Dell, it is critical to place these parts in anti-static bags for safe transport.

Lifting equipment

Adhere to the following guidelines when lifting heavy weight equipment:

 **CAUTION: Do not lift greater than 50 pounds. Always obtain additional resources or use a mechanical lifting device.**

1. Get a firm balanced footing. Keep your feet apart for a stable base, and point your toes out.
2. Tighten stomach muscles. Abdominal muscles support your spine when you lift, offsetting the force of the load.
3. Lift with your legs, not your back.
4. Keep the load close. The closer it is to your spine, the less force it exerts on your back.
5. Keep your back upright, whether lifting or setting down the load. Do not add the weight of your body to the load. Avoid twisting your body and back.
6. Follow the same techniques in reverse to set the load down.

After working inside your computer

About this task

 **NOTE:** Leaving stray or loose screws inside your computer may severely damage your computer.

Steps

1. Replace all screws and ensure that no stray screws remain inside your computer.
2. Connect any external devices, peripherals, or cables you removed before working on your computer.
3. Replace any media cards, discs, or any other parts that you removed before working on your computer.
4. Connect your computer and all attached devices to their electrical outlets.
5. Turn on your computer.

BitLocker

 **CAUTION: If BitLocker is not suspended before updating the BIOS, the next time you reboot the system it will not recognize the BitLocker key. You will then be prompted to enter the recovery key to progress, and the system will ask for this on each reboot. If the recovery key is not known this can result in data loss or an unnecessary operating system reinstall. For more information about this subject, see Knowledge Article: [updating the BIOS on Dell systems with BitLocker enabled.](#)**

The installation of the following components triggers BitLocker:

- Hard disk drive or solid state drive
- System board

Recommended tools

The procedures in this document may require the following tools:

- Phillips screwdriver #0
- Phillips screwdriver #1
- Plastic scribe

Screw list

NOTE: When removing screws from a component, it is recommended to note the screw type, the quantity of screws, and then place them in a screw storage box. This is to ensure that the correct number of screws and correct screw type is restored when the component is replaced.

NOTE: Some computers have magnetic surfaces. Ensure that the screws are not left attached to such surfaces when replacing a component.

NOTE: Screw color may vary with the configuration ordered.

Table 23. Screw list















Component	Screw type	Quantity	Screw image
Left-Side cover	Captive screw	2	
M.2 2230/2280 Solid-state drive	M2x3.5	1	
2.5-inch Hard-disk drive	M3x3.5	4	
3.5-inch Hard-disk drive	6-32	4	
WLAN card	M2x3.5	1	
Power-supply unit	#6-32	3	
125 W heat-sink assembly	Captive screw	4	
Processor fan (for 125 W heat-sink assembly)	Captive screw	4	
VR heat sink	Captive screw	2	
Serial/VGA module	4-40x6.5	2	

Table 23. Screw list (continued)

Component	Screw type	Quantity	Screw image
DisplayPort/HDMI module	M3x3	2	
System board	#6-32	2	
	6-32	1	
	6-32	8	

Major components of OptiPlex Tower 7010

The following image shows the major components of OptiPlex Tower 7010.

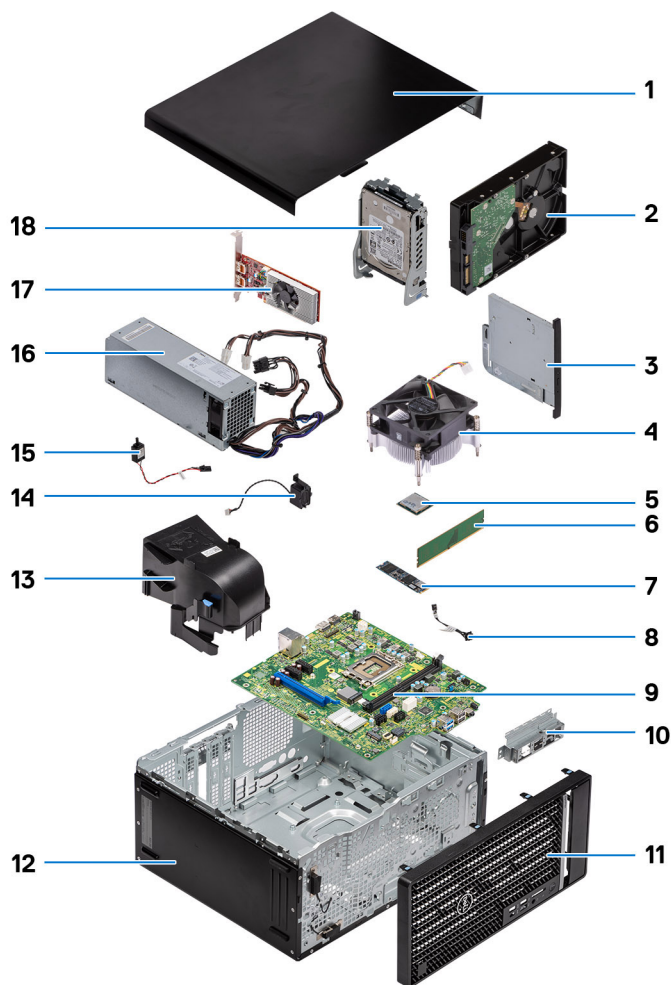

- 1. Side cover
- 2. 3.5-inch hard-disk drive
- 3. Slim ODD
- 4. Heat sink and fan assembly
- 5. Processor
- 6. Memory module

7. M.2 2280 solid-state drive
9. System board
11. Front bezel
13. System fan duct
15. Intrusion switch
17. Graphics card
8. Power-button cable
10. Front I/O bracket
12. System chassis
14. Speaker
16. Power-supply unit
18. 2.5-inch hard-disk drive

 **NOTE:** Dell provides a list of components and their part numbers for the original system configuration purchased. These parts are available according to warranty coverages purchased by the customer. Contact your Dell sales representative for purchase options.

Removing the side cover

Prerequisites

1. Follow the procedure in [before working inside your computer](#).

 **NOTE:** Ensure that you remove the security cable from the security-cable slot (if applicable).

About this task

The following images indicate the location of the side cover and provide a visual representation of the removal procedure.



2x
6x32





Steps

1. Loosen the two thumbscrews that secure the side cover to the computer.
2. Slide the side cover towards the rear of the computer and lift the side cover away from the chassis.

Installing the side cover

Prerequisites

If you are replacing a component, remove the existing component before performing the installation procedure.

About this task

The following images indicate the location of the side cover and provide a visual representation of the installation procedure.





2x
6x32



Steps

1. Align the tabs on the side cover with the slots on the chassis.
2. Slide the side cover towards the front of the computer to install it.
3. Tighten the two thumbscrews to secure the side cover to the chassis.

Next steps

1. Follow the procedure in [after working inside your computer](#).

Removing and installing Customer Replaceable Units (CRUs)

The replaceable components in this chapter are Customer Replaceable Units (CRUs).

 **CAUTION:** Customers can replace only the Customer Replaceable Units (CRUs) following the safety precautions and replacement procedures.

 **NOTE:** The images in this document may differ from your computer depending on the configuration you ordered.

Front bezel

Removing the front bezel

Prerequisites

1. Follow the procedure in [before working inside your computer](#).
2. Remove the [side cover](#).

About this task

The following images indicate the location of the front bezel and provide a visual representation of the removal procedure.

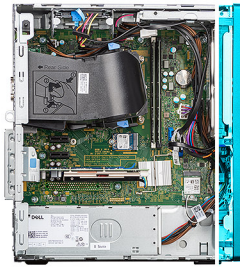

Steps

1. Gently pry and release the front-bezel tabs sequentially from the top.
2. Rotate the front bezel outward from the chassis and remove the front bezel.

Installing the front bezel

Prerequisites

If you are replacing a component, remove the existing component before performing the installation procedure.

About this task

The following images indicate the location of the front bezel and provide a visual representation of the installation procedure.

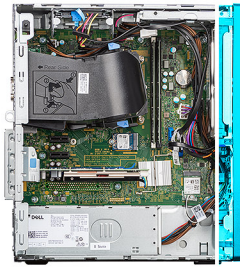

Steps

1. Align the front-cover tabs with the slots on the chassis.
2. Rotate the front cover towards the chassis and snap it into place.

Next steps

1. Install the [side cover](#).
2. Follow the procedure in [after working inside your computer](#).

Hard drive

2.5-inch hard drive

Removing the 2.5-inch hard drive

Prerequisites

1. Follow the procedure in [before working inside your computer](#).
2. Remove the [side cover](#).

About this task

The following images indicate the location of the 2.5-inch hard drive and provide a visual representation of the removal procedure.



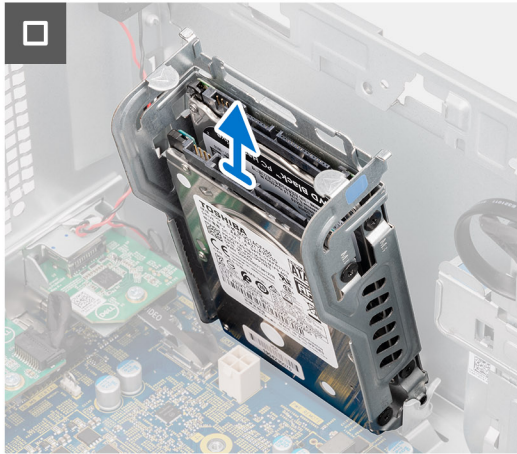
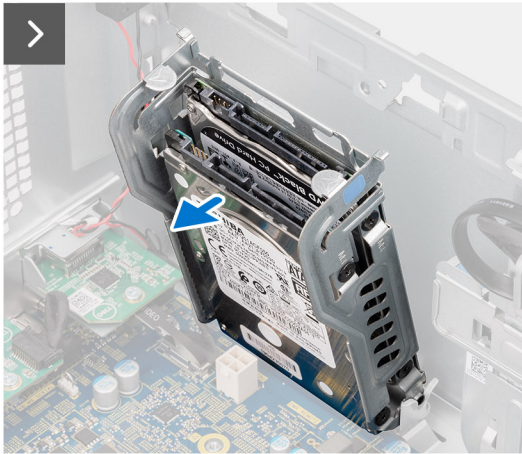
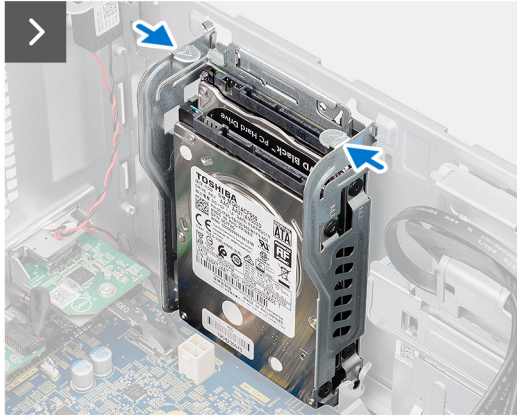
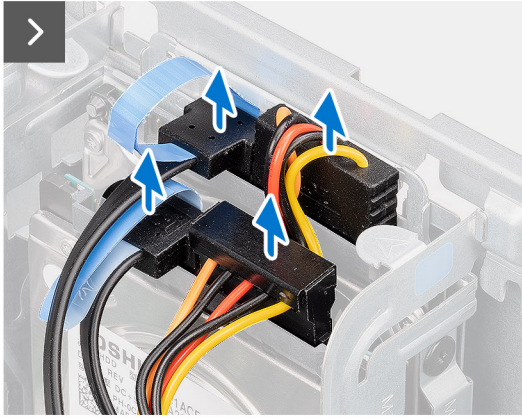
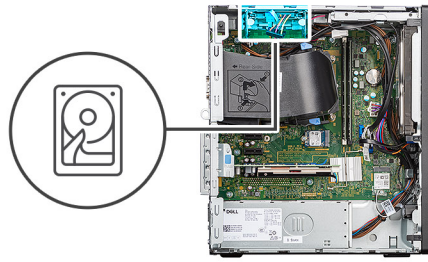

4x
M3x3.5

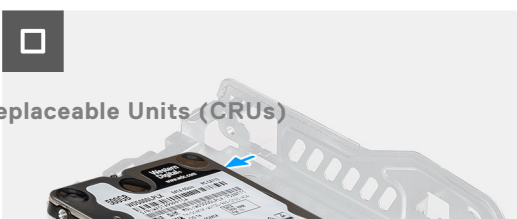
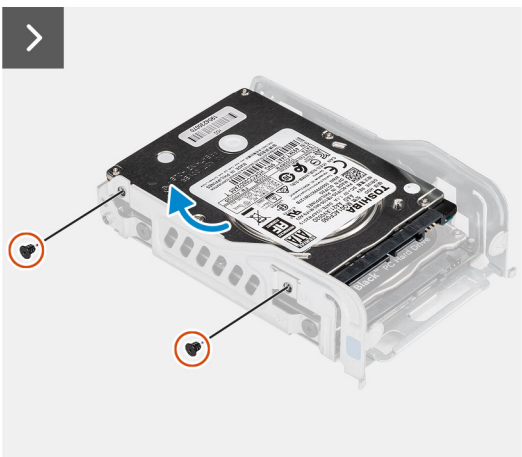

Steps

1. Disconnect the data and power cables from the connectors on the hard-drive.
2. Press the tabs on the hard-drive carrier and lift the hard-drive carrier to remove the hard-drive assembly from the chassis.
i **NOTE:** Note the orientation of the hard drive so that you can replace it correctly.
3. Remove the four screws (M3x3.5) that secure the hard drive to the hard-drive carrier.
4. Lift the 2.5-inch hard drive off the hard-drive carrier.

Installing the 2.5-inch hard drive

Prerequisites

If you are replacing a component, remove the existing component before performing the installation procedure.

About this task

The following image indicates the location of the 2.5-inch hard drive and provides a visual representation of the installation procedure.



4x
M3x3.5

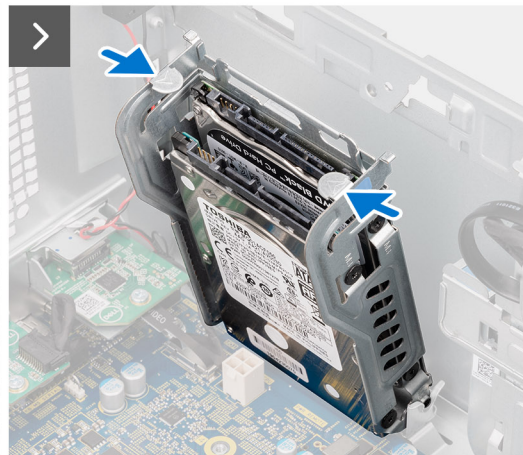
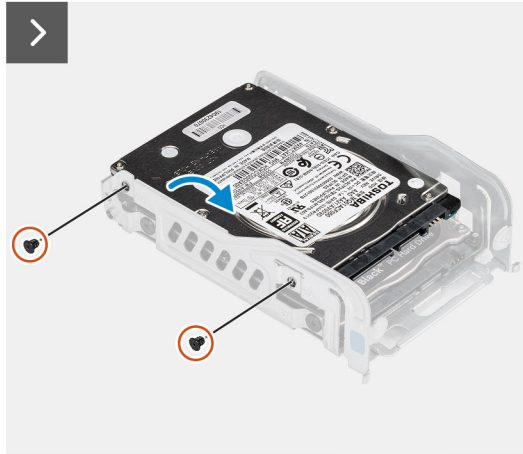
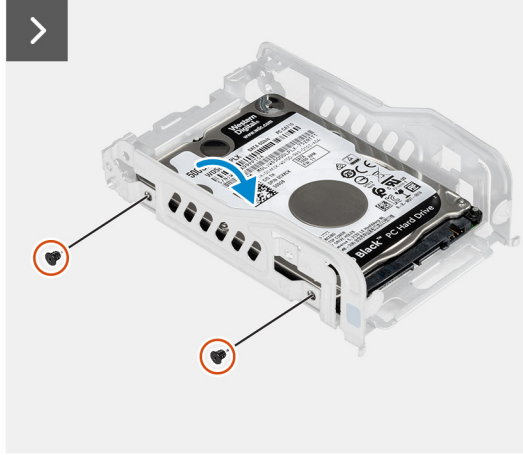

Steps

1. Align the screw holes on the hard-drive with the screw holes on the hard-drive carrier.
2. Replace the four screws (M3x3.5) that secure the hard drive to the hard-drive carrier.
3. Insert the hard-drive assembly into the slot on the computer until it clicks into place.

Next steps

1. Install the [side cover](#).
2. Follow the procedure in [after working inside your computer](#).

3.5-inch hard drive

Removing the 3.5-inch hard drive

Prerequisites

1. Follow the procedure in [before working inside your computer](#).
2. Remove the [side cover](#).
3. Remove the [front bezel](#).

About this task

The following images indicate the location of the 3.5-inch hard drive and provide a visual representation of the removal procedure.



4x
6-32

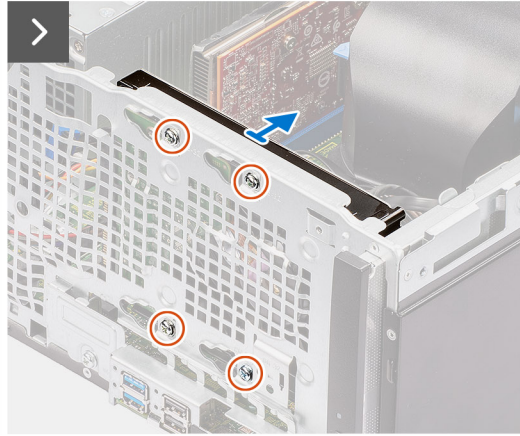
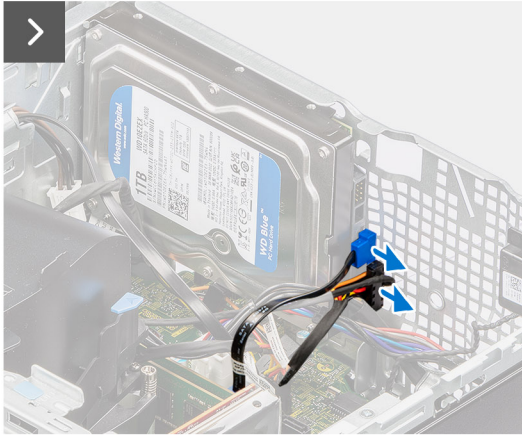

Steps

1. Disconnect the data and power cables from the hard drive.
2. Remove the four (#6-32) screws that secure the hard-drive to the chassis.
3. Remove hard-drive away from the chassis.

Installing the 3.5-inch hard drive

Prerequisites

If you are replacing a component, remove the existing component before performing the installation procedure.

About this task

The following image indicates the location of the 3.5-inch hard drive and provides a visual representation of the installation procedure.



4x
6-32

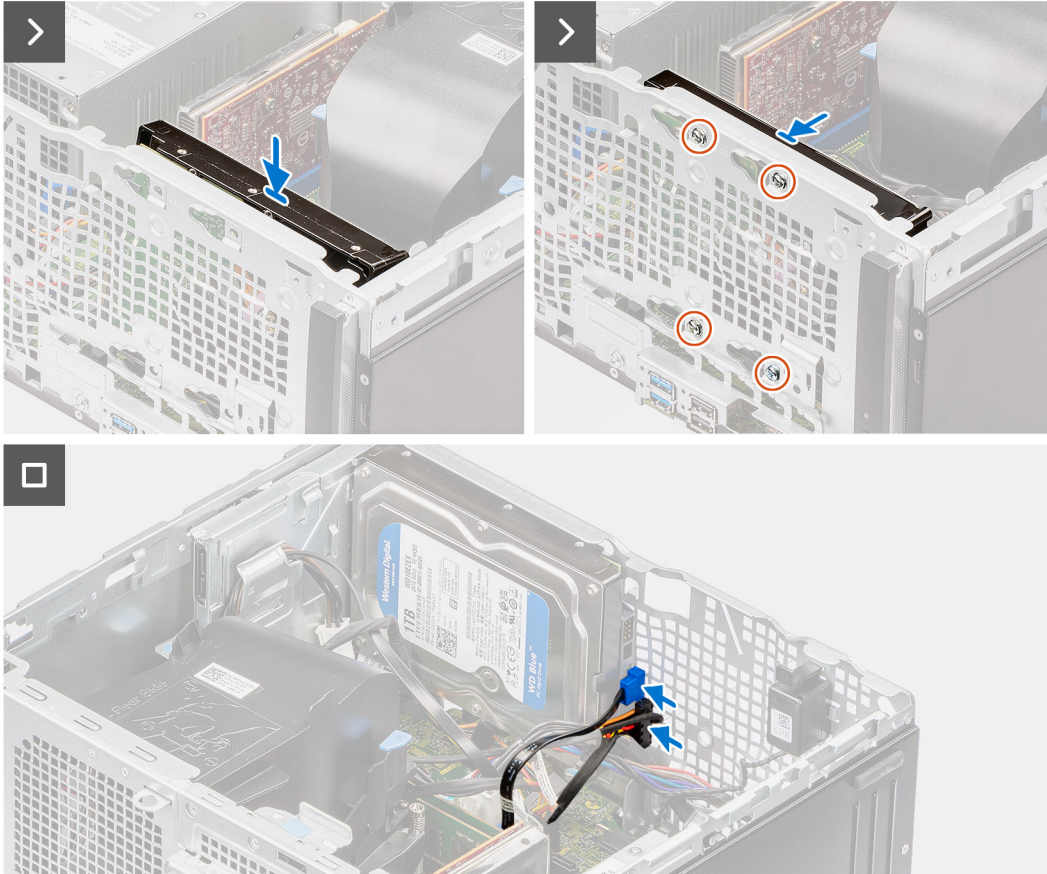

Steps

1. Align the screw holes on the hard-drive with the chassis.
2. Replace the four (#6-32) screws to secure the hard-drive to the chassis.
3. Connect the data and power cables to the connectors on the hard drive.

Next steps

1. Install the [front bezel](#).
2. Install the [side cover](#).
3. Follow the procedure in [after working inside your computer](#).

Optical drive

Removing the optical drive

Prerequisites

1. Follow the procedure in [before working inside your computer](#).

2. Remove the [side cover](#).

About this task

The following images indicate the location of the optical drive and provide a visual representation of the removal procedure.

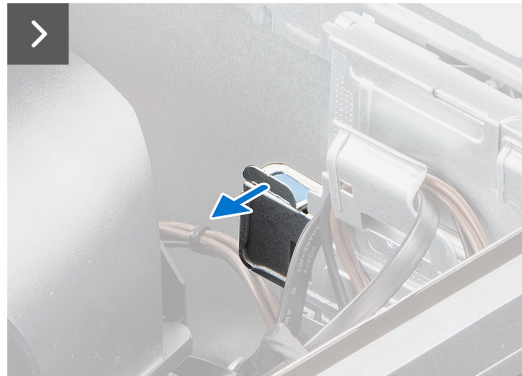
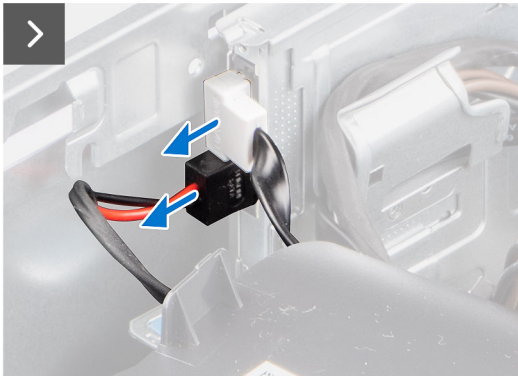
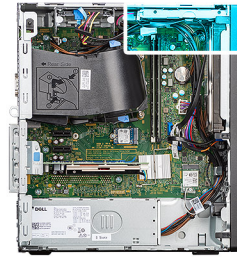

Steps

1. Disconnect the data and power cables from the optical drive.
2. Pull the securing tab to release the optical drive from the chassis.
3. Slide and remove the optical drive from the slot on the chassis.

Installing the optical drive

Prerequisites

If you are replacing a component, remove the existing component before performing the installation procedure.

About this task

The following images indicate the location of the optical drive and provide a visual representation of the installation procedure.

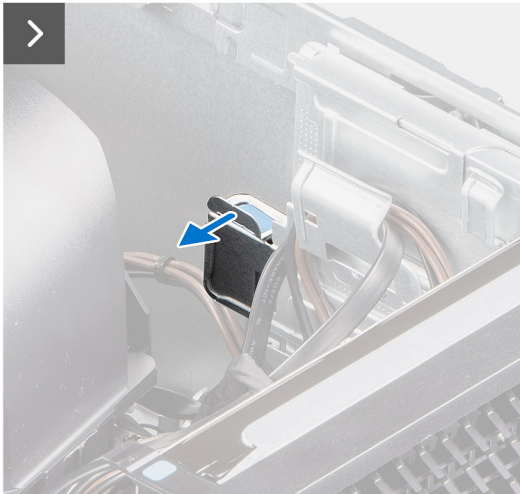
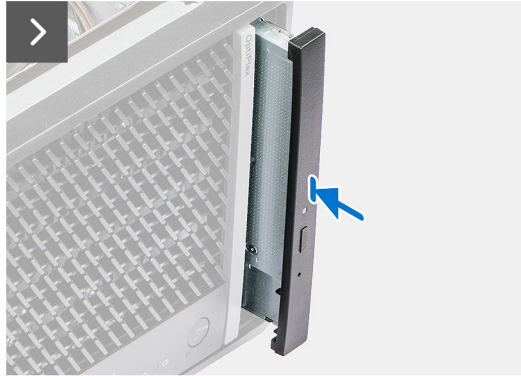
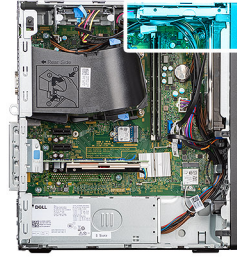

Steps

1. Insert the optical drive assembly into the slot on the chassis.
2. Slide the optical drive until it snaps into place.
3. Connect the data and power cables to the connectors on the optical drive.

Next steps

1. Install the [side cover](#).
2. Follow the procedure in [after working inside your computer](#).

Memory

Removing the memory

Prerequisites

1. Follow the procedure in [before working inside your computer](#).
2. Remove the [side cover](#).

About this task

The following images indicate the location of the memory and provide a visual representation of the removal procedure.

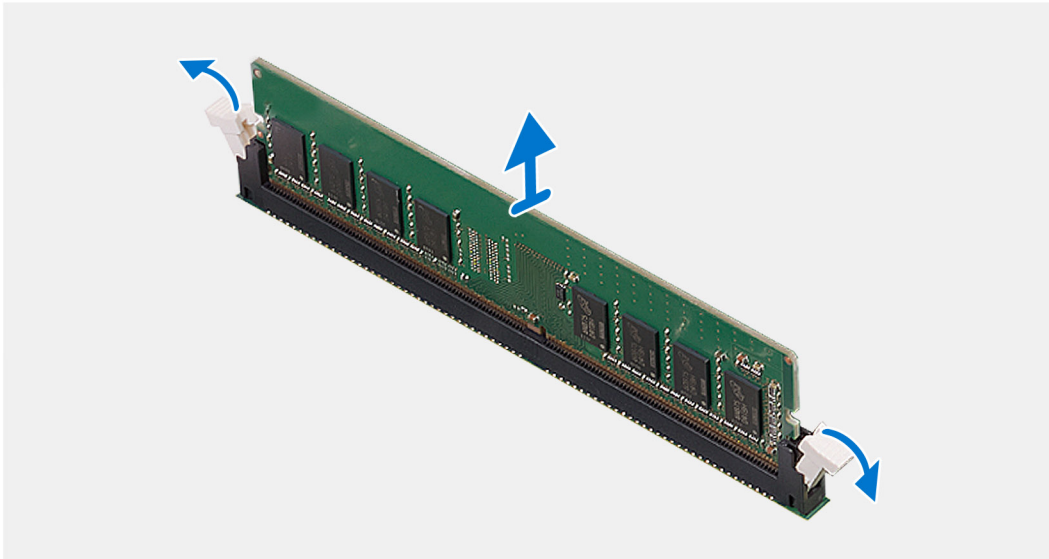
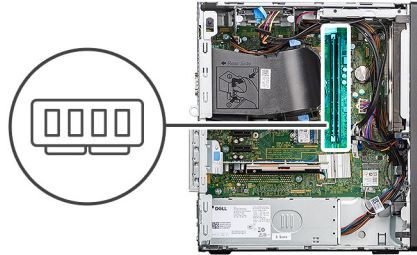

Steps

1. Use your fingertips to carefully spread apart the securing-clips on each end of the memory-module slot..
2. Grasp the memory module near the securing clip, and then gently ease the memory module out of the memory-module slot.

CAUTION: To prevent damage to the memory module, hold the memory module by the edges. Do not touch the components on the memory module.

NOTE: Repeat step 1 to step 2 to remove any other memory modules installed in your computer.

NOTE: Note the slot and the orientation of the memory module in order to replace it in the correct slot.

NOTE: If the memory module is difficult to remove, gently ease the memory module back and forth to remove it from the slot.

Installing the memory

Prerequisites

If you are replacing a component, remove the existing component before performing the installation procedure.

About this task

The following image indicates the location of the memory and provides a visual representation of the installation procedure.

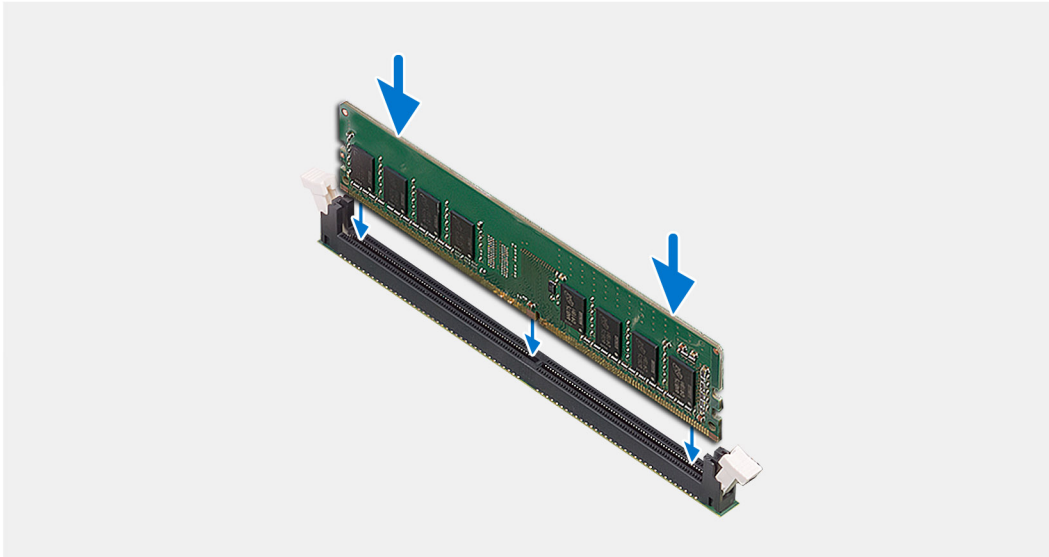
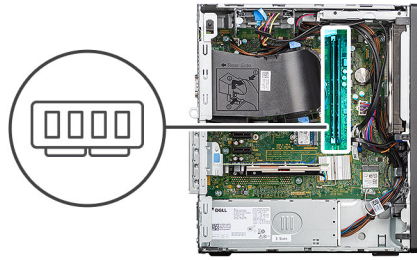

Steps

1. Ensure that the securing clips are in an open position.
2. Align the notch on the memory module with the tab on the memory-module slot.
3. Press down on the memory module until the memory module snaps into position and the securing clip locks in place.

i **NOTE:** If you do not hear the click, remove the memory module and reinstall it.

⚠ **CAUTION:** To prevent damage to the memory module, hold the memory module by the edges. Do not touch the components on the memory module.

i **NOTE:** Repeat step 1 to step 3 to install more than one memory module in your computer.

Next steps

1. Install the [side cover](#).
2. Follow the procedure in [after working inside your computer](#).

Solid-state drives

Solid-state drive (half-length)

Removing the M.2230 solid-state drives

Prerequisites

1. Follow the procedure in [Before working inside your computer](#).
2. Remove the [side cover](#).

About this task

The following images indicate the location of the M.2230 solid-state drives and provides a visual representation of the removal procedure.



Steps

1. Remove the screw (M2x3.5) that secures the M.2230 solid-state drive to the system board.
2. Slide and lift the M.2230 solid-state drive from the M.2 card slot on the system board.

Installing the M.2230 solid-state drives

Prerequisites

If you are replacing a component, remove the existing component before performing the installation procedure.

About this task

The following images indicate the location of the M.2230 solid-state drives and provides a visual representation of the installation procedure.



1x
M2x3.5

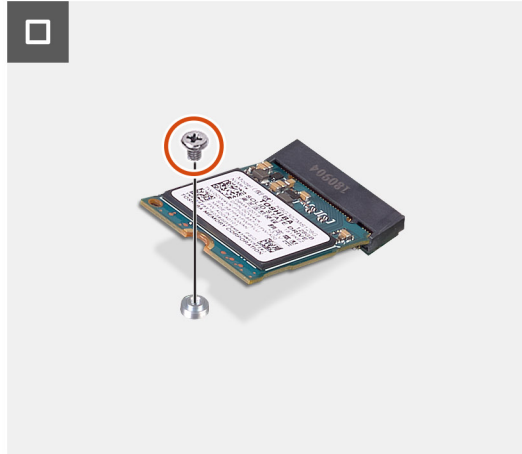
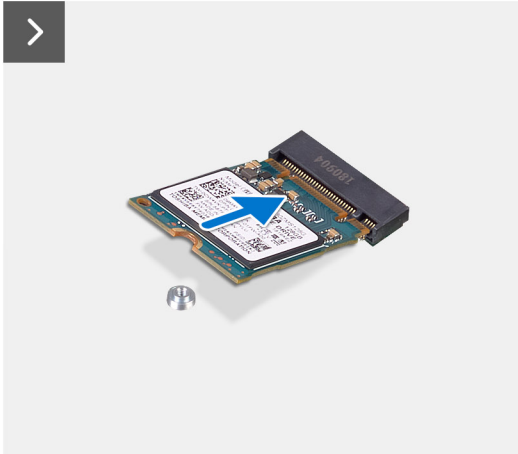
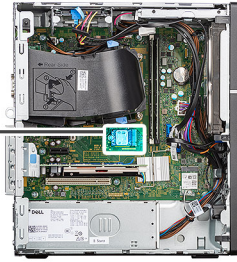

Steps

1. Align the notch on the M.2230 solid-state drive with the tab on the M.2 card slot on the system board.
2. Slide the M.2230 solid-state drive into the M.2 card slot on the system board.
3. Replace the screw (M2x3.5) that secures the M.2230 solid-state drive to the system board.

Next steps

1. Install the [side cover](#).
2. Follow the procedure in [After working inside your computer](#).

Solid-state drive (full-length)

Removing the M.2280 solid-state drive

Prerequisites

1. Follow the procedure in [Before working inside your computer](#).
2. Remove the [side cover](#).

About this task

The following images indicate the location of the M.2280 solid-state drive and provides a visual representation of the removal procedure.



1x
M2x3.5

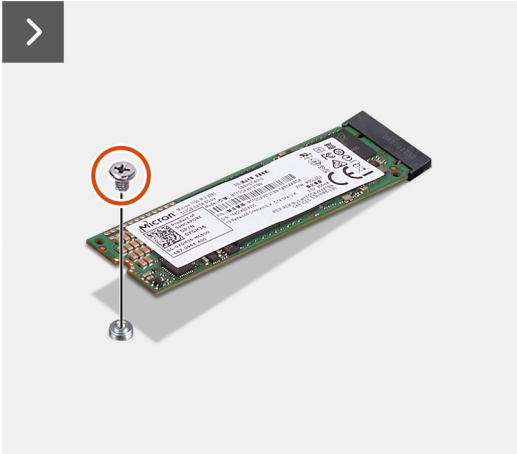
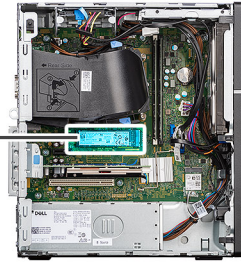

Steps

1. Remove the screw (M2x3.5) that secures the M.2280 solid-state drive to the system board.
2. Slide and lift the M.2280 solid-state drive from the M.2 card slot on the system board.

Installing the M.2280 solid-state drive

Prerequisites

If you are replacing a component, remove the existing component before performing the installation procedure.

About this task

The following images indicate the location of the M.2280 solid-state drive and provides a visual representation of the installation procedure.



1x
M2x3.5

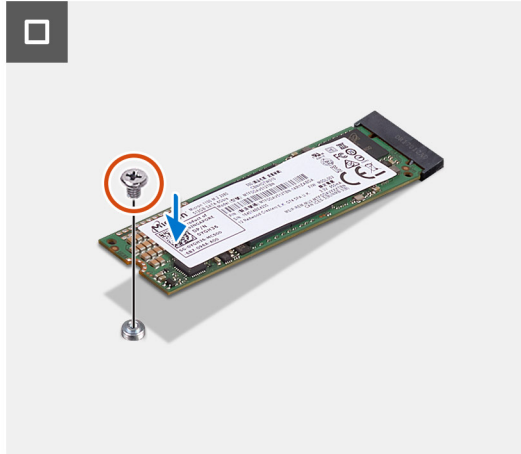
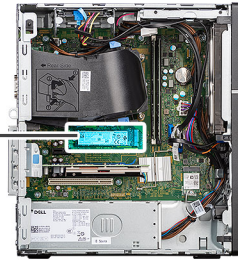

Steps

1. Align the notch on the M.2280 solid-state drive with the tab on the M.2 card slot on the system board.
2. Slide the M.2280 solid-state drive into the M.2 card slot on the system board.
3. Replace the screw (M2x3.5) that secures the M.2280 solid-state drive to the system board.

Next steps

1. Install the [side cover](#).
2. Follow the procedure in [After working inside your computer](#).

Wireless card

Removing the wireless card

Prerequisites

1. Follow the procedure in [before working inside your computer](#).
2. Remove the [side cover](#).

About this task

The following images indicate the location of the wireless card and provide a visual representation of the removal procedure.



1x
M2x3.5

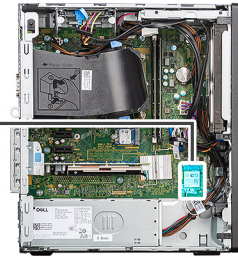

Steps

1. Remove the (M2x3.5) screw that secures the wireless card to the system board.
2. Lift the wireless card bracket away from the wireless card.
3. Disconnect the antenna cables from the wireless card.
4. Slide and remove the wireless card from the connector on the system board.

Installing the wireless card

Prerequisites

If you are replacing a component, remove the existing component before performing the installation procedure.

About this task

The following image indicates the location of the wireless card and provides a visual representation of the installation procedure.



1x
M2x3.5

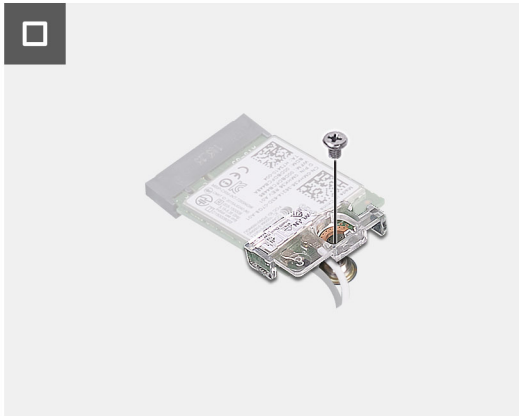
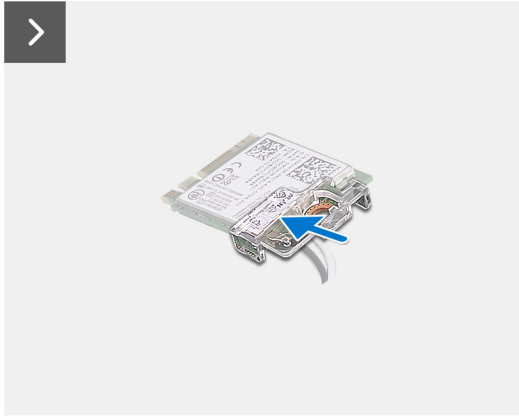
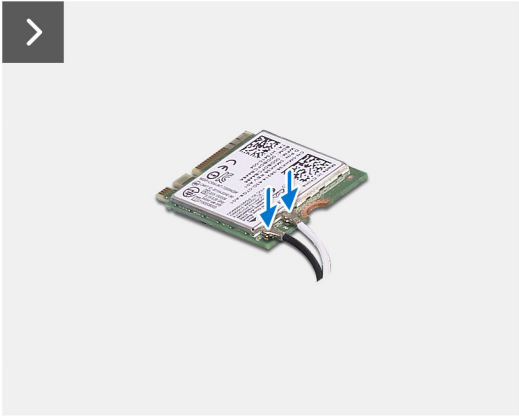
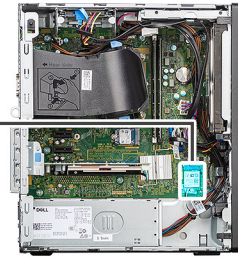

Steps

1. Connect the antenna cables to the wireless card.
The following table provides the antenna-cable color scheme for the wireless card of your computer.

Table 24. Antenna-cable color scheme

Connectors on the wireless card	Antenna-cable color
Main (white triangle)	White
Auxiliary (black triangle)	Black

2. Place the wireless card bracket to secure the wireless antenna cables.
3. Insert the wireless card into the connector on the system board.
4. Replace the (M2x3.5) screw to secure the plastic tab to the wireless card.

Next steps

1. Install the [side cover](#).
2. Follow the procedure in [after working inside your computer](#).

Expansion card

Removing the graphics card

Prerequisites

1. Follow the procedure in [Before working inside your computer](#).
2. Remove the [side cover](#).

About this task

The following images indicate the location of the graphics card and provides a visual representation of the removal procedure.

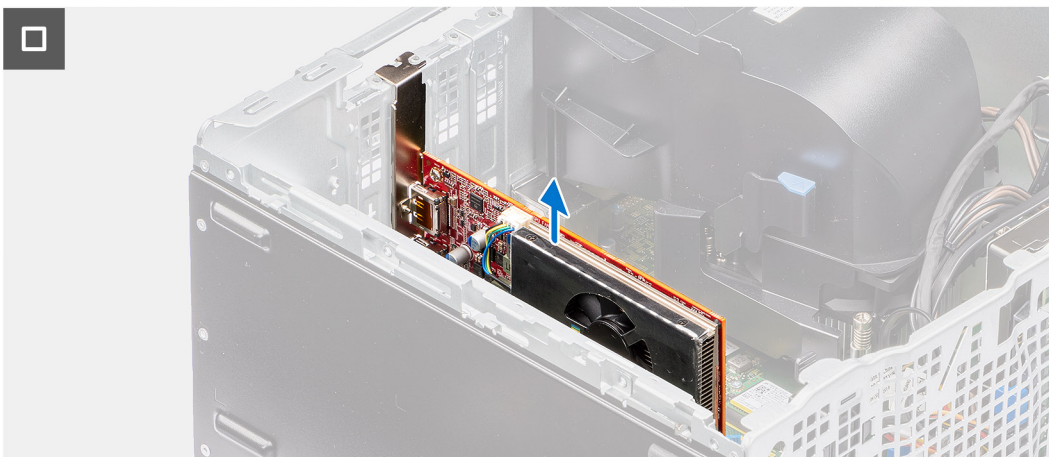
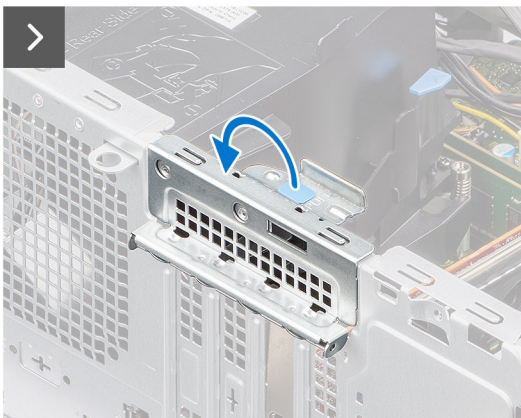

Steps

1. Pull to open the PCIe door.
2. Push and hold the securing tab on the graphics-card slot and lift the graphics card from the graphics-card slot

Installing the graphics card

Prerequisites

If you are replacing a component, remove the existing component before performing the installation procedure.

About this task

The following images indicate the location of the graphics card and provides a visual representation of the installation procedure.

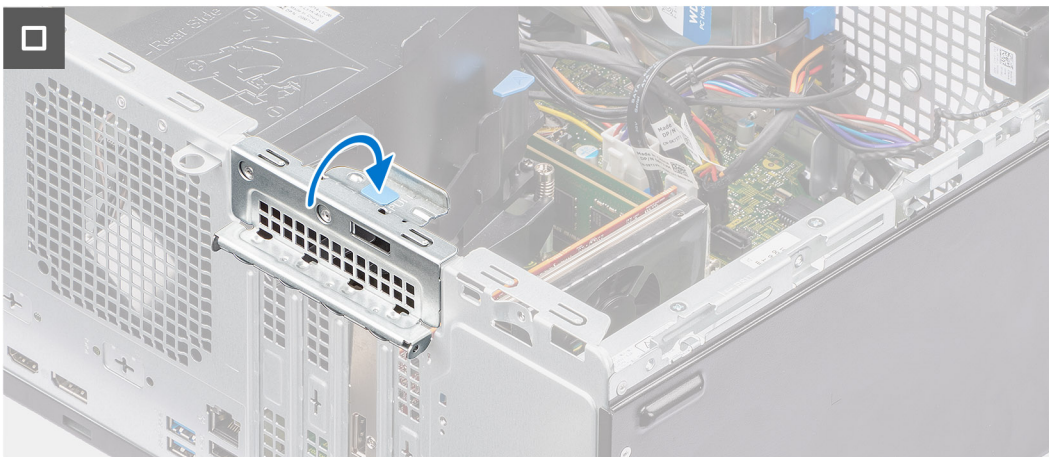
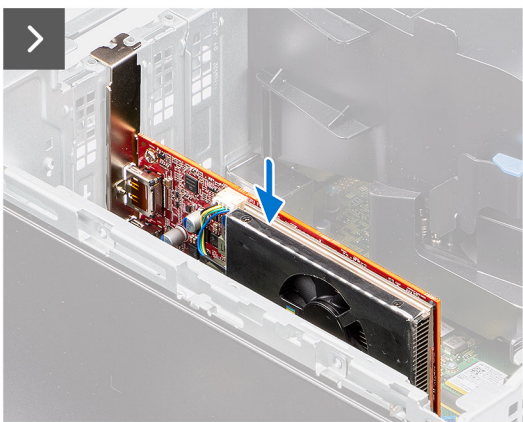

Steps

1. Align the graphics card with the PCIe card connector on the system board.
2. Using the alignment post, connect the card in the connector and press down firmly. Ensure that the card is firmly seated.
3. Rotate to close the PCIe door that secures the graphics card.

Next steps

1. Install the [side cover](#).
2. Follow the procedure in [After working inside your computer](#).

Internal speaker

Removing the speaker

Prerequisites

1. Follow the procedure in [Before working inside your computer](#).
2. Remove the [side cover](#).

About this task

The following images indicate the location of the speaker and provides a visual representation of the removal procedure.



Steps

1. Disconnect the speaker cable from the connector on the system board.
2. Remove the speaker cable from the routing guides on the chassis.
3. Press the tab, lift and slide the speaker along with the cable from the slot on the chassis.

Installing the speaker

Prerequisites

If you are replacing a component, remove the existing component before performing the installation procedure.

About this task

The following images indicate the location of the speaker and provides a visual representation of the installation procedure.

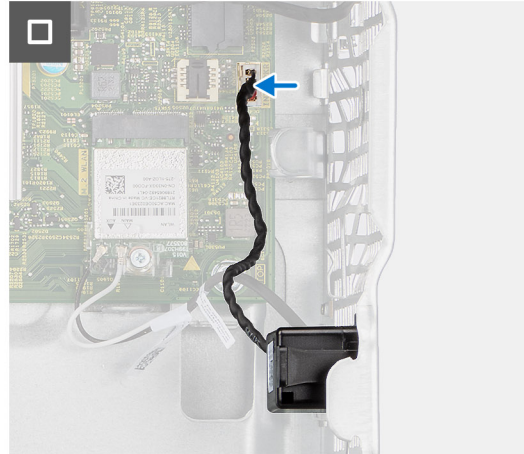

Steps

1. Press the tab on the speaker and slide the speaker into the slot on the chassis until it snaps into place.
2. Press down on the speaker to secure the speaker with the tab on the chassis.
3. Route the speaker cable through the routing guide on the chassis.
4. Connect the speaker cable to the connector on the system board.

Next steps

1. Install the [side cover](#).
2. Follow the procedure in [After working inside your computer](#).

Coin-cell battery

Removing the coin-cell battery

Prerequisites

1. Follow the procedure in [Before working inside your computer](#).
2. Remove the [side cover](#).

About this task

The following images indicate the location of the coin-cell battery and provides a visual representation of the removal procedure.

⚠ CAUTION: Removing the coin-cell battery will clear the CMOS and reset BIOS settings.

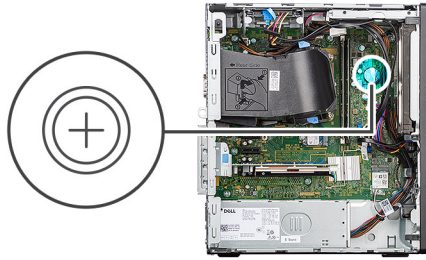

Steps

1. Push the coin-cell battery-release lever on the coin-cell battery socket to release the coin-cell battery out of the socket.
2. Remove the coin-cell battery.

Installing the coin-cell battery

Prerequisites

If you are replacing a component, remove the existing component before performing the installation procedure.

About this task

The following images indicate the location of the speaker and provides a visual representation of the installation procedure.

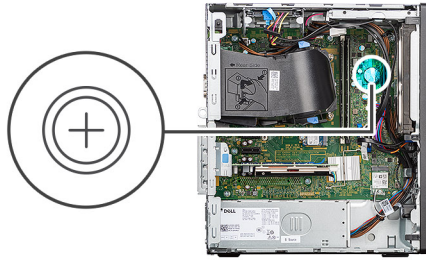

Steps

Insert the coin-cell battery into the socket with the positive side (+) label facing up and snap the battery in the socket.

Next steps

1. Install the [side cover](#).
2. Follow the procedure in [After working inside your computer](#).

Removing and installing Field Replaceable Units (FRUs)

The replaceable components in this chapter are Field Replaceable Units (FRUs).

CAUTION: The information in this section is intended for authorized service technicians only.

CAUTION: To avoid any potential damage to the component or loss of data, ensure that an authorized service technician replaces the Field Replaceable Units (FRUs).

CAUTION: Dell Technologies recommends that this set of repairs, if needed, to be conducted by trained technical repair specialists.

CAUTION: As a reminder, your warranty does not cover damages that may occur during the courses of FRU repairs that are not authorized by Dell Technologies.

NOTE: The images in this document may differ from your computer depending on the configuration you ordered.

Intrusion switch

Removing the intrusion switch

Prerequisites

1. Follow the procedure in [before working inside your computer](#).
2. Remove the [side cover](#).

About this task

The following image indicates the location of the intrusion switch and provides a visual representation of the removal procedure.

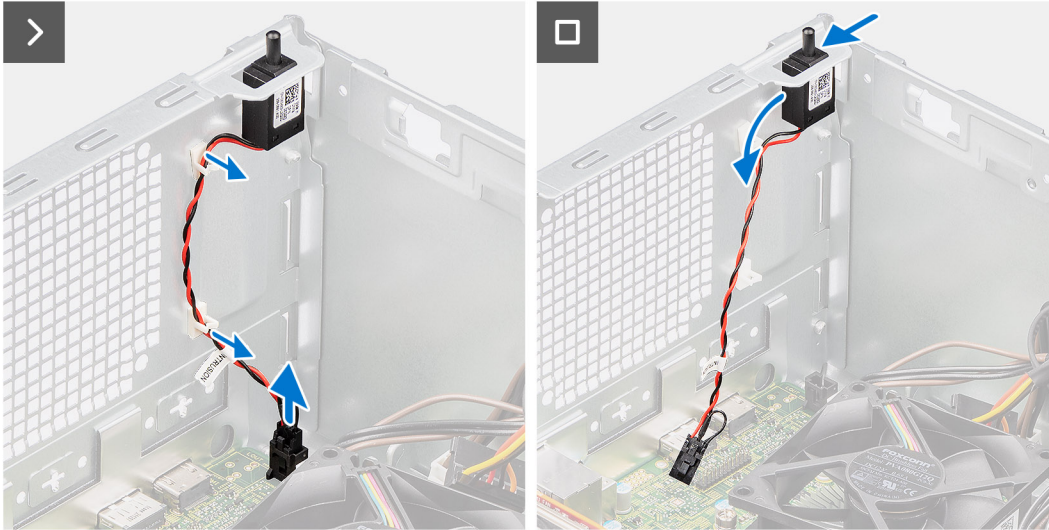
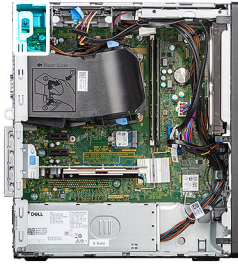

Steps

1. Disconnect the intruder cable from the connector on the system board.
2. Unhook the intruder cable from the retention clip.
3. Slide and remove the intrusion switch from the chassis.

Installing the intrusion switch

Prerequisites

If you are replacing a component, remove the existing component before performing the installation procedure.

About this task

The following image indicates the location of the intrusion switch and provides a visual representation of the installation procedure.

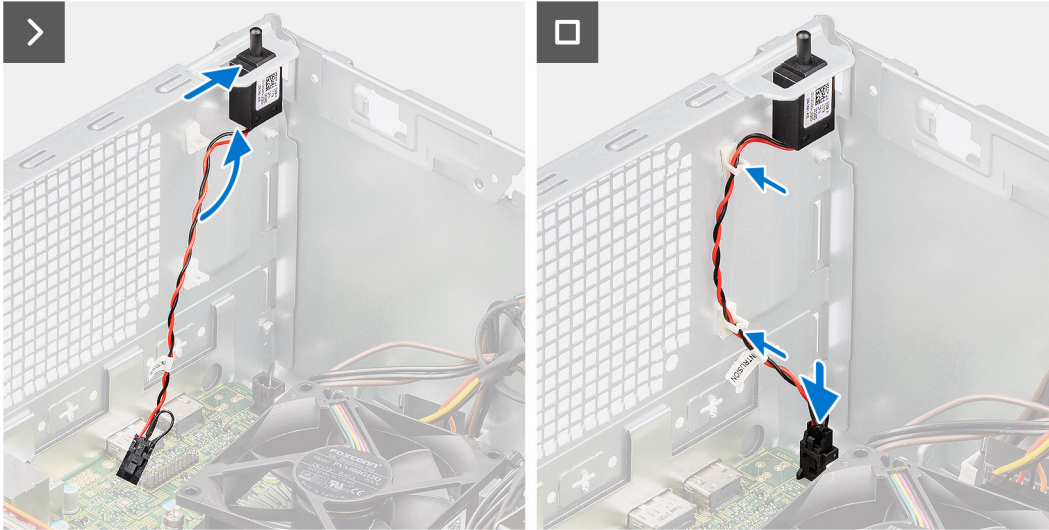
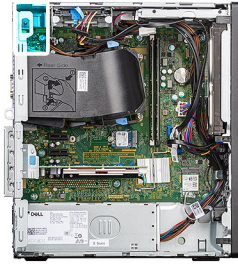

Steps

1. Insert the intrusion switch into its slot and slide the switch to secure it into the slot.
2. Route the intruder cable through the retention clip.
3. Connect the intruder cable to the connector on the system board.

Next steps

1. Install the [side cover](#).
2. Follow the procedure in [after working inside your computer](#).

Power-supply unit

Removing the power-supply unit

⚠ CAUTION: The information in this section is intended for authorized service technicians only.

Prerequisites

1. Follow the procedure in [Before working inside your computer](#).
2. Remove the [side cover](#).

About this task

The following images indicate the location of the power-supply unit and provides a visual representation of the removal procedure.

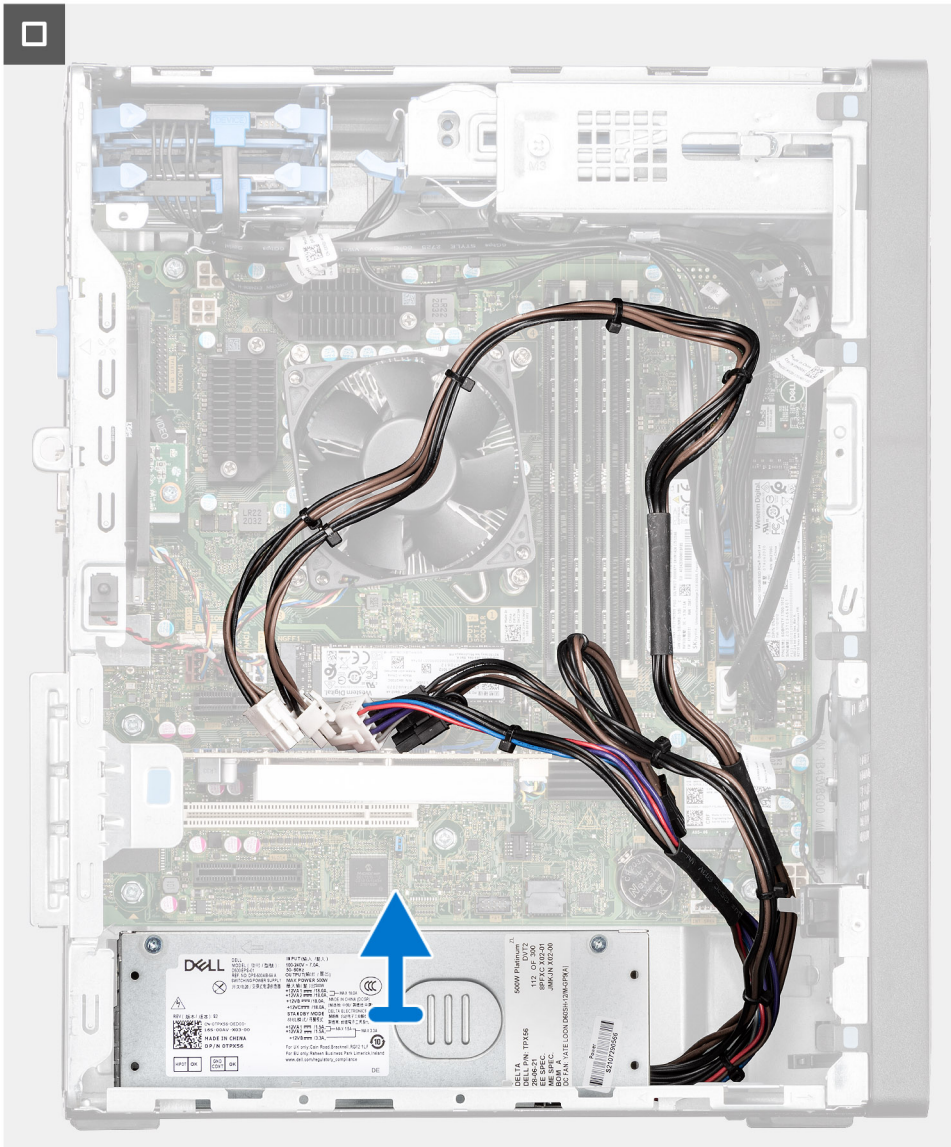



3x
#6-32

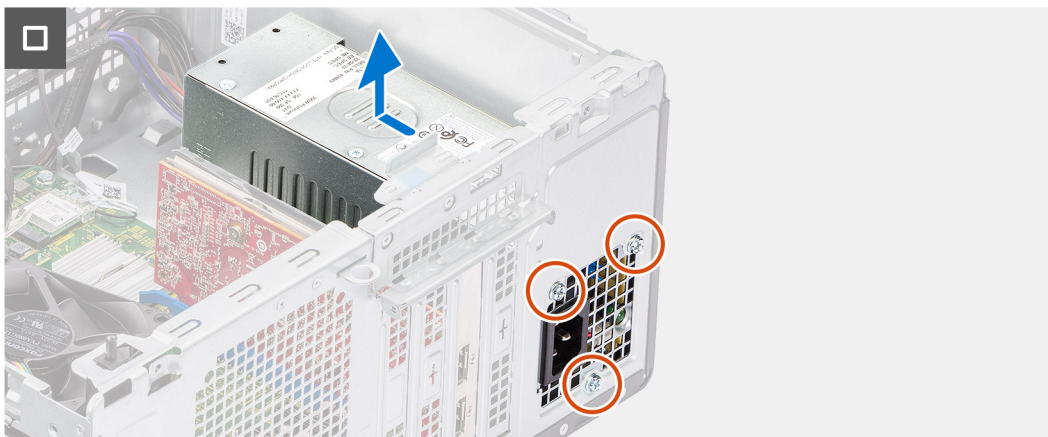
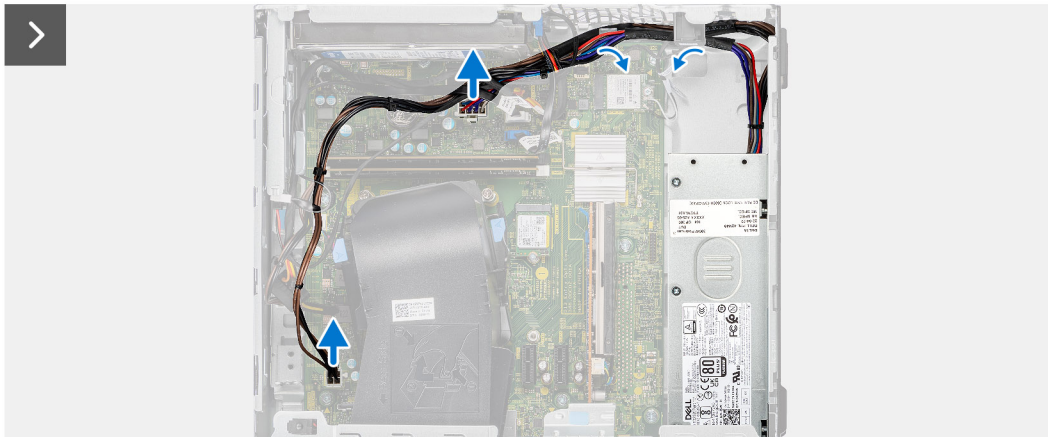
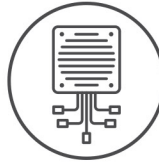

Steps

1. Disconnect the power-supply cables from their connectors on the system board.
2. Remove the power-supply cables from the routing guides on the chassis.
3. Remove the three screws (#6-32) that secure the power-supply unit to the chassis.
4. Slide and lift the power-supply unit off the chassis.

Installing the power-supply unit

CAUTION: The information in this section is intended for authorized service technicians only.

Prerequisites

If you are replacing a component, remove the existing component before performing the installation procedure.

About this task

The following images indicate the location of the power-supply unit and provides a visual representation of the installation procedure.

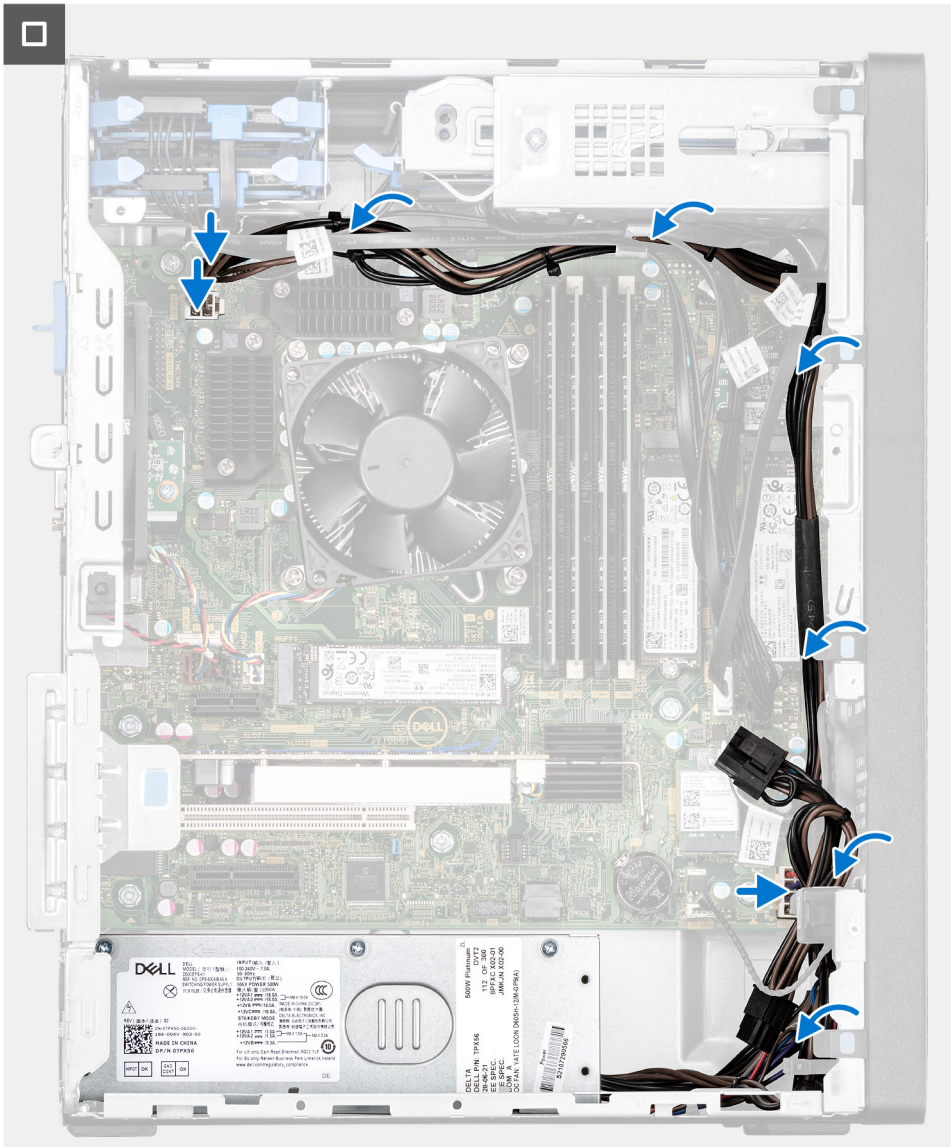



3x
#6-32

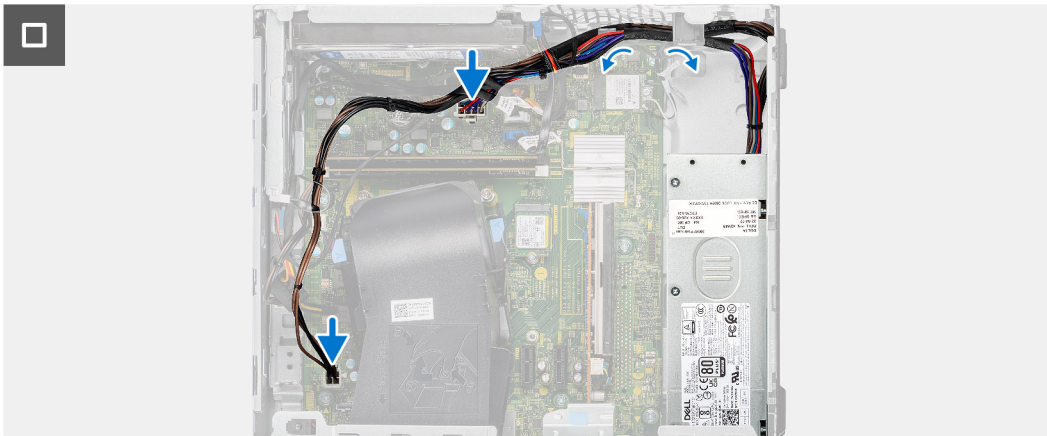
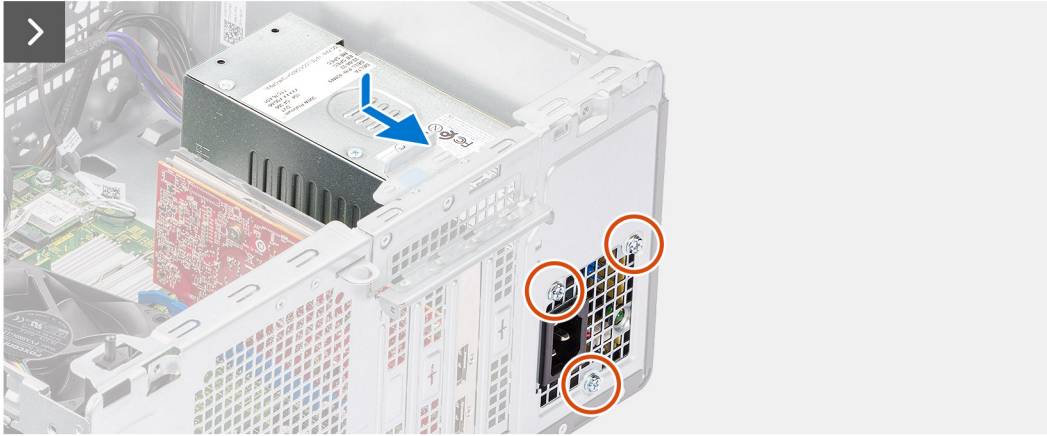
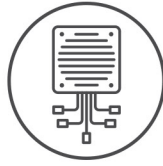

Steps

1. Place the power-supply unit on the chassis and slide it towards the back of the chassis.
2. Replace the three (#6-32) screws to secure the power-supply unit to the chassis.
3. Route the power-supply cables through their routing guides on the chassis.
4. Connect the power-supply cables to their connectors on the system board.

Next steps

1. Install the [side cover](#).
2. Follow the procedure in [after working inside your computer](#).

Fan duct

Removing the fan duct

Prerequisites

1. Follow the procedure in [before working inside your computer](#).

2. Remove the [side cover](#).

About this task

The following images indicate the location of the fan duct and provide a visual representation of the removal procedure.

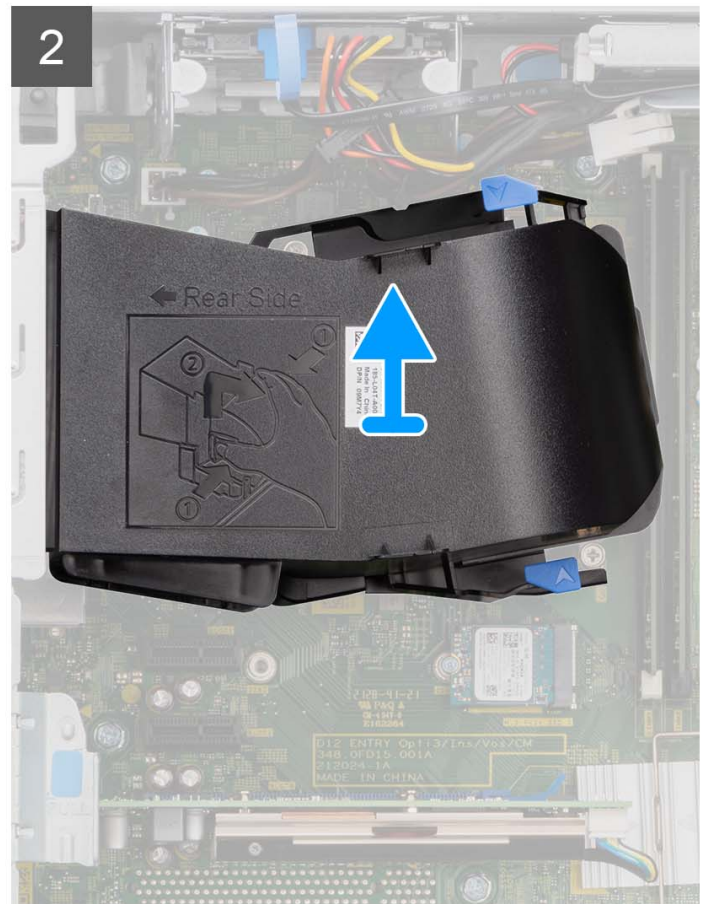
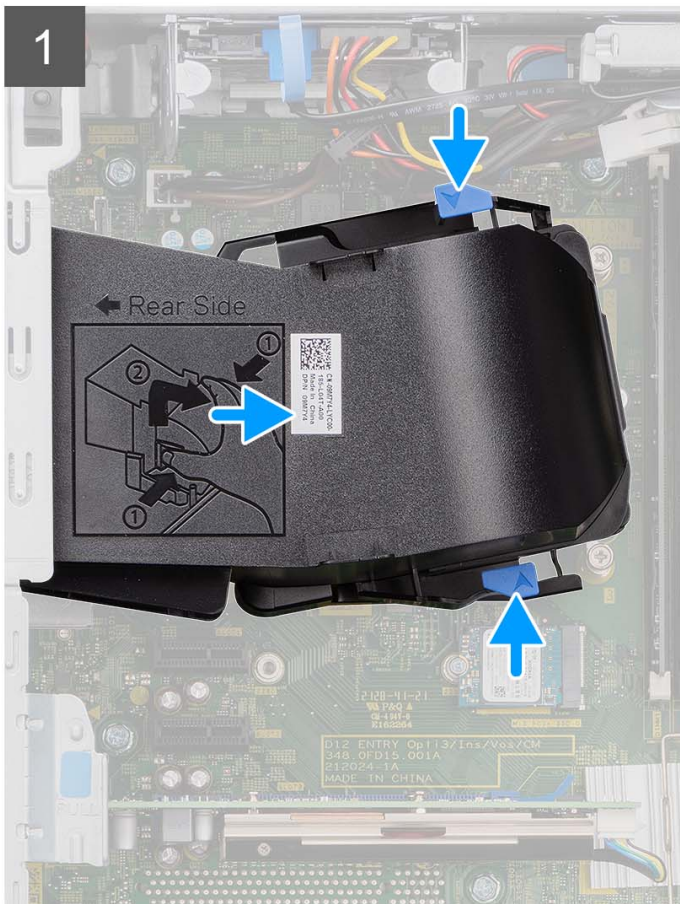

Steps

1. Press the retention tabs on both sides of the fan duct to release it.
2. Pull and remove the fan duct from the computer.

Installing the fan duct

Prerequisites

If you are replacing a component, remove the existing component before performing the installation procedure.

About this task

The following image indicates the location of the fan duct and provides a visual representation of the installation procedure.

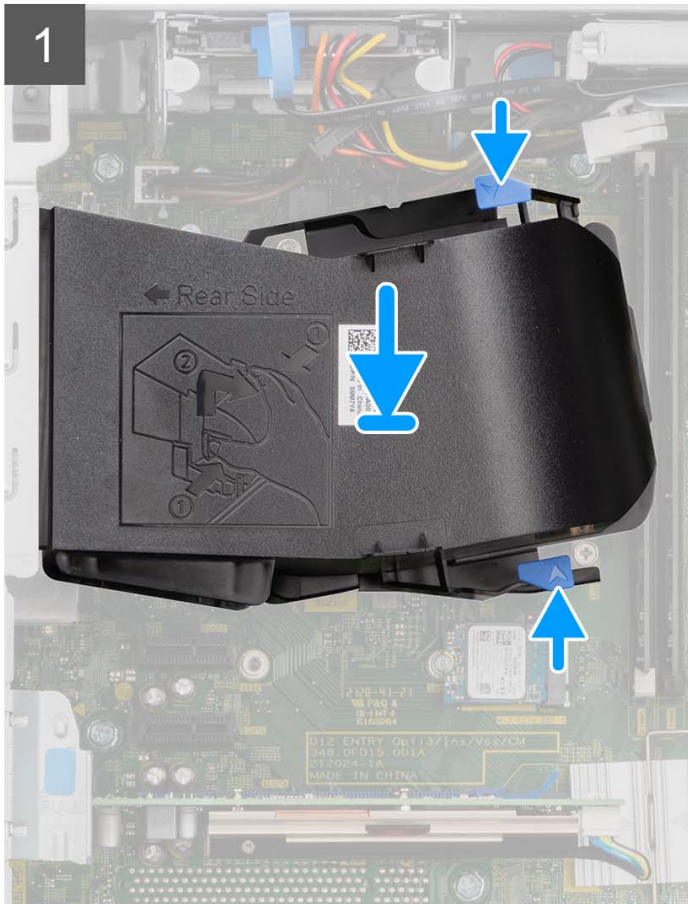

Steps

1. Position the fan duct to align it with the slots on the computer chassis.
2. Press the fan duct until it clicks into place.

Next steps

1. Install the [side cover](#).
2. Follow the procedure in [after working inside your computer](#).

Processor fan and heat-sink assembly

Removing the processor fan and heat-sink assembly

Prerequisites

1. Follow the procedure in [before working inside your computer](#).

 **WARNING:** The heat sink may become hot during normal operation. Allow sufficient time for the heat sink to cool before you touch it.

 **CAUTION:** For maximum cooling of the processor, do not touch the heat transfer areas on the heat sink. The oils in your skin can reduce the heat transfer capability of the thermal grease.

2. Remove the [side cover](#).
3. Remove the [fan duct](#).

About this task

The following images indicate the location of the processor fan and heat-sink assembly and provide a visual representation of the removal procedure.

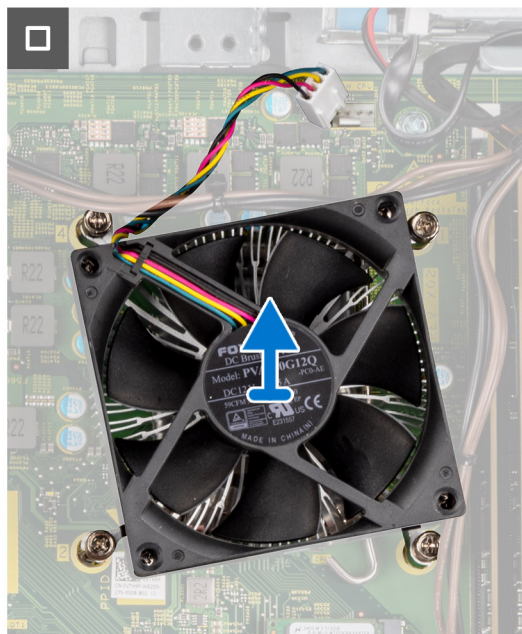
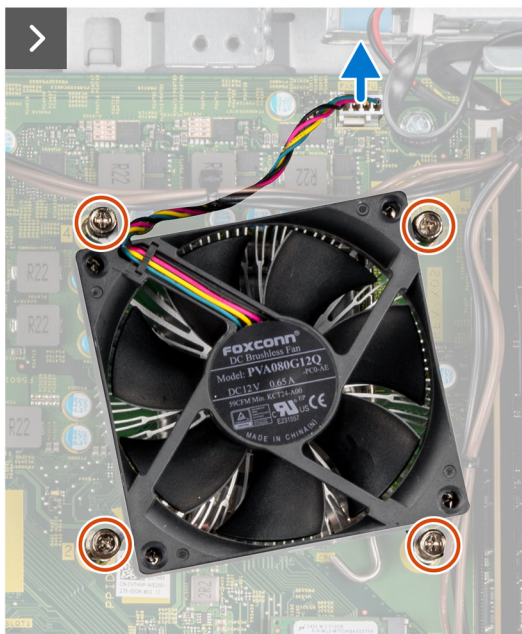

Steps

1. Disconnect the processor-fan cable from the connector on the system board.
2. In the reverse sequential order (4->3->2->1), loosen the four captive screws that secure the processor fan and heat-sink assembly to the system board.
3. Lift the processor fan and heat-sink assembly from the system board.

Installing the processor fan and heat-sink assembly

Prerequisites

If you are replacing a component, remove the existing component before performing the installation procedure.

NOTE: If either the processor or the heat sink is replaced, use the thermal grease that is provided in the kit to ensure that thermal conductivity is achieved.

About this task

The following image indicates the location of the processor fan and heat-sink and provides a visual representation of the installation procedure.

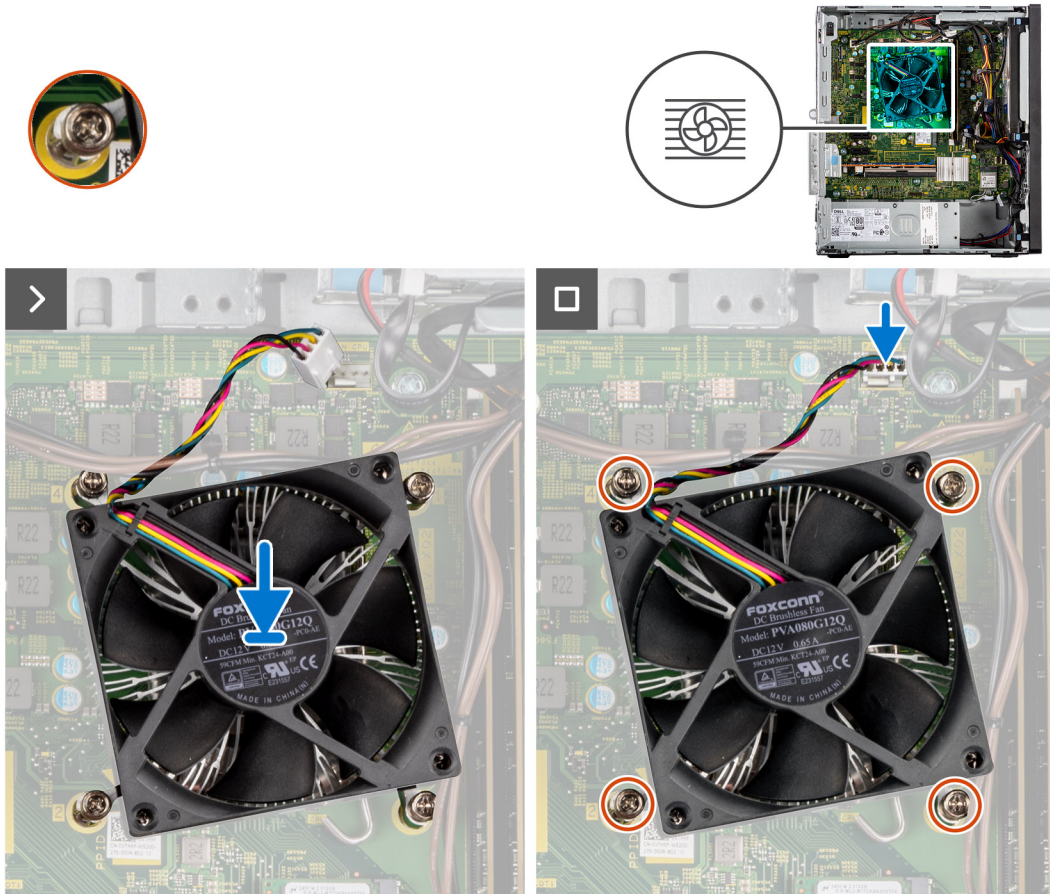

Steps

1. Align the screws on the processor fan and heat-sink assembly with the screw holders on the system board and place the processor fan and heat-sink assembly on the processor.

NOTE: Ensure that the triangle mark is directed towards the rear side of the computer.

2. In the sequential order (1->2->3->4), tighten the captive screws to secure the processor fan and heat-sink assembly to the system board.

NOTE: Tighten the screws in a sequential order (1,2,3,4) as printed on the heat-sink assembly.

3. Connect the processor-fan cable to the connector on the system board.

Next steps

1. Install the [fan duct](#).
2. Install the [side cover](#).

3. Follow the procedure in [after working inside your computer](#).

Processor

Removing the processor

Prerequisites

1. Follow the procedure in [before working inside your computer](#).
2. Remove the [side cover](#).
3. Remove the [fan duct](#).
4. Remove the [processor fan and heat-sink assembly](#).

NOTE: The processor might still be hot after the computer is shut down. Allow the processor to cool down before removing it.

About this task

The following images indicate the location of the processor and provide a visual representation of the removal procedure.

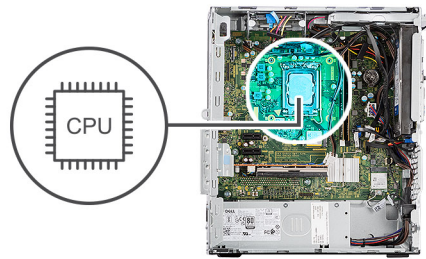

Steps

1. Press down and push the release lever away from the processor to release it from the securing tab.
2. Lift the lever upward to lift the processor cover.

CAUTION: When removing the processor, do not touch any of the pins inside the socket or allow any objects to fall on the pins in the socket.

3. Gently lift the processor from the processor socket.

Installing the processor

Prerequisites

If you are replacing a component, remove the existing component before performing the installation procedure.

About this task

The following image indicates the location of the processor and provides a visual representation of the installation procedure.

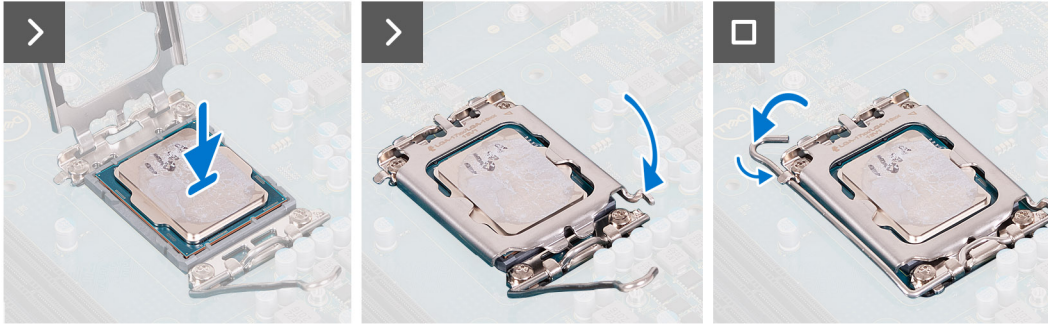
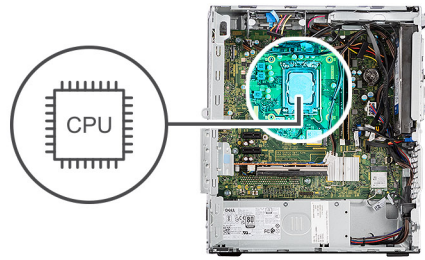

Steps

1. Ensure that the release lever on the processor socket is fully extended in the open position.
2. Align the notches on the processor with the tabs on the processor socket and place the processor in the processor socket.
i **NOTE:** The pin-1 corner of the processor has a triangle that aligns with the triangle on the pin-1 corner on the processor socket. When the processor is properly seated, all four corners are aligned at the same height. If one or more corners of the processor are higher than the others, the processor is not seated properly.
3. When the processor is fully seated in the socket, pivot the release-lever down and place it under the tab on the processor cover.

Next steps

1. Install the [processor fan and heat-sink assembly](#).
2. Install the [fan duct](#).
3. Install the [side cover](#).
4. Follow the procedure in [after working inside your computer](#).

Front Input/Output bracket

Removing the front Input/Output bracket

Prerequisites

1. Follow the procedure in [before working inside your computer](#).
2. Remove the [side cover](#).
3. Remove the [front bezel](#).

About this task

The following images indicate the location of the power button and provide a visual representation of the removal procedure.



2x
#6-32

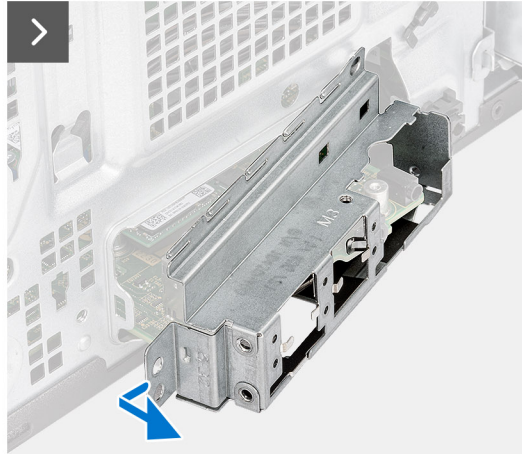
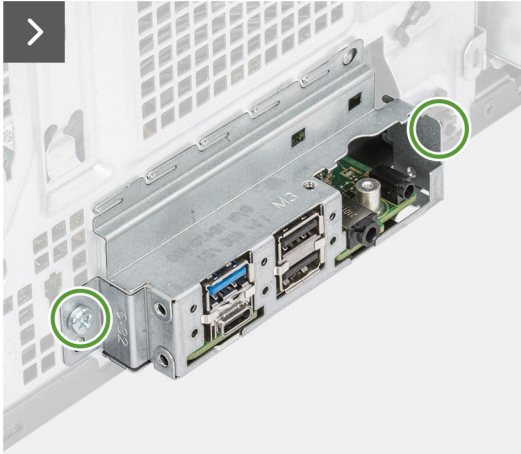

Steps

1. Remove the two (#6-32) screws that secure the front input/output bracket.
2. Lift the front input/output bracket from the chassis.

Installing the front input/output bracket

Prerequisites

If you are replacing a component, remove the existing component before performing the installation procedure.

About this task

The following images indicate the location of the front input/output bracket and provide a visual representation of the installation procedure.



2x
#6-32

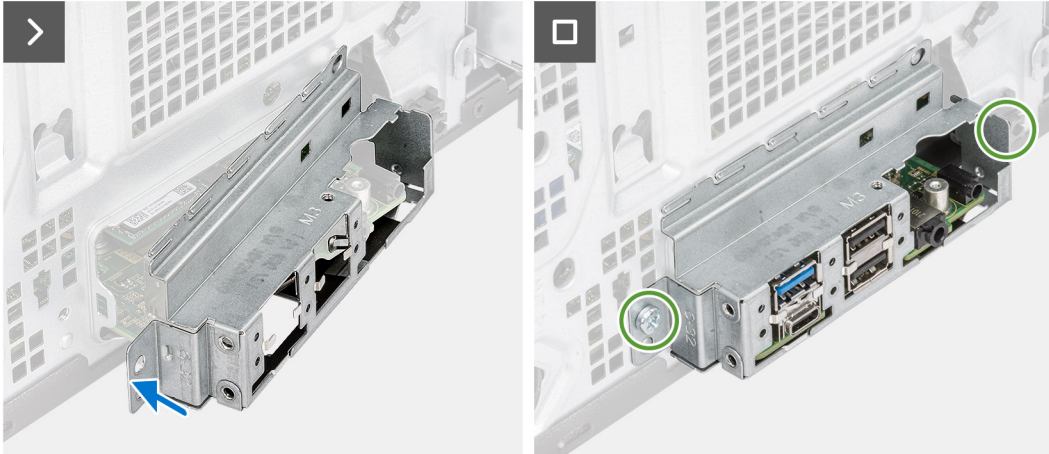
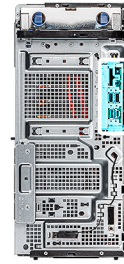

Steps

1. Align and place the front input/output bracket with the slot on the chassis.
2. Replace the two (#6-32) screws that secure the front input/output bracket to the chassis.

Next steps

1. Install the [front bezel](#).
2. Install the [side cover](#).
3. Follow the procedure in [after working inside your computer](#).

Power button

Removing the power button

Prerequisites

1. Follow the procedure in [before working inside your computer](#).
2. Remove the [side cover](#).
3. Remove the [front bezel](#).
4. Remove the [front input/output bracket](#).

About this task

The following images indicate the location of the power button and provide a visual representation of the removal procedure.

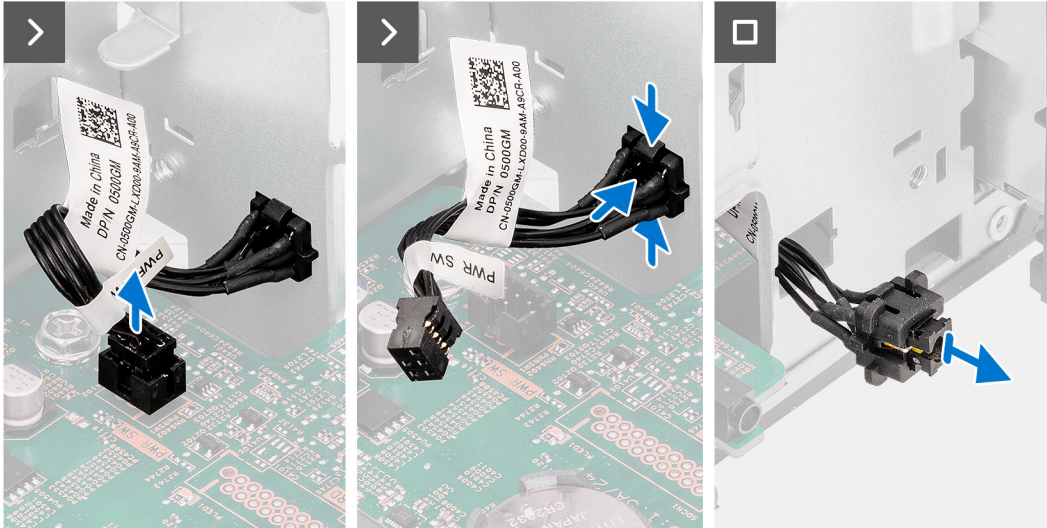

Steps

1. Disconnect the power-button cable from the connector on the system board.
2. Press the release tabs on the power-button head and slide the power-button cable out from the front-side chassis of the computer.
3. Pull the power-button cable out from the computer.

Installing the power button

Prerequisites

If you are replacing a component, remove the existing component before performing the installation procedure.

About this task

The following images indicate the location of the power button and provide a visual representation of the installation procedure.

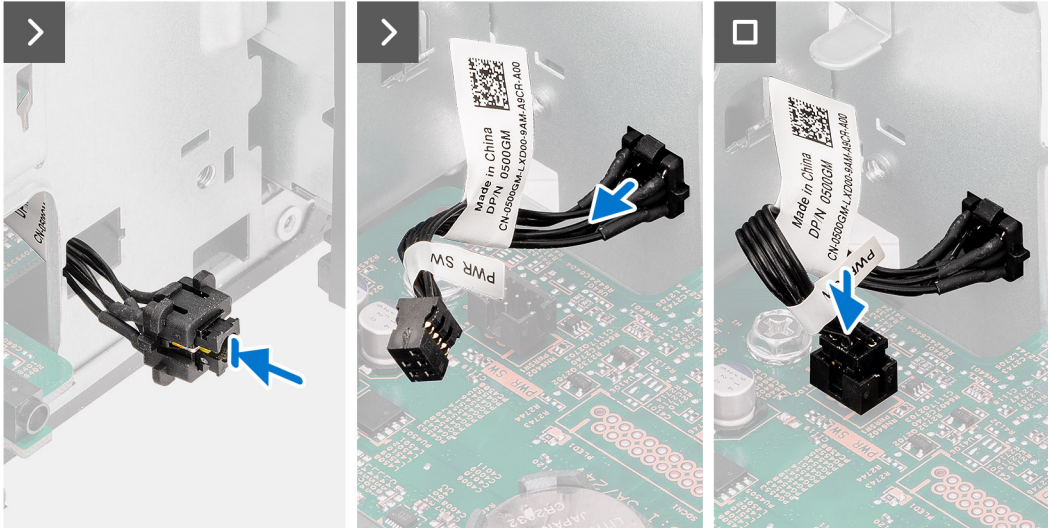

Steps

1. Insert the power-button cable into the slot from the front-side of the computer, and press the power-button head until it clicks into the place in the chassis.
2. Align and connect the power-button cable to the connector on the system board.

Next steps

1. Install the [front input/output bracket](#).
2. Install the [front bezel](#).
3. Install the [side cover](#).
4. Follow the procedure in [after working inside your computer](#).

Wireless antenna kit

Internal antenna kit

Removing the internal antenna kit

CAUTION: The information in this section is intended for authorized service technicians only.

Prerequisites

1. Follow the procedure in [Before working inside your computer](#).
2. Remove the [side cover](#).
3. Remove the [front bezel](#).

About this task

The following images indicate the location of the internal antenna and provides a visual representation of the removal procedure.



2x
M3x5

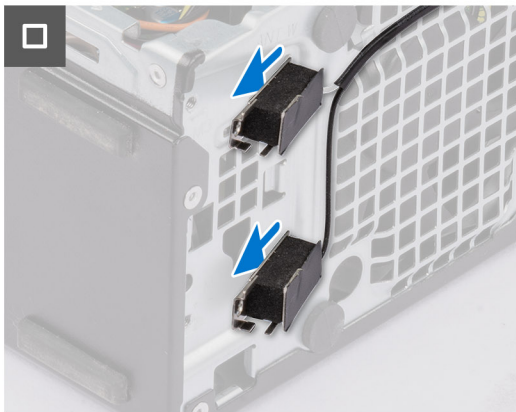
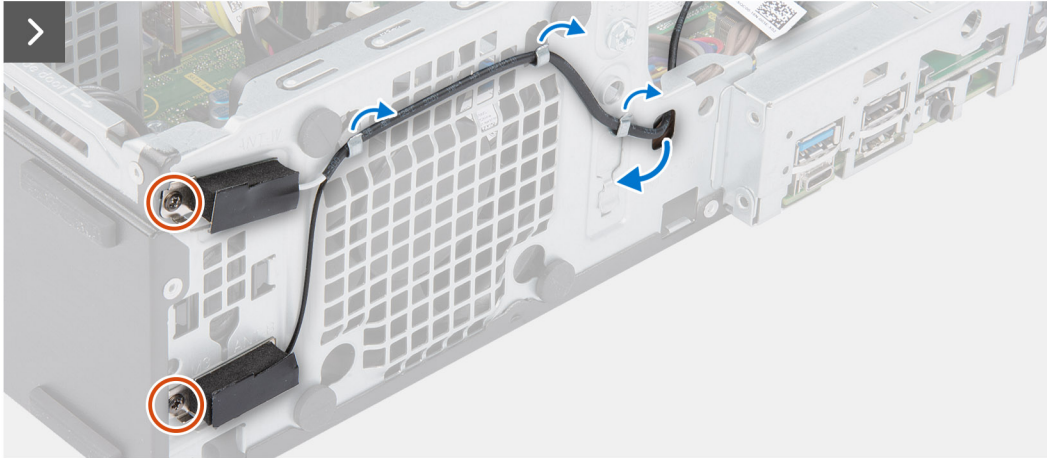

Steps

1. Remove the (M2x3.5) screw that secures the wireless card bracket to the system board.
2. Slide and lift the wireless card bracket away from the wireless card.
3. Disconnect the antenna cables from the connectors on the wireless card.
4. Gently pull the internal antenna cable out from the hole on the chassis.
5. Remove the internal antenna cable from the routing guides on the chassis
6. Remove the two screws (M3x3) that secure the internal antenna to the chassis.
7. Remove the internal antenna assembly from the chassis.

Installing the internal antenna kit

CAUTION: The information in this section is intended for authorized service technicians only.

Prerequisites

If you are replacing a component, remove the existing component before performing the installation procedure.

About this task

The following images indicate the location of the internal antenna and provides a visual representation of the installation procedure.

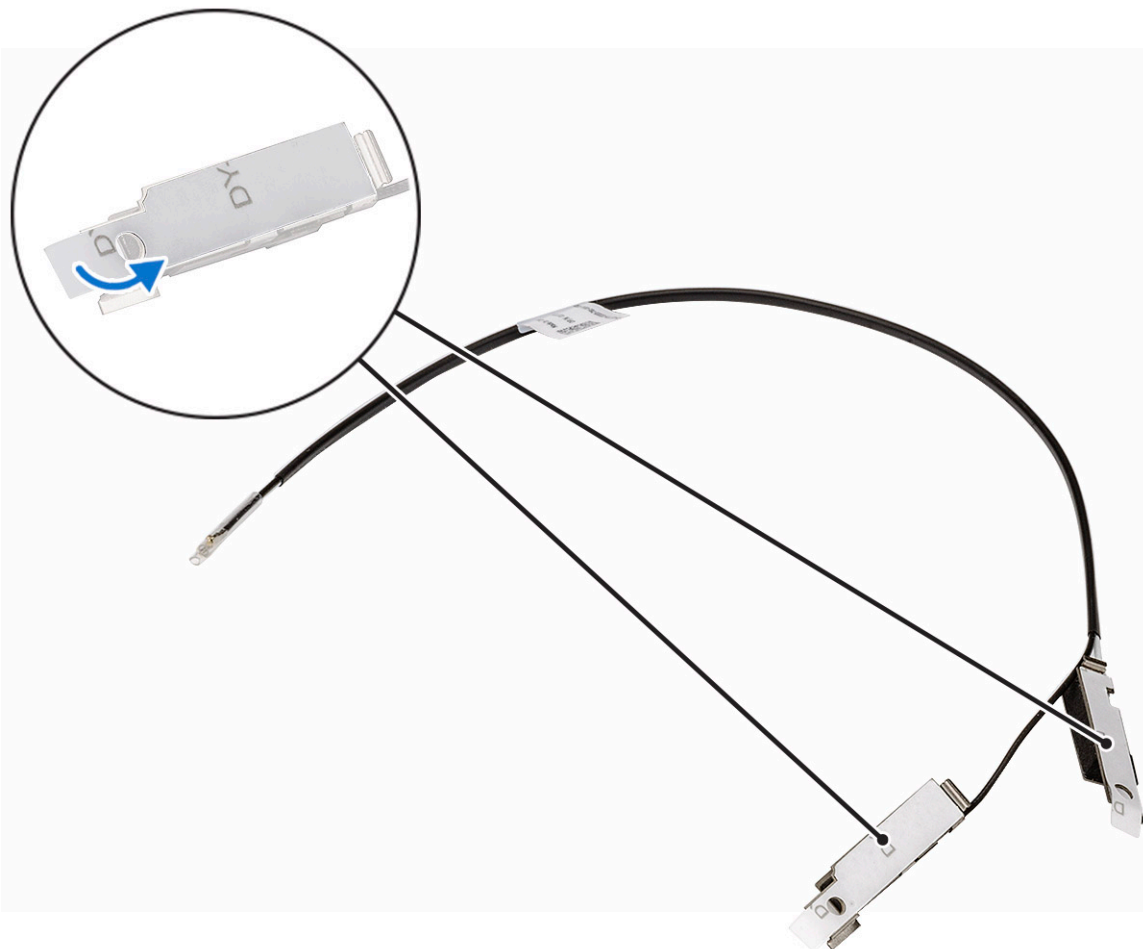



2x
M3x5

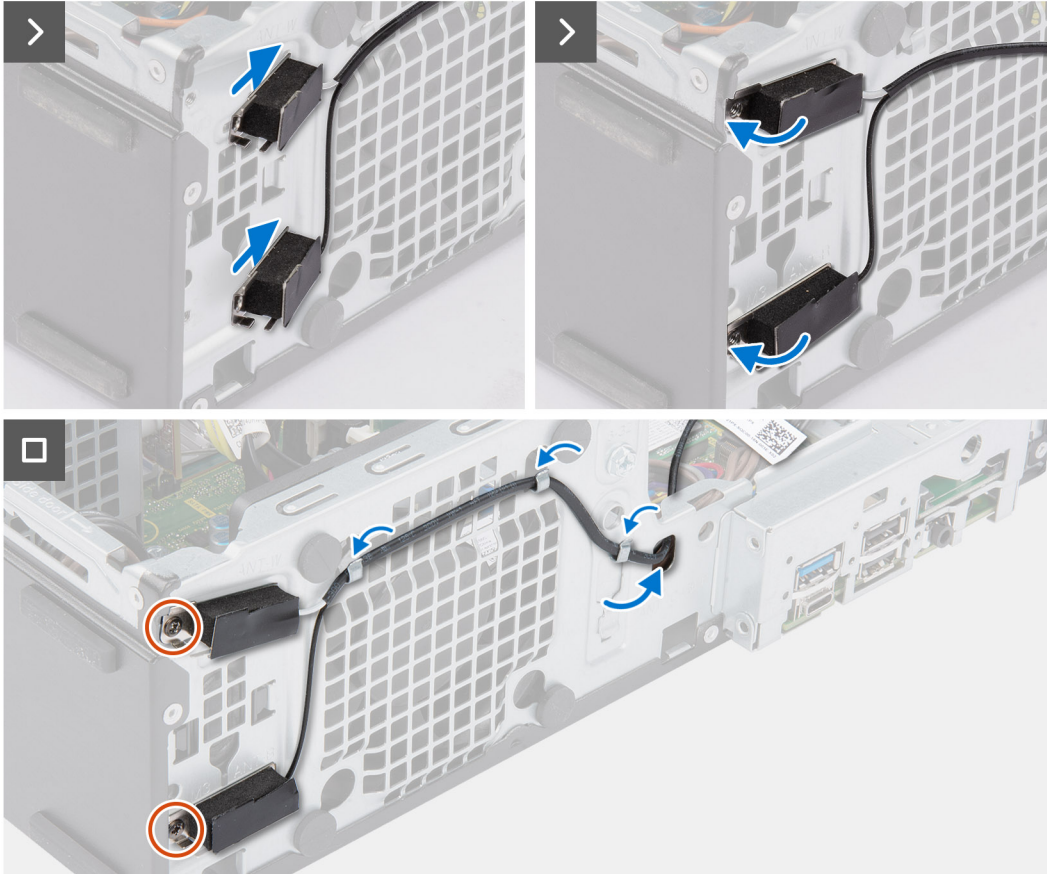

Steps

1. Peel away the protective tape from the back of the antennas.
2. Insert the antennas into the slots on the chassis.
The antennas should be installed on the appropriate slots on the chassis.

Table 25. Antenna-cable color scheme

CHASSIS LABEL	ANTENNA-CABLE COLOR
ANT-W	White
ANT-B	Black

3. Replace the two screws (M3x3) that secures the internal antennas to the chassis.
4. Route the internal antenna cable through the routing guide on the chassis.
5. Route the internal antenna cable through the hole on the chassis.
6. Connect the antenna cables to the connectors on the wireless card.
7. Align and place the wireless card bracket on the wireless card
8. Replace the single screw (M2x3.5) that secures the internal antennas to the chassis.

Next steps

1. Install the [front bezel](#).
2. Install the [side cover](#).
3. Follow the procedure in [after working inside your computer](#).

External SMA antenna kit

Removing optional SMA module

Prerequisites

1. Follow the procedure in [before working inside your computer](#).
2. Remove the [side cover](#).
3. Remove the [wireless card](#).

About this task

The following images indicate the location of the optional SMA module and provide a visual representation of the removal procedure.

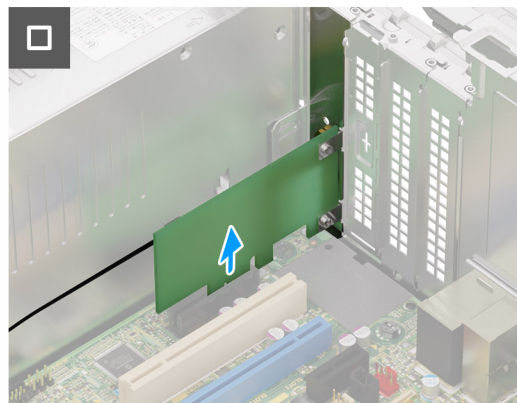
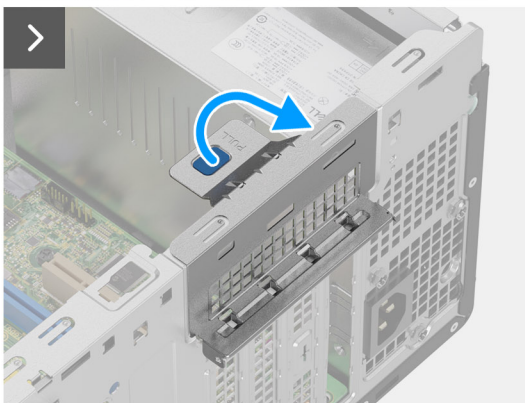
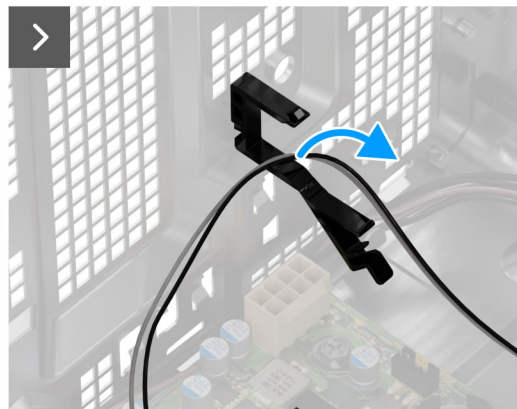
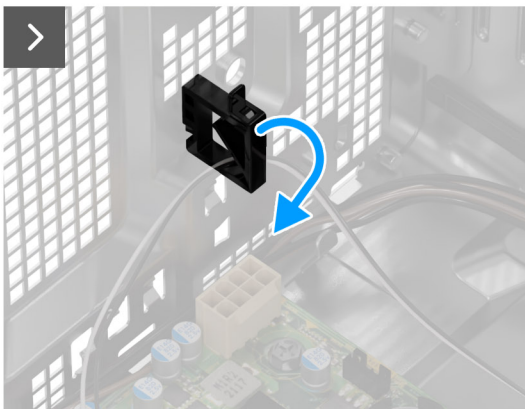
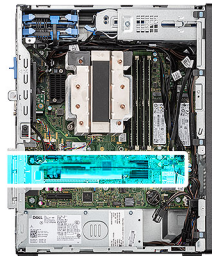

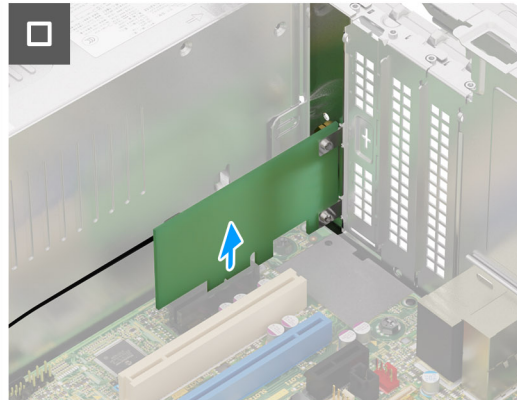
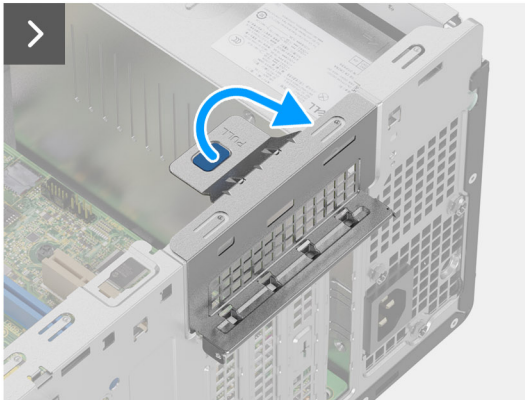
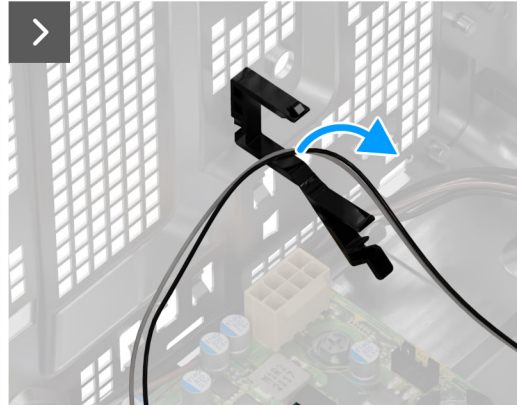
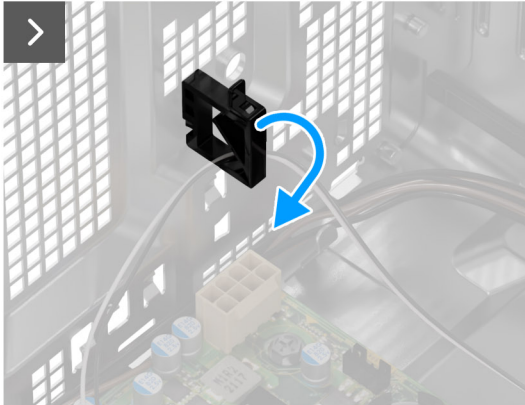

Steps

1. Open cable holder and unroute the SMA module cable from the cable holder on the chassis.
2. Lift the pull tab to open the PCIe door.
3. Hold and remove the SMA module from its connector on the system board.

Installing optional SMA module

Prerequisites

If you are replacing a component, remove the existing component before performing the installation procedure.

About this task

The following images indicate the location of the optional SMA module and provide a visual representation of the installation procedure.

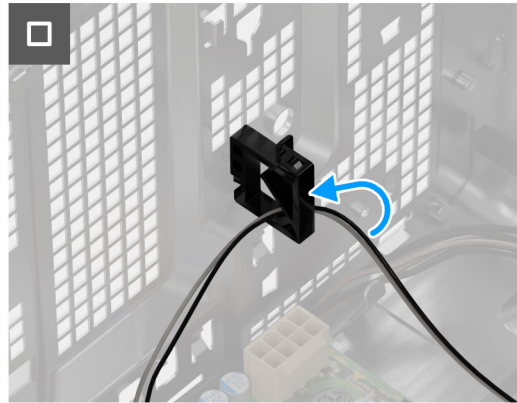
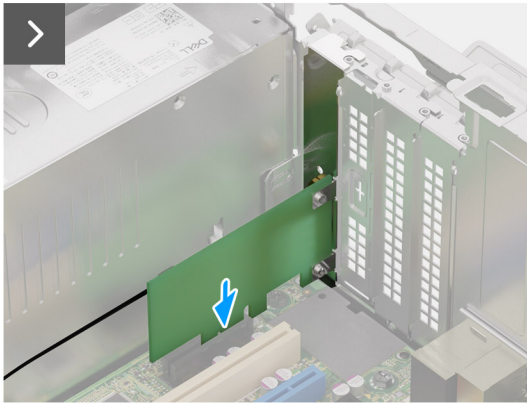
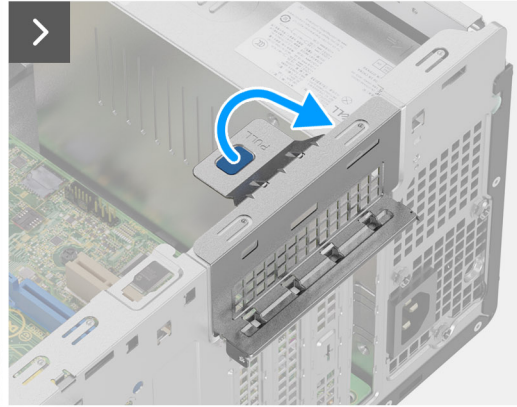
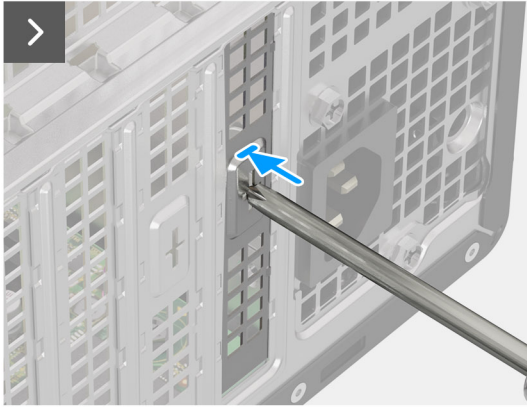
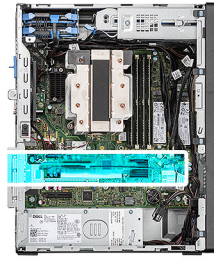

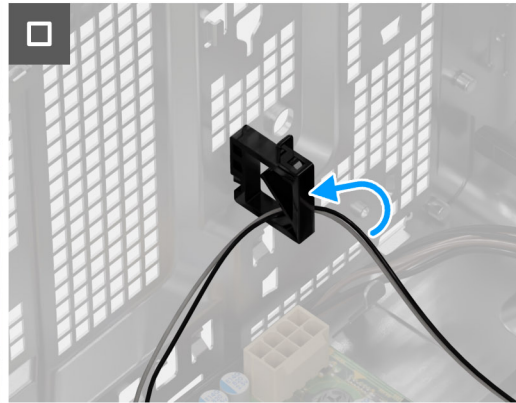
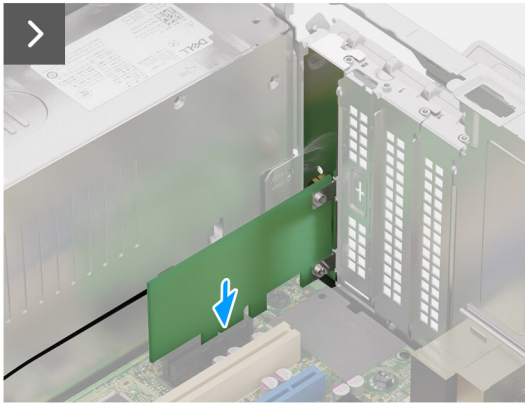
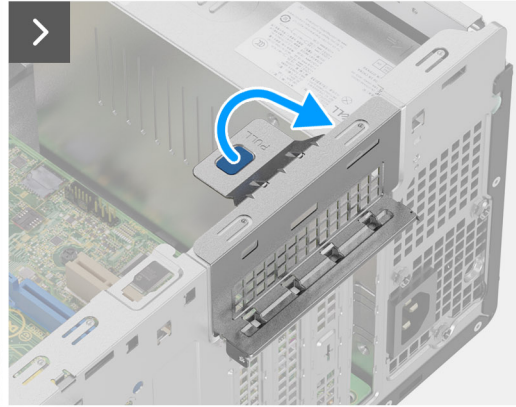
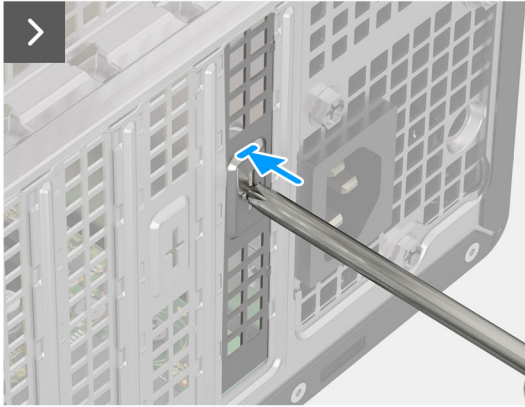

Steps

1. To remove the PCIe dummy bracket, insert a flat-head screwdriver in the hole of the bracket, push the bracket to release it, and then lift the bracket out of the system.
2. Lift the pull tab to open the PCIe door.
3. Insert the optional SMA module into its slot on the system board.
4. Route the SMA module cable through the cable holder on the chassis.
5. Close the cable holder to secure the SMA module cable in place.

Next steps

1. Install the [wireless card](#).
2. Install the [side cover](#).
3. Follow the procedure in [after working inside your computer](#).

Optional Input/Output modules

Serial module

Removing the optional serial module

Prerequisites

1. Follow the procedure in [Before working inside your computer](#).
2. Remove the [side cover](#).

About this task

The following images indicate the location of the optional serial module and provides a visual representation of the removal procedure.



2x
4-40x6.5

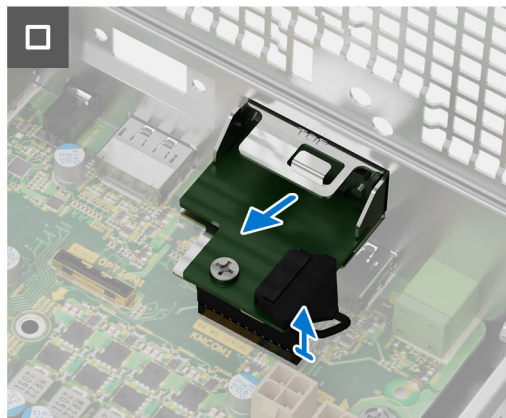
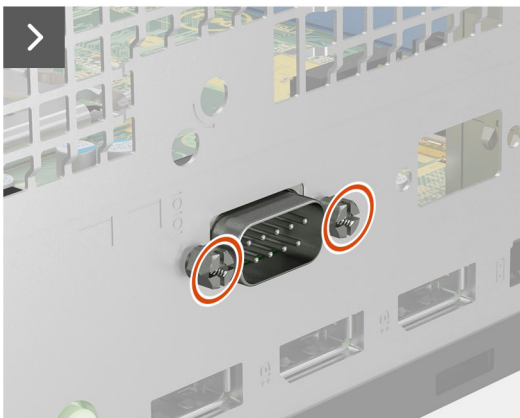

Steps

1. Remove the two (4-40x6.5) screws that secure the optional serial module to the chassis.
2. Disconnect the optional serial module cable from the connector on the system board.
3. Lift the optional serial module off the system board.

Installing the serial module

Prerequisites

If you are replacing a component, remove the existing component before performing the installation procedure.

About this task

The following images indicate the location of the serial module and provides a visual representation of the installation procedure.



2x
4-40x6.5

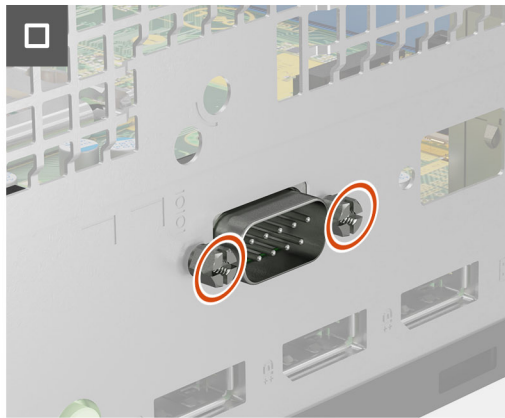
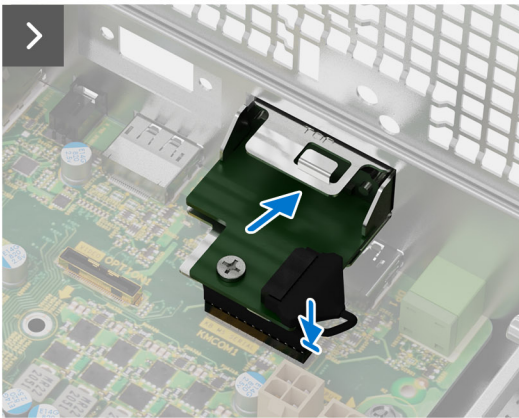
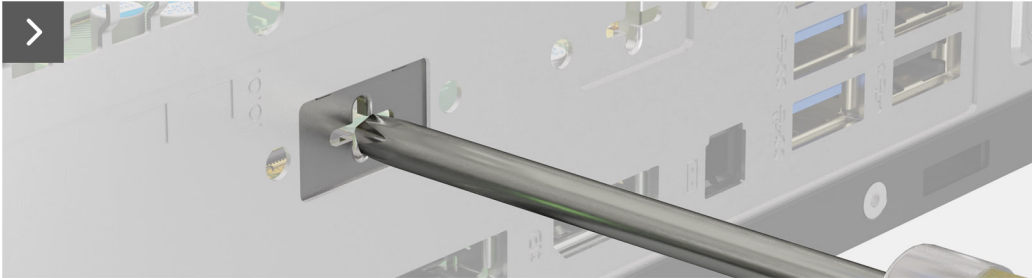

Steps

1. Using a screwdriver, remove the serial module cover from the chassis.
NOTE: This step is applicable only when the serial module is being installed for the first time.
2. Connect the serial-module cable to the connector (KB_MS_SERIAL) on the system board
3. Insert the serial module into the slot on the chassis.
4. Replace the two (4-40x6.5) screws that secure the serial module to the chassis.

Next steps

1. Install the [side cover](#).
2. Follow the procedure in [after working inside your computer](#).

VGA module

Removing optional VGA module

Prerequisites

1. Follow the procedure in [before working inside your computer](#).
2. Remove the [side cover](#).

About this task

The following images indicate the location of the optional VGA module and provide a visual representation of the removal procedure.



2x
4-40x6.5

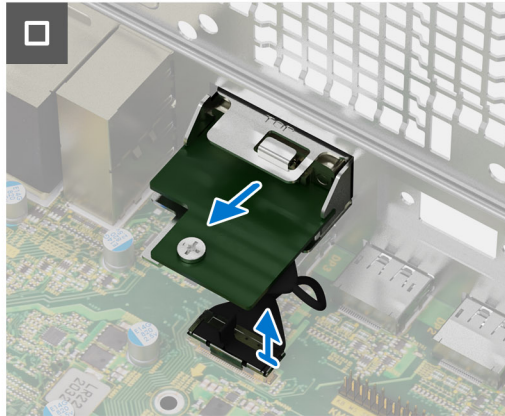
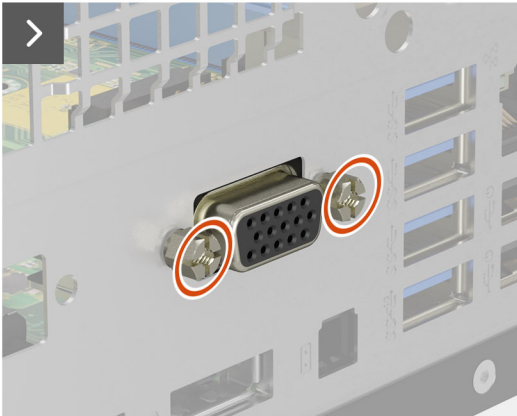

Steps

1. Remove the two (4-40x6.5) screws that secure the optional VGA module to the computer chassis.
2. Disconnect the VGA module cable from the connector on the system board.
3. Remove the VGA module from the computer.

Installing optional VGA module

Prerequisites

If you are replacing a component, remove the existing component before performing the installation procedure.

About this task

The following images indicate the location of the optional VGA module and provide a visual representation of the installation procedure.



2x
4-40x6.5

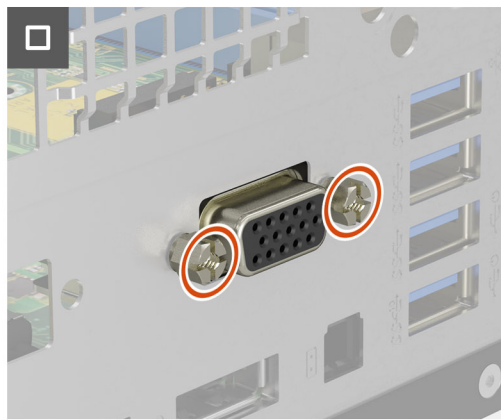
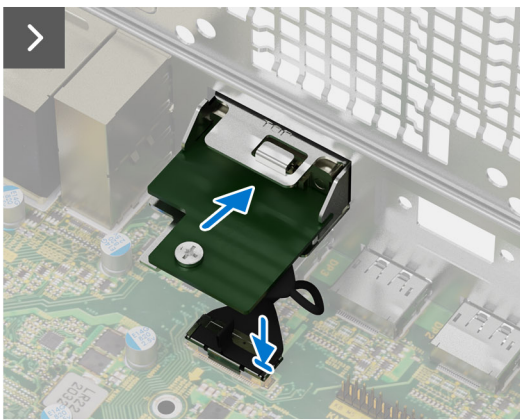
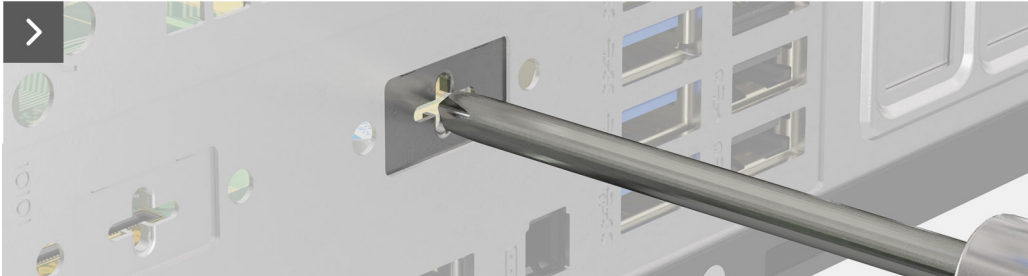
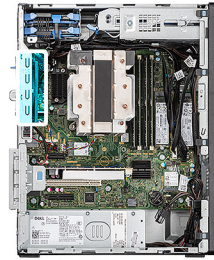

Steps

1. To remove the dummy metal bracket, insert a star-head screwdriver in the hole of the bracket, push the bracket to release the bracket, and then lift the bracket out from the system.

NOTE: Applies if you are upgrading the system that did not have these optional modules.

2. Insert the optional VGA module into its slot from the inside of your computer.
3. Connect the VGA module cable to the connector on the system board .
4. Replace the two (4-40x6.5) screws to secure the optional VGA module to the system.

Next steps

1. Install the [side cover](#).
2. Follow the procedure in [after working inside your computer](#).

DP module

Removing optional DisplayPort module

Prerequisites

1. Follow the procedure in [before working inside your computer](#).
2. Remove the [side cover](#).

About this task

The following images indicate the location of the optional DisplayPort module and provide a visual representation of the removal procedure.



2x
M3x3

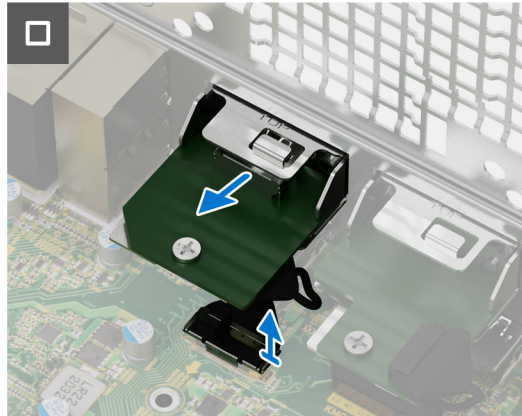
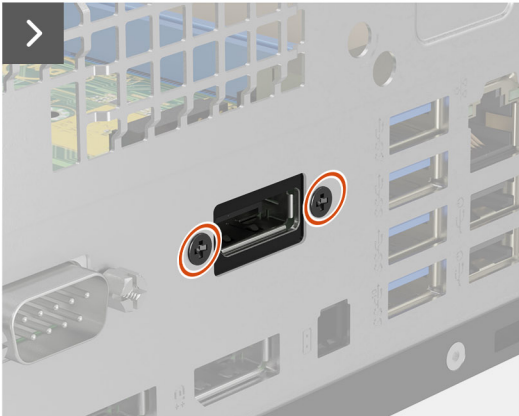

Steps

1. Remove the two (M3X3) screws that secure the optional DisplayPort module to the computer chassis.
2. Disconnect the DisplayPort module cable from the connector on the system board.
3. Remove the DisplayPort module from the computer.

Installing optional DisplayPort module

Prerequisites

If you are replacing a component, remove the existing component before performing the installation procedure.

About this task

The following images indicate the location of the optional DisplayPort module and provide a visual representation of the installation procedure.



2x
M3x3

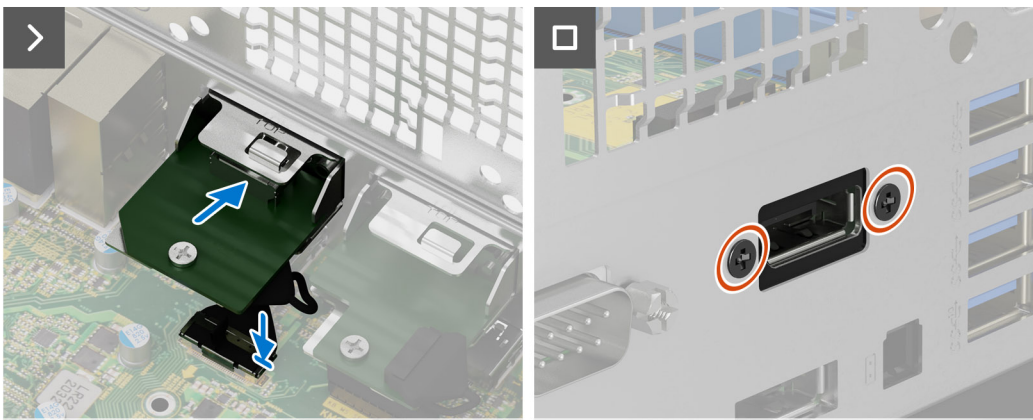
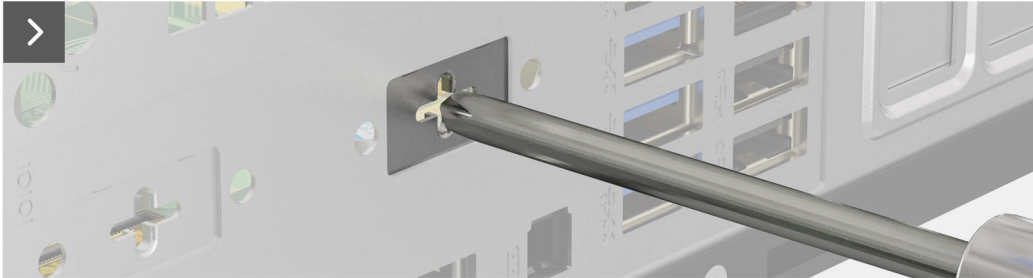

Steps

1. To remove the dummy metal bracket, insert a star-head screwdriver in the hole of the bracket, push the bracket to release the bracket, and then lift the bracket out from the system.

NOTE: Applies if you are upgrading the system that did not have these optional modules.

2. Insert the optional DisplayPort module into its slot from the inside of your computer.
3. Connect the DisplayPort module cable to the connector on the system board .
4. Replace the two (M3X3) screws to secure the optional DisplayPort module to the system.

Next steps

1. Install the [side cover](#).
2. Follow the procedure in [after working inside your computer](#).

HDMI module

Removing optional HDMI module

Prerequisites

1. Follow the procedure in [before working inside your computer](#).
2. Remove the [side cover](#).

About this task

The following images indicate the location of the optional HDMI module and provide a visual representation of the removal procedure.



2x
M3x3

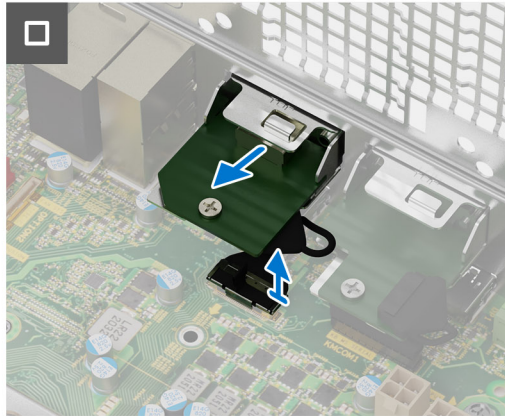
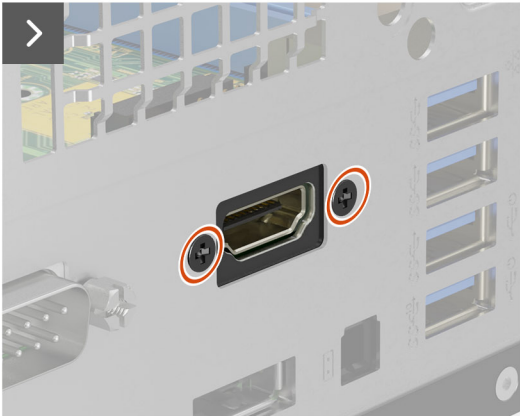

Steps

1. Remove the two (M3X3) screws that secure the optional HDMI module to the computer chassis.
2. Disconnect the HDMI module cable from the connector on the system board.
3. Remove the HDMI module from the computer.

Installing optional HDMI module

Prerequisites

If you are replacing a component, remove the existing component before performing the installation procedure.

About this task

The following images indicate the location of the optional HDMI module and provide a visual representation of the installation procedure.



2x
M3x3

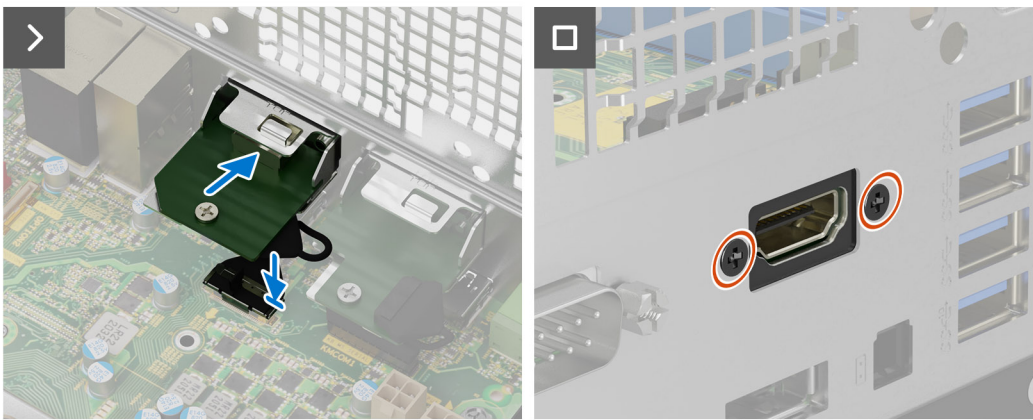
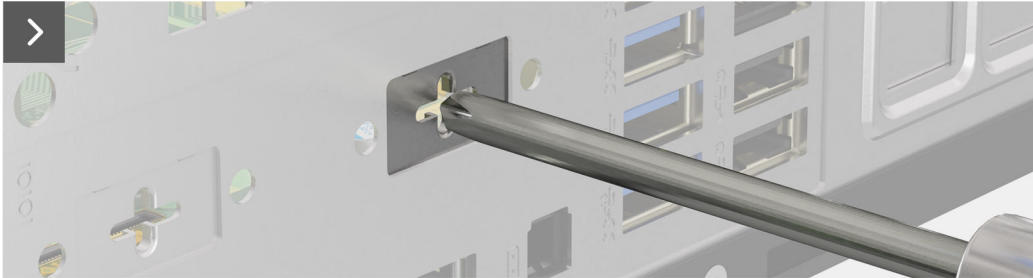

Steps

1. To remove the dummy metal bracket, insert a star-head screwdriver in the hole of the bracket, push the bracket to release the bracket, and then lift the bracket out from the system.

NOTE: Applies if you are upgrading the system that did not have these optional modules.

2. Insert the optional HDMI module into its slot from the inside of your computer.
3. Connect the HDMI module cable to the connector on the system board .
4. Replace the two (M3X3) screws to secure the optional HDMI module to the system.

Next steps

1. Install the [side cover](#).
2. Follow the procedure in [after working inside your computer](#).

System board

Removing the system board

Prerequisites

1. Follow the procedure in [before working inside your computer](#).

NOTE: Your computer's Service Tag is stored in the system board. You must enter the Service Tag in the BIOS setup program after you replace the system board.

NOTE: Replacing the system board removes any changes that you have made to the BIOS using the BIOS setup program. You must make the appropriate changes again after you replace the system board.

NOTE: Before disconnecting the cables from the system board, note the location of the connectors so that you can reconnect the cables correctly after you replace the system board.

2. Remove the [side cover](#).
3. Remove the [front bezel](#).
4. Remove the [memory module](#).
5. Remove the [WLAN](#).
6. Remove the [M.2 2230 SSD/M.2 2280 SSD](#).
7. Remove the [3.5-inch hard drive](#).
8. Remove the [graphics card](#).
9. Remove the or [processor fan and heat-sink assembly](#).
10. Remove the [processor](#).

About this task

The following image indicates the connectors on your system board.

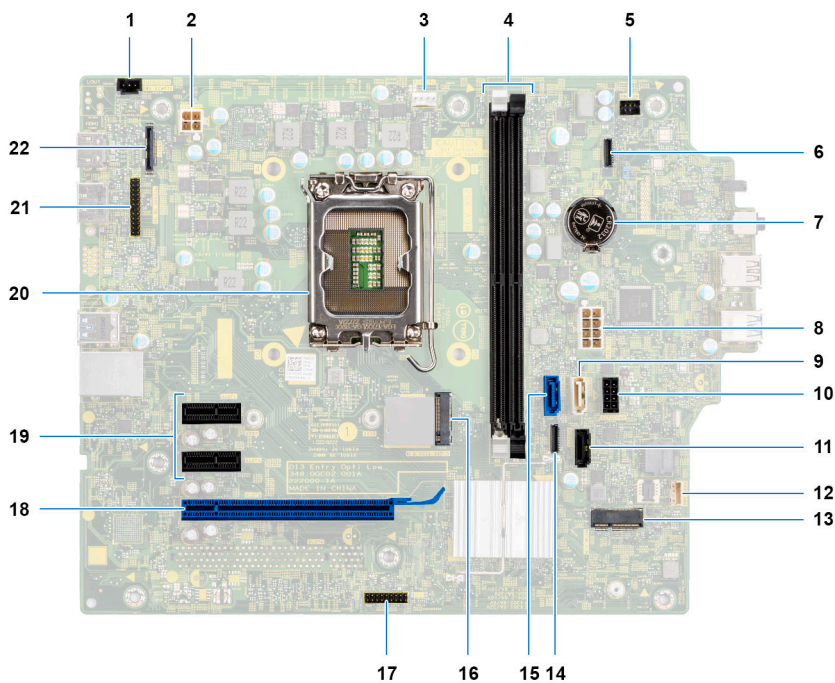

1. Intrusion switch connector
2. ATX CPU power connector
3. System fan connector
4. Memory module connectors
5. Power button connector
6. SD card reader connector
7. Coin-cell battery
8. System power connector
9. SATA3 connector (white)
10. SATA power cable connector
11. SATA 1 connector (black)
12. Internal speaker connector
13. M.2 WLAN connector
14. SATA 2 connector (black)
15. SATA0 connector (blue)
16. M.2 PCIe SSD connector

- 17. Thunderbolt header
- 18. PCIe x16 (Slot2)
- 19. PCIe x1 (Slot1/2)
- 20. Processor socket
- 21. Video connector
- 22. Type-C connector

The following images indicate the location of the system board and provide a visual representation of the removal procedure.

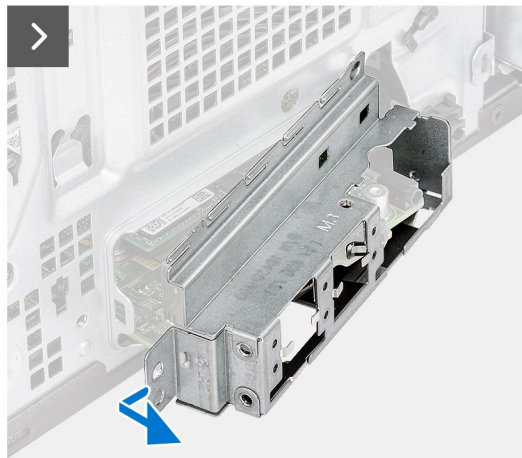
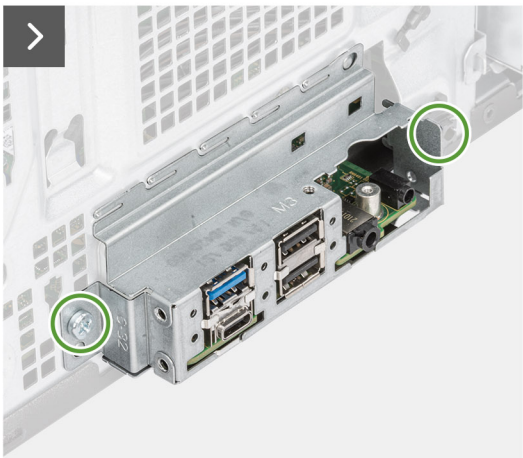

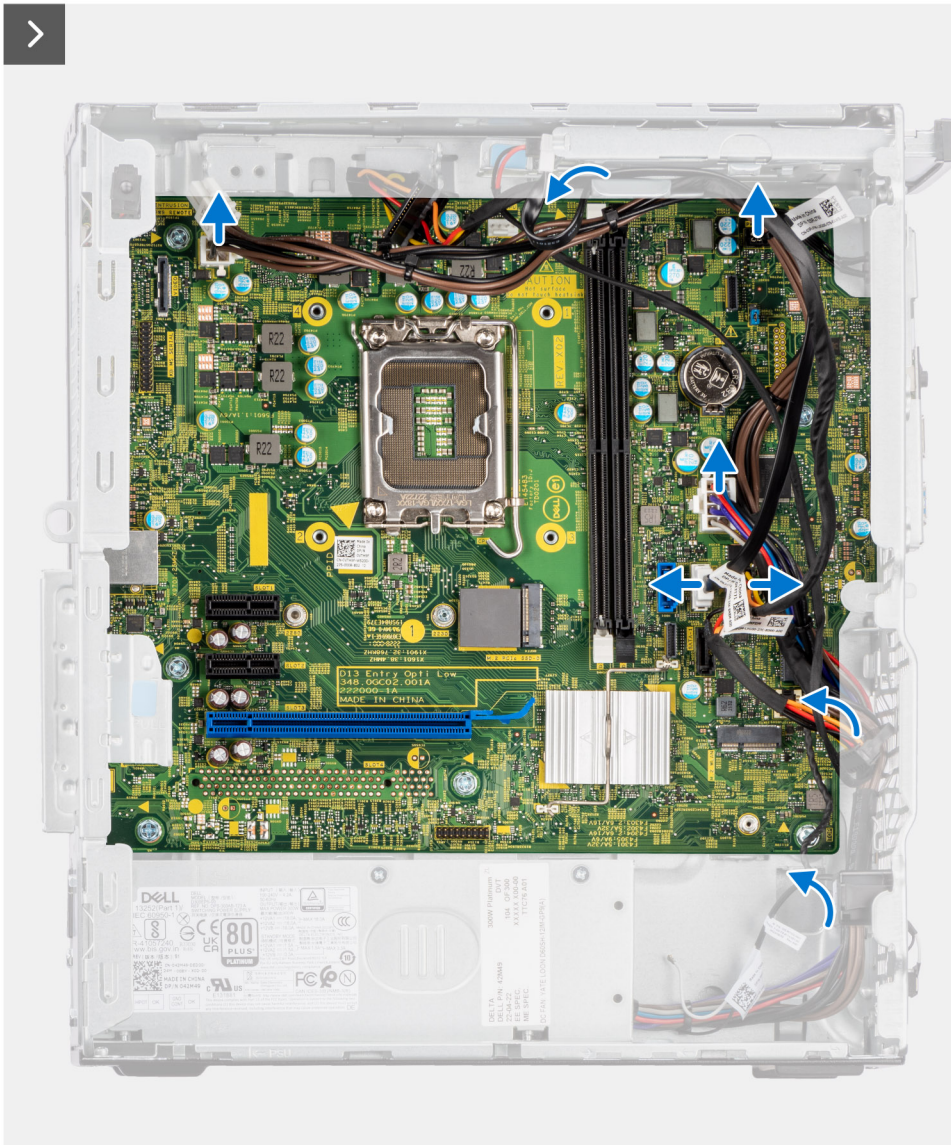

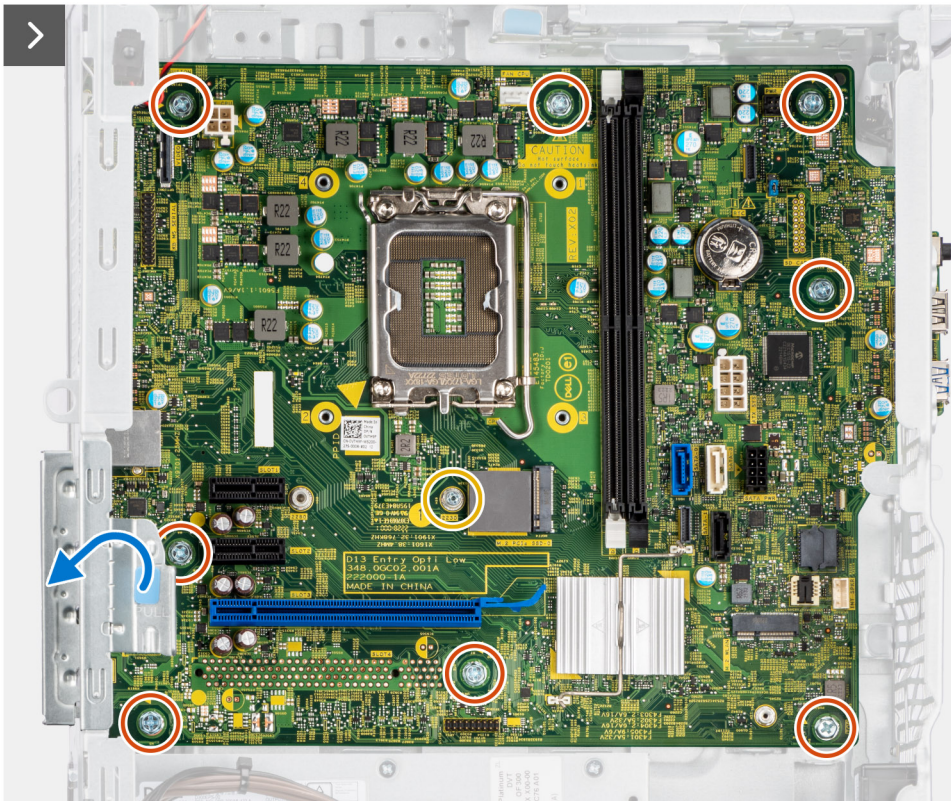

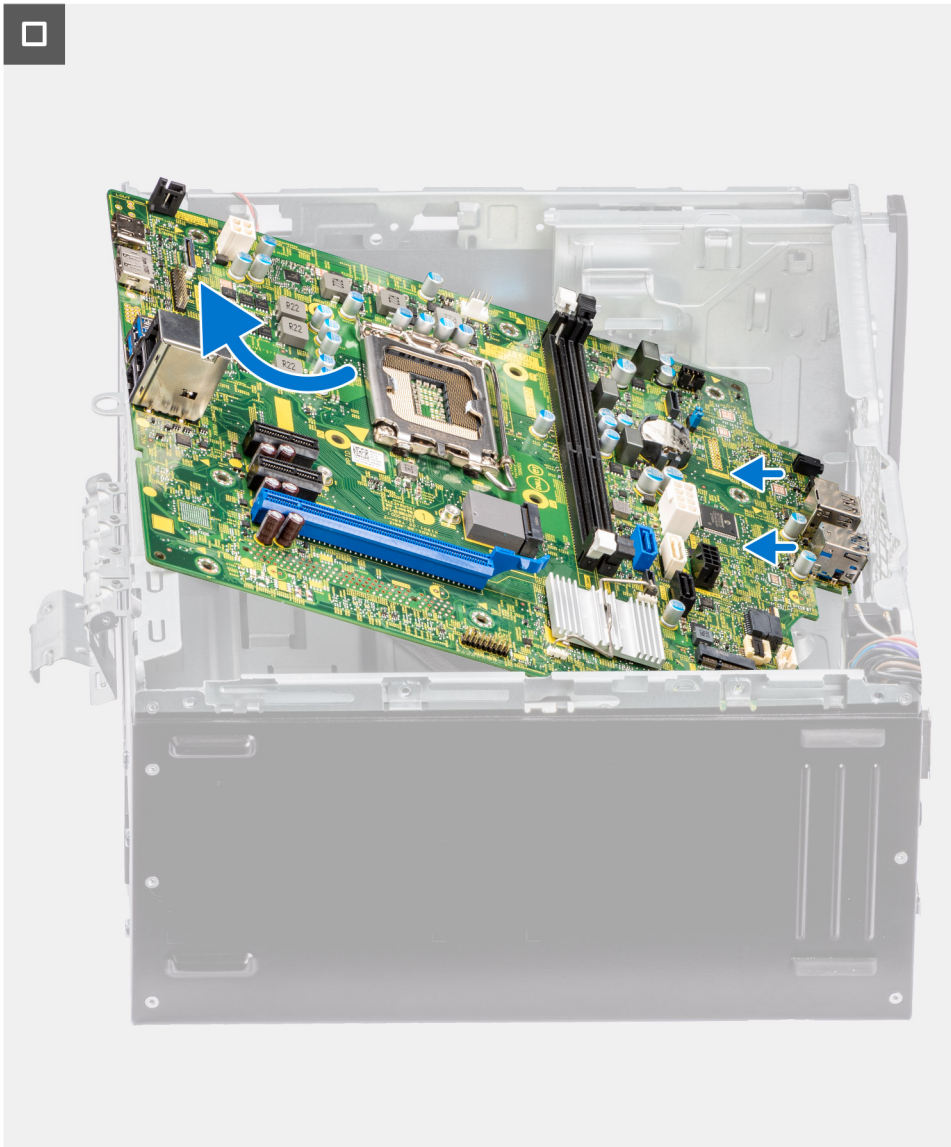

Steps

1. Remove the two (#6-32) screws that secure the front I/O-bracket to the chassis.
2. Slide and remove the front I/O-bracket from the chassis.
3. Disconnect the power and HDD cables that are connected to the system board and unroute them from the routing guides on the chassis.
4. Remove the eight (6-32) screws that secure the system board to the chassis.
5. Remove the (6-32) M.2 standoff screw that secures the system board to the chassis.
6. Lift the pull tab to open the PCIe door.
7. Lift the system board at an angle and remove the system board off the chassis.

Installing the system board

Prerequisites

If you are replacing a component, remove the existing component before performing the installation procedure.

About this task

The following image indicates the connectors on your system board.

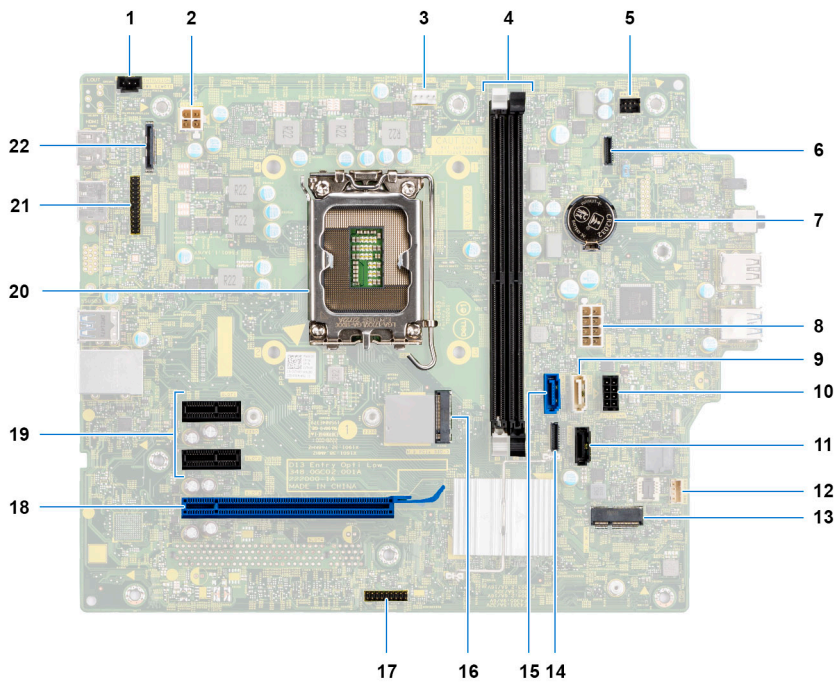

1. Intrusion switch connector
2. ATX CPU power connector
3. System fan connector
4. Memory module connectors
5. Power button connector
6. SD card reader connector
7. Coin-cell battery
8. System power connector
9. SATA3 connector (white)
10. SATA power cable connector
11. SATA 1connector (black)
12. Internal speaker connector
13. M.2 WLAN connector
14. SATA 2 connector (black)
15. SATA0 connector (blue)
16. M.2 PCIe SSD connector
17. Thunderbolt header
18. PCIe x16 (Slot2)
19. PCIe x1 (Slot1/2)
20. Processor socket
21. Video connector
22. Type-C connector

The following images indicate the location of the system board and provide a visual representation of the installation procedure.



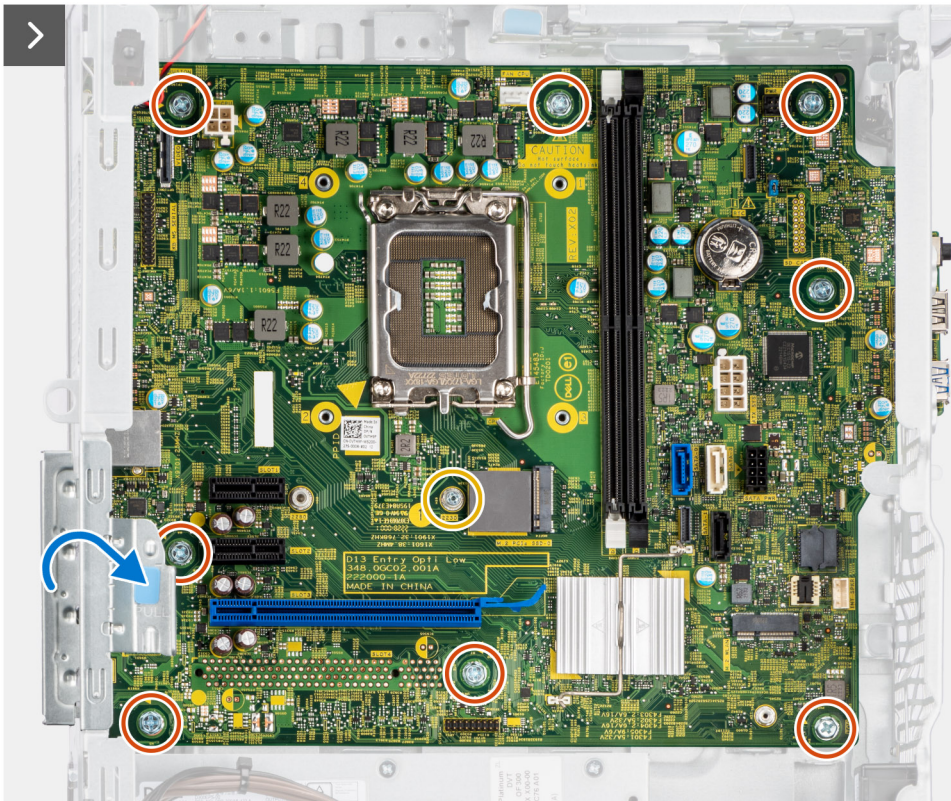

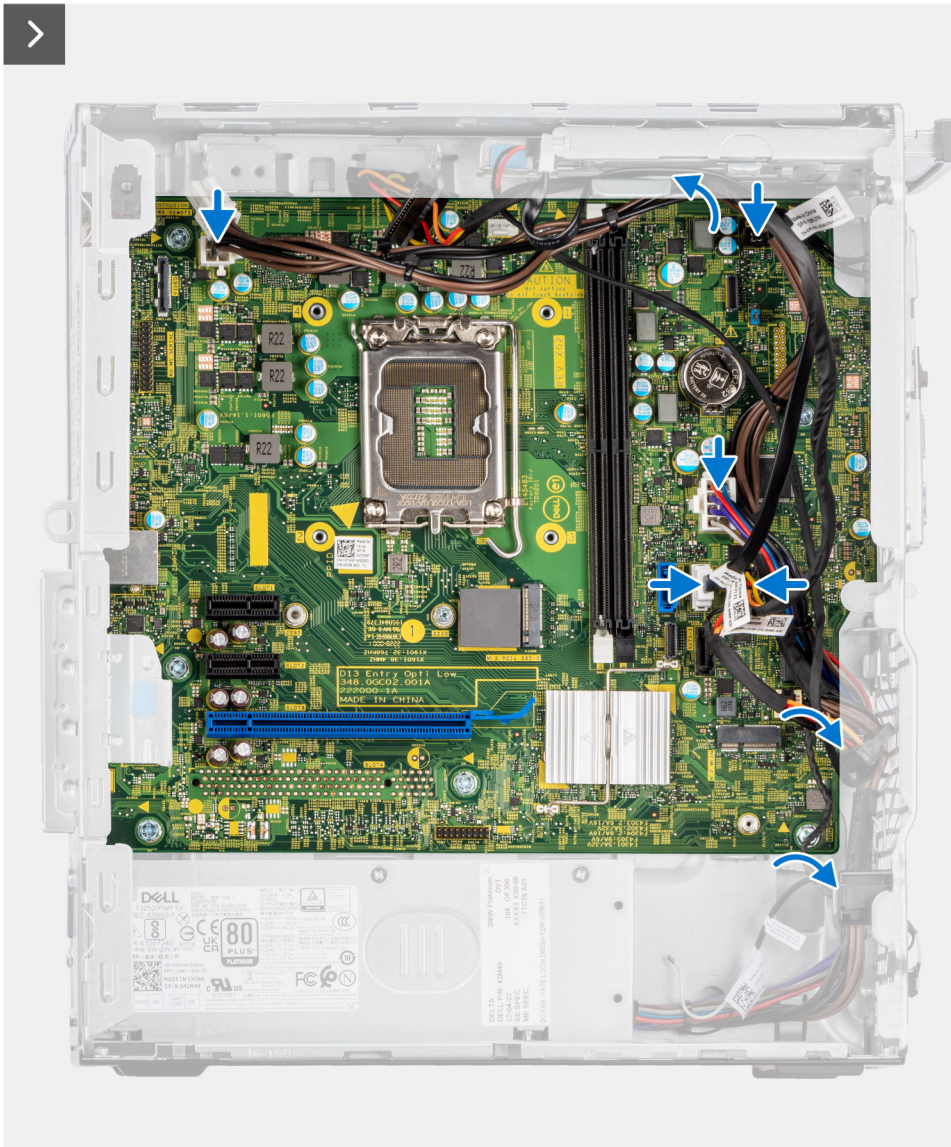

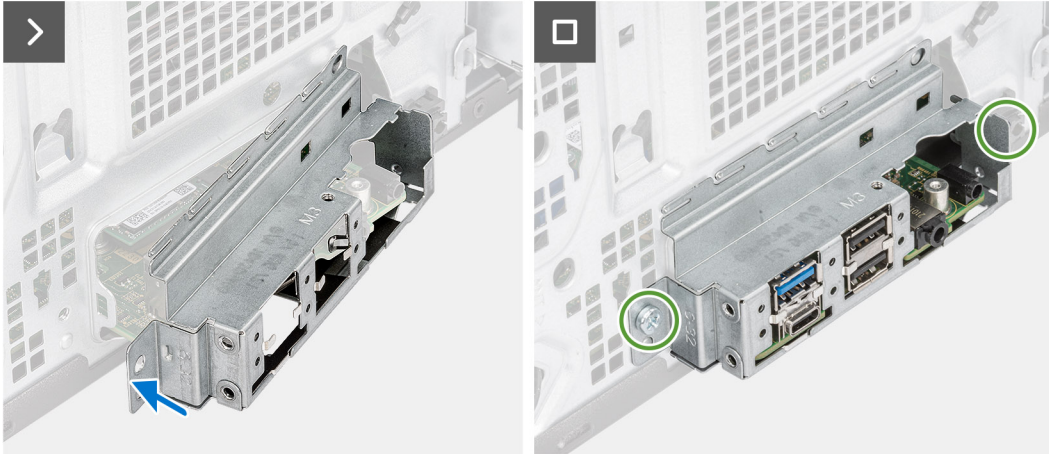

Steps

1. Slide the front I/O-ports on the system board into the front I/O-slots on the chassis and align the screw holes on the system board with the screw holes on the chassis.
2. Replace the (6-32) M.2 standoff screw to secure the system board to the chassis.
3. Replace the eight (6-32) screws that secure the system board to the chassis.
4. Route the cables through the routing guides on the chassis and connect the power and HDD cables to their respective connectors on the system board.
5. Lift the pull tab to close the PCIe door.
6. Align the front I/O-bracket with the slots on the chassis.
7. Replace the two (#6-32) screws that secure the front I/O-bracket to the chassis.

Next steps

1. Install the [processor](#).
2. Install the or [processor fan and heat-sink assembly](#).
3. Install the [3.5-inch hard drive](#).
4. Install the [graphics card](#).
5. Install the [M.2 2230 SSD/M.2 2280 SSD](#).
6. Install the [WLAN](#).
7. Install the [memory module](#).
8. Install the [fan duct](#)
9. Install the [front bezel](#).
10. Install the [side cover](#).
11. Follow the procedure in [after working inside your computer](#).

NOTE: Your computer's Service Tag is stored in the system board. You must enter the Service Tag in the BIOS setup program after you replace the system board.

NOTE: Replacing the system board removes any changes that you have made to the BIOS using the BIOS setup program. You must make the appropriate changes again after you replace the system board.

Software

This chapter details the supported operating systems along with instructions on how to install the drivers.

Operating system

Your OptiPlex Tower 7010 supports the following operating systems:

- Windows 11 Home
- Windows 11 Pro
- Windows 11 Pro Downgrade (Windows 10 image)
- Windows 11 Pro National Education
- Windows 10 CMIT Government Edition, (China only)
- Ubuntu Linux 22.04 LTS

Drivers and downloads

When troubleshooting, downloading or installing drivers it is recommended that you read the Dell Knowledge Base article, Drivers and Downloads FAQ [000123347](#).

BIOS setup

CAUTION: Unless you are an expert computer user, do not change the settings in the BIOS Setup program. Certain changes can make your computer work incorrectly.

NOTE: Depending on the computer and its installed devices, the items listed in this section may or may not be displayed.

NOTE: Before you change BIOS Setup program, it is recommended that you write down the BIOS Setup program screen information for future reference.

Use the BIOS Setup program for the following purposes:

- Get information about the hardware installed in your computer, such as the amount of RAM and the size of the hard drive.
- Change the system configuration information.
- Set or change a user-selectable option, such as the user password, type of hard drive installed, and enabling or disabling base devices.

Entering BIOS setup program

About this task

Turn on (or restart) your computer and press F2 immediately.

Navigation keys

NOTE: For most of the System Setup options, changes that you make are recorded but do not take effect until you restart the system.

Table 26. Navigation keys

Keys	Navigation
Up arrow	Moves to the previous field.
Down arrow	Moves to the next field.
Enter	Selects a value in the selected field (if applicable) or follow the link in the field.
Spacebar	Expands or collapses a drop-down list, if applicable.
Tab	Moves to the next focus area. NOTE: For the standard graphics browser only.
Esc	Moves to the previous page until you view the main screen. Pressing Esc in the main screen displays a message that prompts you to save any unsaved changes and restarts the system.

One Time Boot menu

To enter **One Time Boot menu**, turn on your computer, and then press F12 immediately.

NOTE: It is recommended to shutdown the computer if it is on.

The one-time boot menu displays the devices that you can boot from including the diagnostic option. The boot menu options are:

- Removable Drive (if available)
- STXXXX Drive (if available)
-  **NOTE:** XXX denotes the SATA drive number.
- Optical Drive (if available)
- SATA Hard Drive (if available)
- Diagnostics

The boot sequence screen also displays the option to access the System Setup screen.

System setup options

 **NOTE:** Depending on your computer and its installed devices, the items that are listed in this section may or may not appear.

Table 27. System setup options—System information menu

Overview	
OptiPlex Tower 7010	
BIOS Version	Displays the BIOS version number.
Service Tag	Displays the Service Tag of the computer.
Asset Tag	Displays the Asset Tag of the computer.
Manufacture Date	Displays the manufacture date of the computer.
Ownership Date	Displays the ownership date of the computer.
Express Service Code	Displays the express service code of the computer.
Ownership Tag	Displays the Ownership Tag of the computer.
Signed Firmware Update	Displays whether the Signed Firmware Update is enabled on your computer.
Processor Information	
Processor Type	Displays the processor type.
Maximum Clock Speed	Displays the maximum processor clock speed.
Minimum Clock Speed	Displays the minimum processor clock speed.
Current Clock Speed	Displays the current processor clock speed.
Core Count	Displays the number of cores on the processor.
Processor ID	Displays the processor identification code.
Processor L2 Cache	Displays the processor L2 Cache size.
Processor L3 Cache	Displays the processor L3 Cache size.
Microcode Version	Displays the microcode version.
Intel Hyper-Threading Capable	Displays whether the processor is Hyper-Threading (HT) capable.
64-Bit Technology	Displays whether 64-bit technology is used.
Memory Information	
Memory Installed	Displays the total computer memory installed.
Memory Available	Displays the total computer memory available.
Memory Speed	Displays the memory speed.
Memory Channel Mode	Displays single or dual channel mode.
Memory Technology	Displays the technology that is used for the memory.

Table 27. System setup options—System information menu (continued)

Overview	
DIMM 1 Size	Displays the DIMM 1 memory size.
DIMM 2 Size	Displays the DIMM 2 memory size.
DIMM 3 Size	Displays the DIMM 3 memory size.
DIMM 4 Size	Displays the DIMM 4 memory size.
Devices Information	
Video Controller	Displays the video controller type of the computer.
Video Memory	Displays the video memory information of the computer.
Wi-Fi Device	Displays the wireless device information of the computer.
Native Resolution	Displays the native resolution of the computer.
Video BIOS Version	Displays the video BIOS version of the computer.
Audio Controller	Displays the audio controller information of the computer.
Bluetooth Device	Displays the Bluetooth device information of the computer.
LOM MAC Address	Displays the LAN On Motherboard (LOM) MAC address of the computer.
dGPU Video Controller	Displays the discrete video controller type of the computer.
Slot 1	Displays the PCIe information of the computer.
Slot 2	Displays the PCIe information of the computer.
Slot 3	Displays the PCIe information of the computer.
Slot 4	Displays the PCIe information of the computer.

Table 28. System setup options—Boot Configuration menu

Boot Configuration	
Boot Sequence	
Boot Mode: UEFI only	Displays the boot mode of the computer.
Boot Sequence	Displays the boot sequence.
Secure Digital (SD) Card Boot	
	Enable or disable the SD card read-only boot. By default, the Secure Digital (SD) Card Boot option is enabled.
Secure Boot	
	Secure Boot is a method of guaranteeing the integrity of the boot path by performing additional validation of the operating system and PCI add-in cards. The computer stops booting to the operating system when a component is not authenticated during the boot process.
Enable Secure Boot	Enables the computer to boot using only validated boot software. By default, the Enable Secure Boot option is enabled. For additional security, Dell Technologies recommends keeping the Secure Boot option enabled to ensure that the UEFI firmware validates the operating system during the boot process. NOTE: For Secure Boot to be enabled, the computer is required to be in UEFI boot mode and the Enable Legacy Option ROMs option is required to be turned off.
Secure Boot Mode	Enables or disables the Secure Boot operation mode. By default, the Deployed Mode is selected. NOTE: Deployed Mode should be selected for normal operation of Secure Boot.

Table 28. System setup options—Boot Configuration menu (continued)

Boot Configuration	
Enable Microsoft UEFI CA	<p>When disabled, the UEFI CA is removed from the BIOS UEFI Secure Boot database.</p> <p>i NOTE: When disabled, the Microsoft UEFI CA could render your computer unable to boot, system graphics may not function, some devices may not function properly, and the computer could become unrecoverable.</p> <p>By default, the Enable Microsoft UEFI CA option is enabled.</p> <p>For additional security, Dell Technologies recommends keeping the Microsoft UEFI CA option enabled to ensure the broadest compatibility with devices and operating systems.</p>
Expert Key Management	
Enable Custom Mode	<p>Enables or disables the keys in the PK, KEK, db, and dbx security key databases to be modified.</p> <p>By default, the Enable Custom Mode option is disabled.</p>
Custom Mode Key Management	<p>Selects the custom values for expert key management.</p> <p>By default, the PK option is selected.</p>

Table 29. System setup options—Integrated Devices menu

Integrated Devices	
Date/Time	Displays the current date in MM/DD/YYYY format and current time in HH:MM:SS AM/PM format.
Audio	
Enable Audio	<p>Enable or disable the integrated audio controller.</p> <p>By default, all the options are enabled.</p>
Serial Port	
Serial Port Configuration	<p>Enable or disable the serial port address.</p> <p>By default, the COM1: Port is configured at 3F8h with IRQ4 option is enabled.</p>
USB Configuration	<ul style="list-style-type: none"> Enable or disable booting from USB mass storage devices through the boot sequence or boot menu. <p>By default, all the options are enabled.</p>
Front USB Configuration	<p>Enable or disable the individual front USB ports.</p> <p>By default, all the options are enabled.</p>
Rear USB Configuration	<p>Enable or disable the individual rear USB ports.</p> <p>By default, all the options are enabled.</p>
Dust Filter Maintenance	<p>Enable or disable the dust filter maintenance.</p> <p>By default, the Disabled option is enabled.</p>

Table 30. System setup options—Storage menu

Storage	
SATA Operation	<p>Enable or disable the operating mode of the integrated SATA hard drive controller.</p> <p>By default, the RAID On option is enabled.</p>
Storage Interface	

Table 30. System setup options—Storage menu (continued)

Storage	
Port Enablement	Enable or disable the onboard drives. By default, all the options are enabled.
SMART Reporting	
Enable SMART Reporting	Enable or disable Self-Monitoring, Analysis, and Reporting Technology (SMART) during computer startup. By default, the Enable SMART Reporting option is not enabled.
Drive Information	
SATA-0	
Type	Displays the SATA HDD type information of the computer.
Device	Displays the SATA HDD device information of the computer.
SATA-1	
Type	Displays the SATA HDD type information of the computer.
Device	Displays the SATA HDD device information of the computer.
SATA-2	
Type	Displays the SATA HDD type information of the computer.
Device	Displays the SATA HDD device information of the computer.
SATA-3	
Type	Displays the SATA HDD type information of the computer.
Device	Displays the SATA HDD device information of the computer.
M.2 PCIe SSD-0	
Type	Displays the M.2 PCIe SSD-0 type information of the computer.
Device	Displays the M.2 PCIe SSD-0 device information of the computer.
Enable MediaCard	
Secure Digital (SD) Card	Enable or disable the SD card. By default, the Secure Digital (SD) Card option is enabled.
Secure Digital (SD) Card Read-Only Mode	Enable or disable the SD card read-only mode. By default, the Secure Digital (SD) Card Read-Only Mode option is not enabled.

Table 31. System setup options—Display menu

Display	
Multi-Display	
Enable Multi-Display	Enable or disable the Enable Multi-Display buttons on the computer. By default, the option is enabled.
Primary Display	
Video Primary Display	Determines the primary display when multiple controllers are available on the computer By default, the Auto option is enabled.
Full Screen Logo	
	Enable or disable full screen logo. By default, the option is not enabled.

Table 32. System setup options—Connection menu

Connection	
Network Controller Configuration	
Integrated NIC	Controls the on-board LAN controller. By default, the Enabled with PXE option is enabled.
Wireless Device Enable	
WLAN	Enable or disable the internal WLAN device By default, the option enabled.
Bluetooth	Enable or disable the internal Bluetooth device By default, the option enabled.
Enable UEFI Network Stack	Enable or disable UEFI Network Stack and controls the on-board LAN Controller. By default, the option is enabled.
HTTPs Boot Feature	
HTTPs Boot	Enable or disable the HTTPs Boot feature. By default, the HTTPs Boot option is enabled.
HTTPs Boot Mode	With Auto Mode, the HTTPs Boot extracts Boot URL from the DHCP. With Manual Mode, the HTTPs Boot reads Boot URL from the user-provided data. By default, the Auto Mode option is enabled.

Table 33. System setup options—Power menu

Power	
USB PowerShare	
Enable USB PowerShare	Enable or disable the USB PowerShare. By default, the Enable USB PowerShare option is enabled
USB Wake Support	
Enable USB Wake Support	When enabled, you can use the USB devices like a mouse or keyboard to wake your computer from standby. By default, the option is enabled.
AC Behavior	
AC Recovery	Enables the system to turn on automatically, when AC is inserted. By default, the Power Off option is enabled.
Active State Power Management	
Aspm	Enables or disables the Active State Power Management (ASPM) level By default, the Auto option is enabled.
Block Sleep	
	Enables to block entering sleep (S3) mode in the operating system. By default, the Block Sleep option is disabled.
Deep Sleep Control	
	Enable or disable the Deep Sleep mode support. By default, the Disabled option is enabled.
Fan Control Override	
	Enable or disable the fan control override feature. By default, the option is disabled.
Intel Speed Shift Technology	
	Enable or disable the Intel speed shift technology support.

Table 33. System setup options—Power menu (continued)

Power	
By default, the Intel Speed Shift Technology option is enabled.	

Table 34. System setup options—Security menu

Security	
TPM 2.0 Security	
TPM 2.0 Security On	<p>Trusted Platform Module (TPM) is a security device that stores computer-generated keys for encryption and features such as BitLocker, Virtual Secure Mode, remote Attestation.</p> <p>By default, the Trusted Platform Module (TPM) option is enabled.</p> <p>For additional security, Dell Technologies recommends keeping Trusted Platform Module (TPM) enabled to allow these security technologies to fully function.</p>
TPM On	<p>Allows you to enable or disable TPM.</p> <p>By default, the TPM On option is enabled.</p> <p>For additional security, Dell Technologies recommends keeping TPM enabled to allow these security technologies to fully function.</p>
Physical Presence Interface (PPI) Bypass for Enable Commands	<p>The Physical Presence Interface (PPI) Bypass options can be used to allow the operating system to manage certain aspects of the TPM. If these options are enabled, you are not prompted to confirm certain changes to the TPM configuration.</p> <p>By default, the PPI Bypass for Enable Commands option is enabled.</p> <p>For additional security, Dell Technologies recommends keeping the PPI Bypass for Enable Commands option enabled.</p>
Physical Presence Interface (PPI) Bypass for Disable Commands	<p>By default, the PPI Bypass for Disable Commands option is disabled.</p> <p>For additional security, Dell Technologies recommends keeping the PPI Bypass for Disable Commands option disabled.</p>
Physical Presence Interface (PPI) Bypass for Clear Commands	<p>By default, the PPI Bypass for Clear Commands option is disabled.</p> <p>For additional security, Dell Technologies recommends keeping the PPI Bypass for Clear Commands option disabled.</p>
Attestation Enable	<p>The Attestation Enable option controls the endorsement hierarchy of TPM. Disabling the Attestation Enable option prevents TPM from being used to digitally-sign certificates.</p> <p>By default, the Attestation Enable option is enabled.</p> <p>For additional security, Dell Technologies recommends keeping the Attestation Enable option enabled.</p> <p>i NOTE: When disabled, this feature may cause compatibility issues or loss of functionality in some operating systems.</p>
Key Storage Enable	<p>The Key Storage Enable option controls the storage hierarchy of TPM, which is used to store digital keys. Disabling the Key Storage Enable option restricts the ability of TPM to store owner's data.</p> <p>By default, the Key Storage Enable option is enabled.</p> <p>For additional security, Dell Technologies recommends keeping the Key Storage Enable option enabled.</p> <p>i NOTE: When disabled, this feature may cause compatibility issues or loss of functionality in some operating systems.</p>

Table 34. System setup options—Security menu (continued)

Security	
SHA-256	<p>Allows you control the usage of SHA-256 by TPM. When enabled, the BIOS and TPM use the SHA-256 hash algorithm to extend measurements into the TPM PCRs during BIOS boot. When disabled, the BIOS and TPM use the SHA-1 hash algorithm to extend measurements into the TPM PCRs during BIOS boot.</p> <p>By default, the SHA-256 option is enabled.</p> <p>For additional security, Dell Technologies recommends keeping the SHA-256 option enabled.</p>
Clear	<p>When enabled, the Clear option clears information stored in the TPM after exiting the system's BIOS. This option returns to disabled state when the system restarts.</p> <p>By default, the Clear option is disabled.</p> <p>Dell Technologies recommends enabling the Clear option only when TPM data is required to be cleared.</p>
PPI ByPass for Clear Commands	<p>Controls the TPM Physical Presence Interface (PPI).</p> <p>By default, the PPI ByPass for clear Commands option is disabled.</p>
TPM State	<p>Enables or disables the Trusted Platform Module (TPM). This is the normal operating state for the Trusted Platform Module (TPM) when you want to use its complete array of capabilities.</p> <p>By default, the TPM State option is enabled.</p>
Intel Platform Trust Technology (PTT)	
PTT On	<p>Intel PTT is a firmware-based Trusted Platform Module (fTPM) device that is part of Intel chipsets. It provides credential storage and key management that can replace the equivalent functionality of a discrete TPM chip.</p> <p>Enables or disables the Intel PTT option.</p> <p>By default, the PTT On option is enabled.</p> <p>For additional security, Dell Technologies recommends keeping the PTT On option enabled.</p>
Physical Presence Interface (PPI) Bypass for Clear Commands	<p>The PPI Bypass for Clear Commands option allows the operating system to manage certain aspects of PTT. When enabled, you are not prompted to confirm changes to the PTT configuration.</p> <p>By default, the PPI Bypass for Clear Commands option is disabled.</p> <p>For additional security, Dell Technologies recommends keeping the PPI Bypass for Clear Commands option disabled.</p>
Clear	<p>When enabled, the Clear option clears the information stored in the PTT fTPM after exiting the system's BIOS. This option returns to disabled state when the system restarts.</p> <p>By default, the Clear option is disabled.</p> <p>Dell Technologies recommends enabling the Clear option only when PTT fTPM data needs to be cleared.</p>
Chassis intrusion	
Chassis Intrusion Detection	<p>Allows you to control the chassis intrusion feature. This feature notifies the user when the base cover has been removed from the computer.</p> <p>When set to Enabled, a notification is displayed on the next boot and the event is logged in the BIOS Events log.</p> <p>When set to On-Silent, the event is logged in the BIOS Events log, but no notification is displayed.</p>

Table 34. System setup options—Security menu (continued)

Security	
	<p>When set to Disabled, no notification is displayed and no event is logged in the BIOS Events log.</p> <p>By default, the Chassis Intrusion Detection option is enabled.</p> <p>For additional security, Dell Technologies recommends keeping the Chassis Intrusion Detection option enabled.</p>
Block Boot Until Cleared	<p>Enables or disables the Block Boot Until Cleared option.</p> <p>By default, the Block Boot Until Cleared option is enabled.</p> <p>i NOTE: When enabled, the computer does not boot until the chassis intrusion is cleared. If the administrator password is set, Setup has to be unlocked before the warning can be cleared.</p>
Legacy Manageability Interface Access	<p>Allows the administrator to control the access to BIOS configuration through the Legacy Manageability Interface option. When enabled, this prevents the BIOS Administrator password-based manageability tools from running, prevents some Dell software applications from reading configuration settings, and/or prevents changes to the BIOS configuration settings.</p> <p>When enabled, this option only supports the Authenticated BIOS Manageability Interface (ABI) for managing the BIOS configuration changes. To support this feature, ABI must be enabled and provisioned.</p> <p>When set to Enabled, the Legacy Manageability Interface can be used to read and change BIOS configuration settings.</p> <p>When set to Read-Only, BIOS configuration settings can be read, but cannot be changed through the Legacy Manageability Interface.</p> <p>When set to Disabled, the Legacy Manageability Interface is disabled. BIOS configuration reads and writes are blocked.</p>
SMM Security Mitigation	<p>Enables or disables additional UEFI SMM Security Mitigation protections. This option uses the Windows SMM Security Mitigations Table (WSMT) to confirm to the operating system that security best practices have been implemented by the UEFI firmware.</p> <p>By default, the SMM Security Mitigation option is enabled.</p> <p>For additional security, Dell Technologies recommends keeping the SMM Security Mitigation option enabled unless you have a specific application which is not compatible.</p> <p>i NOTE: This feature may cause compatibility issues or loss of functionality with some legacy tools and applications.</p>
Data Wipe on Next Boot	
Start Data Wipe	<p>⚠ CAUTION: Secure Data Wipe operation deletes information in a way that it cannot be reconstructed.</p> <p>Commands such as delete and format in the operating system may remove files from showing up in the file system, however they can be reconstructed through forensic means as they are still represented on the physical media. Data Wipe prevents this reconstruction and is not recoverable.</p> <p>When enabled, the BIOS will queue up a data wipe cycle for storage devices that are connected to the motherboard on the next reboot.</p> <p>By default, the Start Data Wipe option is disabled.</p>
Absolute	<p>Enables, disables, or permanently disables the BIOS module interface of the optional Absolute Persistence Module service from Absolute software.</p> <p>By default, the Absolute option is enabled.</p>

Table 34. System setup options—Security menu (continued)

Security	
	<p>For additional security, Dell Technologies recommends keeping the Absolute option enabled.</p> <p>⚠ WARNING: The 'Permanently Disabled' option can only be selected once. When 'Permanently Disabled' is selected, Absolute Persistence cannot be re-enabled. No further changes to the Enable/Disable states are allowed.</p> <p>i NOTE: The Enable/Disable options are unavailable while the computer is in the activated state.</p> <p>i NOTE: When the Absolute features are activated, the Absolute integration cannot be disabled from the BIOS setup screen.</p>
UEFI Boot Path Security	<p>Enables or disables the computer to prompt the user to enter the Administrator password (if set) when booting to a UEFI boot path device from the F12 boot menu.</p> <p>By default, the Always Except Internal HDD option is enabled.</p>
Firmware Device Tamper Detection	<p>Allows you to control the firmware device tamper detection feature. This feature notifies the user when the firmware device is tampered. When enabled, a screen warning messages are displayed on the computer and a tamper detection event is logged in the BIOS Events log. The computer fails to reboot until the event is cleared.</p> <p>By default, the Firmware Device Tamper Detection option is enabled.</p> <p>For additional security, Dell Technologies recommends keeping the Firmware Device Tamper Detection option enabled.</p>

Table 35. System setup options—Passwords menu

Passwords	
Administrator Password	<p>The Administrator Password prevents unauthorized access to the BIOS Setup options. Once the administrator password is set, the BIOS setup options can only be modified after providing the correct password.</p> <p>The following rules and dependencies apply to the Administrator Password -</p> <ul style="list-style-type: none"> • The administrator password cannot be set if system and/or internal hard drive passwords are previously set. • The administrator password can be used in place of the system and/or internal hard drive passwords. • When set, the administrator password must be provided during a firmware update. • Clearing the administrator password also clears the system password (if set). <p>Dell Technologies recommends using an administrator password to prevent unauthorized changes to BIOS setup options.</p>
System Password	<p>The System Password prevents the system from booting to an operating system without entering the correct password.</p> <p>The following rules and dependencies apply when the System Password is used -</p> <ul style="list-style-type: none"> • The computer shuts down when idle for approximately 10 minutes at the system password prompt. • The computer shuts down after three incorrect attempts to enter the system password. • The computer shuts down when the Esc key is pressed at the System Password prompt.

Table 35. System setup options—Passwords menu (continued)

Passwords	
	<ul style="list-style-type: none"> The system password is not prompted when the computer resumes from standby mode. <p>Dell Technologies recommends using the system password in situations where it is likely that a system may be lost or stolen.</p>
Hard Drive Password	<p>The Hard Drive Password can be set to prevent unauthorized access of the data stored on the hard drive. The computer prompts for the hard drive password during boot in order to unlock the drive. A password secured hard drive stays locked even when removed from the computer or placed into another computer. It prevents an attacker from accessing data on the drive without authorization.</p> <p>The following rules and dependencies apply when the Hard Drive Password is used -</p> <ul style="list-style-type: none"> The hard drive password option cannot be accessed when a hard drive is disabled in the BIOS setup. The computer shuts down when idle for approximately 10 minutes at the hard drive password prompt. The computer shuts down after three incorrect attempts to enter the hard drive password and treats the hard drive as not available. The hard drive does not accept password unlock attempts after five incorrect attempts to enter the hard drive password from the BIOS Setup. The hard drive password must be reset for the new password unlock attempts. The computer treats the hard drive as not available when the Esc key is pressed at the hard drive password prompt. The hard drive password is not prompted when the computer resumes from standby mode. When the hard drive is unlocked by the user before the computer goes into standby mode, it remains unlocked after the computer resumes from standby mode. If the system and hard drive passwords are set to the same value, the hard drive unlocks after the correct system password is entered. <p>Dell Technologies recommends using a hard drive password to protect unauthorized data access.</p>
Owner Password	<p>The Owner Password is typically used when a system is loaned or leased, and the end user sets their own system or hard drive password. The Owner Password can provide override access to unlock the system when it is returned. The Owner Password cannot be set via BIOS Setup. System lessors are given a tool which enables them to configure the Owner Password.</p> <p>The following rules and dependencies apply when the Owner Password is used -</p> <ul style="list-style-type: none"> The owner password cannot be set when the administrator password is already set. The owner password can be used in place of the administrator, system, or hard drive passwords. <p> NOTE: The hard drive password must have been set on the computer with owner password.</p> <p>Dell Technologies recommends that only system lessors use the owner password.</p>
Strong Password	<p>The Strong Password feature enforces stricter rules for administrator, owner, and system passwords.</p> <p>When enabled, the following rules are enforced -</p> <ul style="list-style-type: none"> The minimum length of the password is set to 8 characters. The password is required to include at least 1 upper case and 1 lower case character.

Table 35. System setup options—Passwords menu (continued)

Passwords	
	<p>NOTE: These requirements do not affect the hard drive password.</p> <p>By default, the Strong Password option is enabled.</p> <p>For additional security, Dell Technologies recommends keeping the Strong Password option enabled as it requires passwords be more complex.</p>
<p>NVMe SSD0</p> <p>Password Configuration</p>	<p>Set, change, or delete the NVMe SSD0 password.</p> <p>The Password configuration page includes several options for changing the requirements of BIOS passwords. You can modify the minimum and maximum length of the passwords as well as require passwords to contain certain character classes (upper case, lower case, digit, special character).</p> <p>Dell Technologies recommends setting the minimum password length to at least 8 characters.</p>
<p>Password Bypass</p>	<p>The Password Bypass option allows the computer to reboot from the operating system without entering the system or hard drive password. If the computer has already booted to the operating system, it is presumed that the user has already entered the correct system or hard drive password.</p> <p>NOTE: This option does not remove the requirement to enter the password after shutting down.</p> <p>By default, the Password Bypass option is enabled.</p> <p>For additional security, Dell Technologies recommends keeping the Password Bypass option enabled.</p>
<p>Password Changes</p> <p>Allow Non-Admin Password Changes</p>	<p>The Allow Non-Admin Password Changes option in BIOS setup allows an end user to set or change the system or hard drive passwords without entering the administrator password. This gives an administrator control over the BIOS settings but enables an end user to provide their own password.</p> <p>By default, the Allow Non-Admin Password Changes option is disabled.</p> <p>For additional security, Dell Technologies recommends keeping the Allow Non-Admin Password Changes option disabled.</p>
<p>Non-Admin Setup Changes</p>	<p>The Non-Admin Setup Changes option allows an end user to configure the wireless devices without requiring the administrator password.</p> <p>By default, the Non-Admin Setup Changes option is disabled.</p> <p>For additional security, Dell Technologies recommends keeping the Non-Admin Setup Changes option disabled.</p>
<p>Admin Setup Lockout</p>	<p>The Admin Setup Lockout option prevents an end user from even viewing the BIOS setup configuration without first entering the administrator password (if set).</p> <p>By default, the Admin Setup Lockout option is disabled.</p> <p>For additional security, Dell Technologies recommends keeping the Admin Setup Lockout option disabled.</p>
<p>Master Password Lockout</p>	
<p>Enable Master Password Lockout</p>	<p>The Master Password Lockout setting allows you to disable the Recovery Password feature. If the system, administrator, or hard drive password is forgotten, the system becomes unusable.</p> <p>NOTE: When the owner password is set, the Master Password Lockout option is not available.</p>

Table 35. System setup options—Passwords menu (continued)

Passwords	
	<p>NOTE: When an internal hard drive password is set, it must first be cleared before Master Password Lockout can be changed.</p> <p>By default, the Enable Master Password Lockout option is disabled.</p> <p>Dell Technologies does not recommend enabling the Master Password Lockout unless you have implemented your own password recovery system.</p>
Allow Non-Admin PSID Revert	
Enable Allow Non-Admin PSID Revert	<p>Controls access to the Physical Security ID (PSID) revert of NVMe hard-drives from the Dell Security Manager prompt.</p> <p>By default, the option is disabled.</p>

Table 36. System setup options—Update, Recovery menu

Update, Recovery	
UEFI Capsule Firmware Updates	<p>Enable or disable BIOS updates through UEFI capsule update packages.</p> <p>By default, the option is enabled.</p>
BIOS Recovery from Hard Drive	<p>Enables the user to recover from certain corrupted BIOS conditions from a recovery file on the user primary hard drive or an external USB key.</p> <p>By default, the option is enabled.</p>
BIOS Downgrade	
Allow BIOS Downgrade	<p>Enable or disable the flashing of the computer firmware to previous revision is blocked.</p> <p>By default, the option is enabled.</p>
SupportAssist OS Recovery	<p>Enable or disable the boot flow for SupportAssist OS Recovery tool in the event of certain computer errors.</p> <p>By default, the option is enabled.</p>
BIOSConnect	<p>Enable or disable cloud Service OS recovery if the main operating system fails to boot with the number of failures equal to or greater than the value specified by the Auto OS Recovery Threshold setup option and local Service OS does not boot or is not installed.</p> <p>By default, the option is enabled.</p>
Dell Auto OS Recovery Threshold	<p>Controls the automatic boot flow for SupportAssist System Resolution Console and for Dell OS Recovery Tool.</p> <p>By default, the threshold value is set to 2.</p>

Table 37. System setup options—System Management menu

System Management	
Service Tag	Display the Service Tag of the computer.
Asset Tag	Create a computer Asset Tag.
Wake on LAN/WLAN	<p>Enable or disable the computer to power on by special LAN signals when it receives a wakeup signal from the WLAN.</p> <p>By default, the Disabled option is selected.</p>
Auto on Time	<p>Enable to set the computer to turn on automatically every day or on a preselected date and time. This option can be configured only if the Auto On Time is set to Everyday, Weekdays, or Selected Days.</p> <p>By default, the option is disabled.</p>

Table 37. System setup options—System Management menu (continued)

System Management	
Intel AMT Capability	
Enable Intel AMT Capability	Enable or disable the Intel AMT capability. By default, the Restrict MEBx Access option is enabled.
MEBx Hotkey	
	Enable or disable MEBx hotkey. By default, the option is disabled.
USB Provision	
Enable USB Provision	Enable or disable the Intel AMT provisioning using the local provisioning file through a USB storage device. By default, the option is disabled.
SERR Messages	
	Enable or disable SERR messages. By default, the option is enabled.

Table 38. System setup options—Keyboard menu

Keyboard	
Keyboard Errors	
Enable Keyboard Error Detection	Enable or disable the keyboard error detection. By default, the option is enabled.
Numlock LED	
Enable Numlock LED	Enable or disable Numlock LED. By default, the option is enabled.
Device Configuration Hotkey Access	
Device Configuration Hotkey Access	Enable or disable users to access device configuration by using hotkeys. By default, the option is enabled.

Table 39. System setup options—Pre-boot Behavior menu

Pre-boot Behavior	
Warning and Errors	Enable or disable the action to be done when a warning or error is encountered. By default, the Prompt on Warnings and Errors option is enabled.
Fastboot	Enable to set the speed of the boot process. By default, the Minimal option is enabled.
Extend BIOS POST Time	Set the BIOS POST time. By default, the 0 seconds option is enabled.

Table 40. System setup options—Virtualization menu

Virtualization	
Intel Virtualization Technology	
Enable Intel Virtualization Technology (VT)	Specify whether a Virtual Machine Monitor (VMM) can utilize the additional hardware capabilities that are provided by Intel Virtualization Technology. By default, the option is enabled.

Table 40. System setup options—Virtualization menu (continued)

Virtualization	
<p>VT for Direct I/O</p>	<p>Specify whether a Virtual Machine Monitor (VMM) can utilize the additional hardware capabilities that are provided by Intel Virtualization Technology for Direct I/O.</p> <p>By default, the option is enabled.</p>
<p>Intel Trusted Execution Technology (TXT)</p>	<p>Specify whether a measured Virtual Machine Monitor (MVMM) can utilize the additional hardware capabilities that are provided by Intel Trusted Execution Technology.</p> <p>By default, the option is disabled.</p>
<p>Enable Intel Trusted Execution Technology (TXT)</p>	<p>Specifies whether a measured Virtual Machine Monitor (MVMM) can utilize the additional hardware capabilities that are provided by Intel Trusted Execution Technology.</p> <p>By default, the option is disabled.</p>

Table 41. System setup options—Performance menu

Performance	
<p>Multi Core Support</p> <p>Active Cores</p>	<p>Enables to change the number of CPU cores available to the operating system.</p> <p>By default, the All Cores options are enabled.</p>
<p>Intel SpeedStep</p> <p>Enable Intel SpeedStep Technology</p>	<p>Enables the computer to dynamically adjust processor voltage and core frequency, decreasing average power consumption and heat production.</p> <p>By default, the option is enabled.</p>
<p>C-States Control</p> <p>Enable C-State Control</p>	<p>Enable or disable additional processor sleep states.</p> <p>By default, the option is enabled.</p>
<p>Intel Turbo Boost Technology</p> <p>Enable Intel Turbo Boost Technology</p>	<p>Enable or disable Intel TurboBoost mode of the processor.</p> <p>By default, the option is enabled.</p>
<p>Intel Hyper-Threading Technology</p> <p>Enable Intel Hyper-Threading Technology</p>	<p>Enable or disable Hyper-Threading in the processor.</p> <p>By default, the option is enabled.</p>

Table 42. System setup options—System Logs menu

System Logs	
<p>BIOS Event Log</p> <p>Clear BIOS Event Log</p>	<p>Display BIOS events.</p> <p>By default, the Keep option is enabled.</p>

Updating the BIOS

Updating the BIOS in Windows

About this task

CAUTION: If BitLocker is not suspended before updating the BIOS, the next time you reboot the system it will not recognize the BitLocker key. You will then be prompted to enter the recovery key to progress and the system will ask for this on each reboot. If the recovery key is not known this can result in data loss or an unnecessary operating system re-install. For more information on this subject, search in the Knowledge Base Resource at www.dell.com/support.

Steps

1. Go to www.dell.com/support.
2. Click **Product support**. In the **Search support** box, enter the Service Tag of your computer, and then click **Search**.
NOTE: If you do not have the Service Tag, use the SupportAssist feature to automatically identify your computer. You can also use the product ID or manually browse for your computer model.
3. Click **Drivers & Downloads**. Expand **Find drivers**.
4. Select the operating system installed on your computer.
5. In the **Category** drop-down list, select **BIOS**.
6. Select the latest version of BIOS, and click **Download** to download the BIOS file for your computer.
7. After the download is complete, browse the folder where you saved the BIOS update file.
8. Double-click the BIOS update file icon and follow the on-screen instructions.
For more information, search in the Knowledge Base Resource at www.dell.com/support.

Updating the BIOS in Linux and Ubuntu

To update the system BIOS on a computer that is installed with Linux or Ubuntu, see the knowledge base article [000131486](https://www.dell.com/support/000131486) at www.dell.com/support.

Updating the BIOS using the USB drive in Windows

About this task

CAUTION: If BitLocker is not suspended before updating the BIOS, the next time you reboot the system it will not recognize the BitLocker key. You will then be prompted to enter the recovery key to progress and the system will ask for this on each reboot. If the recovery key is not known this can result in data loss or an unnecessary operating system re-install. For more information on this subject, search in the Knowledge Base Resource at www.dell.com/support.

Steps

1. Follow the procedure from step 1 to step 6 in [Updating the BIOS in Windows](#) to download the latest BIOS setup program file.
2. Create a bootable USB drive. For more information, search in the Knowledge Base Resource at www.dell.com/support.
3. Copy the BIOS setup program file to the bootable USB drive.
4. Connect the bootable USB drive to the computer that needs the BIOS update.
5. Restart the computer and press **F12**.
6. Select the USB drive from the **One Time Boot Menu**.
7. Type the BIOS setup program filename and press **Enter**.
The **BIOS Update Utility** appears.
8. Follow the on-screen instructions to complete the BIOS update.

Updating the BIOS from the F12 One-Time boot menu

Update your computer BIOS using the BIOS update.exe file that is copied to a FAT32 USB drive and booting from the F12 One-Time boot menu.

About this task

CAUTION: If BitLocker is not suspended before updating the BIOS, the next time you reboot the system it will not recognize the BitLocker key. You will then be prompted to enter the recovery key to progress and the system will ask for this on each reboot. If the recovery key is not known this can result in data loss or an unnecessary operating system re-install. For more information on this subject, search in the Knowledge Base Resource at www.dell.com/support.

BIOS Update

You can run the BIOS update file from Windows using a bootable USB drive or you can also update the BIOS from the F12 One-Time boot menu on the computer.

Most of the Dell computers built after 2012 have this capability, and you can confirm by booting your computer to the F12 One-Time Boot Menu to see if BIOS FLASH UPDATE is listed as a boot option for your computer. If the option is listed, then the BIOS supports this BIOS update option.

NOTE: Only computers with BIOS Flash Update option in the F12 One-Time boot menu can use this function.

Updating from the One-Time boot menu

To update your BIOS from the F12 One-Time boot menu, you need the following:

- USB drive formatted to the FAT32 file system (key does not have to be bootable)
- BIOS executable file that you downloaded from the Dell Support website and copied to the root of the USB drive
- AC power adapter that is connected to the computer
- Functional computer battery to flash the BIOS

Perform the following steps to perform the BIOS update flash process from the F12 menu:

CAUTION: Do not turn off the computer during the BIOS update process. The computer may not boot if you turn off your computer.

Steps

1. From a turn off state, insert the USB drive where you copied the flash into a USB port of the computer.
2. Turn on the computer and press F12 to access the One-Time Boot Menu, select BIOS Update using the mouse or arrow keys then press Enter.
The flash BIOS menu is displayed.
3. Click **Flash from file**.
4. Select external USB device.
5. Select the file and double-click the flash target file, and then click **Submit**.
6. Click **Update BIOS**. The computer restarts to flash the BIOS.
7. The computer will restart after the BIOS update is completed.

Updating the BIOS

Updating the BIOS in Windows

Steps

1. Go to www.dell.com/support.
2. Click **Product support**. In the **Search support** box, enter the Service Tag of your computer, and then click **Search**.

NOTE: If you do not have the Service Tag, use the SupportAssist feature to automatically identify your computer. You can also use the product ID or manually browse for your computer model.

3. Click **Drivers & Downloads**. Expand **Find drivers**.
4. Select the operating system installed on your computer.
5. In the **Category** drop-down list, select **BIOS**.
6. Select the latest version of BIOS, and click **Download** to download the BIOS file for your computer.
7. After the download is complete, browse the folder where you saved the BIOS update file.
8. Double-click the BIOS update file icon and follow the on-screen instructions.

For more information about how to update the system BIOS, search in the Knowledge Base Resource at www.dell.com/support.

Updating the BIOS using the USB drive in Windows

Steps

1. Follow the procedure from step 1 to step 6 in [Updating the BIOS in Windows](#) to download the latest BIOS setup program file.
2. Create a bootable USB drive. For more information, search the Knowledge Base Resource at www.dell.com/support.
3. Copy the BIOS setup program file to the bootable USB drive.
4. Connect the bootable USB drive to the computer that needs the BIOS update.
5. Restart the computer and press **F12**.
6. Select the USB drive from the **One Time Boot Menu**.
7. Type the BIOS setup program filename and press **Enter**.
The **BIOS Update Utility** appears.
8. Follow the on-screen instructions to complete the BIOS update.

Updating the BIOS in Linux and Ubuntu

To update the system BIOS on a computer that is installed with Linux or Ubuntu, see the knowledge base article [000131486](#) at www.dell.com/support.

Updating the BIOS from the F12 One Time Boot menu

Update your computer BIOS using the BIOS update.exe file that is copied to a FAT32 USB drive and booting from the F12 **One Time Boot** menu.

About this task

BIOS Update

You can run the BIOS update file from Windows using a bootable USB drive or you can also update the BIOS from the F12 **One Time Boot** menu on the computer.

Most of the Dell computers built after 2012 have this capability, and you can confirm by booting your computer to the F12 **One Time Boot** Menu to see if BIOS FLASH UPDATE is listed as a boot option for your computer. If the option is listed, then the BIOS supports this BIOS update option.

 **NOTE:** Only computers with BIOS Flash Update option in the F12 **One Time Boot** menu can use this function.

Updating from the One Time Boot menu

To update your BIOS from the F12 **One Time Boot** menu, you need the following:

- USB drive formatted to the FAT32 file system (key does not have to be bootable)
- BIOS executable file that you downloaded from the Dell Support website and copied to the root of the USB drive
- AC power adapter that is connected to the computer
- Functional computer battery to flash the BIOS

Perform the following steps to perform the BIOS update flash process from the F12 menu:

 **CAUTION:** Do not turn off the computer during the BIOS update process. The computer may not boot if you turn off your computer.

Steps

1. From a turn off state, insert the USB drive where you copied the flash into a USB port of the computer.
2. Turn on the computer and press F12 to access the **One Time Boot** Menu, select BIOS Update using the mouse or arrow keys then press Enter.
The flash BIOS menu is displayed.
3. Click **Flash from file**.
4. Select external USB device.
5. Select the file and double-click the flash target file, and then click **Submit**.
6. Click **Update BIOS**. The computer restarts to flash the BIOS.
7. The computer will restart after the BIOS update is completed.

System and setup password

Table 43. System and setup password

Password type	Description
System password	Password that you must enter to log in to your system.
Setup password	Password that you must enter to access and make changes to the BIOS settings of your computer.

You can create a system password and a setup password to secure your computer.

 **CAUTION:** The password features provide a basic level of security for the data on your computer.

 **CAUTION:** Anyone can access the data that is stored on your computer if it is not locked and left unattended.

 **NOTE:** System and setup password feature is disabled.

Assigning a system setup password

Prerequisites

You can assign a new **System or Admin Password** only when the status is in **Not Set**.

About this task

To enter the system setup, press F12 immediately after a power-on or reboot.

Steps

1. In the **System BIOS** or **System Setup** screen, select **Security** and press Enter.
The **Security** screen is displayed.
2. Select **System/Admin Password** and create a password in the **Enter the new password** field.
Use the following guidelines to assign the system password:
 - A password can have up to 32 characters.
 - At least one special character: ! " # \$ % & ' () * + , - . / : ; < = > ? @ [\] ^ _ ` { | }
 - Numbers 0 through 9.
 - Upper case letters from A to Z.
 - Lower case letters from a to z.
3. Type the system password that you entered earlier in the **Confirm new password** field and click **OK**.
4. Press Esc and save the changes as prompted by the pop-up message.
5. Press Y to save the changes.
The computer restarts.

Deleting or changing an existing system setup password

Prerequisites

Ensure that the **Password Status** is Unlocked (in the System Setup) before attempting to delete or change the existing System and/or Setup password. You cannot delete or change an existing System or Setup password, if the **Password Status** is Locked.

About this task

To enter the System Setup, press F12 immediately after a power-on or reboot.

Steps

1. In the **System BIOS** or **System Setup** screen, select **System Security** and press Enter.
The **System Security** screen is displayed.
2. In the **System Security** screen, verify that **Password Status** is **Unlocked**.
3. Select **System Password**, update, or delete the existing system password, and press Enter or Tab.
4. Select **Setup Password**, update, or delete the existing setup password, and press Enter or Tab.
 **NOTE:** If you change the System and/or Setup password, reenter the new password when prompted. If you delete the System and/or Setup password, confirm the deletion when prompted.
5. Press Esc and a message prompts you to save the changes.
6. Press Y to save the changes and exit from System Setup.
The computer restarts.

Clearing CMOS settings

About this task

 **CAUTION:** Clearing CMOS settings will reset the BIOS settings on your computer.

Steps

1. Remove the [side cover](#).
2. Remove the [coin-cell battery](#).
3. Wait for one minute.
4. Replace the [coin-cell battery](#).
5. Replace the [side cover](#).

Clearing BIOS (System Setup) and System passwords

About this task

To clear the system or BIOS passwords, contact Dell technical support as described at www.dell.com/contactdell.

 **NOTE:** For information on how to reset Windows or application passwords, refer to the documentation accompanying Windows or your application.

Troubleshooting

Dell SupportAssist Pre-boot System Performance Check diagnostics

About this task

SupportAssist diagnostics (also known as system diagnostics) performs a complete check of your hardware. The Dell SupportAssist Pre-boot System Performance Check diagnostics is embedded with the BIOS and is launched by the BIOS internally. The embedded system diagnostics provides a set of options for particular devices or device groups allowing you to:

- Run tests automatically or in an interactive mode
- Repeat tests
- Display or save test results
- Run thorough tests to introduce additional test options to provide extra information about the failed device(s)
- View status messages that inform you if tests are completed successfully
- View error messages that inform you of problems encountered during testing

 **NOTE:** Some tests for specific devices require user interaction. Always ensure that you are present at the computer terminal when the diagnostic tests are performed.

For more information, see <https://www.dell.com/support/kbdoc/000180971>.

Running the SupportAssist Pre-Boot System Performance Check

Steps

1. Turn on your computer.
2. As the computer boots, press the F12 key as the Dell logo appears.
3. On the boot menu screen, select the **Diagnostics** option.
4. Click the arrow at the bottom left corner.
Diagnostics front page is displayed.
5. Click the arrow in the lower-right corner to go to the page listing.
The items detected are listed.
6. To run a diagnostic test on a specific device, press Esc and click **Yes** to stop the diagnostic test.
7. Select the device from the left pane and click **Run Tests**.
8. If there are any issues, error codes are displayed.
Note the error code and validation number and contact Dell.

Power-Supply Unit Built-in Self-Test

Built-in Self-Test (BIST) helps determine if the power-supply unit is working. To run self-test diagnostics on the power-supply unit of a desktop or all-in-one computer, search in the Knowledge Base Resource at www.dell.com/support.

System-diagnostic lights

Table 44. Diagnostic LED behavior

Blinking pattern		Problem description	Suggested resolution
Amber	White		
1	2	Unrecoverable SPI Flash Failure	<ul style="list-style-type: none"> Replace the system board.
2	1	CPU failure	<ul style="list-style-type: none"> Run the Dell Support Assist/Dell Diagnostics tool. If problem persists, replace the system board.
2	2	System board failure (included BIOS corruption or ROM error)	<ul style="list-style-type: none"> Flash latest BIOS version If problem persists, replace the system board.
2	3	No memory/RAM detected	<ul style="list-style-type: none"> Confirm that the memory module is installed properly. If problem persists, replace the memory module.
2	4	Memory/RAM failure	<ul style="list-style-type: none"> Reset the memory module. If problem persists, replace the memory module.
2	5	Invalid memory installed	<ul style="list-style-type: none"> Reset the memory module. If problem persists, replace the memory module.
2	6	System board / Chipset Error / Clock failure / Gate A20 failure / Super I/O failure / Keyboard controller failure	<ul style="list-style-type: none"> Flash latest BIOS version If problem persists, replace the system board.
3	1	CMOS battery failure	<ul style="list-style-type: none"> Reset the CMOS battery connection. If problem persists, replace the RTS battery.
3	2	PCI or Video card/chip failure	Replace the system board.
3	3	BIOS Recovery image not found	<ul style="list-style-type: none"> Flash latest BIOS version If problem persists, replace the system board.
3	4	BIOS Recovery image found but invalid	<ul style="list-style-type: none"> Flash latest BIOS version If problem persists, replace the system board.
3	5	Power rail failure	<ul style="list-style-type: none"> EC ran into power sequencing failure. If problem persists, replace the system board.
3	6	SBIOS Flash corruption	<ul style="list-style-type: none"> Flash corruption detected by SBIOS

Table 44. Diagnostic LED behavior (continued)

Blinking pattern		Problem description	Suggested resolution
Amber	White		
			<ul style="list-style-type: none"> If problem persists, replace the system board.
3	7	Intel ME (Management Engine) Error	<ul style="list-style-type: none"> Timeout waiting on ME to reply to HECI message If problem persists, replace the system board.
4	2	CPU Power Cable Connection Issue	<ul style="list-style-type: none"> Reset the processor power cable.

Recovering the operating system

When your computer is unable to boot to the operating system even after repeated attempts, it automatically starts Dell SupportAssist OS Recovery.

Dell SupportAssist OS Recovery is a standalone tool that is preinstalled in all Dell computers installed with Windows operating system. It consists of tools to diagnose and troubleshoot issues that may occur before your computer boots to the operating system. It enables you to diagnose hardware issues, repair your computer, back up your files, or restore your computer to its factory state.

You can also download it from the Dell Support website to troubleshoot and fix your computer when it fails to boot into their primary operating system due to software or hardware failures.

For more information about the Dell SupportAssist OS Recovery, see *Dell SupportAssist OS Recovery User's Guide* at www.dell.com/serviceabilitytools. Click **SupportAssist** and then, click **SupportAssist OS Recovery**.

Real Time Clock—RTC reset

The Real Time Clock (RTC) reset function allows you or the service technician to recover the recently launched model Dell Latitude and Precision systems from **No POST/No Boot/No Power** situations. You can initiate the RTC reset on the system from a power-off state only if it is connected to AC power. Press and hold the power button for 25 seconds. The system RTC reset occurs after you release the power button.

NOTE: If AC power is disconnected from the system during the process or the power button is held longer than 40 seconds, the RTC reset process gets aborted.

The RTC reset will reset the BIOS to Defaults, un-provision Intel vPro and reset the system date and time. The following items are unaffected by the RTC reset:

- Service Tag
- Asset Tag
- Ownership Tag
- Admin Password
- System Password
- HDD Password
- Key Databases
- System Logs

NOTE: The IT administrator's vPro account and password on the system will be un-provisioned. The system needs to go through the setup and configuration process again to reconnect it to the vPro server.

The below items may or may not reset based on your custom BIOS setting selections:

- Boot List
- Enable Legacy Option ROMs
- Secure Boot Enable
- Allow BIOS Downgrade

Backup media and recovery options

It is recommended to create a recovery drive to troubleshoot and fix problems that may occur with Windows. Dell proposes multiple options for recovering Windows operating system on your Dell PC. For more information, see [Dell Windows Backup Media and Recovery Options](#).

Wi-Fi power cycle

About this task

If your computer is unable to access the Internet due to Wi-Fi connectivity issues a Wi-Fi power cycle procedure may be performed. The following procedure provides the instructions on how to conduct a Wi-Fi power cycle:

 **NOTE:** Some ISPs (Internet Service Providers) provide a modem/router combo device.

Steps



1. Turn off your computer.
2. Turn off the modem.
3. Turn off the wireless router.
4. Wait for 30 seconds.
5. Turn on the wireless router.
6. Turn on the modem.
7. Turn on your computer.

Getting help and contacting Dell

Self-help resources

You can get information and help on Dell products and services using these self-help resources:

Table 45. Self-help resources

Self-help resources	Resource location
Information about Dell products and services	www.dell.com
My Dell app	
Tips	
Contact Support	In Windows search, type <code>Contact Support</code> , and press Enter.
Online help for operating system	www.dell.com/support/windows www.dell.com/support/linux
Access top solutions, diagnostics, drivers and downloads, and learn more about your computer through videos, manuals and documents.	Your Dell computer is uniquely identified by a Service Tag or Express Service Code. To view relevant support resources for your Dell computer, enter the Service Tag or Express Service Code at www.dell.com/support . For more information on how to find the Service Tag for your computer, see Locate the Service Tag on your computer .
Dell knowledge base articles for a variety of computer concerns	<ol style="list-style-type: none"> 1. Go to www.dell.com/support. 2. On the menu bar at the top of the Support page, select Support > Knowledge Base. 3. In the Search field on the Knowledge Base page, type the keyword, topic, or model number, and then click or tap the search icon to view the related articles.

Contacting Dell

To contact Dell for sales, technical support, or customer service issues, see www.dell.com/contactdell.

 **NOTE:** Availability varies by country/region and product, and some services may not be available in your country/region.

 **NOTE:** If you do not have an active Internet connection, you can find contact information about your purchase invoice, packing slip, bill, or Dell product catalog.