

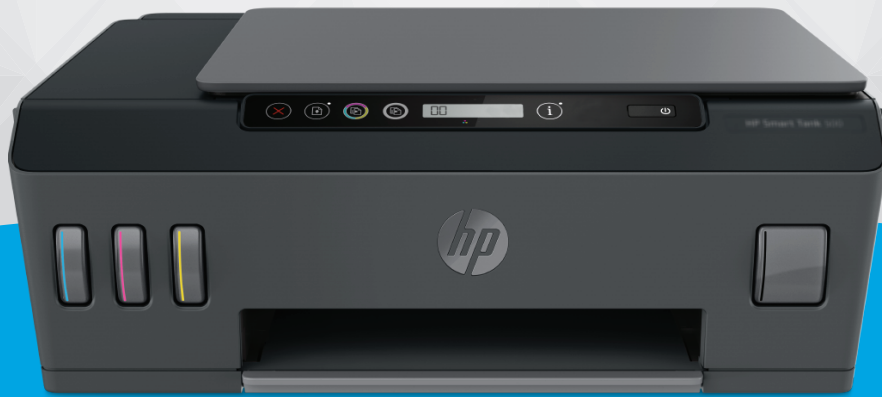

# User Guide



**HP Smart Tank 500 series**

**HP company notices**

THE INFORMATION CONTAINED HEREIN IS SUBJECT TO CHANGE WITHOUT NOTICE.

ALL RIGHTS RESERVED. REPRODUCTION, ADAPTATION, OR TRANSLATION OF THIS MATERIAL IS PROHIBITED WITHOUT PRIOR WRITTEN PERMISSION OF HP, EXCEPT AS ALLOWED UNDER THE COPYRIGHT LAWS. THE ONLY WARRANTIES FOR HP PRODUCTS AND SERVICES ARE SET FORTH IN THE EXPRESS WARRANTY STATEMENTS ACCOMPANYING SUCH PRODUCTS AND SERVICES. NOTHING HEREIN SHOULD BE CONSTRUED AS CONSTITUTING AN ADDITIONAL WARRANTY. HP SHALL NOT BE LIABLE FOR TECHNICAL OR EDITORIAL ERRORS OR OMISSIONS CONTAINED HEREIN.

© Copyright 2019 HP Development Company, L.P.

Microsoft and Windows are either registered trademarks or trademarks of Microsoft Corporation in the United States and/or other countries.

Mac, OS X, and macOS are trademarks of Apple Inc., registered in the U.S. and other countries.

ENERGY STAR and the ENERGY STAR mark are registered trademarks owned by the U.S. Environmental Protection Agency.

---

# Table of contents

<b>1 Get started</b> .....	<b>1</b>
Printer parts .....	2
Get to know the ink tank system .....	4
Control panel features .....	5
Control panel lights and display icons status .....	7
Change the paper settings .....	12
Paper basics .....	13
Open the HP printer software .....	15
Use the HP Smart app to print, scan, and troubleshoot .....	16
Sleep mode .....	17
Quiet Mode .....	18
Auto-Off .....	19
<b>2 Print</b> .....	<b>20</b>
Load media .....	21
Print documents .....	25
Print photos .....	27
Print envelopes .....	29
Print using the HP Smart app (Windows 10) .....	30
Print using the maximum dpi .....	31
Tips for print success .....	33
View print job status and manage print jobs (Windows) .....	36
Customize your printer (Windows) .....	37
<b>3 Copy and scan</b> .....	<b>38</b>
Copy documents .....	39
Load original .....	40
Scan using the HP Smart app (Windows 10) .....	41
Scan using the HP printer software .....	43
Tips for successful scanning and copying .....	46

<b>4 Manage ink and printhead .....</b>	<b>47</b>
Ink levels .....	48
Refill ink tanks .....	49
Order ink supplies .....	52
Print with black ink only .....	53
Improve print quality .....	54
Align printheads .....	56
Clean printheads .....	57
Clean printer .....	58
Tips for working with ink and printhead .....	59
Move printer .....	60
<b>5 Connect .....</b>	<b>61</b>
Connect your printer to your computer with a USB cable (non-network connection) .....	62
<b>6 Solve a problem .....</b>	<b>63</b>
Get help with HP online troubleshooting .....	64
Get more help .....	65
Printer control panel errors .....	66
Get help from the HP Smart app .....	67
Jams and paper-feed issues .....	68
Printhead (cartridge) problem .....	76
Printing issues .....	82
Copy issues .....	85
Scan issues .....	86
Printer hardware issues .....	87
Restore original factory defaults and settings .....	88
Maintain the printer .....	89
HP support .....	91
<b>Appendix A Technical information .....</b>	<b>93</b>
Specifications .....	94
Regulatory notices .....	96
Environmental product stewardship program .....	98
<b>Index .....</b>	<b>105</b>

---

# 1 Get started

- [Printer parts](#)
- [Get to know the ink tank system](#)
- [Control panel features](#)
- [Control panel lights and display icons status](#)
- [Change the paper settings](#)
- [Paper basics](#)
- [Open the HP printer software](#)
- [Use the HP Smart app to print, scan, and troubleshoot](#)
- [Sleep mode](#)
- [Quiet Mode](#)
- [Auto-Off](#)

## Printer parts

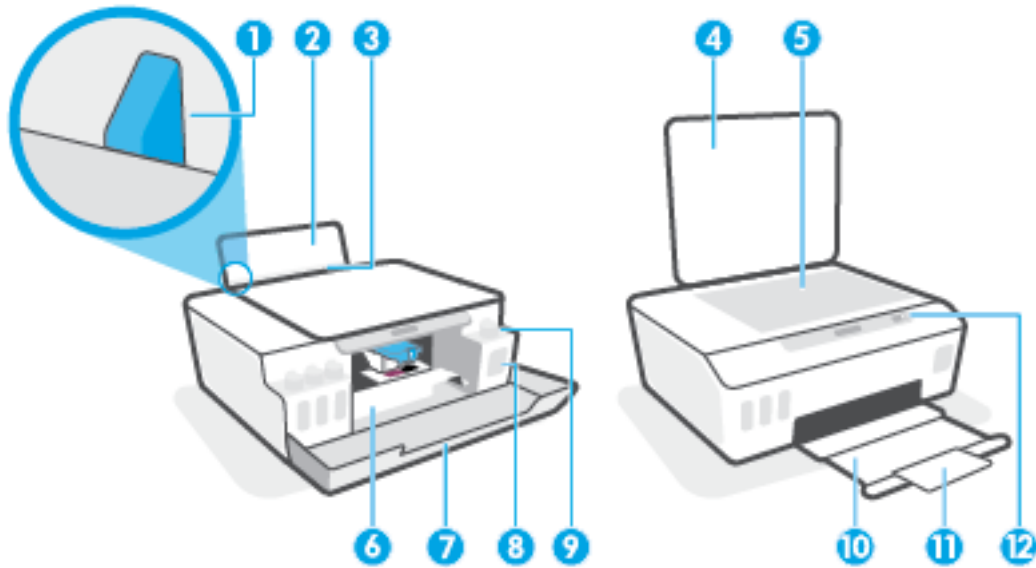

1	Paper-width guide
2	Input tray
3	Input tray shield
4	Scanner lid
5	Scanner glass
6	Printhead access door
7	Front door
8	Ink tank
9	Ink tank cap
10	Output tray
11	Output tray extender (also referred to as the tray extender)
12	Control panel

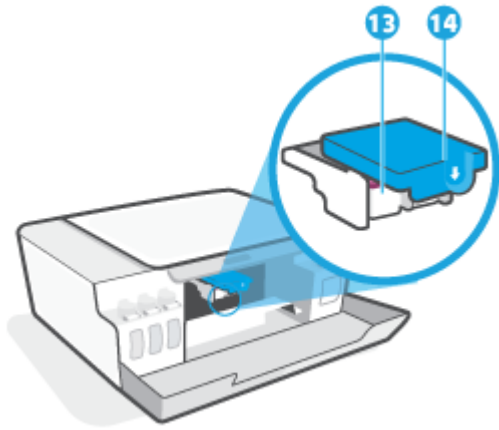

13	Printheads
14	Printhead latch

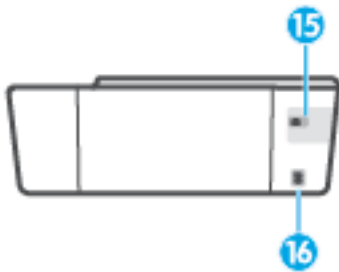

15	USB port
16	Power connection

## Get to know the ink tank system

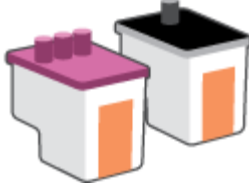
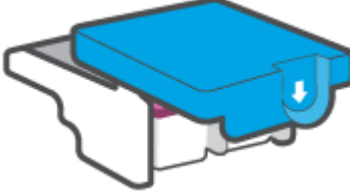
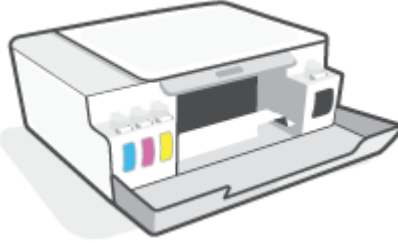
Term	Definition
Printheads	<p>The printheads are the components in the print mechanism that apply ink to the paper. There are two printheads: a black ink printhead and a color ink printhead.</p> <p><b>CAUTION:</b> After you have set up the printer, do not open the printhead latch unless instructed to do so.</p> 
Printhead latch	<p>The printhead latch on the carriage secures the printheads in the carriage. Make sure the printhead latch is properly closed to avoid problems such as carriage jams.</p> <p><b>CAUTION:</b> After you have set up the printer, do not open the printhead latch unless instructed to do so.</p> 
Ink tanks	<p>There are four ink tanks. Each ink tank corresponds to an individual color: cyan, magenta, yellow and, black.</p> 
Ink tank caps	<p>Ink tank caps are plugs that seal each ink tank.</p>
Alignment	<p>Alignment is a process of aligning the printheads to improve print quality.</p> <p>For more information about alignment, see <a href="#">Printhead Alignment icon on page 8</a>.</p>



# Control panel features

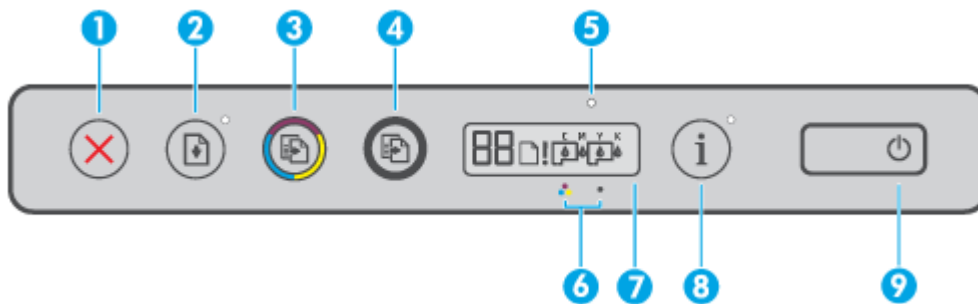

## Overview of buttons and lights



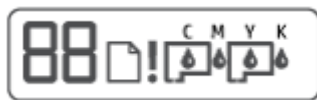

Feature	Description
1	<b>Cancel</b> button: Stops the current operation.
2	<b>Resume</b> button: Resumes a job after a disruption (for example, after loading paper or clearing a paper jam).  <b>Resume</b> light: Indicates the printer is in a warning or error state. Press  to continue printing after resolving the problem.
3	<b>Color Copy</b> button: Starts a color copy job. To increase the number counter, press and hold the button. Copying starts two seconds after the last button press.
4	<b>Black Copy</b> button: Starts a black-and-white copy job. To increase the number counter, press and hold the button. Copying starts two seconds after the last button press.
5	<b>Ink/Printhead light</b> : Indicates ink tank or printhead problems.
6	<b>Color Printhead</b> icon and <b>Black Printhead</b> icon.
7	<b>Control Panel Display</b> : Indicates number counter, paper status, as well as printheads and ink status or errors.
8	<b>Information</b> button: Press this button to print an information page of the printer.
9	<b>Power</b> button: Turns the printer on or off.

## Control panel display icons



Icon	Description
	Number Counter icon: Shows the number counter when you are copying documents, changes to the letter A when the printer is doing printhead alignment, and shows the letter E and a number when the printer is in an error state.
	Paper Error icon: Indicates a paper-related error.
	Alert icon: Indicates an error.

Icon	Description
<p data-bbox="252 216 367 241">C M Y K</p> 	<p data-bbox="539 216 1337 241">The CMYK icons and Ink icons are used to indicate status of the four ink tanks in the printer.</p> <p data-bbox="539 268 1228 294">Each set of icons corresponds to an ink tank: cyan, magenta, yellow and, black.</p>
	<p data-bbox="539 315 1428 367">Printhead icons: The left printhead icon flashing shows an error related to the tri-color printhead, and the right icon flashing shows an error related to the black printhead.</p>

# Control panel lights and display icons status

## Power button light



Status	Description
On	The printer is on.
Off	The printer is powered off.
Dimmed	Indicates the printer is in Sleep mode. <ul style="list-style-type: none"><li>• The printer automatically enters Sleep mode after 5 minutes of inactivity.</li><li>• The printer automatically turns off after 2 hours of inactivity, if it is not connected to other devices.</li></ul>
Blinking	The printer is processing a job. To cancel the job, press  (the Cancel button).
Fast blinking	If the printhead access door is open, close it. If the printhead access door is closed and the light is blinking fast, the printer is in an error state that you can resolve by following the on-screen messages from the computer. If you do not see any on-screen messages, try printing a document to generate an on-screen message.

## Printhead icons and Ink/Printhead light

- The Alert icon, one of the Printhead icons, and the Ink/Printhead light are blinking.



Cause	Solution
One of the following might have occurred. <ul style="list-style-type: none"><li>– The corresponding printhead is missing.</li><li>– The corresponding printhead is installed incorrectly.</li><li>– The corresponding printhead still has an orange plug or plastic tape on it.</li><li>– The corresponding printhead is incompatible or damaged.</li></ul>	<ul style="list-style-type: none"><li>– Make sure both printheads are properly installed.</li><li>– Install any missing printhead.</li><li>– If both printheads are installed, remove the printhead indicated, make sure there is no orange plug or plastic tape on it, and then reinsert the printhead securely.</li><li>– Make sure that you are using the correct HP printheads for your printer.</li></ul> <p><b>NOTE:</b> For more information, see <a href="#">Printhead (cartridge) problem on page 76</a>.</p> <p><b>NOTE:</b> Do not open the printhead latch unless instructed to do so.</p>

- The Alert icon, both Printhead icons, and the Ink/Printhead light are blinking.



Cause	Solution
One of the following might have occurred.	<ul style="list-style-type: none"> <li>– Make sure both printheads are properly installed.</li> </ul>
<ul style="list-style-type: none"> <li>– One or both printheads are missing.</li> </ul>	<ul style="list-style-type: none"> <li>– Install any missing printheads.</li> </ul>
<ul style="list-style-type: none"> <li>– One or both printheads are installed incorrectly.</li> </ul>	<ul style="list-style-type: none"> <li>– If both printheads are installed, remove the printheads, make sure there is no orange plug or plastic tape on them, and then reinsert the printheads securely.</li> </ul>
<ul style="list-style-type: none"> <li>– One or both printheads still have an orange plug or plastic tape on them.</li> </ul>	
<ul style="list-style-type: none"> <li>– One or both printheads are incompatible or damaged.</li> </ul>	<ul style="list-style-type: none"> <li>– Make sure that you are using the correct HP printheads for your printer.</li> </ul> <p><b>NOTE:</b> For more information, see <a href="#">Printhead (cartridge) problem on page 76</a>.</p> <p><b>NOTE:</b> Do not open the printhead latch unless instructed to do so.</p>

## Printhead Alignment icon

### Alignment status icon

- The Number Counter icon shows an A or a blinking A.

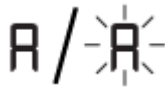

Cause	Solution
The printer is doing printhead alignment.	Once the alignment page is printed, place the printed page print-side down on the scanner glass, and then press one of the copy buttons on the control panel to scan the page.
A blinking "A" appears when the alignment page is being printed or scanned.	Printhead alignment is complete after the scan.
It stops blinking after the page is printed or scanned.	
"A" disappears after the scan when printhead alignment is complete.	<b>NOTE:</b> To learn how to load an original, see <a href="#">Load original on page 40</a> .

- The Number Counter icon shows a blinking A. The Alert icon, Resume light, and Power light are blinking.

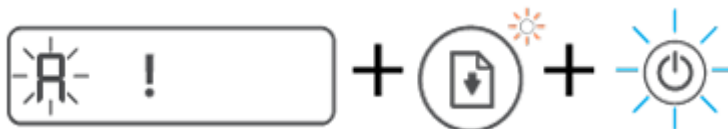

Cause	Solution
Printhead alignment failed. This occurs after you have scanned the alignment page.	<p>Try one of the following:</p> <ul style="list-style-type: none"> <li>– Press  (the Resume button) to reprint the alignment page.</li> <li>– Press one of the copy buttons to rescan the alignment page.</li> </ul> <p>If you do not do anything, printhead alignment gets canceled after some time.</p>

## Alert icon, Paper Error icon, and Resume light

- The Alert icon, the Paper Error icon, and the Resume light are on.



Cause	Solution
There is no paper in the input tray.	<p>Load paper in the input tray.</p> <p>For information about how to load paper, see <a href="#">Load media on page 21</a>.</p>

- The Alert icon, the Paper Error icon, and the Resume light are blinking.





Cause	Solution
The printer receives a printing job, and detects that there is no paper in the input tray.	Load paper, and then press  (the Resume button) to continue printing.

## Number Counter icon

- The Number Counter icon is showing E3. The Alert icon, the Ink/Printhead light, and the Resume light are blinking.



Cause	Solution
The carriage inside the printer has stalled.	<ol style="list-style-type: none"> <li>1. Open the front door, then the printhead access door.</li> <li>2. Make sure the printhead latch is properly closed and the print carriage is not obstructed. Do not open the printhead latch.</li> <li>3. Remove any jammed paper or other objects blocking the carriage.</li> <li>4. Close printhead access door and the front door.</li> <li>5. Press  (the Resume button) to continue printing or press  (the Cancel button). See <a href="#">Jams and paper-feed issues on page 68</a> for more information.</li> </ol>

- The Number Counter icon is showing E4. The Alert icon, and the Resume light are blinking.



Cause	Solution
There is a paper jam.	<p>Clear the jam, and then press  (the Resume button) to continue printing.</p> <p>For more information, see <a href="#">Jams and paper-feed issues on page 68</a>.</p> <p><b>CAUTION:</b> Do not open the printhead latch.</p>

- The Number Counter icon is showing E5.



Cause	Solution
The scanner is not working.	<p>Turn the printer off, and then on again.</p> <p>If the problem persists, contact HP. The printer still prints even if the scanner is not working.</p>

- The Number Counter icon is showing E6.



Cause	Solution
The printer is in an error state.	Reset the printer. <ol style="list-style-type: none"> <li>1. Turn off the printer.</li> <li>2. Unplug the power cord.</li> <li>3. Wait a minute, and then plug the power cord back in.</li> <li>4. Turn on the printer.</li> </ol> <p>If the problem persists, contact HP.</p>

## Ink icon, CMYK icon, and Ink/Printhead light

- The CMYK icons are on, and one or more Ink icons are blinking.

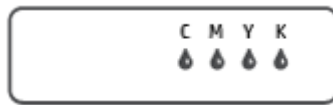

Cause	Solution
Ink tank is low on ink.	Refill the indicated ink tank that is low on ink.

- The CMYK icons are on, and one or more Ink icons are blinking. The Ink/Printhead light is on.

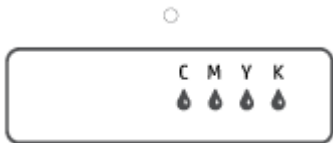

Cause	Solution
Ink tank is very low on ink.	Refill the indicated ink tank that is very low on ink.

- The Number Counter icon shows E7. The CMYK icons are on. The Ink/Printhead light, one or more Ink icons, and the Alert icon are blinking.



Cause	Solution
Ink tank is out of ink.	Refill the indicated ink tank that is out of ink.

# Change the paper settings

## To change the settings from the printer driver

- 1. Windows 10:** From the Windows **Start** menu, select **Windows System**, and then click **Control Panel**. Under **Hardware and Sound**, click **View Devices and Printers**.  
**Windows 7:** From the Windows **Start** menu, click **Devices and Printers**.
- 2.** Right-click the printer icon, and then select **Printing Preferences**.
- 3.** Click the **Paper/Quality** tab.
- 4.** From the **Media** drop-down list, select the appropriate paper type.
- 5.** Click the **Advanced** button. Then select the appropriate paper size from the **Paper Size** drop-down list.



## Paper basics

The printer is designed to work well with most types of office paper. It is best to test a variety of print paper types before buying large quantities. Use HP paper for optimum print quality. Visit the HP website at [www.hp.com](http://www.hp.com) for more information about HP paper.



HP recommends plain papers with the ColorLok logo for printing everyday documents. All papers with the ColorLok logo are independently tested to meet high standards of reliability and print quality, and produce documents with crisp, vivid color, bolder blacks, and that dry faster than ordinary plain papers. Look for papers with the ColorLok logo in a variety of weights and sizes from major paper manufacturers.

This section contains the following topics:

- [Recommended papers for printing](#)
- [Order HP paper supplies](#)

### Recommended papers for printing

If you want the best print quality, HP recommends using HP papers that are specifically designed for the type of project you are printing.

Depending on your country/region, some of these papers might not be available.

#### Photo printing

- **HP Premium Plus Photo Paper**

HP Premium Plus Photo Paper is HP's highest-quality photo paper for your best photos. With HP Premium Plus Photo Paper, you can print beautiful photos that are instant-dry so you can share them right off the printer. It is available in several sizes, including A4, 8.5 x 11 inches, 4 x 6 inches (10 x 15 cm), 5 x 7 inches (13 x 18 cm), and in two finishes - glossy or soft gloss (semi-gloss). Ideal for framing, displaying, or gifting your best photos and special photo projects. HP Premium Plus Photo Paper delivers exceptional results with professional quality and durability.

- **HP Advanced Photo Paper**

This glossy photo paper features an instant-dry finish for easy handling without smudging. It resists water, smears, fingerprints, and humidity. Your prints have a look and feel comparable to a store-processed photo. It is available in several sizes, including A4, 8.5 x 11 inches, 10 x 15 cm (4 x 6 inches), 13 x 18 cm (5 x 7 inches). It is acid-free for longer lasting documents.

- **HP Everyday Photo Paper**

Print colorful, everyday snapshots at a low cost, using paper designed for casual photo printing. This affordable photo paper dries quickly for easy handling. Get sharp, crisp images when you use this paper with any inkjet printer. It is available in glossy finish in several sizes, including A4, 8.5 x 11 inches, 5 x 7 inches, and 4 x 6 inches (10 x 15 cm). It is acid-free for longer lasting documents.

- **HP Photo Value Packs**

HP Photo Value Packs conveniently package original HP ink cartridges and HP Advanced Photo Paper to save you time and take the guesswork out of printing affordable, lab-quality photos with your HP

printer. Original HP inks and HP Advanced Photo Paper have been designed to work together so your photos are long lasting and vivid, print after print. Great for printing out an entire vacation's worth of photos or multiple prints to share.

### Business documents

- **HP Premium Presentation Paper 120g Matte or HP Professional Paper 120 Matt**

This paper is a heavy two-sided matte paper perfect for presentation, proposals, reports, and newsletters. It is heavyweight for an impressive look and feel.

- **HP Brochure Paper 180g Glossy or HP Professional Paper 180 Glossy**

These papers are glossy-coated on both sides for two-sided use. They are the perfect choice for near-photographic reproductions and business graphics for report covers, special presentations, brochures, mailers, and calendars.

- **HP Brochure Paper 180g Matte or HP Professional Paper 180 Matte**

These papers are matte-coated on both sides for two-sided use. They are the perfect choice for near-photographic reproductions and business graphics for report covers, special presentations, brochures, mailers, and calendars.

### Everyday printing

All the papers listed for everyday printing feature ColorLok Technology for less smearing, bolder blacks, and vivid colors.

- **HP Bright White Inkjet Paper**

HP Bright White Inkjet Paper delivers high-contrast colors and sharp text. It is opaque enough for two-sided color usage with no show-through, which makes it ideal for newsletters, reports, and flyers.

- **HP Printing Paper**

HP Printing Paper is a high-quality multifunction paper. It produces documents that look and feel more substantial than documents printed on standard multipurpose or copy paper. It is acid-free for longer lasting documents.

- **HP Office Paper**

HP Office Paper is a high-quality multifunction paper. It is suitable for copies, drafts, memos, and other everyday documents. It is acid-free for longer lasting documents.

- **HP Office Recycled Paper**

HP Office Recycled Paper is a high-quality multifunction paper made with 30% recycled fiber.

## Order HP paper supplies

The printer is designed to work well with most types of office paper. Use HP paper for optimum print quality.

To order HP papers and other supplies, go to [www.hp.com](http://www.hp.com). At this time, some portions of the HP website are available in English only.

HP recommends plain papers with the ColorLok logo for printing and copying of everyday documents. All papers with the ColorLok logo are independently tested to meet high standards of reliability and print quality, and produce documents with crisp, vivid color, bolder blacks and shorter dry-time than ordinary plain papers. Look for papers with the ColorLok logo in a variety of weights and sizes from major paper manufacturers.

## Open the HP printer software

You can use the HP printer software to configure the printer settings, check estimated ink levels, order printing supplies, maintain the printer, resolve printing issues, and more. More information about the available printer software options is provided throughout this guide.

After completing the hardware setup, visit [123.hp.com](https://123.hp.com) on your computer, if you have not installed the HP printer software.



### NOTE:

- If you are using the HP Smart app instead of the printer software, see [Use the HP Smart app to print, scan, and troubleshoot on page 16](#).
- Each device must have the app or software installed in order to print.
- The HP printer software is supported on Windows 7, Windows 10, and macOS 10.12 to 10.14 devices.

---

After installing the HP printer software, do one of the following:

- **Windows 10:** From the computer desktop, click **Start**, select **HP** from the app list, and then select the icon with the printer name.
- **Windows 7:** From the computer desktop, click **Start**, select **All Programs**, click **HP**, click the folder for the printer, and then select the icon with the printer name.
- **Mac:** From the **Applications** folder, open the **HP** folder, and then double-click **HP Utility**.

## Use the HP Smart app to print, scan, and troubleshoot

HP Smart helps you to set up, scan, print, share, and manage your HP printer. You can share documents and images through email, text messages, and popular cloud and social media services (such as iCloud, Google Drive, Dropbox, and Facebook). You can also set up new HP printers, as well as monitor and order supplies.



**NOTE:** The HP Smart app is supported on Windows 10 for the printer. The app might not be available in all languages. Some features might not be available with all printer models.

- For basic instructions on how to print, scan, and troubleshoot using HP Smart, see [Print using the HP Smart app \(Windows 10\) on page 30](#), [Scan using the HP Smart app \(Windows 10\) on page 41](#), and [Get help from the HP Smart app on page 67](#). For more information, you can also visit [www.hp.com/go/hpsmartwin-help](http://www.hp.com/go/hpsmartwin-help).

### To install the HP Smart app on Windows 10 and connect to your printer

1. To get the HP Smart app, visit [123.hp.com](http://123.hp.com) or the device app store to download and install the app.
2. After installation, click **Start** from the computer desktop.
3. To connect to your printer make sure your printer and device are turned on and connected.
4. Open the HP Smart app on your device.
5. On the Home screen of HP Smart, click **+** (Plus icon), and then select or add a printer.

Follow the onscreen instructions to complete the connection.

## Sleep mode

- Power usage is reduced while in Sleep mode.
- After initial setup of printer, the printer will enter Sleep mode after 5 minutes of inactivity.
- The Power button light is dimmed and the printer control panel display is off in Sleep mode.
- Pressing any button on the control panel, or sending a print or scan job can wake up the printer from sleep mode.

# Quiet Mode

Quiet Mode slows down printing to reduce overall noise without affecting print quality. Quiet Mode only works for printing with **Normal** print quality on plain paper. To reduce printing noise, turn on Quiet Mode. To print at normal speed, turn Quiet Mode off. Quiet Mode is off by default.

---

 **NOTE:** In Quiet Mode, if you print on plain paper with the **Draft** or **Best** print quality, or if you print photos or envelopes, the printer works in the same way as when Quiet Mode is off.

---

## To turn Quiet Mode on or off from the printer software (Windows)

1. Open the HP printer software. For more information, see [Open the HP printer software on page 15](#).
2. Click the **Quiet Mode** tab.

---

 **NOTE:** The Quiet mode tab is available only if the printer is connected from the HP printer software.

---

3. Click **On** or **Off**.
4. Click **Save Setting**.

## To turn Quiet Mode on or off from the printer software (macOS)

1. Open HP Utility.

---

 **NOTE:** HP Utility is located in the **HP** folder in the **Applications** folder.

---

2. Select the printer.
3. Click **Quiet Mode**.
4. Select **On** or **Off**.
5. Click **Apply Now**.

## Auto-Off

This feature turns the printer off after 2 hours of inactivity to help reduce energy use. Auto-Off turns the printer off completely, so you must use the Power button to turn the printer back on.

If your printer supports this energy saving feature, Auto-Off is automatically enabled or disabled depending on printer capabilities and connection options. Even when Auto-Off is disabled, the printer enters Sleep mode after 5 minutes of inactivity to help reduce energy use.

- Auto-Off is enabled when the printer is turned on, if the printer does not have network, fax or Wi-Fi Direct capability, or is not using these capabilities.
- Auto-Off is disabled when a printer's wireless or Wi-Fi Direct capability is turned on or when a printer with fax, USB, or Ethernet network capability establishes a fax, USB, or Ethernet network connection.

---

 **TIP:** To conserve battery power, you can enable Auto-Off, even when the printer is connected or wireless is turned on.

---

---

## 2 Print

- [Load media](#)
- [Print documents](#)
- [Print photos](#)
- [Print envelopes](#)
- [Print using the HP Smart app \(Windows 10\)](#)
- [Print using the maximum dpi](#)
- [Tips for print success](#)
- [View print job status and manage print jobs \(Windows\)](#)
- [Customize your printer \(Windows\)](#)



# Load media

## To load paper

1. Raise the input tray.

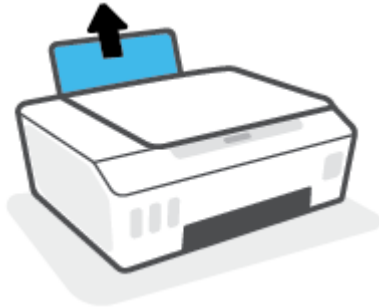

2. Slide the paper-width guide to the left.

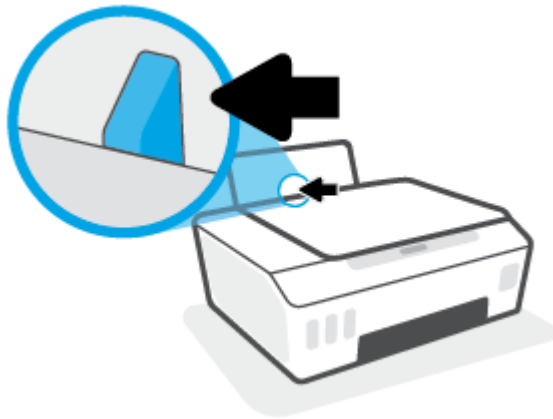

3. Insert a stack of paper into the input tray with the short edge down and the print-side up, and slide the stack of paper down until it stops.

If you are loading small-size paper (like photo paper), make sure the paper stack is aligned with the far-right side of the tray.

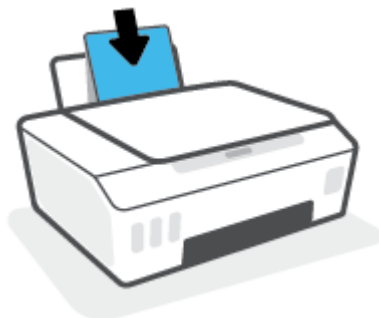

4. Slide the paper-width guide to the right until it stops at the edge of the paper.

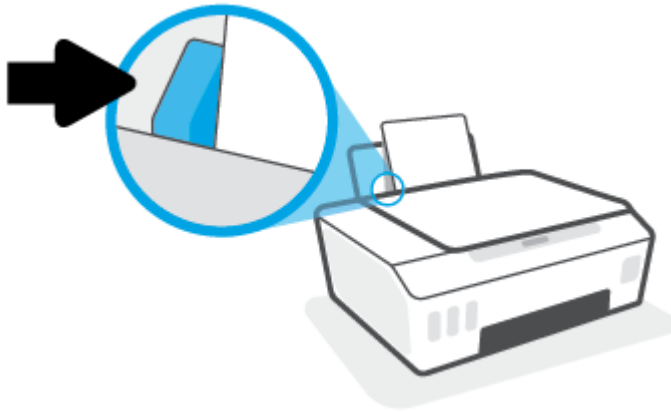

5. Pull out the output tray and the tray extender.



### To load envelopes

1. Raise the input tray.

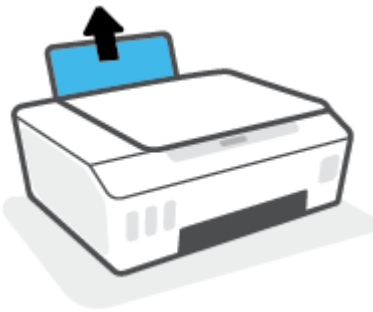

2. Slide the paper-width guide to the left.

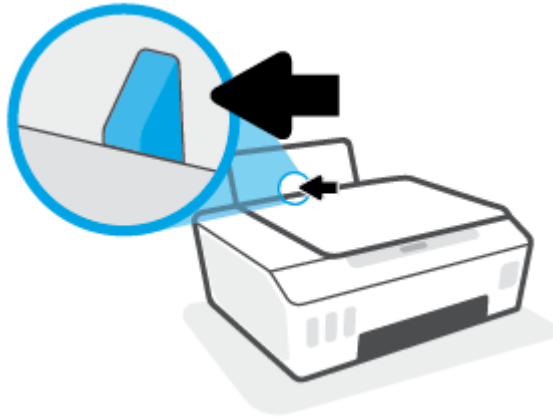

3. Insert one or more envelopes into the far-right side of the input tray and slide the stack of envelopes down until it stops.

The side to be printed on should face up.

- a. For envelope with flap on the long edge, insert the envelope vertically with the flap on the left side and facing down.

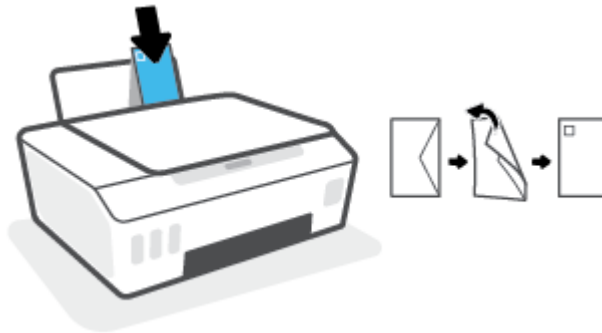

- b. For envelope with the flap on the short edge, insert the envelope vertically with the flap on the top and facing down.

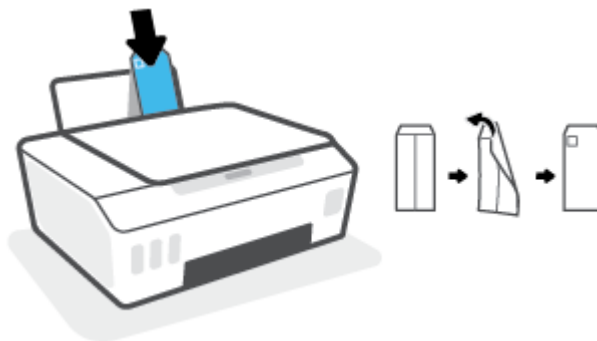

4. Slide the paper-width guide to the right against the stack of envelopes until it stops.

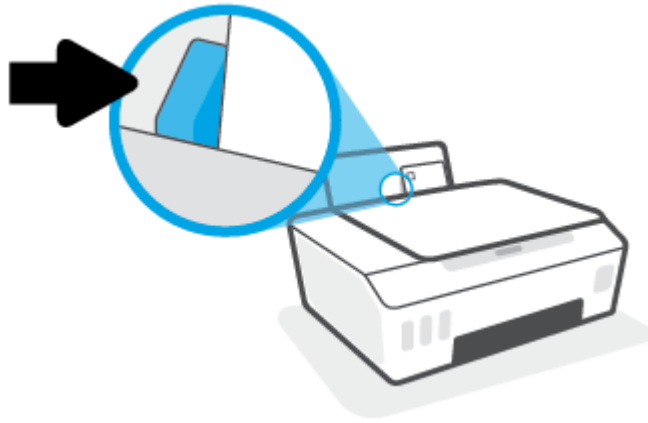

5. Pull out the output tray and the tray extender.



# Print documents

Before printing documents, make sure you have paper loaded in the input tray and the output tray is open. For more information about loading paper, see [Load media on page 21](#).

## To print a document (Windows)

1. From the **File** menu in your software, select **Print**.
2. Make sure your printer is selected.
3. Click the button that opens the **Properties** dialog box.

Depending on your software application, this button might be called **Properties**, **Options**, **Printer Setup**, **Printer Properties**, **Printer**, or **Preferences**.

4. Select the appropriate options on the **Printing Shortcuts** or **Printing Shortcut** tab.

To change other print settings, click the other tabs.

To learn more about the options in the printer driver, hover your mouse over each option to view the tooltips.



---

**NOTE:** If you change the paper size, be sure to load the correct paper in the input tray.

---

5. Click **OK** to close the **Properties** dialog box.
6. Click **Print** or **OK** to begin printing.

## To print documents (macOS)

1. From the **File** menu in your software, choose **Print**.
2. Make sure your printer is selected.
3. Set the print options.

If you do not see options on the Print dialog, click **Show Details**.

- Choose the appropriate paper size in the **Paper Size** pop-up menu.



---

**NOTE:** If you change the paper size, ensure that you have loaded the correct paper.

---

- Select the orientation.
  - Enter the scaling percentage.
4. Click **Print**.

## To print on both sides of the page (Windows)

1. From the **File** menu in your software, select **Print**.
2. Make sure your printer is selected.
3. Click the button that opens the **Properties** dialog box.

Depending on your software application, this button might be called **Properties**, **Options**, **Printer Setup**, **Printer Properties**, **Printer**, or **Preferences**.

4. On the **Printing Shortcuts** or **Printing Shortcut** tab, select the **Two-sided (Duplex) Printing** shortcut, and then select an option from the **Print On Both Sides Manually** drop-down list.

To change other print settings, click the other tabs.

To learn more about the options in the printer driver, hover your mouse over each option to view the tooltips.



**NOTE:** If you change the paper size, be sure to load the correct paper in the input tray.

---

5. Click **OK** to close the **Properties** dialog box.
6. Click **Print** or **OK** to begin printing.

### To print on both sides of the page (macOS)

1. From the **File** menu in your software, choose **Print**.
2. In the Print dialog, choose **Paper Handling** from the pop-up menu and set **Page Order** to **Normal**.
3. Set **Pages to Print** to **Odd Only**.
4. Click **Print**.
5. After all of the odd numbered pages have printed, remove the document from the output tray.
6. Reload the document so that the end that came out of the printer is now going into the printer and the blank side of the document is facing toward the front of the printer.
7. In the Print dialog, return to the **Paper Handling** pop-up menu and set the page order to **Normal** and the pages to print to **Even Only**.
8. Click **Print**.

# Print photos

Before printing photos, make sure you have photo paper loaded in the input tray and the output tray is open. For more information about loading paper, see [Load media on page 21](#).

## To print a photo on photo paper (Windows)

1. From the **File** menu in your software, select **Print**.
2. Make sure your printer is selected.
3. Click the button that opens the **Properties** dialog box.

Depending on your software application, this button might be called **Properties**, **Options**, **Printer Setup**, **Printer Properties**, **Printer**, or **Preferences**.

4. Select the appropriate options on the **Printing Shortcuts** or **Printing Shortcut** tab.

To change other print settings, click the other tabs.

To learn more about the options in the printer driver, hover your mouse over each option to view the tooltips.

---

 **NOTE:** If you change the paper size, be sure to load the correct paper in the input tray.

---

5. Click **OK** to close the **Properties** dialog box.
6. Click **Print** or **OK** to begin printing.

---

 **NOTE:** After the printing is finished, remove unused photo paper from the input tray. Store the photo paper so it does not start to curl, which could reduce the quality of your printout.

---

## To print a photo from the computer (macOS)

1. From the **File** menu in your software, choose **Print**.
2. Make sure your printer is selected.
3. Set the print options.

If you do not see options on the Print dialog, click **Show Details**.

- Choose the appropriate paper size in the **Paper Size** pop-up menu.

---

 **NOTE:** If you change the paper size ensure that you have loaded the correct paper.

---

- Select the orientation.
4. From the pop-up menu, choose **Paper Type/Quality**, and then choose the following settings:
    - **Paper Type:** The appropriate photo paper type
    - **Quality:** Select the option that provides the best quality or maximum dpi.
    - Click the **Color Options** disclosure triangle, and then choose the appropriate **Photo Fix** option.

- **Off:** applies no changes to the image.
  - **On:** automatically focuses the image; moderately adjusts image sharpness.
5. Select any other print settings you want, and then click **Print**.



# Print envelopes

Before printing envelopes, make sure you have envelopes loaded in the input tray and the output tray is open. You can load one or more envelopes into the input tray. Do not use shiny or embossed envelopes or envelopes that have clasps or windows. For more information about loading envelopes, see [Load media on page 21](#).



---

**NOTE:** For details on how to format text for printing on envelopes, refer to the documentation of the application that you are using.

---

## To print an envelope (Windows)

1. From the **File** menu in your software, select **Print**.
2. Make sure your printer is selected.
3. Click the button that opens the **Properties** dialog box.

Depending on your software application, this button might be called **Properties**, **Options**, **Printer Setup**, **Printer Properties**, **Printer**, or **Preferences**.

4. Select the appropriate options on the **Printing Shortcuts** or **Printing Shortcut** tab.

To change other print settings, click the other tabs.

To learn more about the options in the printer driver, hover your mouse over each option to view the tooltips.



---

**NOTE:** If you change the paper size, be sure to load the correct paper in the input tray.

---

5. Click **OK** to close the **Properties** dialog box.
6. Click **Print** or **OK** to begin printing.

## To print envelopes (macOS)

1. From the **File** menu in your software, choose **Print**.
2. Make sure your printer is selected.
3. Select the appropriate envelope size from the **Paper Size** pop-up menu.

If you do not see options on the Print dialog, click **Show Details**.



---

**NOTE:** If you change the paper size, ensure that you have loaded the correct paper.

---

4. From the pop-up menu, choose **Paper Type/Quality**, and verify the paper type setting is set to **Plain Paper**.
5. Click **Print**.

# Print using the HP Smart app (Windows 10)

This section provides basic instructions for using the HP Smart app to print from your device. For more information about the app, see [Use the HP Smart app to print, scan, and troubleshoot on page 16](#).

## To begin using the HP Smart app to print

1. Load paper in the input tray. For more information, see [Load media on page 21](#).
2. Open the HP Smart app on your device.
3. On the Home screen of HP Smart, make sure your printer is selected.

 **TIP:** If a printer is already set up, you can select it from the Home screen of HP Smart by swiping left or right and selecting it.

To use a different printer, click or tap **+** (Plus icon) on the Home screen, and then select a different printer or add a new printer.

---

## To print from a Windows 10 device

1. On the Home screen of HP Smart, do one of the following:
  - Select **Print Photo**, locate a photo you want to print, and then click or tap **Select Photos to Print**.
  - Select **Print Document**, locate a PDF document you want to print, and then click or tap **Print**.
2. Select the appropriate options. To view more settings, click or tap **More settings**.

For more information about printing settings, see [Tips for print success on page 33](#).

3. Click or tap **Print** to begin printing.

# Print using the maximum dpi

Use maximum dots per inch (dpi) to print high-quality, sharp images on photo paper.

Printing in maximum dpi takes longer than printing with other settings and requires a large amount of disk space.

For supported print resolutions, visit the printer support website at [www.support.hp.com](http://www.support.hp.com).

## To print in maximum dpi mode (Windows)

1. From your software, select **Print**.
2. Make sure your printer is selected.
3. Click the button that opens the **Properties** dialog box.

Depending on your software application, this button might be called **Properties**, **Options**, **Printer Setup**, **Printer Properties**, **Printer**, or **Preferences**.

4. Select the appropriate options.

### Windows 10

- Click the **Paper/Quality** tab. From the **Paper Size** drop-down list, select the appropriate paper size. From the **Paper Type** drop-down list, select the appropriate paper type.
- Click the **Advanced** tab, and then select **Print in Max DPI**.

### Windows 7

- Click the **Paper/Quality** tab. From the **Media** drop-down list, select the appropriate paper type.
- Click the **Advanced** button. Select the appropriate paper size from the **Paper Size** drop-down list. In the **Printer Features** area, select **Yes** from the **Print in Max DPI** drop-down list. Then click **OK** to close the **Advanced Options** dialog.

For more printing tips, see [Printer settings tips on page 33](#).

5. Confirm the orientation on the **Layout** tab, and then click **OK** to print.

## To print using maximum dpi (macOS)

1. From the **File** menu in your software, choose **Print**.
2. Make sure your printer is selected.
3. Set the print options.

If you do not see options on the Print dialog, click **Show Details**.

- Choose the appropriate paper size in the **Paper Size** pop-up menu.



**NOTE:** If you change the paper size ensure that you have loaded the correct paper.

- Select the orientation.
4. From the pop-up menu, choose **Paper Type/Quality**, and then choose the following settings:

- **Paper Type:** The appropriate paper type
  - **Quality: Maximum dpi**
5. Select any other print settings that you want, and then click **Print**.

# Tips for print success

- [Paper loading tips](#)
- [Printer settings tips](#)

To print successfully, the HP printheads should be functioning properly, the ink tanks should be filled with sufficient ink, the paper should be loaded correctly, and the printer should have the appropriate settings. For more information, see [Tips for working with ink and printhead on page 59](#).

Print settings do not apply to copying or scanning.

## Paper loading tips

- Load a stack of paper (not just one page). All of the paper in the stack should be in the same size and type to avoid a paper jam.
- Load the paper with side to be printed on facing up.
- Ensure that paper loaded in the input tray lays flat, and the edges are not bent or torn.
- Adjust the paper-width guide in the input tray to fit snugly against all paper. Make sure the paper-width guide does not bend the paper in the input tray.

For more information, see [Load media on page 21](#).

## Printer settings tips

### Printer settings tips (Windows)

- To change default print settings, open the HP printer software, click **Print & Scan**, and then click **Set Preferences**. For information how to open the printer software, see [Open the HP printer software on page 15](#).

---

 **TIP:** To learn more about the options in the printer driver, hover your mouse over each option to view the tooltips.

---

- You can use printing shortcuts to save time setting desired printing preferences. A printing shortcut stores the settings that are appropriate for a particular type of job, so that you can set all the options with a single click. To use a shortcut, go to the **Printing Shortcuts** or **Printing Shortcut** tab, select the desired shortcut, and then click **OK**.

To add a new printing shortcut, set the desired printing preferences on the **Paper/Quality**, **Layout**, or **Advanced** tab, select the **Printing Shortcuts** or **Printing Shortcut** tab, click **Save As** and enter a name, and then click **OK**.

To delete a printing shortcut, select it, and then click **Delete**.

---

 **NOTE:** You cannot delete the default printing shortcuts.

---

- To understand paper and paper tray settings:
  - **Paper Size:** Select the paper size you loaded in the input tray.
  - **Paper Source:** Select the paper tray you loaded the paper into.
  - **Paper Type** or **Media:** Select the paper type you are using.

- To understand color or black and white settings:
  - **Color:** Uses black and color ink for full color prints.
  - **Black & White** or **Black Ink Only:** Uses the black ink only for normal or lower quality black and white prints.
  - **High Quality Grayscale:** Uses black and color ink to produce a wider range of black and grey tones for high quality black and white prints.
  
- To understand print quality settings:
 

The print quality is measured in print resolution dots per inch (dpi). Higher dpi produces clearer and more detailed prints, but slows print speed and might use more ink.

  - **Draft:** Lowest dpi typically used when ink levels are low or when high quality prints are not needed.
  - **Normal:** Suitable for most print jobs.
  - **Best:** Better dpi than **Normal**.
  - **Print in Max DPI:** Highest dpi setting available for print quality.
  - **HP Real Life Technologies:** This feature smooths and sharpens images and graphics for improved print quality.
  
- To understand page and layout settings:
  - **Orientation:** Select **Portrait** for vertical prints or **Landscape** for horizontal prints.
  - **Print on Both Sides Manually:** Manually flip the pages after one side of the paper prints out so that you can print on both sides of the paper.
    - **Flip on Long Edge:** Select it if you want to flip pages by the long edge of the paper when printing on both sides of the paper.
    - **Flip on Short Edge:** Select it if you want to flip pages by the short edge of the paper when printing on both sides of the paper.
  - **Booklet Layout** or **Booklet:** Allows you to print a multiple-page document as a booklet. It places two pages on each side of a sheet that can then be folded into a booklet in half size of the paper.
    - **Left binding** or **Booklet-LeftBinding:** The binding side after folded into a booklet appears at the left side. Select this option if your reading habit is from left to right.
    - **Right binding** or **Booklet-RightBinding:** The binding side after folded into a booklet appears at the right side. Select this option if your reading habit is from right to left.
  - **Borderless** or **Page Borders:** Allows you to add or remove borders to the pages if you print the document with two or more pages per sheet.
  - **Pages per Sheet Layout:** Helps you specify the order of the pages if you print the document with more than two pages per sheet.
  - **Pages to Print:** Allows you to print the odd pages only, print the even pages only, or print all pages.
  - **Reverse page order** or **Page Order:** Allows you to print pages from front to back or in reverse order.

### Printer settings tips (macOS)

- On the Print dialog, use the **Paper Size** pop-up menu to select the size of paper loaded in the printer.
- On the Print dialog, choose the **Paper Type/Quality** pop-up menu and select the appropriate paper type and quality.
- To print a black and white document using only black ink, choose the **Paper Type/Quality** from the pop-up menu and choose **Grayscale** from the Color pop-up menu.

## View print job status and manage print jobs (Windows)

To view, pause, or cancel your print jobs, open the HP printer software (available from the **Start** menu), click **Print & Scan** , and then click **See What's Printing**.



## Customize your printer (Windows)

To change the printer name, security settings, or other properties, open the HP printer software (available from the **Start** menu), click **Print & Scan** , and then click **Customize Your Printer**.

---

## 3 Copy and scan



- [Copy documents](#)
- [Load original](#)
- [Scan using the HP Smart app \(Windows 10\)](#)
- [Scan using the HP printer software](#)
- [Tips for successful scanning and copying](#)

# Copy documents

 **NOTE:** All documents are copied in normal quality print mode. You cannot change the print mode quality when copying.







For information on HP Smart app, see [Use the HP Smart app to print, scan, and troubleshoot on page 16](#).

## To copy documents

1. Load paper in the input tray.  
For information about how to load paper, see [Load media on page 21](#).
2. Load the original print-side down near the icon at the corner of the scanner glass.  
For more information, see [Load original on page 40](#).
3. Press either  (the Black Copy button) or  (the Color Copy button) to make a copy.  
Copying will start two seconds after the last button press.

 **TIP:** You can increase the number counter by pressing, and holding a copy button.

## To change the paper settings when copying

Current paper type	Do this	To change to this paper type	Printer display shows this icon
Plain paper	Press and hold both copy buttons (   ) at the same time for three seconds.	Photo paper	
Photo paper	Press and hold both copy buttons (   ) at the same time for three seconds.	Plain paper	

## Load original

To load an original on the scanner glass

1. Lift the scanner lid.

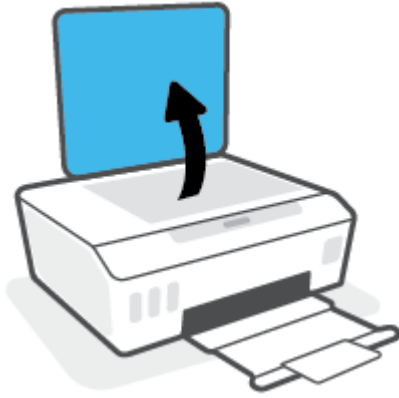

2. Load the original print-side down near the icon at the corner of the scanner glass.

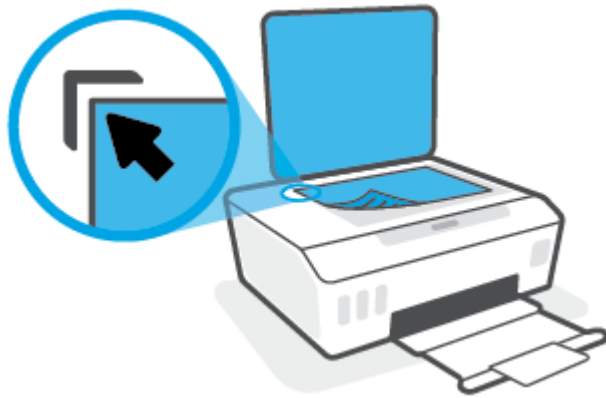

3. Close the scanner lid.



# Scan using the HP Smart app (Windows 10)

This section provides basic instructions for using the HP Smart app to scan from your device. For more information about the app, see [Use the HP Smart app to print, scan, and troubleshoot on page 16](#).

## Scan from a Windows 10 device

### To scan a document or photo using the printer scanner

1. Load the original print-side down near the icon at the corner of the scanner glass on the printer.
2. Open HP Smart. For more information, see [Use the HP Smart app to print, scan, and troubleshoot on page 16](#).
3. Select **Scan**, and then select **Scanner**.
4. Click or tap the Settings icon to modify the basic settings.  
Select Glass from the **Source** drop-down list.
5. Click or tap the Preview icon to preview and adjust the image if necessary.
6. Click or tap the Scan icon.
7. Make other adjustments if necessary:
  - Click or tap **Add Pages** to add more documents or photos.
  - Click or tap **Edit** to rotate or crop the document or image, or adjust its contrast, brightness, saturation, or angle.
8. Select the file type you want, and then click or tap the Save icon to save it or click or tap the Share icon to share it with others.

### To scan a document or photo using the device camera

If your device has a camera, you can use the HP Smart app to scan a printed document or photo with the device camera. You can then use HP Smart to edit, save, print or share the image.

1. Open HP Smart. For more information, see [Use the HP Smart app to print, scan, and troubleshoot on page 16](#).
2. Select **Scan**, and then select **Camera**.
3. Put a document or photo in front of the camera, and then click or tap the round button at the bottom of the screen to take an image.
4. Adjust boundaries if needed. Click or tap the Apply icon.
5. Make other adjustments if necessary:
  - Click or tap **Add Pages** to add more documents or photos.
  - Click or tap **Edit** to rotate or crop the document or image, or adjust its contrast, brightness, saturation, or angle.
6. Select the file type you want, and then click or tap the Save icon to save it or click or tap the Share icon to share it with others.

## To edit a previously scanned document or photo

HP Smart provides editing tools, such as crop and rotate, which you can use to adjust a previously scanned document or photo on your device.

1. Open HP Smart. For more information, see [Use the HP Smart app to print, scan, and troubleshoot on page 16](#).
2. Select **Scan**, and then select **Import**.
3. Select the document or photo that you want to adjust, and then click or tap **Open**.
4. Adjust boundaries if needed. Click or tap the Apply icon.
5. Make other adjustments if necessary:
  - Click or tap **Add Pages** to add more documents or photos.
  - Click or tap **Edit** to rotate or crop the document or image, or adjust its contrast, brightness, saturation, or angle.
6. Select the file type you want, and then click or tap **Save** or **Share** to save the file or share it with others.

# Scan using the HP printer software

- [Scan from a computer](#)
- [Change scan settings \(Windows\)](#)
- [Create a new scan shortcut \(Windows\)](#)

## Scan from a computer

Before scanning from a computer, make sure you have already installed the HP recommended printer software. The printer and computer must be connected and turned on.

### To scan a document or photo to a file (Windows)

1. Load the original print-side down near the icon at the corner of the scanner glass.
2. In the HP printer software (available from the **Start** menu), click **Scan** , and then click **Scan a Document or Photo** .
3. Select the type of scan you want and then click **Scan** .
  - Choose **Save as PDF** to save the document (or photo) as a PDF file.
  - Choose **Save as JPEG** to save the photo (or document) as an image file.



**NOTE:** Click the **More** link at the top right corner of the Scan dialog to review and modify settings for any scan.

For more information, see [Change scan settings \(Windows\) on page 44](#).

If **Show Viewer After Scan** is selected, you can make adjustments to the scanned image in the preview screen.

---

### To scan a document or photo to email (Windows)

1. Load the original print-side down near the icon at the corner of the scanner glass.
2. In the HP printer software, available from the **Start** menu, click **Scan** , and then click **Scan a Document or Photo** .
3. Select the type of scan you want and then click **Scan** .

Choose **Email as PDF** or **Email as JPEG** to open your email software with the scanned file as an attachment.



**NOTE:** Click the **More** link at the top right corner of the Scan dialog to review and modify settings for any scan.

For more information, see [Change scan settings \(Windows\) on page 44](#).

If **Show Viewer After Scan** is selected, you can make adjustments to the scanned image in the preview screen.

---

## To scan an original from HP printer software (macOS)

1. Open HP Easy Scan.  
HP Easy Scan is located in the **Applications** folder.
2. Choose the type of scan profile you want.
3. Click **Scan**.

## Change scan settings (Windows)

You can modify any of the scan settings either for a singular use or save the changes to use permanently. These settings include options such as page size and orientation, scan resolution, contrast, and the folder location for saved scans.

1. Load the original print-side down near the icon at the corner of the scanner glass.
2. In the HP printer software, available from the **Start** menu, click **Scan** , and then click **Scan a Document or Photo** .
3. Click the **More** link in the top right corner of the HP Scan dialog.

The detailed settings pane appears on the right. The left column summarizes the current settings for each section. The right column allows you to change the settings in the highlighted section.

4. Click each section at the left of the detailed settings pane to review the settings in that section.

You can review and change most settings using drop-down menus.

Some settings allow greater flexibility by displaying a new pane. These are indicated by a + (plus sign) at the right of the setting. You must either click **OK** to accept or click **Cancel** to cancel any changes on this pane to return to the detailed settings pane.

5. When you have finished changing settings, do one of the following:
  - Click **Scan** . You are prompted to save or reject the changes to the shortcut after the scan is finished.
  - Click the save icon to the right of the shortcut, and then click **Scan** .

## Create a new scan shortcut (Windows)

You can create your own scan shortcut to make scanning easier. For example, you might want to regularly scan and save photos in PNG format, rather than JPEG.

1. Load the original print-side down near the icon at the corner of the scanner glass.
2. In the HP printer software, available from the **Start** menu, click **Scan** , and then click **Scan a Document or Photo** .
3. Click **Create New Scan Shortcut** .



4. Enter a descriptive name, choose an existing shortcut on which to base your new shortcut, and then click **Create** .

For example, if you are creating a new shortcut for photos, choose either **Save as JPEG** or **Email as JPEG** . This makes available the options for working with graphics when scanning.

5. Change the settings for your new shortcut to meet your needs, and then click the save icon to the right of the shortcut.



**NOTE:** Click the **More** link at the top right corner of the Scan dialog to review and modify settings for any scan.

For more information, see [Change scan settings \(Windows\) on page 44](#).

---

## Tips for successful scanning and copying

Use the following tips to copy and scan successfully:

- Keep the glass and the back of the lid clean. The scanner interprets anything it detects on the glass as part of the image.
- Load the original print-side down near the icon at the corner of the scanner glass.
- To make a large copy of a small original, scan the original into the computer, resize the image in the scanning software, and then print a copy of the enlarged image.
- To avoid incorrect or missing scanned text, make sure the brightness is set appropriately in the software.

---

# 4 Manage ink and printhead

This section contains the following topics:

- [Ink levels](#)
- [Refill ink tanks](#)
- [Order ink supplies](#)
- [Print with black ink only](#)
- [Improve print quality](#)
- [Align printheads](#)
- [Clean printheads](#)
- [Clean printer](#)
- [Tips for working with ink and printhead](#)
- [Move printer](#)

# Ink levels

You can check the ink levels from the ink tanks on the printer. You can also check the HP printer software to determine when the tanks need to be refilled.

## To check the ink levels from the printer software (Windows)

1. In the HP printer software (available from the **Start** menu), click **Estimated Levels** at the top of the window.
2. In the Toolbox, click the **Estimated Levels** tab.

## To check the ink levels from the HP printer software (macOS)

1. Open HP Utility.



---

**NOTE:** HP Utility is located in the **HP** folder in the **Applications** folder.

---

2. Select the printer from the list of devices at the left of the window.
3. Click **Supplies Status**.  
The estimated ink levels appear.
4. Click **All Settings** to return to the **Information and Support** pane.

## Refill ink tanks

 **NOTE:** Product service or repairs required as a result of filling the ink tanks improperly and/or using non-HP ink will not be covered under warranty.

---

### To refill the ink tanks

1. Open the front door.

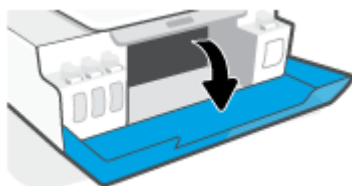

2. Open the cap of the ink tank you plan to refill.

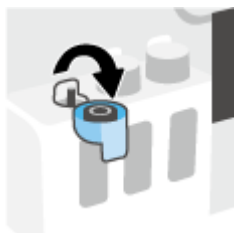

3. Depending on the type of ink bottles you have, do one of following:

- **Screw-cap bottles:** Twist to remove the cap of the ink bottle.



- **Flip-cap bottles:** Twist to remove the cap of the ink bottle, remove the seal from the bottle, install the cap back onto the bottle, and then pull open the top part of the cap.

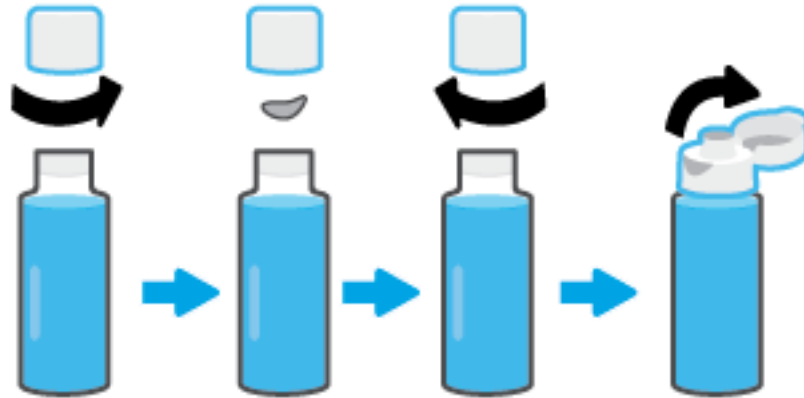

4. Match the color of the ink bottle with the color of the ink tank. Hold the bottle on the tank nozzle, making sure the tip of the bottle fits properly over the nozzle, and let the ink drain into the tank until the tank is full. If the ink does not drain immediately, remove the bottle and properly reinsert it on the tank.

---

 **NOTE:** Do not squeeze the ink bottles when filling ink. The ink bottles you have might vary.

---

**Screw-cap bottles**



**Flip-cap bottles**





---

 **NOTE:** If there is leftover ink in the bottle, store the bottle in an upright position in a cool and dry location.

---

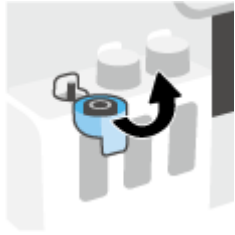

5. Close the ink tank cap securely.



6. Repeat steps 2 to 5 to refill other ink tanks.

7. Close the front door of the printer.

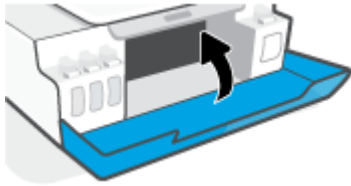

### Precautions for working with ink bottles

Use the following tips to work with ink bottles:

- Keep the ink bottles beyond the reach of children.
- Open the ink bottles only when you plan to fill the ink tanks.
- Do not tilt, shake, or squeeze the ink bottle when it is open to prevent ink leaks.
- Store the ink bottles in a cool, dark place.
- Do not drink or place in mouth.

## Order ink supplies

Before ordering ink bottles, visually check the labels on the ink bottles to locate the ink bottle numbers. You can also find this information on the product label located on the inside of the front door.

To order original HP supplies for the printer, go to [www.hp.com/buy/supplies](http://www.hp.com/buy/supplies) . If prompted, choose your country/region, and then follow the prompts to find the right ink bottles for your printer.



**NOTE:** Ordering ink bottles online is not supported in all countries/regions. If it is not available in your country/region, you may still view supplies information and print a list for reference when shopping at a local HP reseller.

---



# Print with black ink only

## To print with black ink only (Windows)

1. From your software, select **Print**.
2. Make sure your printer is selected.
3. Click the button that opens the **Properties** dialog box.

Depending on your software application, this button might be called **Properties**, **Options**, **Printer Setup**, **Printer Properties**, **Printer**, or **Preferences**.

4. Select the appropriate options.

### Windows 10

- Click **Paper/Quality** tab.
- Under **Print in Grayscale**, select **Black Ink Only** from the list, and then click **OK**.

### Windows 7

- On the **Layout** or **Paper/Quality** tab, click the **Advanced** button to open the **Advanced Options** dialog box.
- From the **Print in Grayscale** drop-down list, select **Black Ink Only**, and then click **OK**.

## To print with black ink only (macOS)

1. From the **File** menu in your software, choose **Print**.
2. Make sure your printer is selected.
3. Set the print options.

If you do not see options on the Print dialog, click **Show Details**.



---

**NOTE:** Locations for the options can vary from one application to another.

---



4. From the pop-up menu, choose **Paper Type/Quality**.
5. From the Color pop-up menu, choose **Grayscale**, and then click **Print**.

# Improve print quality

You can print a diagnostics page to determine if cleaning or aligning the printheads is recommended to improve print quality.

From the HP Smart app, you can also improve the print quality. For more information about the app, see [Use the HP Smart app to print, scan, and troubleshoot on page 16](#).

## To print a print quality diagnostics page from the printer control panel

1. Load Letter or A4 unused plain white paper into the input tray.
2. Press  (the Color Copy button), and  (the Resume button) at the same time.

## To print a print quality diagnostics page from the HP printer software

1. Load Letter or A4 unused plain white paper into the input tray.
2. Complete the steps for your operating system:

### Windows:

- a. In the HP printer software (available from the **Start** menu), click **Print & Scan** at the top of the window.
- b. In the **Print** section, click **Maintain Your Printer** to access the Toolbox.
- c. In the Toolbox, click the **Device Services** tab, and then click **Print Quality Diagnostics Page**.

### Mac:

- a. In the **Applications** folder, open the **HP** folder, and then double-click **HP Utility**.
- b. In the **All Settings** section, click **Print Quality Diagnostics**, and then click **Print**.

3. Review the cyan, magenta, yellow, and black boxes along with the other content on the diagnostics page.



4. Clean the printheads, if the diagnostic page shows streaks or missing portions of the color and black boxes.  
For more information, see [Clean printheads on page 57](#).
5. Align the printheads, if straight lines appear jagged on printouts, or if the diagnostic page indicates aligning printheads might help.  
For more information, see [Align printheads on page 56](#).
6. If print quality problems persist after cleaning and aligning printheads, contact HP support.

## Align printheads

Aligning the printheads can improve print quality. If you notice misaligned colors or lines in your printouts or on the print quality diagnostics page, you should perform an alignment. For more information about the print quality diagnostics page, see [Improve print quality on page 54](#).

### To align the printheads (Windows)

1. Load Letter or A4 unused plain white paper into the input tray.
2. In the HP printer software (available from the **Start** menu), click **Print & Scan** at the top of the window.
3. In the **Print** section, click **Maintain Your Printer** to access the Toolbox.
4. In the Toolbox, click the **Device Services** tab, click the desired option, and then follow the onscreen instructions.

### To align the printheads (macOS)

1. Load Letter or A4 plain, white paper in the input tray.
2. Open HP Utility.  

---

 **NOTE:** HP Utility is located in the **HP** folder in the **Applications** folder.
3. Select your printer from the list of devices at the left of the window.
4. Click **Align**.
5. Click **Align** and follow the onscreen instructions.
6. Click **All Settings** to return to the **Information and Support** pane.

# Clean printheads

If your prints are streaked or have incorrect or missing colors, the printheads might need to be cleaned. You can also check the print quality diagnostics page to determine if cleaning is recommended. The cleaning process prints one page to attempt to clean the printheads. For more information about the print quality diagnostics page, see [Improve print quality on page 54](#).



---

**NOTE:** Clean the printheads only when necessary. Unnecessary cleaning wastes ink and shortens the life of the printheads.

---

## To clean the printheads (Windows)

1. Load Letter or A4 unused plain white paper into the input tray.
2. In the HP printer software (available from the **Start** menu), click **Print & Scan** at the top of the window.
3. In the **Print** section, click **Maintain Your Printer** to access the Toolbox.
4. In the Toolbox, click the **Device Services** tab, click the desired option, and then follow the onscreen instructions.

## To clean the printheads (macOS)



---

**CAUTION:** Clean the printheads only when necessary. Unnecessary cleaning wastes ink and shortens the life of the printheads.

---

1. Load Letter or A4 plain, white paper in the input tray.
2. Open HP Utility.



---

**NOTE:** HP Utility is located in the **HP** folder in the **Applications** folder.

---

3. Select your printer from the list of devices at the left of the window.
4. Click **Clean Printheads**.
5. Click **Clean**, and follow the onscreen instructions.



---

**CAUTION:** Clean the printhead only when necessary. Unnecessary cleaning wastes ink and shortens the life of the print head.



---

**NOTE:** If print quality still seems poor after you complete cleaning, try aligning the printhead. If print quality problems persist after cleaning and aligning, contact HP support.

---

6. Click **All Settings** to return to the **Information and Support** pane.

# Clean printer

You can run a cleaning routine from the printer software to prevent back of page smearing.

## To clean the printer from the printer software (Windows)

1. Load Letter or A4 unused plain white paper into the input tray.
2. In the HP printer software (available from the **Start** menu), click **Print & Scan** at the top of the window.
3. In the **Print** section, click **Maintain Your Printer** to access the Toolbox.
4. In the Toolbox, click the **Device Services** tab, click the desired option, and then follow the onscreen instructions.

# Tips for working with ink and printhead

## Printhead tips

Use the following tips to work with printheads:

- Use original HP printheads.
- To protect the printheads from drying out, always turn the printer off using the Power button, and wait until the Power button light goes out.
- Do not open or untape printheads until you are ready to install them. Leaving tape on the printheads reduces ink evaporation.
- Install both the black and color printheads correctly.

For more information, see [Printhead \(cartridge\) problem on page 76](#).

- After you have set up the printer, do not open the printhead latch unless instructed to do so.
- Align the printer for best print quality. See [Improve print quality on page 54](#) for more information.
- If you remove a printhead from the printer for any reason, try to replace it again as soon as possible. Outside of the printer, if unprotected, the printhead may begin to dry out.

## Ink tips

Use the following tips to work with ink:

- Make sure the ink tanks are not low on ink before printing.

For more information, see [Ink levels on page 48](#).

- Refill the ink tanks when they are low on ink. Printing with the ink tanks low on ink may cause damage to your printer.
- Do not tilt the printer.



**NOTE:** Original HP printheads and ink are designed and tested with HP printers and papers to help you easily produce great results, time after time.

HP cannot guarantee the quality or reliability of non-HP supplies. Product service or repairs required as a result of using a non-HP supply will not be covered under warranty.

## Move printer

To prevent damage to the printer or ink leakage, follow these instructions.

If you are moving the printer within your home or office, keep the printhead latch closed, and keep the printer level.

If you are moving the printer outside your home or office, see the instructions provided in box for moving printer, or visit [www.support.hp.com](http://www.support.hp.com).



---

## 5 Connect

- [Connect your printer to your computer with a USB cable \(non-network connection\)](#)

# Connect your printer to your computer with a USB cable (non-network connection)

The printer supports a rear USB 2.0 High Speed port for connection to a computer.

If the HP printer software has been installed, the printer will operate as a plug-and-play device. If the software has not been installed, follow the steps below to connect the printer with the USB cable.

## To connect the printer with a USB cable using the HP printer software

1. Enter [123.hp.com](http://123.hp.com) in a web browser on your computer to download and install the HP printer software. You can also use the HP printer software CD (if provided), or download the software from [www.support.hp.com](http://www.support.hp.com).



**NOTE:** Do not connect the USB cable to the printer until you are prompted to do so.

---

2. Follow the onscreen instructions. When you are prompted, connect the printer to the computer by selecting **USB** on the **Connection Options** screen.
3. Follow the onscreen instructions.

## To connect the printer with a USB cable using the HP Smart app

1. Connect the USB cable to the printer from your device.
2. Open the HP Smart app on your device. For information, see [Use the HP Smart app to print, scan, and troubleshoot on page 16](#).
3. On the Home screen of HP Smart, click or tap **+** (Plus icon), and then select your printer.

---

## 6 Solve a problem

This section contains the following topics:

- [Get help with HP online troubleshooting](#)
- [Get more help](#)
- [Printer control panel errors](#)
- [Get help from the HP Smart app](#)
- [Jams and paper-feed issues](#)
- [Printhead \(cartridge\) problem](#)
- [Printing issues](#)
- [Copy issues](#)
- [Scan issues](#)
- [Printer hardware issues](#)
- [Restore original factory defaults and settings](#)
- [Maintain the printer](#)
- [HP support](#)

## Get help with HP online troubleshooting

Use an HP online troubleshooting tool to solve your printer issues. Use the table below to identify your problem and click the appropriate link.



**NOTE:** The HP online troubleshooting wizards might not be available in all languages.

<b>Online troubleshooting tool</b>	<b>Use this tool to learn how to:</b>
<a href="#">Troubleshoot paper jam issues</a>	Clear jammed paper from the printer and resolve paper or paper feed issues.
<a href="#">Troubleshoot a print carriage jam</a>	Clear obstructions that are blocking the print carriage.
<a href="#">Troubleshoot issues with print job not printing</a>	Resolve issues with printer responsiveness, pages not printing, or “Unable to print” errors.
<a href="#">Troubleshoot copy and scan issues</a>	Determine why the printer will not copy or scan, or improve the quality of your copies or scans.
<a href="#">Troubleshoot print quality issues</a>	Improve the quality of your prints.
<a href="#">HP Print and Scan Doctor</a> (For Windows operating systems only)	Automatically diagnose and resolve printer issues.
<a href="#">HP Virtual Agent</a>	Chat with HP Virtual Agent to troubleshoot issues.

## Get more help



Solve printer issues with HP online troubleshooting tools

[Get help with HP online troubleshooting on page 64](#)



Diagnose and resolve printer issues

[HP Print and Scan Doctor](#)

(For Windows operating systems only)



Get printer documentation, troubleshooting information, software updates, and more

[www.support.hp.com](http://www.support.hp.com)



Use my device to print, scan, and manage my printer with the HP Smart app

• **Windows:** [www.hp.com/go/hpsmartwin-help](http://www.hp.com/go/hpsmartwin-help)



Scan with HP Scan software

[HP Scan software](#)



Order ink supplies

[HP Sure Supply](#)



Contact HP support

[Contact support website](#)



Register my product

[www.register.hp.com](http://www.register.hp.com)



View printer warranty options

[www.support.hp.com](http://www.support.hp.com)

## Printer control panel errors

If the Number Counter icon on the printer display is alternating between the letter E and a number, it indicates the printer is in an error state. The letter E and the number work as error codes. For example, if the Number Counter icon is alternating between the letter E and the number 4, it indicates that a paper jam has occurred.

For details on the errors and solutions, see [Control panel lights and display icons status on page 7](#).

## Get help from the HP Smart app

The HP Smart app provides alerts for printer issues (jams and other problems), links to help content, and options to contact support for additional assistance. For more information about the app, see [Use the HP Smart app to print, scan, and troubleshoot on page 16](#).

1. Open the HP Smart on your device.
2. On the Home screen of HP Smart, make sure your printer is selected.

---

 **TIP:** If a printer is already set up, you can select it from the Home screen of HP Smart by swiping left or right and selecting it.

To use a different printer, click or tap **+** (Plus icon) on the Home screen, and then select a different printer or add a new printer.

---

3. To view the printer status, click or tap the printer icon.

# Jams and paper-feed issues

## Clear a paper or print carriage jam

<a href="#">Solve paper jam issues.</a>	Use an HP online troubleshooting wizard Get step-by-step instructions for clearing paper jams and resolving issues with paper or the paper feed.
<a href="#">Resolve a print carriage jam.</a>	Use an HP online troubleshooting wizard If something is blocking the print carriage or it does not move easily, get step-by-step instructions.

 **NOTE:** The HP online troubleshooting wizards may not be available in all languages.

## Read general instructions in the Help for clearing jams

Paper jams can occur in several locations. For print carriage jams, remove any objects, including paper, that are blocking the print carriage in the printhead access area.

 **NOTE:** Do not use any tools or other devices to remove jammed objects. Always use caution when removing jammed objects from inside the printer.

### To clear a paper jam from the input tray

1. Press  (the Cancel button) to try to clear the jam automatically. If this does not work, complete the following steps to clear the jam manually.
2. Pull the paper gently out of the input tray.



3. Make sure there is no foreign object in the paper path, and then reload paper.

 **NOTE:** The input tray shield can prevent foreign debris from falling into the paper path and causing serious paper jams. Do not take down the input tray shield.

4. Press  (the Resume button) on the control panel to continue the current job.

### To clear a paper jam from the output tray

1. Press  (the Cancel button) to try to clear the jam automatically. If this does not work, complete the following steps to clear the jam manually.



2. Pull the paper gently out of the output tray.



3. Press  (the Resume button) on the control panel to continue the current job.

### To clear paper or other objects from the printhead (cartridge) access area

1. Press  (the Cancel button) to cancel printing. If this does not clear the error, complete the following steps to clear the jam manually.
2. Close the output tray extender, and then close the output tray.



3. Open the front door of the printer.

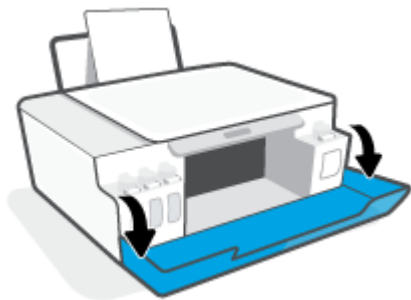

4. Open the printhead access door.

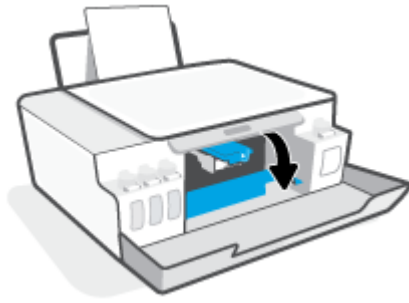

5. Make sure the print carriage is not obstructed. You might need to slide the carriage to the right side.



Remove any jammed paper or other objects blocking the carriage.

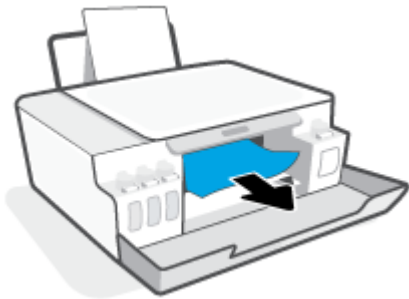

6. Make sure the printhead latch is properly closed.

**NOTICE:** After you have set up the printer, do not open the printhead latch unless instructed to do so.

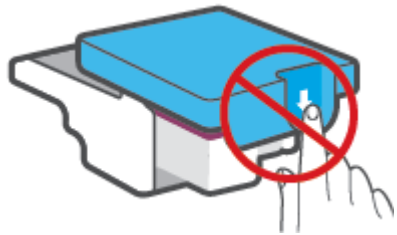



7. Close the front door of the printer.

8. Pull out the output tray and the tray extender.



### To clear a paper jam inside the printer

 **NOTE:** Follow the instructions in this section after you have tried other ways to clear paper jams. Before you begin, make sure the ink tank caps are firmly closed to prevent ink from leaking.

1. Press  (the Cancel button) to cancel printing. If this does not clear the error, complete the following steps to clear the jam manually.
2. Press  (the Power button) to turn off the printer.
3. Open the front door, and then open the printhead access door.

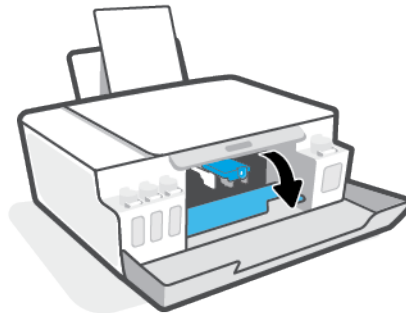
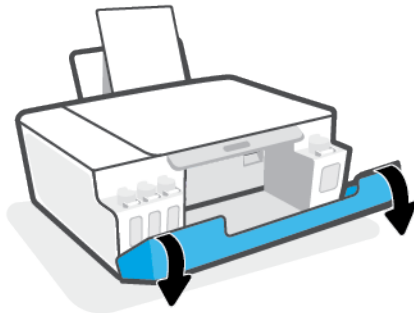

 **NOTE:** If the print carriage is not on the left side, manually move it to far left.

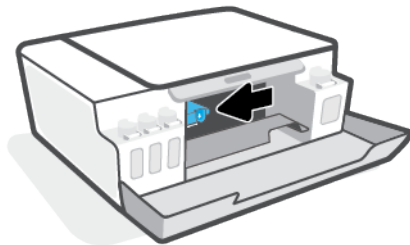

4. Press down on the side of the printhead latch to open.

 **NOTE:** After you have set up the printer, do not open the printhead latch unless instructed to do so.

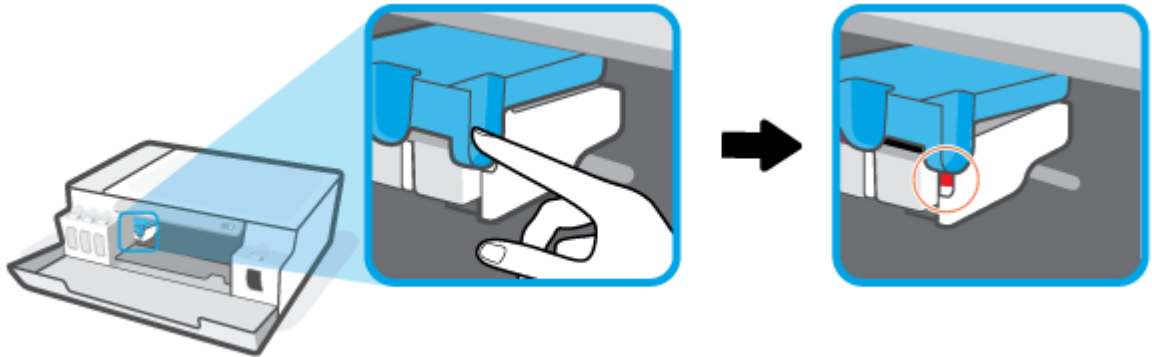

5. Close the doors.
6. Lift the front of the printer so that the printer is resting on its rear, to expose the bottom cleanout. Locate the cleanout door on the bottom of the printer, and then pull both tabs on the cleanout door to open it.

 **NOTE:** Do not keep the printer in a tilted position for too long to prevent ink from leaking.

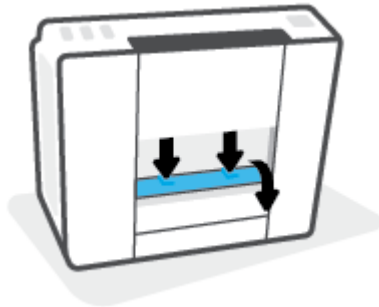

7. Remove the jammed paper.



8. Close the cleanout door. Gently push the door towards the printer until both latches snap into place.

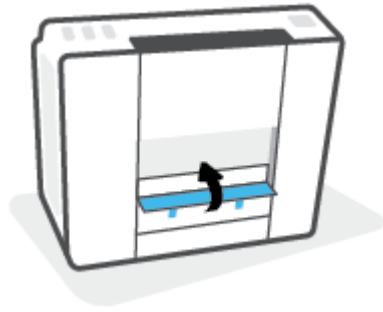

9. Turn the printer upright.
10. Open the front door, and then open the printhead access door.
11. Close the printhead latch, and then close the doors.

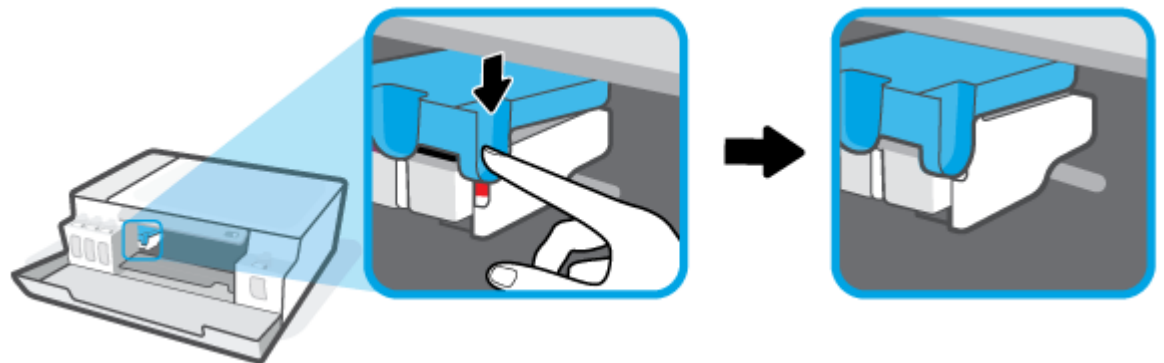

12. Connect the power cord, and then turn on the printer.

## Learn how to avoid paper jams

To help avoid paper jams, follow these guidelines.

- Do not overfill the input tray, but make sure that you have at least 5 pages loaded, for best results.
- Keep your printer free of dust and debris by removing paper and closing the input tray when not in use.
- Remove printed papers from the output tray frequently.
- Ensure that paper loaded in the input tray lays flat, and the edges are not bent or torn.
- Do not combine different paper types and paper sizes in the input tray; the entire stack of paper in the input tray must be the same size and type.

Use HP paper for optimum performance. See [Paper basics on page 13](#) for more information about HP paper.

- Adjust the paper-width guide in the input tray to fit snugly against all paper. Make sure the paper-width guide does not bend the paper in the input tray.

- Do not force paper too far down in the input tray.
- Do not add paper while the printer is printing. If the printer is about to run out of paper, wait until the out of paper message appears before adding paper.

## Solve paper-feed problems

What kind of problem are you having?

- **Paper is not picked up from the input tray**
  - Make sure paper is loaded in the input tray. For more information, see [Load media on page 21](#).
  - Adjust the paper-width guide in the input tray to fit snugly against all paper. Make sure the paper-width guide does not bend the paper in the input tray.
  - Make sure paper in the input tray is not curled. Uncurl paper by bending it in the opposite direction of the curl.
  - Clean the paper rollers.
- **Pages are skewing**
  - Make sure the paper is loaded in the far-right side of the input tray and the paper-width guide is fit against the left side of the paper.
  - Load paper into the printer only when it is not printing.
- **Multiple pages are being picked up**
  - Adjust the paper-width guide in the input tray to fit snugly against all paper. Make sure the paper-width guide does not bend the paper in the input tray.
  - Make sure the input tray is not overloaded with paper.
  - Make sure the pieces of the loaded paper are not sticking together.
  - Use HP paper for optimum performance and efficiency.
  - Clean the paper rollers.

### To clean the paper rollers manually

1. Gather the following materials:
  - A long, lint-free cotton swab
  - Distilled, filtered, or bottled water (tap water might damage the printer)
2. Press  (the Power button) to turn off the printer.
3. Disconnect the power cord from the rear of the printer.
4. Disconnect the USB cable, if it is not already disconnected.
5. Raise the input tray.
6. Lift and hold the input tray shield.



---

**NOTE:** Do not remove the input tray shield. The input tray shield prevents foreign debris from falling into the paper path and causing paper jams.

---

- 7.** Look down through the open input tray and find the gray paper pick rollers. You might need a flashlight to illuminate the area.
- 8.** Dampen a long cotton swab with bottled or distilled water, and then squeeze any excess water from the cloth.
- 9.** Press the swab against the rollers, and then rotate them upward with your fingers. Apply a moderate amount of pressure to remove dust or dirt buildup.
- 10.** Lower the input tray shield.
- 11.** Allow the rollers to dry for 10 or 15 minutes.
- 12.** Reconnect the power cord to the rear of the printer.
- 13.** Reconnect the USB cable to the printer if necessary.
- 14.** Press the Power button to turn on the printer.

## Printhead (cartridge) problem

If a message indicates a printhead problem, try the following in order:

1. Verify that the indicated printhead is correctly installed.
2. Clean the printhead contacts.
3. Contact HP support for assistance. Go to [www.support.hp.com](http://www.support.hp.com).

 **NOTE:** For more information on printhead problem, see [Printhead icons and Ink/Printhead light on page 7](#).

### To verify the printhead installed properly

**NOTICE:** The instructions here are only applicable in this section. After you have set up the printer, do not open the printhead latch unless instructed to do so.

1. Make sure the printer is turned on.
2. Close the output tray extender, and then close the output tray.



3. Remove and reinsert the printhead.
  - a. Open the front door of the printer.

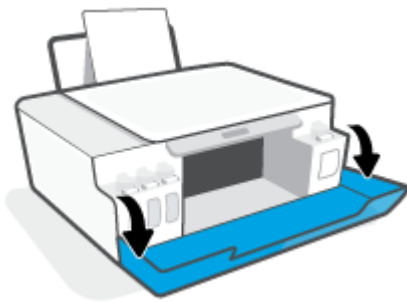



- b. Open the printhead access door.

---

**NOTICE:** After you have set up the printer, do not open the printhead latch unless instructed to do so.

---

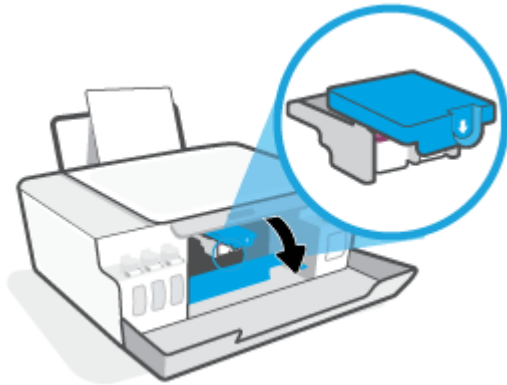

- c. Push down to open the printhead latch.

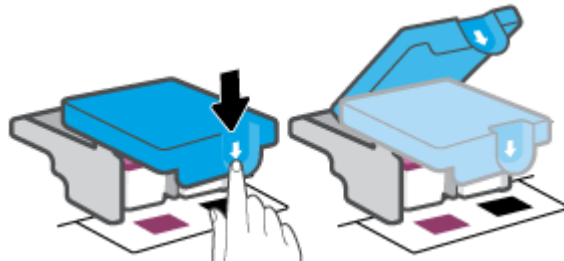

- d. Remove the printhead from the carriage.



- e. Check if there is a plug on top of the printhead or plastic tape on the printhead contacts. If there is, remove the plug from top of the printhead and the plastic tape from contacts.

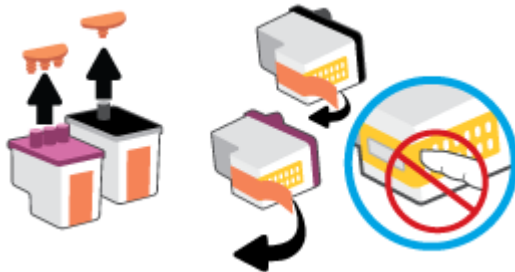

---

**NOTICE:** Do not touch the electrical contacts on the printhead.

---

- f. Slide the printhead into the slot until it clicks into place.

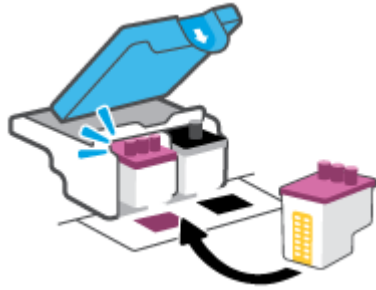

- g. Close the printhead latch. Make sure the printhead latch is properly closed to avoid problems such as carriage jams.

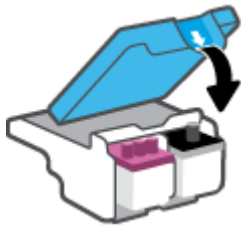

- h. Close the front door of the printer.

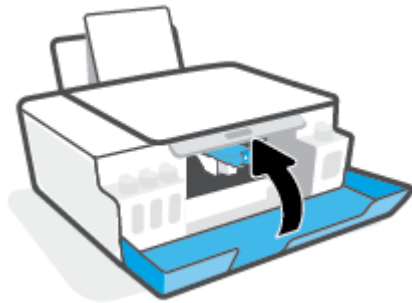

4. Pull out the output tray and the tray extender.



## To clean printhead contacts

 **NOTE:**

- Open the printhead latch and clean printhead contacts only when necessary; for example, if a printhead cannot be detected.

The instructions here are only applicable in this section. After you have set up the printer, do not open the printhead latch unless instructed to do so.

- The cleaning procedure should take only a few minutes. Make sure that the printheads are reinstalled in the printer as soon as possible. It is not recommended to leave the printheads outside of the printer longer than 30 minutes. This could result in damage to the printheads.

1. Make sure the printer is turned on.
2. Close the output tray extender, and then close the output tray.



3. Open the front door of the printer.

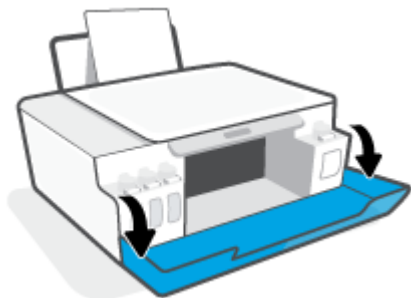

4. Open the printhead access door.

 **NOTE:** After you have set up the printer, do not open the printhead latch unless instructed to do so.

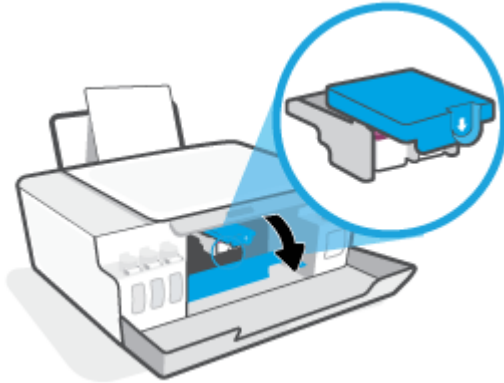

5. Push down to open the printhead latch.

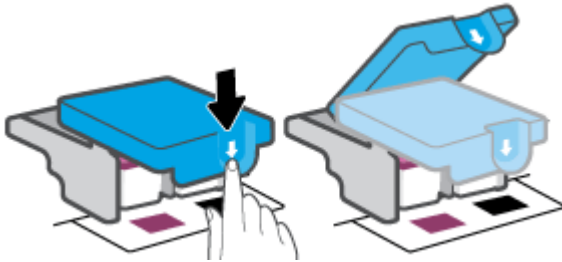

6. Remove the printhead indicated in the error message.



7. Clean the printhead contacts and printer contacts.

- a. Hold the printhead by its sides and locate the electrical contacts on the printhead.  
The electrical contacts are the small gold-colored dots on the printhead.



- b. Wipe only the contacts with a dry swab or lint-free cloth.

 **NOTE:** Be careful to wipe only the contacts, do not smear any ink or other debris on the contacts.

- c. On the inside of the printer, locate the contacts for the printhead.

The printer contacts are the set of gold-colored bumps positioned to meet the contacts on the printhead.

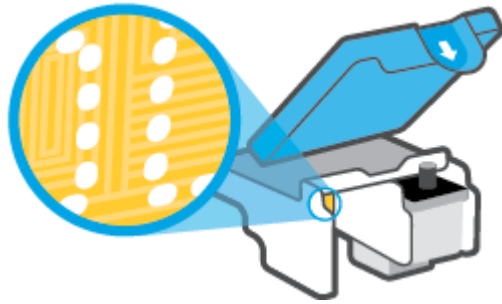

- d. Use a dry swab or lint-free cloth to wipe the contacts.

 **NOTE:** Be careful to wipe only the contacts, do not smear any ink or other debris on the contacts.

8. Reinstall the printhead.

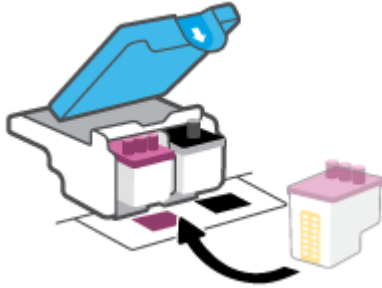

9. Close the printhead latch. Make sure the printhead latch is properly closed to avoid problems such as carriage jams.

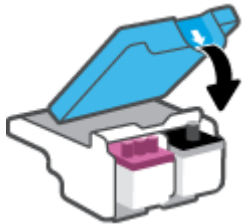

10. Close the front door of the printer.
11. Check if the error message has gone away. If you still receive the error message, turn the printer off, and then on.

# Printing issues

## Fix problems with page not printing (unable to print)

<a href="#">HP Print and Scan Doctor</a>	The HP Print and Scan Doctor is a utility that will try to diagnose and fix the issue automatically. <b>NOTE:</b> This utility is only available for the Windows operating system.
<a href="#">Troubleshoot problems with print jobs not printing.</a>	Use an HP online troubleshooting wizard Get step-by-step instructions if the printer is not responding or printing.



**NOTE:** The HP Print and Scan Doctor and the HP online troubleshooting wizards may not be available in all languages.

## Read general instructions in the Help for unable to print issues

### To resolve print issues (Windows)

Make sure that the printer is turned on and that there is paper in the input tray. If you are still unable to print, try the following in order:

1. Check for error messages from the printer software and resolve them by following the on-screen instructions.
2. If your computer is connected to the printer with a USB cable, disconnect and reconnect the USB cable.
3. Verify that the printer is not paused or offline.

#### To verify that the printer is not paused or offline

- a. Depending upon your operating system, do one of the following:
  - **Windows 10:** From the Windows **Start** menu, select **Windows System** from the app list, select **Control Panel**, and then click **View devices and printers** under **Hardware and Sound**.
  - **Windows 7:** From the Windows **Start** menu, click **Devices and Printers**.
- b. Either double-click or right-click the icon for your printer and select **See what's printing** to open the print queue.
- c. On the **Printer** menu, make sure there are no check marks next to **Pause Printing** or **Use Printer Offline**.
- d. If you made any changes, try to print again.
4. Verify that the printer is set as the default printer.

#### To verify that the printer is set as the default printer

- a. Depending upon your operating system, do one of the following:

- **Windows 10:** From the Windows **Start** menu, select **Windows System** from the app list, select **Control Panel**, and then click **View devices and printers** under **Hardware and Sound**.
  - **Windows 7:** From the Windows **Start** menu, click **Devices and Printers**.
- b. Make sure the correct printer is set as the default printer.
- The default printer has a check mark in a black or green circle next to it.
- c. If the wrong printer is set as the default printer, right-click the correct printer and select **Set as Default Printer**.
- d. Try using your printer again.
5. Restart the print spooler.

#### To restart the print spooler

- a. Depending upon your operating system, do one of the following:
- **Windows 10 :** From the Windows **Start** menu, click **Windows System**, and then click **Control Panel**.
  - **Windows 7:** From the Windows **Start** menu, click **Control Panel**.
- b. Click **System and Security**, and then click **Administrative Tools**.
- c. Double-click **Services**.
- d. Right-click the **Print Spooler**, and then click **Properties**.
- e. On the **General** tab, make sure **Automatic** is selected from the **Startup type** drop-down list.
- f. Under **Service status**, check the status.
- If the service is not running, click **Start**.
  - If the service is running, click **Stop**, and then click **Start** to restart the service.
- Then click **OK**.
6. Restart the computer.
7. Clear the print queue.

#### To clear the print queue

- a. Depending upon your operating system, do one of the following:
- **Windows 10:** From the Windows **Start** menu, click **Windows System**, and then click **Control Panel**. Under **Hardware and Sound**, click **View devices and printers**.
  - **Windows 7:** From the Windows **Start** menu, click **Devices and Printers**.
- b. Right-click the printer, and then select the option to see what is printing.
- c. On the **Printer** menu, click **Cancel all documents** or **Purge Print Document**, and then click **Yes** to confirm.

- d. If there are still documents in the queue, restart the computer and try printing again after the computer has restarted.
- e. Check the print queue again to make sure it is clear, and then try to print again.

### To resolve print issues (macOS)

1. Check for error messages and resolve.
2. Disconnect and reconnect the USB cable.
3. Verify that the product is not paused or offline.

#### To verify that the product is not paused or offline

- a. In **System Preferences**, click **Printers & Scanners**.
- b. Click the **Open Print Queue** button.
- c. Click a print job to select it.

Use the following buttons to manage the print job:

- **Delete:** Cancel the selected print job.
  - **Hold:** Pause the selected print job.
  - **Resume:** Continue a paused print job.
  - **Pause Printer:** Pause all print jobs in the print queue.
- d. If you made any changes, try to print again.
4. Restart the computer.

## Fix print quality issues

---

[Step-by-step instructions for resolving most print quality issues.](#)

Troubleshoot print quality issues online

---

### Read general instructions in the Help for resolving print quality issues



**NOTE:** To avoid print quality problems, always turn the printer off using the Power button, and wait until the Power button light goes out before you pull the plug or turn off a power strip. This allows the printer to move the printheads to a capped position, where they are protected from drying out.

---

To improve print quality, see [Improve print quality on page 54](#).



## Copy issues

For more information, see [Tips for successful scanning and copying on page 46](#).

---

<a href="#">Troubleshoot copy problems.</a>	Use an HP online troubleshooting wizard Get step-by-step instructions if the printer does not create a copy, or if your printouts are low quality.
---	---

---



**NOTE:** The HP online troubleshooting wizards may not be available in all languages.

---

## Scan issues

For more information, see [Tips for successful scanning and copying on page 46](#).

<a href="#">HP Print and Scan Doctor</a>	The HP Print and Scan Doctor is a utility that will try to diagnose and fix the issue automatically. <b>NOTE:</b> This utility is only available for the Windows operating system.
<a href="#">Solve scan problems</a>	Use an HP online troubleshooting wizard. Get step-by-step instructions if you cannot scan or if your scans are low quality.



**NOTE:** The HP Print and Scan Doctor and the HP online troubleshooting wizards might not be available in all languages.

# Printer hardware issues

## Close printer door

- Make sure the printhead access door and the front door are properly closed.

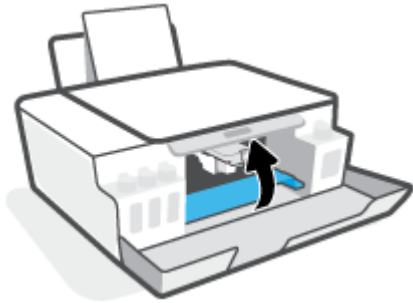

## The printer shuts down unexpectedly

- Check the power and power connections.
- Make sure the printer's power cord is connected firmly to a functioning power outlet.



**NOTE:** When Auto-Off is enabled, the printer will automatically turn off after 2 hours of inactivity to help reduce energy use. For more information, see [Auto-Off on page 19](#).





## Resolve printer failure

- Turn the printer off, then on. If that does not resolve the problem, contact HP.

## Restore original factory defaults and settings

- If you have made changes to the printer, you can restore the printer to the original factory settings.

### To restore printer factory defaults from the printer control panel

- While holding  (the Power button), press and hold  (the Black Copy button) and  (the Resume button) at the same time, until  (spinning wheel) appears on the display.

## Maintain the printer

- [Clean the scanner glass](#)
- [Clean the exterior](#)

### Clean the scanner glass

Dust or dirt on the scanner glass, scanner lid backing, or scanner frame can slow down performance, degrade the quality of scans, and affect the accuracy of special features such as fitting copies to a certain page size.

#### To clean the scanner glass

---

**⚠ WARNING!** Before cleaning the printer, turn the printer off by pressing  (the Power button), and unplug the power cord from the electrical socket.

---

1. Lift the scanner lid.



2. Clean the scanner glass and lid backing by using a soft, lint-free cloth that has been sprayed with a mild glass cleaner.



---

**⚠ CAUTION:** Use only glass cleaner to clean the scanner glass. Avoid cleaners that contain abrasives, acetone, benzene, and carbon tetrachloride, all of which can damage the scanner glass. Avoid isopropyl alcohol because it can leave streaks on the scanner glass.



**CAUTION:** Do not spray the glass cleaner directly on the scanner glass. If too much glass cleaner is applied, the cleaner could leak under the scanner glass and damage the scanner.

---

3. Close the scanner lid, and turn on the printer.

## Clean the exterior

---

 **WARNING!** Before cleaning the printer, turn the printer off by pressing the power button  (the Power button), and unplugging the power cord from the electrical socket.

---

Use a soft, damp, lint-free cloth to wipe dust, smudges, and stains off of the case. Keep fluids away from the interior of the printer, as well as from the printer control panel.

## HP support

For the latest product updates and support information, visit [www.support.hp.com](http://www.support.hp.com). HP online support provides a variety of options for help with your printer:



**Drivers & downloads:** Download software drivers and updates, as well as product manuals and documentation that came in the box with your printer.



**HP support forums:** Visit HP Support Forums for answers to common questions and issues. You can view questions posted by other HP customers, or sign in and post your own questions and comments.



**Troubleshooting:** Use HP online tools to detect your printer and find recommended solutions.

---



**NOTE:** You can also use the HP Smart app to check printer errors and get troubleshooting assistance. For information about this app, see [Use the HP Smart app to print, scan, and troubleshoot on page 16](#).

---

## Contact HP

If you need help from an HP technical support representative to solve a problem, visit the [Contact Support website](#). The following contact options are available at no cost for in-warranty customers (HP agent-assisted support for out-of-warranty customers may require a fee):



Chat with an HP support agent online.



Call an HP support agent.

---

When contacting HP support, be prepared to provide the following information:

- Product name (located on the printer)
- Product number (located inside the front door)



- Serial number (located on the back or bottom of the printer)

## Register printer

By taking just a few quick minutes to register, you can enjoy quicker service, more efficient support, and product support alerts. If you did not register your printer while installing the software, you can register now at <http://www.register.hp.com>.

## Additional warranty options

Extended service plans are available for the printer at additional costs. Go to [www.support.hp.com](http://www.support.hp.com), select your country/region and language, then explore the extended warranty options available for your printer.



---

# A Technical information

The information contained herein is subject to change without notice.

This section contains the following topics:

- [Specifications](#)
- [Regulatory notices](#)
- [Environmental product stewardship program](#)

# Specifications

For more information, visit [www.support.hp.com](http://www.support.hp.com) .

## System requirements

- For information about future operating system releases and support, visit [www.support.hp.com](http://www.support.hp.com) .

## Environmental specifications

- Recommended operating temperature range: 15°C to 30°C (59°F to 86°F)
- Operating temperature range: 5°C to 40°C (41°F to 104°F)
- Recommended Operating Humidity range: 20% to 80% RH non-condensing
- Operating Humidity range: 15% to 80% RH non-condensing
- Nonoperating (Storage) temperature range: -40°C to 60°C (-40°F to 140°F)
- In the presence of high electromagnetic fields, it is possible the output from the printer may be slightly distorted
- HP recommends using a USB cable less than or equal to 3 m (10 feet) in length to minimize injected noise due to potential high electromagnetic fields

## Input tray capacity

- Plain paper sheets (75 g/m<sup>2</sup> [20lb]): Up to 100
- Envelopes: Up to 10
- Index cards: Up to 30
- Photo paper sheets: Up to 30

## Output tray capacity

- Plain paper sheets (75 g/m<sup>2</sup> [20lb]): Up to 30
- Envelopes: Up to 10
- Index cards: Up to 30
- Photo paper sheets: Up to 30

## Paper weights

- Plain Paper: 60 to 90 g/m<sup>2</sup> (16 to 24 lb)
- Envelopes: 75 to 90 g/m<sup>2</sup> (20 to 24 lb)
- Cards: Up to 200 g/m<sup>2</sup> (110-lb index maximum)
- Photo Paper: Up to 300 g/m<sup>2</sup> (80 lb)

### **Print specifications**

- Print speeds vary according to the complexity of the document
- Method: drop-on-demand thermal inkjet
- Language: PCL3 GUI

### **Copy specifications**

- Resolution: up to 600 dpi
- Digital image processing
- Copy speeds vary according to the complexity of the document and model

### **Scan specifications**

- Resolution: up to 1200 x 1200 ppi optical  
For more information about ppi resolution, see the scanner software.
- Color: 24-bit color, 8-bit grayscale (256 levels of gray)
- Maximum scan size from glass: 21.6 x 29.7 cm (8.5 x 11.7 inches)

### **Print resolution**

- For supported print resolutions, visit [www.support.hp.com](http://www.support.hp.com).

### **Acoustic information**

- If you have Internet access, you can access acoustic information from the [HP website](#).

## Regulatory notices

The printer meets product requirements from regulatory agencies in your country/region.

This section contains the following topics:

- [Regulatory model number](#)
- [Power cord instructions](#)
- [Visual display workplaces statement for Germany](#)
- [Noise emission statement for Germany](#)
- [European Union Regulatory Notice](#)
- [Declaration of conformity](#)

### Regulatory model number

For regulatory identification purposes, your product is assigned with a Regulatory Model Number. The regulatory model number should not be confused with the marketing names or product numbers.

### Power cord instructions

Make sure your power source is adequate for the product voltage rating. The voltage rating is on the product. The product uses either 100–240 Vac or 200–240 Vac and 50/60 Hz.

---

**⚠ CAUTION:** To prevent damage to the product, use only the power cord that is provided with the product.

---

### Visual display workplaces statement for Germany

#### **GS-Erklärung (Deutschland)**

Das Gerät ist nicht für die Benutzung im unmittelbaren Gesichtsfeld am Bildschirmarbeitsplatz vorgesehen. Um störende Reflexionen am Bildschirmarbeitsplatz zu vermeiden, darf dieses Produkt nicht im unmittelbaren Gesichtsfeld platziert werden.

### Noise emission statement for Germany

Geräuschemission

LpA < 70 dB am Arbeitsplatz im Normalbetrieb nach DIN 45635 T. 19

### European Union Regulatory Notice



Products bearing the CE marking comply to applicable EU Directives and related European Harmonised Standards. The full Declaration of Conformity can be found at the following website:

[www.hp.eu/certificates](http://www.hp.eu/certificates) (Search with the product model name or its Regulatory Model Number (RMN), which may be found on the regulatory label.)

The point of contact for regulatory matters is HP Deutschland GmbH, HQ-TRE, 71025, Boeblingen, Germany.

## **Declaration of conformity**

Declaration of conformity can be found at [www.hp.eu/certificates](http://www.hp.eu/certificates).

## Environmental product stewardship program

HP is committed to providing quality products in an environmentally sound manner. Design for recycling has been incorporated into this product. The number of materials has been kept to a minimum while ensuring proper functionality and reliability. Dissimilar materials have been designed to separate easily. Fasteners and other connections are easy to locate, access, and remove using common tools. High priority parts have been designed to access quickly for efficient disassembly and repair.

For more information, visit HP's Commitment to the Environment Web site at:

[www.hp.com/sustainableimpact](http://www.hp.com/sustainableimpact).

- [Eco-Tips](#)
- [European Union Commission Regulation 1275/2008](#)
- [Paper](#)
- [Plastics](#)
- [Safety data sheets](#)
- [Recycling program](#)
- [HP inkjet supplies recycling program](#)
- [Power consumption](#)
- [Disposal of waste equipment by users](#)
- [Waste disposal for Brazil](#)
- [Chemical substances](#)
- [The Table of Hazardous Substances/Elements and their Content \(China\)](#)
- [Declaration of the Presence Condition of the Restricted Substances Marking \(Taiwan\)](#)
- [Restriction of hazardous substance \(India\)](#)
- [Regulation on the Control of Waste Electrical and Electronic Equipment \(Turkey\)](#)
- [EPEAT](#)
- [SEPA Ecolabel User Information \(China\)](#)
- [China Energy Label for Printer, Fax and Copier](#)

### Eco-Tips

HP is committed to helping customers reduce their environmental footprint. Please visit the HP Eco Solutions website for more information on HP's environmental initiatives.

[www.hp.com/sustainableimpact](http://www.hp.com/sustainableimpact)

### European Union Commission Regulation 1275/2008

For product power data, including the power consumption of the product in networked standby if all wired network ports are connected and all wireless network ports are activated, please refer to section P15

'Additional Information' of the product IT ECO Declaration at [www.hp.com/hpinfo/globalcitizenship/environment/productdata/itecodesktop-pc.html](http://www.hp.com/hpinfo/globalcitizenship/environment/productdata/itecodesktop-pc.html).

## Paper

This product is suited for the use of recycled paper according to DIN 19309 and EN 12281:2002.

## Plastics

Plastic parts over 25 grams are marked according to international standards that enhance the ability to identify plastics for recycling purposes at the end of product life.

## Safety data sheets

Safety Data Sheets, product safety and environmental information are available at [www.hp.com/go/ecodata](http://www.hp.com/go/ecodata) or on request.

## Recycling program

HP offers an increasing number of product return and recycling programs in many countries/regions, and partners with some of the largest electronic recycling centers throughout the world. HP conserves resources by reselling some of its most popular products. For more information regarding recycling of HP products, please visit:

[www.hp.com/recycle](http://www.hp.com/recycle)

## HP inkjet supplies recycling program

HP is committed to protecting the environment. The HP Inkjet Supplies Recycling Program is available in many countries/regions, and lets you recycle used print cartridges and ink cartridges free of charge. For more information, go to the following website:

[www.hp.com/hpinfo/globalcitizenship/environment/recycle/](http://www.hp.com/hpinfo/globalcitizenship/environment/recycle/)

## Power consumption

HP printing and imaging equipment marked with the ENERGY STAR® logo is certified by the U.S. Environmental Protection Agency. The following mark will appear on ENERGY STAR certified imaging products:



Additional ENERGY STAR certified imaging product model information is listed at: [www.hp.com/go/energystar](http://www.hp.com/go/energystar)

## Disposal of waste equipment by users



This symbol means do not dispose of your product with your other household waste. Instead, you should protect human health and the environment by handing over your waste equipment to a designated collection point for the recycling of waste electrical and electronic equipment. For more information, please contact your household waste disposal service, or go to <http://www.hp.com/recycle>.

## Waste disposal for Brazil



Não descarte o produto eletrônico em lixo comum

Este produto eletrônico e seus componentes não devem ser descartados no lixo comum, pois embora estejam em conformidade com padrões mundiais de restrição a substâncias nocivas, podem conter, ainda que em quantidades mínimas, substâncias impactantes ao meio ambiente. Ao final da vida útil deste produto, o usuário deverá entregá-lo à HP. A não observância dessa orientação sujeitará o infrator às sanções previstas em lei.

Após o uso, as pilhas e/ou baterias dos produtos HP deverão ser entregues ao estabelecimento comercial ou rede de assistência técnica autorizada pela HP.

Para maiores informações, inclusive sobre os pontos de recebimento, acesse:

[www.hp.com.br/reciclar](http://www.hp.com.br/reciclar)

## Chemical substances

HP is committed to providing our customers with information about the chemical substances in our products as needed to comply with legal requirements such as REACH (*Regulation EC No 1907/2006 of the European Parliament and the Council*). A chemical information report for this product can be found at: [www.hp.com/go/reach](http://www.hp.com/go/reach).

## The Table of Hazardous Substances/Elements and their Content (China)

产品中有害物质或元素的名称及含量

根据中国《电器电子产品有害物质限制使用管理办法》



部件名称	有害物质					
	铅 (Pb)	汞 (Hg)	镉 (Cd)	六价铬 (Cr(VI))	多溴联苯 (PBB)	多溴二苯醚 (PBDE)
外壳和托盘	0	0	0	0	0	0
电线	0	0	0	0	0	0
印刷电路板	X	0	0	0	0	0
打印系统	X	0	0	0	0	0
显示器	X	0	0	0	0	0



部件名称	有害物质					
	铅 (Pb)	汞 (Hg)	镉 (Cd)	六价铬 (Cr(VI))	多溴联苯 (PBB)	多溴二苯醚 (PBDE)
喷墨打印机墨盒	0	0	0	0	0	0
驱动光盘	X	0	0	0	0	0
扫描仪	X	0	0	0	0	0
网络配件	X	0	0	0	0	0
电池板	X	0	0	0	0	0
自动双面打印系统	0	0	0	0	0	0
外部电源	X	0	0	0	0	0

本表格依据 SJ/T 11364 的规定编制。

0：表示该有害物质在该部件所有均质材料中的含量均在 GB/T 26572 规定的限量要求以下。

X：表示该有害物质至少在该部件的某一均质材料中的含量超出 GB/T 26572 规定的限量要求。

此表中所有名称中含“X”的部件均符合欧盟 RoHS 立法。

注：环保使用期限的参考标识取决于产品正常工作的温度和湿度等条件。

## Declaration of the Presence Condition of the Restricted Substances Marking (Taiwan)

台灣 限用物質含有情況標示聲明書

### Taiwan Declaration of the Presence Condition of the Restricted Substances Marking

單元 Unit	限用物質及其化學符號 Restricted substances and its chemical symbols					
	鉛 (Pb)	汞 (Hg)	鎘 (Cd)	六價鉻 (Cr <sup>+6</sup> )	多溴聯苯 (PBB)	多溴二苯醚 (PBDE)
列印引擎 Print engine	—	○	○	○	○	○
外殼和紙匣 External casing and trays	○	○	○	○	○	○
電源供應器 Power supply	—	○	○	○	○	○
電線 Cables	○	○	○	○	○	○
印刷電路板 Print printed circuit board	—	○	○	○	○	○
控制面板 Control panel	—	○	○	○	○	○
墨水匣 Cartridge	○	○	○	○	○	○
掃描器組件 Scanner assembly	—	○	○	○	○	○

備考 1. “超出 0.1 wt %” 及 “超出 0.01 wt %” 係指限用物質之百分比含量超出百分比含量基準值。

Note 1: “Exceeding 0.1 wt %” and “exceeding 0.01 wt %” indicate that the percentage content of the restricted substance exceeds the reference percentage value of presence condition.

備考 2. “○” 係指該項限用物質之百分比含量未超出百分比含量基準值。

Note 2: “○” indicates that the percentage content of the restricted substance does not exceed the percentage of reference value of presence.

備考 3. “—” 係指該項限用物質為排除項目。

Note 3: “—” indicates that the restricted substance corresponds to the exemption.

若要存取產品的最新使用指南或手冊，請前往 [www.support.hp.com](http://www.support.hp.com)。選取搜尋您的產品，然後依照畫面上的指示繼續執行。

To access the latest user guides or manuals for your product, go to [www.support.hp.com](http://www.support.hp.com). Select **Find your product**, and then follow the onscreen instructions.

## Restriction of hazardous substance (India)

This product, as well as its related consumables and spares, complies with the reduction in hazardous substances provisions of the "India E-waste Rule 2016." It does not contain lead, mercury, hexavalent chromium, polybrominated biphenyls or polybrominated diphenyl ethers in concentrations exceeding 0.1 weight % and 0.01 weight % for cadmium, except where allowed pursuant to the exemptions set in Schedule 2 of the Rule.

## Regulation on the Control of Waste Electrical and Electronic Equipment (Turkey)

Türkiye Cumhuriyeti: AEEE Yönetmeliğine uygundur

## EPEAT

Most HP products are designed to meet EPEAT. EPEAT is a comprehensive environmental rating that helps identify greener electronics equipment. For more information on EPEAT go to [www.epeat.net](http://www.epeat.net). For information on HP's EPEAT registered products go to [www.hp.com/hpinfo/globalcitizenship/environment/pdf/epeat\\_printers.pdf](http://www.hp.com/hpinfo/globalcitizenship/environment/pdf/epeat_printers.pdf).

## SEPA Ecolabel User Information (China)

### 中国环境标识认证产品用户说明

噪声大于 63.0 dB(A) 的办公设备不宜放置于办公室内，请在独立的隔离区域使用。

如需长时间使用本产品或打印大量文件，请确保在通风良好的房间内使用。

如您需要确认本产品处于零能耗状态，请按下电源关闭按钮，并将插头从电源插座断开。

您可以使用再生纸，以减少资源耗费。

## China Energy Label for Printer, Fax and Copier

### 复印机、打印机和传真机能源效率标识实施规则

依据“复印机、打印机和传真机能源效率标识实施规则”，该打印机具有中国能效标识。标识上显示的能效等级和操作模式值根据“复印机、打印机和传真机能效限定值及能效等级”标准（“GB 21521”）来确定和计算。

#### 1. 能效等级

产品能效等级分 3 级，其中 1 级能效最高。能效限定值根据产品类型和打印速度由标准确定。能效等级则根据基本功耗水平以及网络接口和内存等附加组件和功能的功率因子之和来计算。

#### 2. 能效信息

## 喷墨打印机

- 操作模式功率

睡眠状态的能耗按照 GB 21521 的标准来衡量和计算。该数据以瓦特 (W) 表示。

- 待机功率

待机状态是产品连接到电网电源上功率最低的状态。该状态可以延续无限长时间，且使用者无法改变此状态下产品的功率。对于“成像设备”产品，“待机”状态通常相当于“关闭”状态，但也可能相当于“准备”状态或者“睡眠”状态。该数据以瓦特 (W) 表示。

- 睡眠状态预设延迟时间

出厂前由制造商设置的时间决定了该产品在完成主功能后进入低耗模式（例如睡眠、自动关机）的时间。该数据以分钟表示。

- 附加功能功率因子之和

网络接口和内存等附加功能的功率因子之和。该数据以瓦特 (W) 表示。

标识上显示的能耗数据是根据典型配置测量得出的数据，此类配置包含登记备案的打印机依据复印机、打印机和传真机能源效率标识实施规则所选的所有配置。因此，该特定产品型号的实际能耗可能与标识上显示的数据有所不同。

要了解规范的更多详情，请参考最新版的 GB 21521 标准。

---

# Index

## B

buttons, control panel 5

## C

clean

- exterior 90
- scanner glass 89

control panel

- buttons 5
- features 5
- status icons 5

copy

- specifications 95

customer support

- warranty 92

## E

environment

- Environmental product stewardship program 98
- environmental specifications 94

## G

glass, scanner

- clean 89

## J

jams

- clear 68

## M

maintenance

- clean 90

multi-feeds, troubleshoot 74

## O

operating systems supported 94

## P

paper

- clear jams 68
- HP, order 14
- skewed pages 74
- troubleshoot feeding 74

paper-feed problems, troubleshoot 74

power

- troubleshoot 87

print

- specifications 95
- troubleshoot 87

## R

recycle

- ink cartridges 99

regulatory notices 96

- regulatory model identification number 96

## S

scan

- scan specifications 95

scanner glass

- clean 89

skew, troubleshoot

- print 74

specifications

- system requirements 94

status icons 5

system requirements 94

## T

technical information

- copy specifications 95
- environmental specifications 94
- print specifications 95
- scan specifications 95

trays

- clear paper jams 68
- troubleshoot feeding 74

troubleshoot

- multiple pages are picked 74
- paper not picked up from tray 74
- paper-feed problems 74
- power 87
- print 87
- skewed pages 74

## W

warranty 92

Windows

- system requirements 94