

PHILIPS

STH3000, STH3010
STH3020



EN User manual

ID Buku Petunjuk Pengguna

KO 사용 설명서







MS Manual pengguna

TH คู่มือผู้ใช้

VI Hướng dẫn sử dụng

SC 用户手册

TC 使用手冊

| | | | |
|---|---|---|----|
|  | 3 |  | 10 |
|  | 4 |  | 11 |
|  | 5 |  | 12 |
|  | 8 |  | 27 |
|  | 9 | | |

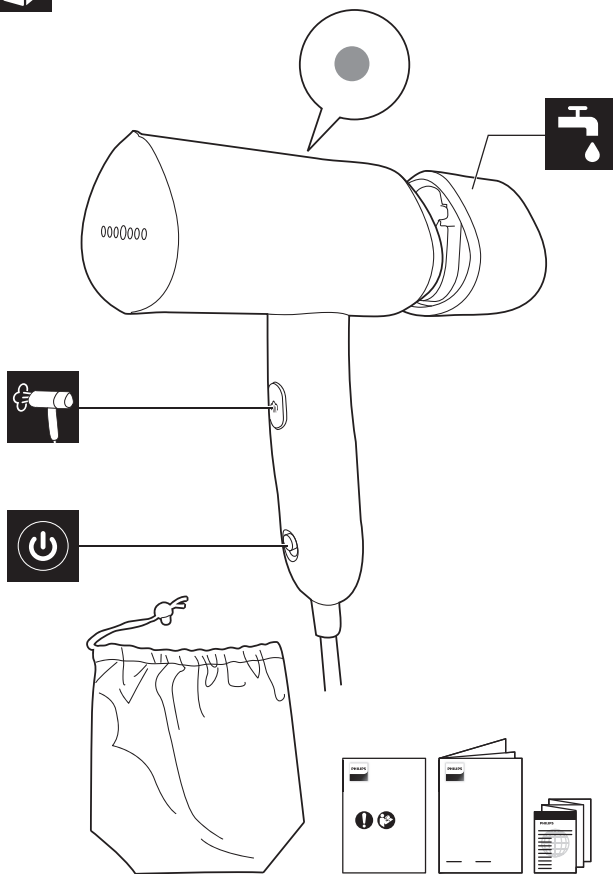

STH3010, STH3020

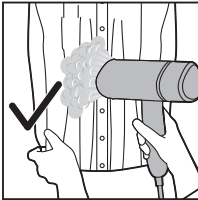
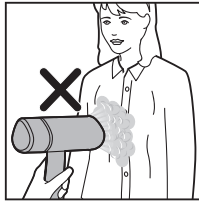
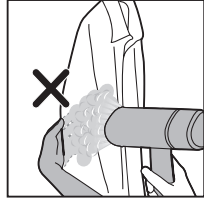
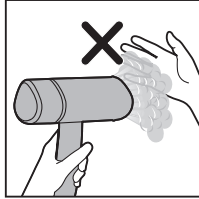
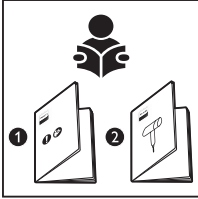

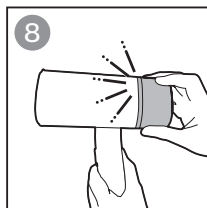
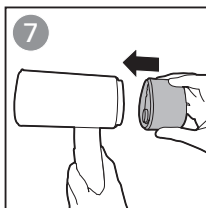
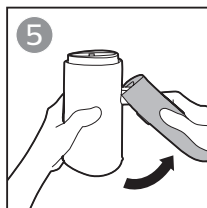
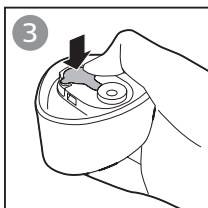
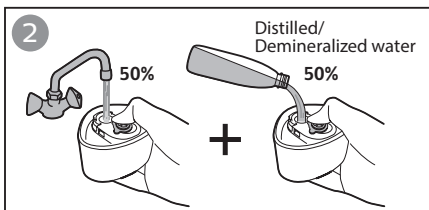
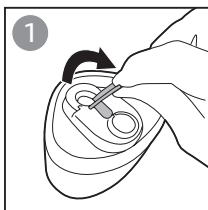
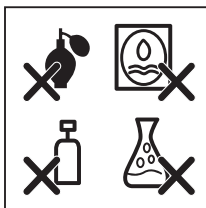
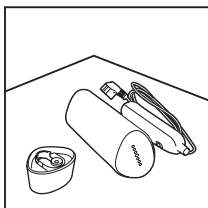

EN The appliance is suitable to be used with tap water. However, if you live in an area with hard water, we recommend that you mix an equal amount of tap water with distilled or demineralized water. This will prevent fast scale build up and prolong the lifetime of the appliance.

Warning: Do not add perfume, water from tumble dryer, vinegar, magnetically treated water (e.g., Aqua +), starch, descaling agents, ironing aids, chemically descaled water or other chemicals as they may cause water spitting, brown staining or damage to your appliance.

ID Alat ini bisa menggunakan air keran. Namun jika Anda tinggal di daerah dengan kesadahan air yang tinggi, kami sarankan untuk mencampurkan air keran dengan air suling dengan perbandingan yang sama. Hal ini akan mencegah terbentuknya kerak dengan cepat dan memperpanjang masa pakai alat.

Perhatian: Jangan tambahkan parfum, air dari pengering pakaian, cuka, air magnetik (misalnya Aqua +), kanji, zat pembersih kerak, pelicin pakaian, air bebas kerak dengan proses kimia, atau bahan kimia lain karena dapat menyebabkan air menyembur, noda cokelat, atau kerusakan pada alat.

KO 이 제품은 수도물로 사용하는 것이 적합합니다. 그러나 경수 지역에 거주하는 경우, 수도물과 같은 양의 증류수 또는 탈염수를 혼합하는 것이 좋습니다. 이로써 석회질이 빨리 쌓이지 않고, 제품의 수명이 연장됩니다.

경고: 다리미에 향수, 세탁 건조기의 물, 식초, 자기처리수(예: Aqua+), 녹말, 석회질 제거제, 다림질 보조제, 이물질 제거용 화학약품 및 기타 화학 약품을 넣지 마십시오. 물이 튀거나 갈색 얼룩이 생기거나 다리미가 손상될 수 있습니다.

MS Perkakas sesuai untuk digunakan dengan air paip. Walau bagaimanapun, jika anda tinggal di kawasan dengan air liat, kami menasihatkan agar anda mencampurkan air paip dengan air suling atau air tanpa mineral dalam jumlah yang sama. Langkah ini akan menghalang pembentukan karat yang cepat dan memanjangkan hayat perkakas anda.

Amaran: Jangan tambahkan minyak wangi, air mesin pengering, cuka, air yang dirawat secara magnet (misalnya, Aqua +), kanji, agen

penyahkerakan, bahan bantu penyeterikaan, air yang dinyahkerak secara kimia atau bahan kimia lain kerana ini boleh menyebabkan air berdetus, kesan kotoran perang atau kerosakan pada perkakas anda.

TH เครื่องเหมาะสำหรับใช้งานกับน้ำประปา อย่างไรก็ตาม หากคุณอาศัยอยู่ในพื้นที่ที่น้ำกระด้างมาก เราขอแนะนำให้คุณผสมน้ำประปาในปริมาณที่เท่ากับน้ำกลั่นหรือน้ำปราศจากแร่ธาตุ ซึ่งจะช่วยป้องกันไม่ให้เกิดตะกอนสะสมอย่างรวดเร็วและยืดอายุการใช้งานของเครื่อง

คำเตือน: อย่าใส่น้ำหอม น้ำจากเครื่องอบผ้า น้ำส้มสายชู น้ำที่เป็นผลจากพลังงานแม่เหล็ก (เช่น Aqua+) แป้ง น้ำยาขจัดคราบตะกอน น้ำยารีดผ้าเรียบ ผลิตภัณฑ์สำหรับการรีดผ้าหรือสารเคมีอื่นๆ เนื่องจากอาจทำให้น้ำกระเด็น เกิดคราบสีน้ำตาล หรือทำให้เครื่องเสียหายได้

VI Thiết bị thích hợp để sử dụng với nước máy. Tuy nhiên, nếu bạn sống ở khu vực có nước cứng, bạn nên hòa một lượng bằng nhau nước máy và nước cất hoặc nước đã khử khoáng. Việc này sẽ ngăn tích tụ cặn nhanh và giúp kéo dài tuổi thọ của thiết bị.

Cảnh báo: Không thêm nước hoa, nước từ máy sấy đảo, giảm, nước đã khử từ tính (ví dụ: Aqua+), hồ vôi, chất làm sạch cặn, chất phụ trợ ủi, nước đã được tẩy sạch bằng hóa chất hoặc các hóa chất khác do các chất này có thể gây tình trạng phun nước, ô vàng hoặc làm hỏng thiết bị của bạn.

SC 本产品可使用自来水。但如果您居住的区域水质较硬，我们建议您将等量的自来水与蒸馏水或软化水混合使用。这样可以防止水垢快速积聚，从而延长产品的使用寿命。

警告: 请勿加入香水、转筒式干燥机中的水、醋、磁处理水（例如 Aqua+）、淀粉、除垢剂、熨衣剂、化学除垢水或其他化学物质，这些会造成喷水、留下棕色污渍或损坏产品。

TC 本產品適合搭配自來水使用。不過，如果您居住地區的水質偏硬，建議您將等量的自來水與蒸餾水或軟化水混合。如此可避免快速累積水垢，並延長產品的使用壽命。

警告: 請勿添加香水、滾筒式烘乾機的水、醋、磁化水(例如 Aqua+)、燙衣漿、除垢劑、熨燙添加劑、經化學除垢的水或其他化學物質，否則可能造成水噴濺溢漏、產生棕色汙漬或損壞產品。

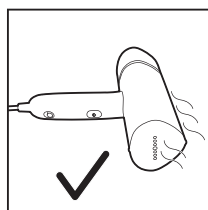
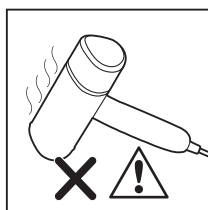
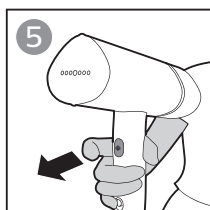
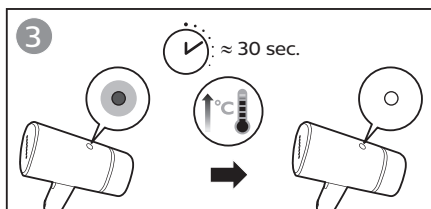
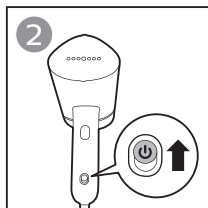
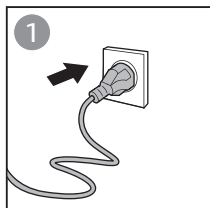

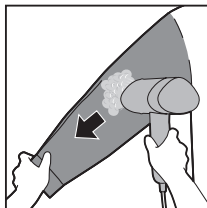
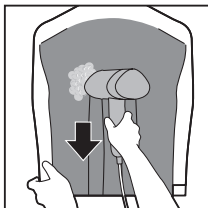
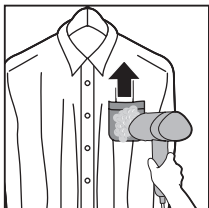
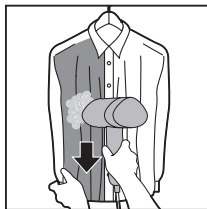
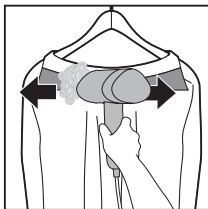
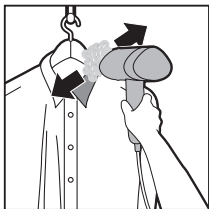
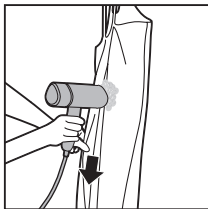
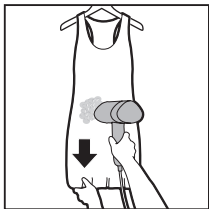

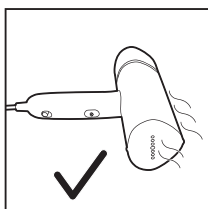
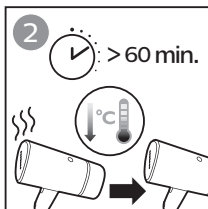
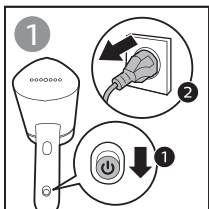

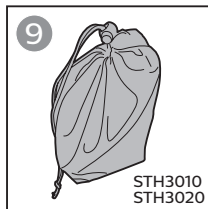
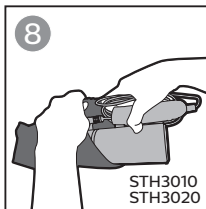
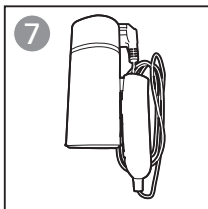
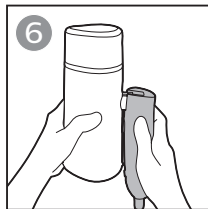
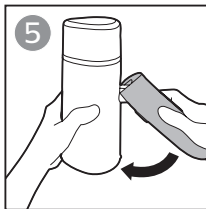
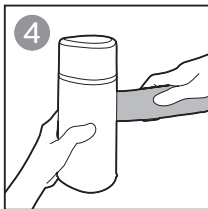
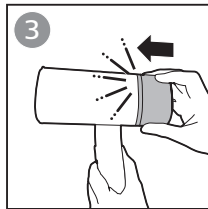
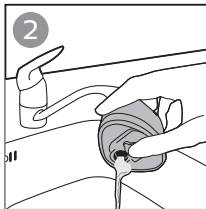
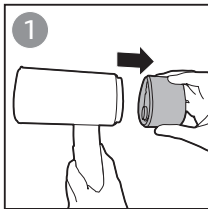



EN

| Problem | Possible cause | Solution |
|---|--|--|
| The appliance does not heat up. | The appliance is not plugged in properly or not switched on. | Check if the mains plug is inserted properly and its wall socket is working. Check if the appliance is switched on. |
| The appliance does not produce any steam. | The appliance is not plugged in properly or not switched on. | Check if the mains plug is inserted properly and its wall socket is working. Check if the appliance is switched on. |
| | The appliance has not heated up sufficiently. | Let the appliance heat up ≈ 30 seconds ("steam-ready" light will be on). When the appliance is ready for use, the light turns off. |
| | You have not pressed the steam trigger fully. | Press the steam trigger fully for a few seconds. |
| | The water level in the water tank is too low or it has all been used up. | Unplug the appliance and refill the water tank. |
| | Steam plate is placed in a horizontal position. | Use the appliance vertically, wait for a few seconds for the steam to be released. |

| Problem | Possible cause | Solution |
|---|--|--|
| Water droplets drop from the appliance steamer head. | The appliance has not been fully heated up. | To allow the appliance to fully heat up. |
| The appliance produces a pumping sound/the handle vibrates. | Water is pumped to the steamer head to be converted into steam. | This is normal. |
| | The water level in the water tank is too low or it has all been used up. | Unplug the appliance and refill the water tank. |
| Steamer head and/or handle is wet. | Filling door is not fully inserted. | Detach the tank and ensure filling door has been fully inserted. |
| | The tank has been overfilled with water residue around it. | Wipe off the water residue left on tank. |



ID

| Masalah | Kemungkinan penyebab | Solusi |
|------------------------------|--|--|
| Alat tidak memanass. | Alat terhubung ke stopkontak dengan benar atau tidak dihidupkan. | Periksa apakah steker listrik terpasang dengan benar dan stopkontak dindingnya berfungsi. Periksa apakah alat dihidupkan. |
| Alat tidak menghasilkan uap. | Alat terhubung ke stopkontak dengan benar atau tidak dihidupkan. | Periksa apakah steker listrik terpasang dengan benar dan stopkontak dindingnya berfungsi. Periksa apakah alat dihidupkan. |
| | Alat tidak cukup panas. | Biarkan alat memanass selama ≈ 30 detik (lampu 'uap-siap' akan menyala). Ketika alat siap digunakan, lampu akan mati. |
| | Anda belum menekan pemicu uap secara penuh. | Tekan pemicu uap secara penuh selama beberapa detik. |
| | Ketinggian air di dalam tangki terlalu rendah atau sudah habis. | Cabut steker alat dan isi ulang tangki air. |

| Masalah | Kemungkinan penyebab | Solusi |
|---|---|--|
| | Pelat uap diletakkan dalam posisi horizontal. | Gunakan alat secara vertikal, tunggu beberapa detik hingga uap keluar. |
| Air menetes dari kepala penyembur uap pada alat. | Alat belum panas sepenuhnya. | Biarkan alat memanaskan sepenuhnya. |
| Alat mengeluarkan bunyi memompa/pegangannya bergetar. | Air dipompa ke kepala penyembur uap untuk dihasilkan menjadi uap. | Hal ini normal. |
| | Ketinggian air di dalam tangki terlalu rendah atau sudah habis. | Cabut steker alat dan isi ulang tangki air. |
| Kepala penguap dan/atau pegangan basah. | Pintu pengisi tidak masuk sempurna. | Lepaskan tangki dan pastikan pintu pengisi sudah masuk sempurna. |
| | Tangki terlalu penuh dan sekitarnya dipenuhi sisa air. | Seka/keringkan sisa air pada tangki. |



KO

| 문제점 | 예상 원인 | 해결책 |
|--------------------|------------------------------------|---|
| 스팀기가 예열되지 않습니다. | 제품의 플러그가 꽂혀 있지 않거나 전원이 켜져 있지 않습니다. | 전원 플러그가 제대로 꽂혀있으며 벽면 콘센트가 작동하는지 확인하십시오. 제품이 켜져 있는지 확인하십시오. |
| 제품에서 스팀이 나오지 않습니다. | 제품의 플러그가 꽂혀 있지 않거나 전원이 켜져 있지 않습니다. | 전원 플러그가 제대로 꽂혀있으며 벽면 콘센트가 작동하는지 확인하십시오. 제품이 켜져 있는지 확인하십시오. |
| | 제품이 충분히 뜨거워지지 않았습니니다. | 제품이 예열될 때까지 30초간 기다립니다(스팀 준비 표시등 켜짐). 제품을 사용할 준비가 되면 표시등이 꺼집니다. |
| | 스팀 버튼을 제대로 누르지 않았습니니다. | 스팀 버튼을 몇 초간 꼭 누르고 있습니다. |
| | 물탱크의 수위가 너무 낮거나 물이 전부 사용되었습니다. | 제품의 전원 코드를 뽑고 물탱크를 다시 채우십시오. |

| 문제점 | 예상 원인 | 해결책 |
|--------------------------|--------------------------------|--|
| | 스팀 열판이 수평으로 놓여 있습니다. | 제품을 수직으로 사용하고 스팀이 분사될 때까지 몇 초간 기다리십시오. |
| 제품의 스팀머 헤드에서 물방울이 떨어집니다. | 제품이 완전히 가열되지 않았습니다. | 제품이 완전히 가열될 때까지 기다리십시오. |
| 제품에서 펌프 소리가 나고 핸들이 떨립니다. | 물이 스팀머 헤드로 공급되면서 스팀으로 변환됩니다. | 이는 정상적인 현상입니다. |
| | 물탱크의 수위가 너무 낮거나 물이 전부 사용되었습니다. | 제품의 전원 코드를 뽑고 물탱크를 다시 채우십시오. |
| 스팀머 헤드 및/또는 핸들이 젖은 경우 | 주입 도어가 완전히 삽입되지 않았습니다. | 물탱크를 분리하고 주입 도어가 완전히 삽입되었는지 확인하십시오. |
| | 물탱크 주위에 물 잔여물이 너무 많이 채워져 있습니다. | 물탱크에 남아 있는 물 잔여물을 닦아내십시오. |



MS

| Masalah | Penyebab yang mungkin | Penyelesaian |
|--|--|---|
| Perkakas tidak menjadi panas dengan. | Palam perkakas tidak dipasang dengan betul atau tidak dihidupkan. | Pastikan palam sesalur kuasa dimasukkan dengan betul ke dalam soket dinding dan soket dinding itu berfungsi dengan betul. Pastikan perkakas dihidupkan. |
| Perkakas tidak menghasilkan sebarang stim. | Palam perkakas tidak dipasang dengan betul atau tidak dihidupkan. | Pastikan palam sesalur kuasa dimasukkan dengan betul ke dalam soket dinding itu berfungsi dengan betul. Pastikan perkakas dihidupkan. |
| | Perkakas tidak memanaskan dengan secukupnya. | Biar perkakas menjadi panas selama ≈ 30 saat (lampu "stim sedia" akan bernyala). Apabila perkakas sedia untuk digunakan, lampu akan mati. |
| | Anda tidak menekan picu stim sepenuhnya. | Tekan picu stim dengan sepenuhnya selama beberapa saat. |
| | Paras air di dalam tangki terlalu rendah atau telah habis digunakan. | Cabut palam perkakas dan isi semula tangki air. |

| Masalah | Penyebab yang mungkin | Penyelesaian |
|--|--|---|
| | Plat stim diletakkan dalam kedudukan mendatar. | Gunakan perkakas secara menegak, tunggu beberapa saat untuk stim dikeluarkan. |
| Titisan air menitik dari kepala penstim perkakas. | Perkakas belum panas dengan sepenuhnya. | Untuk membolehkan perkakas menjadi panas dengan sepenuhnya. |
| Perkakas menghasilkan bunyi mengepam/ pemegang bergetar. | Air dipamkan ke kepala penstim untuk ditukarkan kepada stim. | Ini perkara biasa. |
| | Paras air di dalam tangki terlalu rendah atau telah habis digunakan. | Cabut palam perkakas dan isi semula tangki air. |
| Kepala penstim dan/ atau pemegang basah. | Penutup pengisi tangki tidak dimasukkan dengan sepenuhnya. | Tanggalkan tangki dan pastikan penutup pengisi tangki telah dimasukkan dengan sepenuhnya. |
| | Tangki diisi berlebihan dengan sisa air di sekelilingnya. | Lap sisa air pada tangki. |



TH

| ปัญหา | สาเหตุที่เป็นไปได้ | การแก้ปัญหา |
|--------------------------|--|---|
| เครื่องไม่ร้อน | เครื่องอาจเสียบปลั๊กไฟไม่ถูกต้องหรือไม่ได้เปิดอยู่ | ให้ตรวจสอบว่าได้เสียบปลั๊กไฟอย่างถูกต้องและเต้ารับบนผนังใช้งานได้หรือไม่ ให้ตรวจสอบว่าเครื่องเปิดอยู่หรือไม่ |
| เครื่องไม่สร้างพลังไอน้ำ | เครื่องอาจเสียบปลั๊กไฟไม่ถูกต้องหรือไม่ได้เปิดอยู่ | ให้ตรวจสอบว่าได้เสียบปลั๊กไฟอย่างถูกต้องและเต้ารับบนผนังใช้งานได้หรือไม่ ให้ตรวจสอบว่าเครื่องเปิดอยู่หรือไม่ |
| | เครื่องยังทำความร้อนไม่เพียงพอ | ปล่อยให้เครื่องทำความร้อนประมาณ 30 วินาที (ไฟไอน้ำพร้อมใช้งาน" จะติดขึ้น) เมื่อเครื่องพร้อมทำการใช้งานไฟจะดับลง |
| | คุณอาจไม่ได้กดปุ่มใช้พลังไอน้ำลงจนสุด | กดปุ่มใช้พลังไอน้ำลงจนสุดค้างไว้สักครู่ |
| | แท่งค้ำมีระดับน้ำต่ำเกินไปหรือน้ำถูกใช้จนหมด | ถอดปลั๊กเครื่องแล้วเติมน้ำลงในแท่งค้ำ |
| | วางแผนไอน้ำในแนวอน | ใช้เครื่องในแนวตั้ง รอประมาณสองสามวินาทีเพื่อให้ไอน้ำระเหยออกมา |

| ปัญหา | สาเหตุที่เป็นไปได้ | การแก้ปัญหา |
|--|--|---|
| น้ำหยดออกจากหัว พ่นไอน้ำ | เครื่องยังร้อน ไม่พอ | เพื่อให้เครื่องร้อนเต็มที่ |
| เครื่องมีเสียงสูบน้ำ/ ด้ามจับสั่น | น้ำจะถูกสูบไปที่หัว พ่นไอน้ำเพื่อเปลี่ยน เป็นไอน้ำ | เป็นเหตุการณ์ปกติ |
| | แท่งค้ำมีระดับน้ำ ต่ำเกินไปหรือน้ำถูก ใช้จนหมด | ถอดปลั๊กเครื่องแล้วเติมน้ำลง ในแท่งค้ำ |
| หัวพ่นไอน้ำและ/ หรือที่จับเปียกชื้น | เสียงของเติมน้ำไม่ แน่น | ถอดแท่งค้ำออกและตรวจดูให้ แน่ใจว่าช่องเติมน้ำถูกเสียบ เข้าไปจนสุด |
| | ใส่น้ำในแท่งค้ำ มากเกินไปจนมีน้ำขัง อยู่รอบๆ | เช็ดน้ำขังที่เหลือนบนแท่งค้ำ ออก |



VI

| Sự cố | Nguyên nhân có thể | Giải pháp |
|-------------------------------|--|---|
| Thiết bị không nóng lên. | Thiết bị không được cắm điện đúng cách hoặc không bật. | Kiểm tra xem phích cắm điện có được cắm đúng cách không và xem ổ điện có hoạt động không. Kiểm tra xem thiết bị có được bật chưa. |
| Thiết bị không phun hơi nước. | Thiết bị không được cắm điện đúng cách hoặc không bật. | Kiểm tra xem phích cắm điện có được cắm đúng cách không và xem ổ điện có hoạt động không. Kiểm tra xem thiết bị có được bật chưa. |
| | Thiết bị vẫn chưa đủ nóng. | Để thiết bị làm nóng lên trong ≈ 30 giây (đèn báo 'hơi nước sẵn sàng' sẽ bật sáng). Khi thiết bị đã sẵn sàng để sử dụng, đèn sẽ tắt. |
| | Bạn vẫn chưa ấn nút bấm hơi nước hoàn toàn. | Ấn nút bấm hơi nước hoàn toàn trong vài giây. |
| | Ngăn chứa nước còn ít nước hoặc hết nước. | Rút phích cắm của thiết bị và đổ nước vào ngăn chứa nước. |
| | Mặt đế bàn ủi được đặt ở tư thế nằm ngang. | Đặt thiết bị theo chiều thẳng đứng, chờ vài giây để hơi nước nhả ra. |

| Sự cố | Nguyên nhân có thể | Giải pháp |
|--|---|---|
| Nước nhỏ giọt từ đầu bàn ủi hơi nước. | Thiết bị chưa đủ nóng. | Để thiết bị nóng lên hoàn toàn. |
| Thiết bị phát ra tiếng kêu ộp ộp/tay cầm rung. | Nước được bơm đến đầu bàn ủi hơi nước để chuyển thành hơi nước. | Đây là hiện tượng bình thường. |
| | Ngăn chứa nước còn ít nước hoặc hết nước. | Rút phích cắm của thiết bị và đổ nước vào ngăn chứa nước. |
| Đầu bàn ủi và/hoặc tay cầm bị ướt. | Cửa châm nước không được lấp chặt. | Tháo ngăn chứa nước và đảm bảo lấp chặt cửa châm nước. |
| | Ngăn chứa nước đầy cạn vôi. | Lau sạch cặn vôi còn dư trong ngăn chứa nước. |



SC

| 问题 | 可能的原因 | 解决方法 |
|-------------|--------------------|--|
| 产品无法加热。 | 产品未正确插入电源插头或未打开电源。 | 检查电源插头是否正确插入，以及墙壁插座是否正常工作。检查是否已打开产品电源。 |
| 蒸汽挂烫机不能产生蒸汽 | 产品未正确插入电源插头或未打开电源。 | 检查电源插头是否正确插入，以及墙壁插座是否正常工作。检查是否已打开产品电源。 |
| | 产品未充分加热。 | 让产品加热约 30 秒（“蒸汽就绪”指示灯将亮起）。当产品可供使用时，指示灯将关闭。 |
| | 您没有完全按下蒸汽开关。 | 完全按下蒸汽开关数秒钟。 |
| | 水箱中的水位太低或水已用完。 | 拔掉产品的电源插头，然后为水箱加水。 |

| 问题 | 可能的原因 | 解决方法 |
|-----------------|-----------------|--------------------|
| | 蒸汽面板放在了水平位置上。 | 垂直使用产品，等待几秒钟以释放蒸汽。 |
| 有水滴从产品的蒸汽喷头中滴出。 | 产品未完全加热。 | 将产品完全加热。 |
| 产品会产生抽水声/手柄震动。 | 水被抽到蒸汽喷头以转化为蒸汽。 | 这是正常的。 |
| | 水箱中的水位太低或水已用完。 | 拔掉产品的电源插头，然后为水箱加水。 |
| 蒸汽喷头和/或手柄潮湿。 | 注水口未完全插入。 | 拆下水箱，并确保注水口已完全插入。 |
| | 水箱注水过满，上面有积水。 | 擦去水箱上的积水。 |



TC

| 問題 | 可能原因 | 方法 |
|------------|-------------------|--|
| 產品未加熱。 | 產品未正確插上電源，或電源未開啟。 | 檢查電源插頭是否正確插上，以及插座供電正常。 檢查產品電源是否已開啟。 |
| 產品不會產生蒸氣。 | 產品未正確插上電源，或電源未開啟。 | 檢查電源插頭是否正確插上，以及插座供電正常。 檢查產品電源是否已開啟。 |
| | 產品加熱溫度不夠。 | 讓產品加熱約 30 秒（「蒸氣就緒」指示燈會亮起）。 。產品準備就緒可供使用時，指示燈會熄滅。 |
| | 您尚未完全按下蒸氣觸動器。 | 將蒸氣觸動器完全按到底數秒。 |
| | 水箱內的水位過低或用光了。 | 拔除產品插頭，並添加水箱內的水。 |
| | 蒸氣噴頭放於水平位置。 | 垂直使用產品，稍等幾秒鐘的時間讓蒸氣釋放。 |
| 產品蒸氣噴頭會滴水。 | 產品沒有充分加熱。 | 讓產品充分加熱。 |

| 問題 | 可能原因 | 方法 |
|----------------|-----------------|-------------------|
| 產品發出汲水聲音/握把震動。 | 水正被送往蒸氣噴頭轉換成蒸氣。 | 此為正常現象。 |
| | 水箱內的水位過低或用光了。 | 拔除產品插頭，並添加水箱內的水。 |
| 蒸氣噴頭及/或握把潮溼。 | 注水口門未完全插入。 | 拆下水箱，確保注水口門已完全插入。 |
| | 水箱過滿，溢出來的水流到周遭。 | 擦掉多餘的水。 |





©2020 Koninklijke Philips N.V.
All rights reserved.
4239 001 19971

