

Powered by



# GP 12650 ▶ 12V 65Ah

GP 12650 is a general purpose battery up to 5 years in standby service or more than 260 cycles at 100% discharge in cycle service. As with all CSB batteries, all are rechargeable, highly efficient, leak proof and maintenance free.



## Specification

Cells Per Unit	6
Voltage Per Unit	12
Capacity	65A h @ 20hr-rate to 1.75V per cell @25°C (77°F)
Weight	Approx. 20 kg(44.09 lbs)
Maximum Discharge Current	500A(5sec)
Internal Resistance	Approx. 8 mΩ
Operating Temperature Range	Discharge: -15°C~50°C ( 5°F~122°F) Charge: -15°C~40°C ( 5°F~104°F) Storage: -15°C~40°C ( 5°F~104°F)
Nominal Operating Temperature Range	25°C±3°C ( 77°F±5°F)
Float Charging Voltage	13.5 to 13.8 VDC/unit Average at 25°C (77°F)
Recommended Maximum Charging Current Limit	19.50A
Equalization and Cycle Service	14.4 to 15.0 VDC/unit Average at 25°C (77°F)
Self Discharge	CSB Batteries can be stored for more than 6 months at 25°C (77°F). Please charge batteries before using. For higher temperatures the time interval will be shorter.
Terminal	B4-L terminal to accept M6 nut & bolt
Container Material	Polypropylene(UL 94-V0) & Flammability resistance of (UL 94-HB) can be available upon request.



CSB-manufactured VRLA batteries are UL-recognized components under UL924 and UL1989.

CSB is also certified by ISO 9001 and ISO 14001.

Dimensions :	Overall Height (H)	Container height (h)	Length (L)	Width (W)
Unit: mm (inch)	174±2 (6.85±0.08)	172.5±2 (6.79±0.08)	349.9±2.5 (13.75±0.1)	166±2 (6.53±0.08)

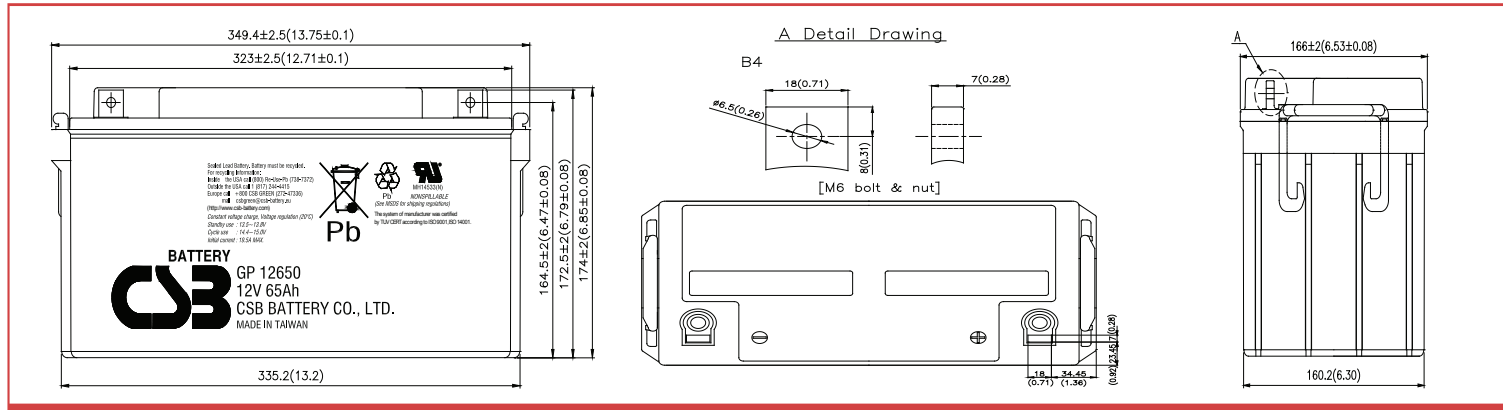

### Constant Current Discharge Characteristics Unit:A (25°C,77°F)

F.V/Time	5MIN	10MIN	15MIN	30MIN	60MIN	90MIN	2HR	3HR	5HR	8HR	10HR	20HR
1.60V	271	173	132	79.9	47.2	34.2	27.3	19.4	12.4	8.08	6.58	3.57
1.67V	242	162	124	78.3	46.9	34.1	27.2	19.3	12.3	7.97	6.47	3.42
1.70V	229	157	121	77.3	46.7	34.0	27.1	19.2	12.2	7.93	6.43	3.36
1.75V	208	147	117	75.4	46.4	33.8	27.0	19.1	12.1	7.86	6.32	3.25
1.80V	186	137	111	73.4	45.9	33.6	26.9	19.0	12.0	7.76	6.21	3.14
1.85V	164	127	105	71.3	45.4	33.3	26.8	18.9	11.9	7.66	6.10	3.03

### Constant Power Discharge Characteristics Unit:W (25°C,77°F)

F.V/Time	5MIN	10MIN	15MIN	30MIN	60MIN	90MIN	2HR	3HR	5HR	8HR	10HR	20HR
1.60V	3250	2080	1580	959	566	411	327	232	148	97.0	79.0	40.9
1.67V	2900	1940	1503	935	562	409	326	231	147	96.0	77.7	39.2
1.70V	2750	1871	1460	924	560	407	325	230	146	95.5	77.1	38.4
1.75V	2490	1760	1400	903	555	405	324	229	145	94.3	75.8	37.1
1.80V	2230	1640	1330	881	550	403	323	228	144	93.1	74.5	35.7
1.85V	1970	1520	1260	856	545	400	322	227	143	91.9	73.2	34.4

Ratings presented herein are subject to revision without notice. Please refer to [www.csb-battery.com](http://www.csb-battery.com) to confirm the latest version.

### Trickle (or Float) Service Life

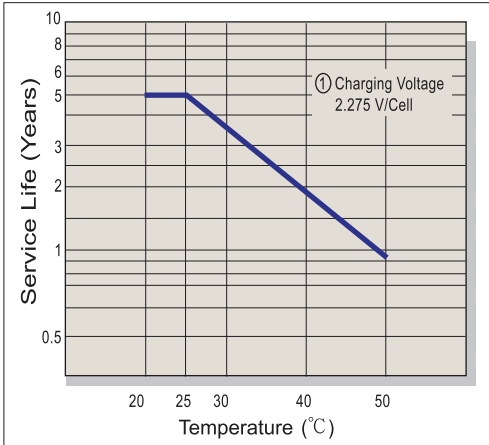

### Capacity Retention Characteristic

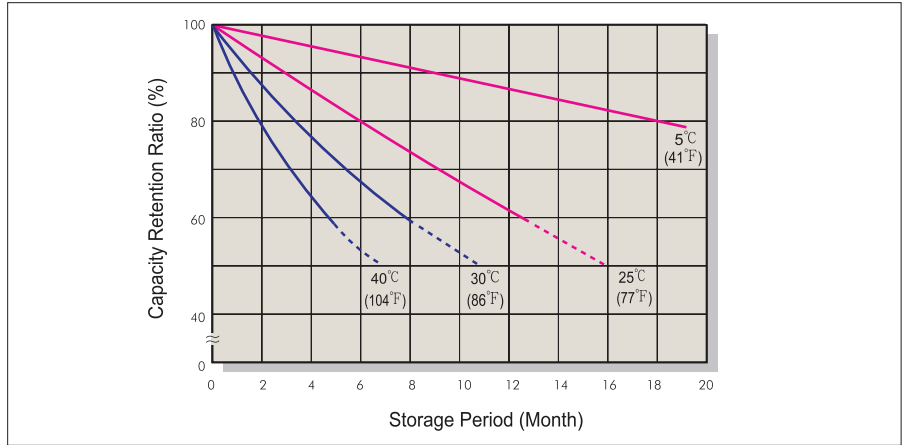

### Battery Voltage and Charge Time for Standby Use

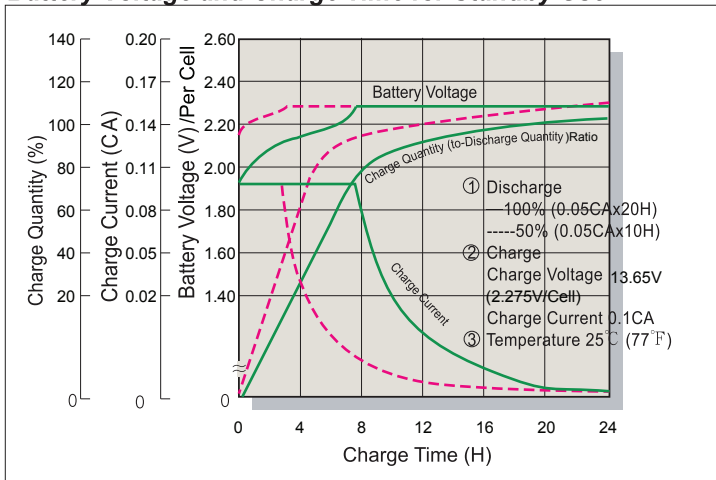

### Cycle Service Life

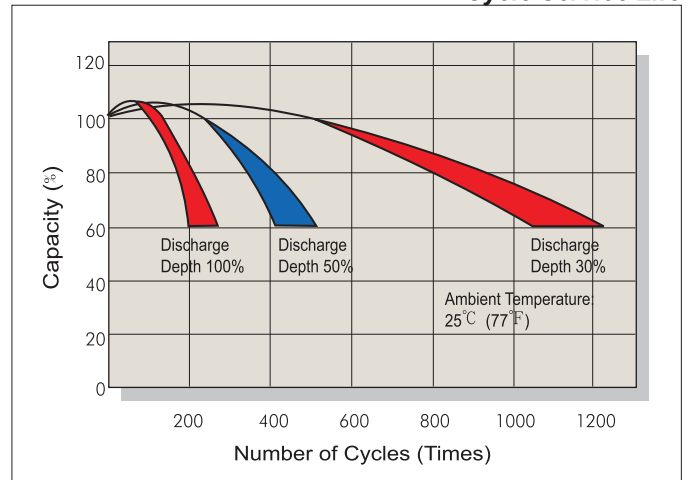

### Battery Voltage and Charge Time for Cycle Use

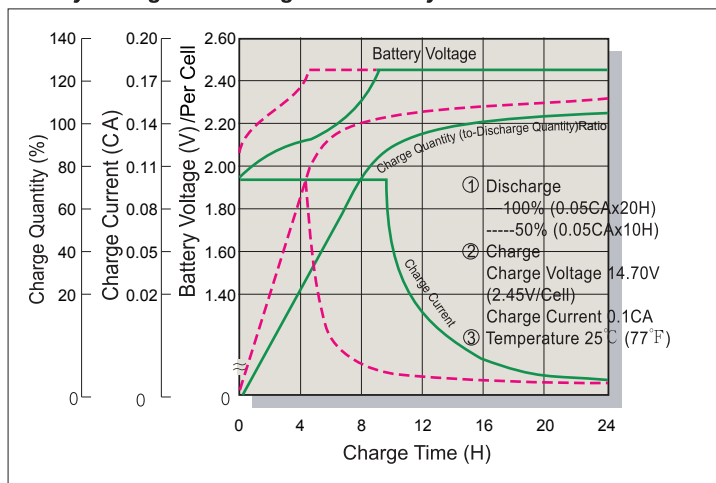

### Terminal Voltage (V) and Discharge Time

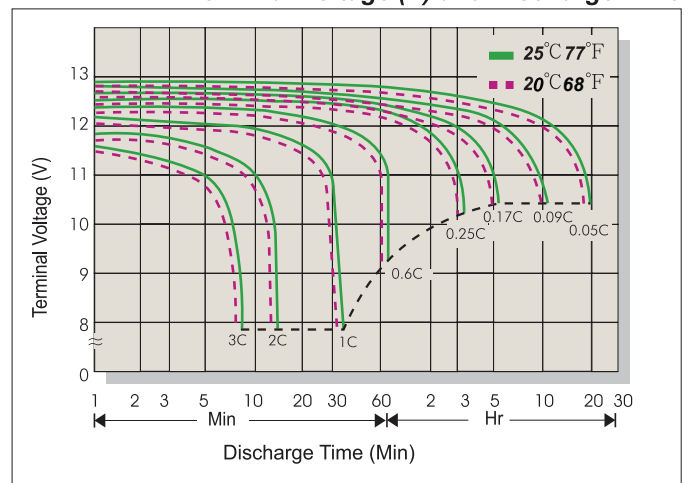

### Charging Procedures

Application	Charge Voltage(V/Cell)			Max.Charge Current
	Temperature	Set Point	Allowable Range	
Cycle Use	25°C (77°F)	2.45	2.40~2.50	0.3C
Standby	25°C (77°F)	2.275	2.25~2.30	

### Discharge Current VS. Discharge Voltage

Final Discharge Voltage V/Cell	1.75	1.70	1.60	1.30
Discharge Current(A)	0.2C>(A)	0.2C<(A)<0.5C	0.5C<(A)<1.0C	(A)>1.0C

Sales Office URL: [WWW.CSB-BATTERY.COM](http://WWW.CSB-BATTERY.COM)

**GLOBAL HQ**  
**CSB BATTERY CO., LTD. (TAIWAN)**  
 Tel : +886-2-2880-5600  
 Fax : +886-2-2888-3300  
 mail : service@csb-battery.com.tw

**BEIJING OFFICE. (CHINA)**  
**CSB BATTERY TECHNOLOGIES (BEIJING) CO., LTD.**  
 Tel : +86-10-5820-5336/5338  
 Fax : +86-10-58203053  
 mail : chinasl@csb-battery.com

**AMERICA HQ**  
**CSB BATTERY TECHNOLOGIES INC. (U.S.A)**  
 Tel : +1-817-244-7777/1-(800)3-CSB-USA(272872)  
 Fax : +1-817-244-4445  
 mail : csb@csb-battery.com

**SHANGHAI OFFICE. (CHINA)**  
**CSB BATTERY LOGISTIC (SHANGHAI) CO., LTD.**  
 Tel : +86-21-5046-1622/5046-0833  
 Fax : +86-21-5064-1046  
 mail : chinasl@csb-battery.com

**EUROPE HQ**  
**CSB Battery Europe BV.**  
 Tel : +31(0)-180-418-140  
 Fax : +31(0)-180-418-327  
 mail : eurosales@csb-battery.eu

**SHENZHEN OFFICE. (CHINA)**  
**CSB BATTERY LOGISTIC (SHANGHAI) CO., LTD.**  
 Tel : +86-755-8831-6488/6396/6356  
 Fax : +86-755-8831-6548  
 mail : she@csb-battery.com.cn