



User Guide

© Copyright 2019 HP Development Company, L.P.

HDMI, the HDMI Logo and High-Definition Multimedia Interface are trademarks or registered trademarks of HDMI Licensing LLC. Windows is either a registered trademark or trademark of Microsoft Corporation in the United States and/or other countries. DisplayPort™, the DisplayPort™ logo, and VESA® are trademarks owned by the Video Electronics Standards Association (VESA) in the United States and other countries.

The information contained herein is subject to change without notice. The only warranties for HP products and services are set forth in the express warranty statements accompanying such products and services. Nothing herein should be construed as constituting an additional warranty. HP shall not be liable for technical or editorial errors or omissions contained herein.

Product notice





This guide describes features that are common to most models. Some features may not be available on your product. To access the latest user guide, go to <http://www.hp.com/support>, and follow the instructions to find your product. Then select **User Guides**.

First Edition: October 2019

Document Part Number: L77075-001

About this guide

This guide provides information about monitor features, setting up the monitor, using the software and technical specifications.

-
-  **WARNING!** Indicates a hazardous situation that, if not avoided, **could** result in serious injury or death.
 -  **CAUTION:** Indicates a hazardous situation that, if not avoided, **could** result in minor or moderate injury.
 -  **IMPORTANT:** Indicates information considered important but not hazard-related (for example, messages related to property damage). Warns the user that failure to follow a procedure exactly as described could result in loss of data or in damage to hardware or software. Also contains essential information to explain a concept or to complete a task.
 -  **NOTE:** Contains additional information to emphasize or supplement important points of the main text.
 -  **TIP:** Provides helpful hints for completing a task.
-



This product incorporates HDMI technology.

Table of contents

| | |
|--|-----------|
| 1 Getting started | 1 |
| Important safety information | 1 |
| Product features and components | 2 |
| Features | 2 |
| Rear components | 3 |
| Front components | 4 |
| Setting up the monitor | 4 |
| Attaching the monitor stand | 5 |
| Mounting the monitor head | 6 |
| Removing the monitor stand | 6 |
| Attaching the monitor head to a mounting device | 7 |
| Connecting the cables | 8 |
| Adjusting the monitor | 10 |
| Turning on the monitor | 12 |
| Installing a security cable | 13 |
| 2 Using the monitor | 14 |
| Software and utilities | 14 |
| The Information file | 14 |
| The Image Color Matching file | 14 |
| Using the OSD menu | 15 |
| Using the function buttons | 16 |
| Reassigning the function buttons | 16 |
| Adjusting blue light output (select products only) | 16 |
| Using Auto-Sleep Mode | 17 |
| Changing the Power Mode setting | 17 |
| 3 Support and troubleshooting | 18 |
| Solving common issues | 18 |
| Button lockouts | 19 |
| Using the auto-adjustment function (analog input) | 19 |
| Optimizing image performance (analog input) | 20 |
| Contacting support | 21 |
| Preparing to call technical support | 21 |
| Locating the serial number and product number | 22 |

| | |
|---|-----------|
| 4 Maintaining the monitor | 23 |
| Maintenance guidelines | 23 |
| Cleaning the monitor | 23 |
| Shipping the monitor | 24 |
| Appendix A Technical specifications | 25 |
| Preset display resolutions | 26 |
| Energy saver feature | 27 |
| Appendix B Accessibility | 28 |
| HP and accessibility | 28 |
| Finding the technology tools you need | 28 |
| The HP commitment | 28 |
| International Association of Accessibility Professionals (IAAP) | 28 |
| Finding the best assistive technology | 29 |
| Assessing your needs | 29 |
| Accessibility for HP products | 29 |
| Standards and legislation | 30 |
| Standards | 30 |
| Mandate 376 – EN 301 549 | 30 |
| Web Content Accessibility Guidelines (WCAG) | 30 |
| Legislation and regulations | 30 |
| Useful accessibility resources and links | 31 |
| Organizations | 31 |
| Educational institutions | 31 |
| Other disability resources | 31 |
| HP links | 32 |
| Contacting support | 32 |

1 Getting started

Important safety information

A power cord is included with the monitor. If you use another cord, use only a power source and connection appropriate for this monitor. For information about the correct power cord set to use with the monitor, see the *Product Notices* provided in your documentation kit.

 **WARNING!** To reduce the risk of electric shock:

- Plug the power cord into an AC outlet that is easily accessible at all times.
- If the power cord has a 3-pin attachment plug, plug the cord into a grounded (earthed) 3-pin outlet.

For your safety, do not place anything on power cords or cables. Care should be taken to route all cords and cables connected to the monitor so that they cannot be stepped on, pulled, grabbed, or tripped over.

To reduce the risk of serious injury, read the *Safety & Comfort Guide* provided with your user guides. It describes proper workstation setup and proper posture, health, and work habits for computer users. The *Safety & Comfort Guide* also provides important electrical and mechanical safety information. The *Safety & Comfort Guide* is also available on the Web at <http://www.hp.com/ergo>.

 **IMPORTANT:** For the protection of the monitor and the computer, connect all power cords for the computer and its peripheral devices (such as a monitor, printer, scanner) to a surge protection device such as a power strip or uninterruptible power supply (UPS). Not all power strips provide surge protection; the power strip must be specifically labeled as having this capability. Use a power strip whose manufacturer offers a damage replacement policy so that you can replace the equipment if surge protection fails.

Use the appropriate and correctly sized furniture designed to properly support your monitor.

 **WARNING!** Monitors that are inappropriately situated on dressers, bookcases, shelves, desks, speakers, chests, or carts may fall over and cause personal injury.

 **NOTE:** This product is suitable for entertainment purposes. Consider placing the monitor in a controlled luminous environment to avoid interference from surrounding light and bright surfaces that may cause disturbing reflections from the screen.

Product features and components

Features

The monitor features include the following:

- 68.6 cm (27.0 in) diagonal viewable screen area with 2560 × 1440 resolution
- Antiglare panel with an LED backlight
- Wide viewing angle to allow viewing from a sitting or standing position, or when moving from side to side
- Tilt capability
- Pivot capability to rotate the monitor head from landscape to portrait mode
- Swivel and height adjustment capabilities
- Removable stand for flexible monitor head mounting solutions
- One DisplayPort™ video input (cable not provided)
- One HDMI (High-Definition Multimedia Interface) video input (cable provided)
- Plug and Play capability, if supported by your operating system
- Security cable slot provision on rear of monitor for optional security cable
- On-screen display (OSD) adjustments in several languages for easy setup and screen optimization
- HP Display Assistant software for adjusting monitor settings and enabling the theft deterrent features
- HDCP (High-bandwidth Digital Content Protection) copy protection on all digital inputs
- Energy saver feature to meet requirements for reduced power consumption



NOTE: For safety and regulatory information, see the *Product Notices* provided on your optical disc, if one is included, or in your documentation kit. To access the latest user guide, go to <http://www.hp.com/support> and follow the instructions to find your product. Then select **User Guides**.

Rear components

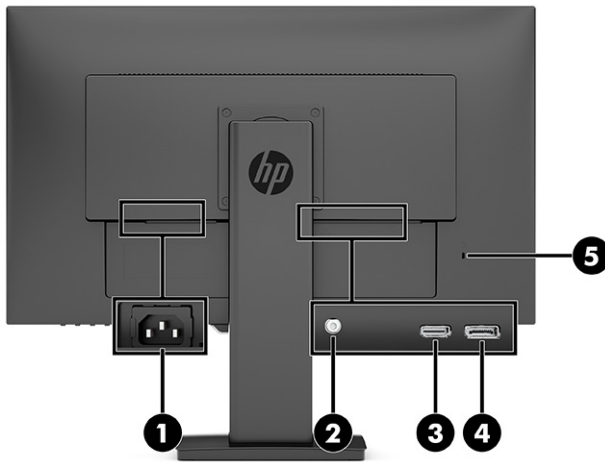

Table 1-1 Rear components

| Component | Function |
|-----------------------------|---|
| 1 Power connector | Connects the power cord. |
| 2 Audio-in (headphone) jack | Connects optional powered stereo speakers, headphones, earbuds, or a television audio cable. CAUTION: To reduce the risk of personal injury, adjust the volume before using headphones or earbuds. For additional safety information, see the Product Notices provided in your documentation kit. |
| 3 HDMI port | Connects the HDMI cable to a source device such as a computer or game console. |
| 4 DisplayPort connector | Connects the DisplayPort cable to a source device such as a computer or game console. |
| 5 Security cable slot | Connects an optional security cable. |

Front components

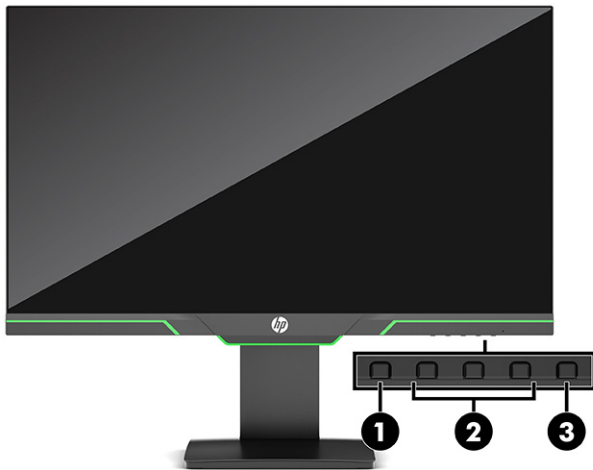

Table 1-2 Front components

| Control | Function |
|----------------------------------|--|
| 1 Menu button | Press to open the OSD menu, select a menu item from the OSD, or close the OSD menu. When the OSD menu is open, the Menu light turns on. |
| 2 OSD buttons (assignable) | When the OSD menu is open, press the buttons to navigate through the menu. The function light icons indicate the default button functions. For a description of these functions, see Using the function buttons on page 16 . You can reassign the function buttons to quickly select the most commonly used operations. See Reassigning the function buttons on page 16 . |
| 3 Power button | Turns the monitor on or off. |

Setting up the monitor

WARNING! To reduce the risk of serious injury, read the *Safety & Comfort Guide*. It describes proper workstation setup and proper posture, health, and work habits for computer users. The *Safety & Comfort Guide* also provides important electrical and mechanical safety information. The *Safety & Comfort Guide* is available on the Web at <http://www.hp.com/ergo>.

IMPORTANT: To prevent damage to the monitor, do not touch the surface of the LCD panel. Pressure on the panel may cause nonuniformity of color or disorientation of the liquid crystals. If this occurs, the screen will not recover to its normal condition.

IMPORTANT: To prevent the screen from getting scratched, defaced, or broken and prevent damage to the control buttons, position the monitor facedown on a flat surface covered with protective sheet foam or a nonabrasive cloth.

Attaching the monitor stand

 **TIP:** Consider the placement of the monitor, because surrounding light and bright surfaces might cause interfering reflections.

1. Position the monitor facedown on a flat surface covered by a soft clean cloth.
2. Rotate the stand 90° counterclockwise.

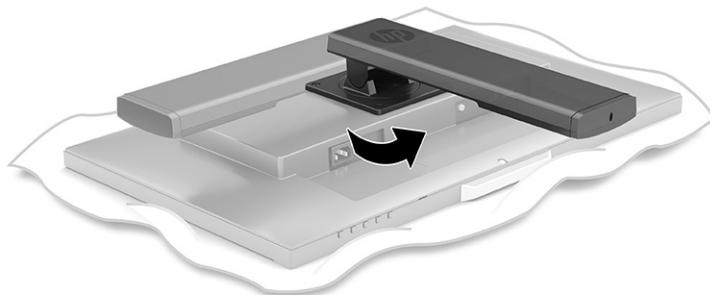

3. Insert the base into the bottom of the monitor stand (1), and then tighten the thumbscrew (2).

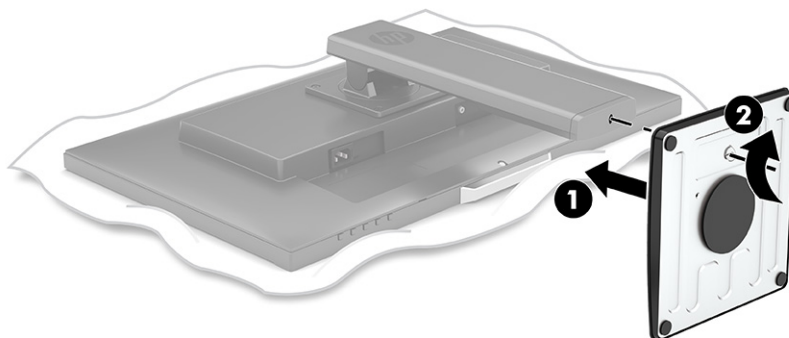

Mounting the monitor head

The monitor head can be attached to a wall, swing arm, or other mounting fixture.

 **NOTE:** This apparatus is intended to be supported by a UL or CSA Listed wall-mount bracket.

If the monitor is TCO certified, the power cord plugged into the monitor head must be a shielded power cable. The use of a shielded power cable meets the TCO-certified criteria for display products. For information on TCO requirements, go to www.tcodevelopment.com.

 **IMPORTANT:** This monitor supports the VESA industry standard 100 mm mounting holes. To attach a third-party mounting solution to the monitor head, four 4 mm, 0.7 pitch, and 10 mm long screws are required. Avoid longer screws because they can damage the monitor head. Be sure to verify that the manufacturer's mounting solution is compliant with the VESA standard and is rated to support the weight of the monitor head. For best performance, use the power and video cables provided with the monitor.

Removing the monitor stand

You can remove the monitor panel from the stand to install the monitor panel on a wall, a swing arm, or other mounting fixture.

1. Disconnect and remove all cables from the monitor.
2. Position the monitor facedown on a flat surface covered by a soft clean cloth.
3. Remove the four screws from the VESA® holes located on the rear of the monitor head, and then lift the stand off the monitor head.

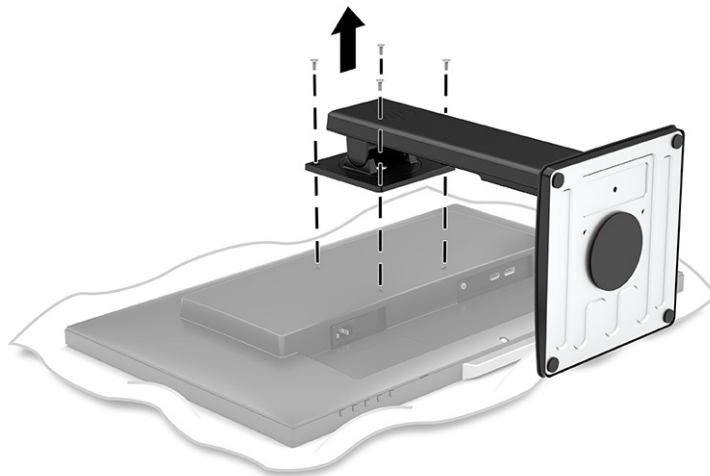

Attaching the monitor head to a mounting device

1. Remove the four screws from the VESA holes located on the rear of the monitor head.

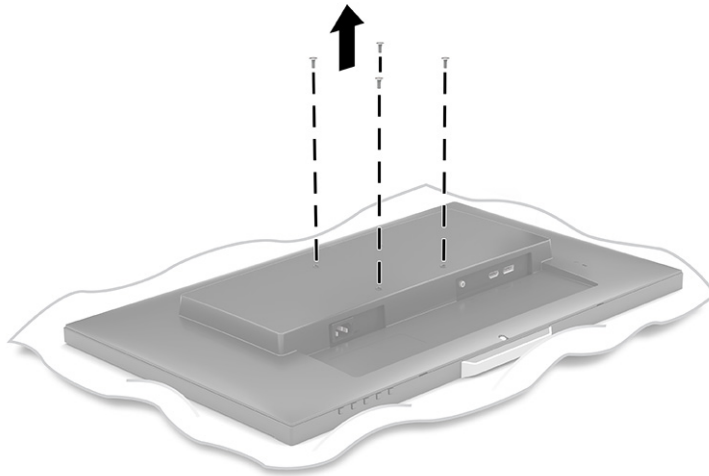

2. To attach the monitor head to a swing arm or other mounting device, insert four mounting screws through the holes on the mounting device and into the VESA screw holes on the back of the monitor head.

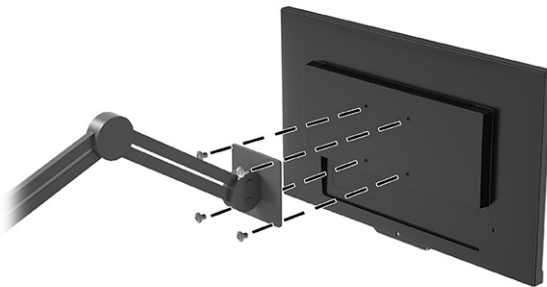

Connecting the cables

 **NOTE:** The monitor ships with select cables. Not all cables shown in this section are included with the monitor.

1. Place the monitor in a convenient, well-ventilated location near the computer.
2. Connect a video cable.

 **NOTE:** The monitor automatically determines which inputs have valid video signals. To select any input manually, open the OSD and select **Input**.

- Connect one end of a DisplayPort cable to the DisplayPort connector on the rear of the monitor and the other end to the DisplayPort connector on the source device.

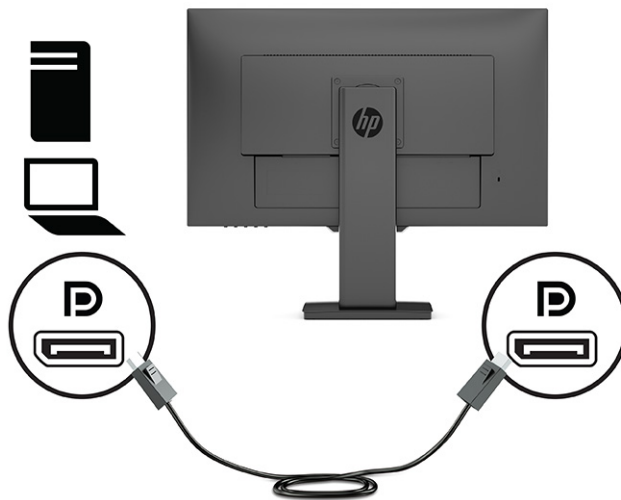

- Connect one end of an HDMI cable to the HDMI port on the rear of the monitor and the other end to the HDMI port on the source device.

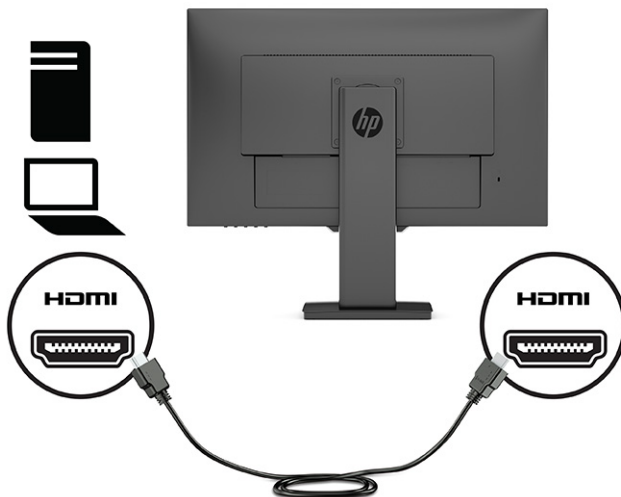

3. To enable sound from the monitor's speakers, connect one end of an audio cable (not included) to the audio-in jack on the monitor and the other end to the audio-out jack on the source device.

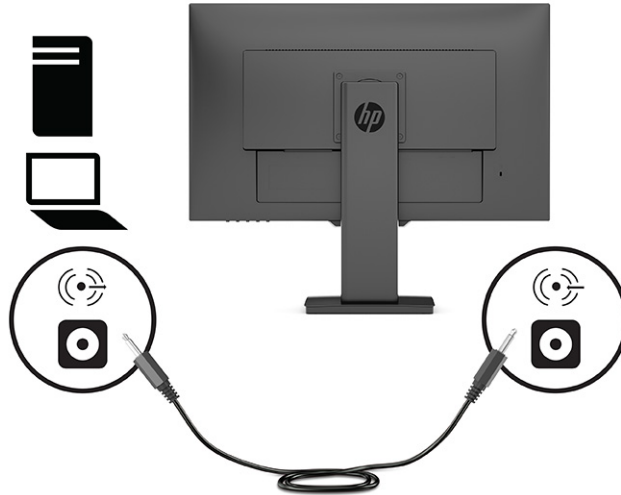

4. Connect one end of the power cord to the power connector on the rear of the monitor and the other end to a grounded AC outlet.

⚠ WARNING! To reduce the risk of electric shock or damage to the equipment:

Do not disable the power cord grounding plug. The grounding plug is an important safety feature.

Plug the power cord into a grounded (earthed) AC outlet that is easily accessible at all times.

Disconnect power from the equipment by unplugging the power cord from the AC outlet.

For your safety, do not place anything on power cords or cables. Arrange them so that no one may accidentally step on or trip over them. Do not pull on a cord or cable. When unplugging the power cord from the AC outlet, grasp the cord by the plug.

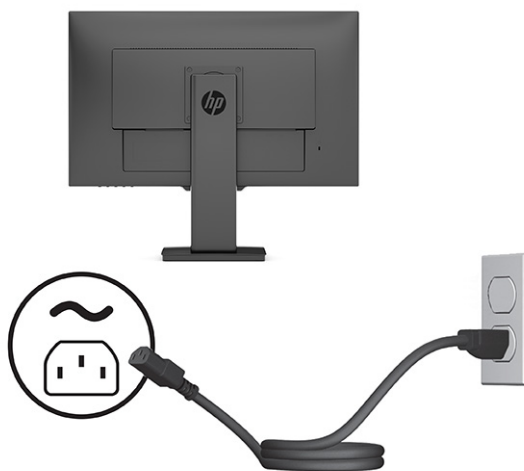

Adjusting the monitor

⚠ WARNING! To reduce the risk of serious injury, read the *Safety & Comfort Guide*. It describes proper workstation setup and proper posture, health, and work habits for computer users. The *Safety & Comfort Guide* also provides important electrical and mechanical safety information. The *Safety & Comfort Guide* is available on the Web at <http://www.hp.com/ergo>.

📝 NOTE: Do not touch the front of the monitor screen. When adjusting the tilt, swivel, and height, place a hand on the left and right side of the back of the monitor head and adjust as needed.

1. Tilt the monitor head forward or backward to set it to a comfortable eye level.

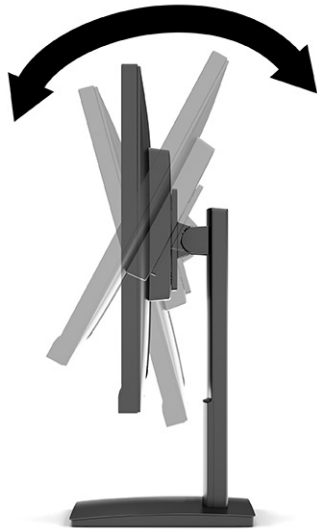

2. Swivel the monitor head to the left or right for the best viewing angle.

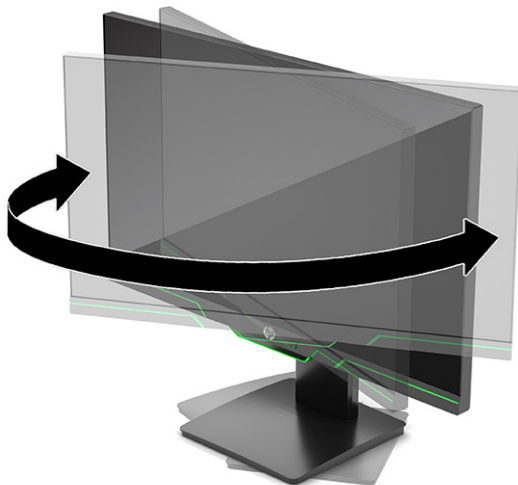

3. Adjust the monitor's height to a comfortable position for your individual workstation. The monitor's top bezel edge should not exceed a height that is parallel to your eye height. A monitor that is positioned low and reclined may be more comfortable for users with corrective lenses. The monitor should be repositioned as you adjust your working posture throughout the work day.

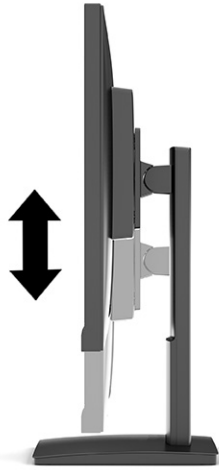



4. You can pivot the monitor panel from landscape to portrait orientation viewing to adapt to your application.
 - a. Adjust the monitor to full height position and tilt the monitor panel back to full tilt position **(1)**.
 - b. Pivot the monitor panel clockwise or counterclockwise 90° from landscape to portrait orientation **(2)**.

 **IMPORTANT:** If the monitor is not in full-height and full-tilt position when pivoting, the bottom right or left corner of the monitor panel will come in contact with the base and potentially cause damage to the monitor.



 **NOTE:** Use the operating system's display settings to rotate the image on the screen from portrait to landscape. To rotate the OSD from portrait to landscape, open the OSD menu and select **Image Adjustment**, select **On-Screen Menu Rotation**, and then select **Portrait**.

Turning on the monitor

-  **IMPORTANT:** Burn-in image damage can occur on monitors that display the same static image on the screen for 12 or more hours. To avoid burn-in image damage, you should always activate a screen saver application or turn off the monitor when it will not be in use for a prolonged period of time. Image retention can occur on any LCD screen. Burn-in damage on the monitor is not covered under the HP warranty.
-  **NOTE:** If pressing the power button has no effect, the Power Button Lockout feature could be enabled. To disable this feature, press and hold the monitor power button for 10 seconds.
-  **NOTE:** You can disable the power light in the OSD menu. Press the **Menu** button to open the OSD. Then select **Power**, select **Power LED**, and then select **Off**.

- ▲ Press the power button on the bottom of the monitor to turn it on.



When the monitor is first turned on, a monitor status message is displayed for 5 seconds. The message shows which input is the current active signal, the status of the auto-switch source setting (On or Off; default setting is On), the current preset display resolution, and the recommended preset display resolution.

The monitor automatically scans the signal inputs for an active input and uses that input for the display.

Installing a security cable

You can secure the monitor to a fixed object with an optional security cable available from HP. Use the key provided to attach and remove the lock.

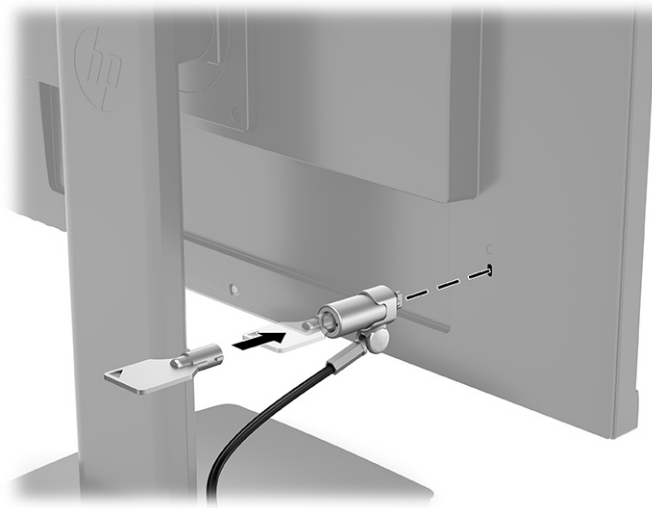

2 Using the monitor

Software and utilities

You can download and install the following files from <http://www.hp.com/support>:

- INF (Information) file
- ICM (Image Color Matching) files
- HP Display Assistant: Adjusts the monitor settings and enables theft deterrence features

To download the files:

1. Go to <http://www.hp.com/support>.
2. Select **Software and Drivers**.
3. Select your product type.
4. Enter your HP monitor model in the search field and follow the on-screen instructions.

The Information file

The INF file defines monitor resources used by Windows® operating systems to ensure monitor compatibility with the computer's graphics adapter.

This monitor is Windows Plug and Play-compatible and the monitor will work correctly without installing the INF file. Monitor Plug and Play-compatibility requires that the computer's graphics card is VESA DDC2-compliant and that the monitor connects directly to the graphics card. Plug and Play does not work through separate BNC-type connectors or through distribution buffers or boxes.

The Image Color Matching file

The ICM files are data files that are used in conjunction with graphics programs to provide consistent color matching from monitor screen to printer, or from scanner to monitor screen. This file is activated from within graphics programs that support this feature.



NOTE: The ICM color profile is written in accordance with the International Color Consortium (ICC) Profile Format specification.

Using the OSD menu

Use the OSD menu to adjust the screen image based on your viewing preferences. You can access and make adjustments in the OSD menu using the buttons on the monitor's front bezel.



NOTE: Changing the default settings may increase power consumption.

To access the OSD menu and make adjustments, do the following:

1. If the monitor is not already on, press the power button to turn on the monitor.
2. Press the **Menu** button.
3. Use the three function buttons to navigate, select, and adjust the menu choices. The on-screen button labels vary depending on which menu or submenu is active.

The following table lists menu selections in the OSD main menu.

Table 2-1 OSD menu options and descriptions for using a button (select products only)

| Main Menu | Description |
|---------------|--|
| Brightness | Adjusts the brightness level of the screen. The factory default is 90. |
| Contrast | Adjusts the contrast level of the screen. The factory default is 80. |
| Color Control | Selects and adjusts the screen color. |
| Input Control | Selects the video input signal. |
| Image Control | Adjusts the screen image. |
| Power Control | Adjusts the power settings. |
| Menu Control | Adjusts the on-screen display (OSD) and function button controls. |
| Management | Adjusts the DDC/CI settings and returns all OSD menu settings to the factory default settings. |
| Language | Selects the language in which the OSD menu is displayed. The factory default is English. |
| Information | Selects and displays important information about the monitor. |
| Exit | Exits the OSD menu screen. |

Using the function buttons

Pressing one of the three function buttons activates the buttons and displays the icons above the buttons. The factory default button icons and functions are shown in the following table.

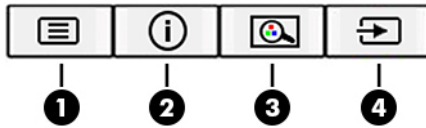

Table 2-2 Button names and functions

| Button | Function |
|---|---|
| 1 Menu button | Opens the OSD main menu, selects a menu item from the OSD, or closes the OSD menu. |
| 2 Information button (function button 3 - assignable) | Opens the Information menu. |
| 3 Viewing Modes button (function button 2 - assignable) | Opens the Viewing Modes menu where you can adjust the monitor screen to a comfortable viewing light or select a preset viewing mode. |
| 4 Next Active Input button (function button 1 - assignable) | Switches the monitor's input source to the next active input. |

Reassigning the function buttons

You can change the assignable function buttons from their default values so that when the buttons are activated you can quickly access commonly used menu items. You cannot reassign the **Menu** button.

To reassign the function buttons:

1. Press the **Menu** button to open the OSD menu.
2. Select **Menu**, select **Assign Buttons**, and then select one of the available options for the button you want to assign.



NOTE: To view an OSD menu simulator, visit the HP Customer Self Repair Services Media Library at <http://www.hp.com/go/sml>.

Adjusting blue light output (select products only)

Decreasing the blue light emitted by the monitor reduces the blue light exposure to your eyes. This monitor allows you to select a setting to reduce blue light output and create a more relaxing and less stimulating image while you read content on the screen.

To adjust the blue light output from the monitor:

1. Press one of the rear panel OSD buttons to activate the buttons, and then press the **Menu** button to open the OSD. Select **Color** and **Viewing Mode**.
2. Select the setting that you want.

- **Low Blue Light:** (TUV certified) Reduces blue light for improved eye comfort.
 - **Night:** Adjusts to the lowest blue light and reduces the impact on sleep.
 - **Reading:** Optimizes blue light and brightness for indoor viewing.
3. Select **Save and Return** to save your setting and close the menu. Select **Cancel** if you do not want to save the setting.
 4. In the Main menu, select **Exit**.

Using Auto-Sleep Mode

The monitor supports an on-screen display (OSD) menu option called Auto-Sleep Mode that allows you to enable or disable a reduced power state for the monitor. When Auto-Sleep Mode is enabled, the monitor enters a reduced power state when the host computer signals low power mode in the absence of either horizontal or vertical sync signal. Auto-Sleep Mode is enabled by default.

Upon entering this reduced power state (sleep mode), the monitor screen is blanked, the backlight is turned off, and the power light indicator turns amber. The monitor draws less than 0.5 W of power when in this reduced power state. The monitor wakes from the sleep mode when the host device sends an active signal to the monitor (for example, if you activate the mouse or keyboard).

To disable Auto-Sleep Mode:

1. Press the **Menu** button to open the OSD.
2. In the OSD menu, select **Power**, select **Auto-Sleep Mode**, and then select **Off**.

Changing the Power Mode setting

When in sleep mode, to comply with international power standards, the monitor default setting is Power Saver mode. If your display supports Performance mode, then to keep the USB ports enabled even when the monitor is in Auto-Sleep Mode, change the Power Mode setting from Power Saver to Performance.

To change the Power Mode setting:

1. Press the **Menu** button to open the OSD menu.
2. Select **Power**, select **Power Mode**, and then select **Performance**.
3. Select **Save** and close the OSD.

3 Support and troubleshooting

Solving common issues

The following table lists possible issues, the possible cause of each issue, and the recommended solutions.

Table 3-1 Common issues and solutions

| Issues | Possible cause | Solution |
|--|--|---|
| Screen is blank or video is flashing. | Power cord is disconnected. | Connect the power cord. |
| | Monitor is off. | Press the monitor power button. NOTE: If pressing the power button has no effect, press and hold the power button for 10 seconds to disable the Power Button Lockout feature. |
| | Video cable is improperly connected. | Connect the video cable properly. See Connecting the cables on page 8 for more information. |
| | System is in Auto-Sleep Mode. | Press any key on the keyboard or move the mouse to inactivate the screen blanking utility. |
| | Video card is incompatible. | Open the OSD menu and select the Input menu. Set Auto-Switch Input to Off and manually select the input. or Replace the video card or connect the video cable to one of the computer's on-board video sources. |
| Image appears blurred, indistinct, or too dark. | Brightness setting is too low. | Open the OSD menu, and select Brightness to adjust the brightness scale as needed. |
| "Check Video Cable" is displayed on the screen. | Monitor video cable is disconnected. | Connect the appropriate video signal cable between the computer and monitor. Be sure that the computer power is off while connecting the video cable. |
| "Input Signal Out of Range" is displayed on the screen. | Video resolution and/or refresh rate are set higher than the monitor supports. | Change the settings to a supported setting (see Preset display resolutions on page 26). |
| The monitor does not enter into a low-power sleep state. | The monitor's power saving control is disabled. | Open the OSD menu and select Power , select Auto-Sleep Mode , and then set auto-sleep to On . |
| "OSD Lockout" is displayed. | The monitor's OSD Lockout function is enabled. | Press and hold the Menu button for 10 seconds to disable the OSD Lockout function. |
| "Power Button Lockout" is displayed. | The monitor's Power Button Lockout feature is enabled. | Press and hold the Power button for 10 seconds to unlock the power button function. |

Button lockouts

Holding down the power button or **Menu** button for 10 seconds disables that button. You can re-enable the button by holding the button down again for 10 seconds. The button lockout function is available only when the monitor is on, an active signal is displayed, and the OSD menu is closed.

Using the auto-adjustment function (analog input)

The auto-adjustment feature automatically engages and attempts to optimize your screen under the following conditions:

- Monitor setup
- Factory reset of the computer
- Changing monitor resolution

You can manually optimize the screen performance for the VGA (analog) input at any time from the Auto Adjustment menu in the OSD. You can download the auto-adjustment pattern software utility from <http://www.hp.com/support>.

Do not use this procedure if the monitor is using an input other than VGA. If the monitor is using a VGA (analog) input, this procedure can correct the following image quality conditions:

- Fuzzy or unclear focus
- Ghosting, streaking, or shadowing effects
- Faint vertical bars
- Thin, horizontal scrolling lines
- An off-center picture

To use the auto-adjustment feature:

1. Turn the monitor on, and then wait for 20 minutes before adjusting.
2. Press the **Menu** button to open the OSD menu, select **Image**, and then select **Auto Adjustment**. If the result is not satisfactory, continue with the procedure.
3. Open the auto-adjustment utility. (You can download this utility from <http://www.hp.com/support>.) The setup test pattern is displayed.

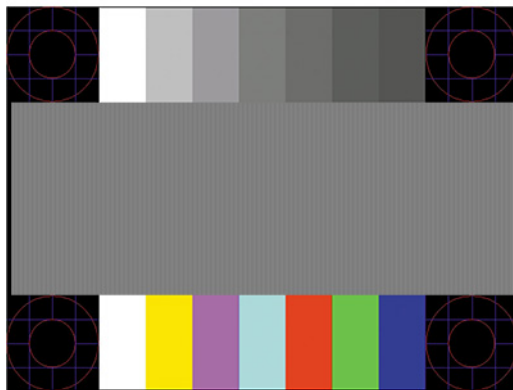

4. Press the **Esc** key or any other key on the keyboard to exit the test pattern.

Optimizing image performance (analog input)

You can adjust two controls in the on-screen display to improve image performance: Clock and Phase (available in the OSD menu). Use these controls only when the auto-adjustment function does not provide a satisfactory image.

 **NOTE:** The Clock and Phase controls are adjustable only when you use an analog (VGA) input. These controls are not adjustable for digital inputs.

The Clock must first be set correctly because the Phase settings are dependent on the main Clock setting.

- **Clock:** Increases or decreases the value to minimize any vertical bars or stripes visible on the screen background.
- **Phase:** Increases or decreases the value to minimize video flickering or blurring.

 **NOTE:** When using the controls, you will obtain the best results by using the auto-adjustment pattern software utility. You can download this utility from <http://www.hp.com/support>.

When adjusting the Clock and Phase values, if the monitor images become distorted, continue adjusting the values until the distortion disappears. To restore the factory settings, press the **Menu** button to open the OSD menu, then select **Management**, select **Factory Reset**, and select **Yes**.

To eliminate vertical bars (Clock):

1. Press the **Menu** button to open the OSD menu, select **Image**, and then select **Clock and Phase**.
2. Select **Clock**, and then use the OSD buttons on the monitor that display up and down arrow icons to eliminate vertical bars. Press the buttons slowly so that you do not miss the optimum adjustment point.



3. After adjusting the Clock, if flickering, blurring, or bars appear on the screen, proceed to adjust the Phase.

To remove flickering or blurring (Phase):

1. Press the **Menu** button to open the OSD menu, select **Image**, and then select **Clock and Phase**.
2. Select **Phase**, and then use the OSD buttons on the monitor that display up and down arrow icons to eliminate flickering or blurring. Flickering or blurring may not be eliminated, depending on the computer or graphics controller card installed.



To correct screen position (Horizontal Position or Vertical Position):

1. Press the **Menu** button to open the OSD menu, select **Image**, and then select **Image Position**.

2. Press the OSD buttons on the monitor that display up and down arrow icons to properly adjust the position of the image in the display area of the monitor. The **Horizontal Position** shifts the image left or right; the **Vertical Position** shifts the image up or down.

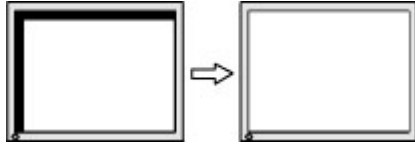

Contacting support

To resolve a hardware or software problem, go to <http://www.hp.com/support>. Use this site to get more information about your product, including links to discussion forums and instructions on troubleshooting. You can also find information about how to contact HP and open a support case.

 **NOTE:** Contact customer support to replace the power cord, the AC adapter (select products only), or any other cables that shipped with your monitor.

Preparing to call technical support

If you cannot solve a problem using the troubleshooting tips in this section, you may need to call technical support. Have the following information available when you call:

- Monitor model number
- Monitor serial number
- Purchase date on invoice
- Conditions under which the problem occurred
- Error messages received
- Hardware configuration
- Name and version of the hardware and software you are using

Locating the serial number and product number

Depending on the product, the serial number and product number are located on a label on the rear of the monitor or on a label under the front bezel of the monitor head. You might need these numbers when contacting HP about the monitor.

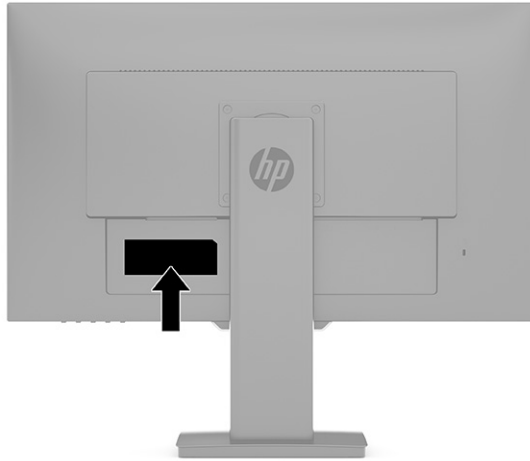

4 Maintaining the monitor

Maintenance guidelines

To enhance the performance and extend the life of the monitor:

- Do not open the monitor cabinet or attempt to service this product yourself. Adjust only those controls that are covered in the operating instructions. If the monitor is not operating properly or has been dropped or damaged, contact an authorized HP dealer, reseller, or service provider.
- Use only a power source and connection appropriate for this monitor, as indicated on the label or back plate of the monitor.
- Be sure that the total ampere rating of the products connected to the outlet does not exceed the current rating of the AC outlet and that the total ampere rating of the products connected to the cord does not exceed the rating of the cord. Look on the power label to determine the ampere rating (AMPS or A) for each device.
- Install the monitor near an outlet that you can easily reach. Disconnect the monitor by grasping the plug firmly and pulling it from the outlet. Never disconnect the monitor by pulling the cord.
- Turn the monitor off when it is not in use and use a screen saver program. Doing this can substantially increase the life expectancy of the monitor.



NOTE: A burned-in image on the monitor is not covered under the HP warranty.

- Never block the slots and openings of the cabinet or push objects into them. These openings provide ventilation.
- Do not drop the monitor or place it on an unstable surface.
- Do not allow anything to rest on the power cord. Do not walk on the cord.
- Keep the monitor in a well-ventilated area, away from excessive light, heat, or moisture.

Cleaning the monitor

1. Turn off the monitor and unplug the power cord from the AC outlet.
2. Disconnect any external devices.
3. Dust the monitor by wiping the screen and the cabinet with a soft, clean antistatic cloth.
4. For more difficult cleaning situations, use a 50/50 mix of water and isopropyl alcohol.



IMPORTANT: Do not use cleaners that contain any petroleum-based materials such as benzene, thinner, or any volatile substance to clean the monitor screen or cabinet. These chemicals may damage the monitor.

IMPORTANT: Spray the cleaner onto a cloth and use the damp cloth to gently wipe the screen surface. Never spray the cleaner directly on the screen surface. It may run behind the bezel and damage the electronics. The cloth should be moist, but not wet. Water dripping into the ventilation openings or other points of entry can cause damage to the monitor. Allow the monitor to air-dry before use.

Shipping the monitor

Keep the original packing box in a storage area. You may need it later if you ship the monitor or move.

A Technical specifications



NOTE: All specifications represent the typical specifications provided by HP's component manufacturers; actual performance may vary either higher or lower.

For the latest specifications or additional specifications on this product, go to <http://www.hp.com/go/quickspecs/> and search for your specific monitor model to find the model-specific QuickSpecs.

Table A-1 Model specifications

| Specification | Measurement | |
|-----------------------------------|---|----------------------------|
| Display, wide-screen | 68.58 cm | 27.0 in |
| Type | IPS | |
| Viewable image size | 68.58 cm diagonal | 27.0 in diagonal |
| Maximum weight (unpacked) | 7.35 kg | 16.17 lbs |
| Dimensions (include base) | | |
| Height | 51.12 cm | 20.12 in |
| Depth | 21.64 cm | 8.52 in |
| Width | 61.12 cm | 24.06 in |
| Tilt | -4° to 20° | |
| Environmental requirements | | |
| Operating temperature | 5°C to 35°C | 41°F to 95°F |
| Storage temperature | -34°C to 60°C | -29°F to 140°F |
| Storage humidity | | 5% to 95% (noncondensing) |
| Operating humidity | | 20% to 80% (noncondensing) |
| Power source | 100 V ac – 240 V ac 50/60 Hz | |
| Input terminal | One HDMI 2.0 connector, one DisplayPort connector, one audio-out (headphone) jack | |

Preset display resolutions

The following display resolutions are the most commonly used modes and are set as factory defaults. This monitor automatically recognizes these preset modes, and they will appear properly sized and centered on the screen.

Table A-2 Preset display resolutions

| Preset | Pixel format | Horz freq (kHz) | Vert freq (Hz) |
|--------|---------------|-----------------|----------------|
| 1 | 640 × 480 | 31.47 | 59.94 |
| 2 | 640 × 480 | 37.50 | 75.00 |
| 3 | 720 × 400 | 31.47 | 70.08 |
| 4 | 800 × 600 | 37.88 | 60.32 |
| 5 | 800 × 600 | 46.88 | 75.00 |
| 6 | 1024 × 768 | 48.36 | 60.00 |
| 7 | 1024 × 768 | 60.24 | 74.93 |
| 8 | 1024 × 768 | 60.02 | 75.03 |
| 9 | 1280 × 720 | 44.77 | 59.86 |
| 10 | 1280 × 720 | 56.46 | 74.78 |
| 11 | 1280 × 768-R | 47.40 | 60.00 |
| 12 | 1280 × 800 | 49.702 | 59.81 |
| 13 | 1280 × 800 | 62.795 | 74.934 |
| 14 | 1280 × 1024 | 63.98 | 60.02 |
| 15 | 1280 × 1024 | 79.98 | 75.02 |
| 16 | 1440 × 900-R | 55.496 | 59.901 |
| 17 | 1440 × 900 | 55.935 | 59.887 |
| 18 | 1440 × 900 | 70.60 | 75.00 |
| 19 | 1600 × 900-R | 60.00 | 60.00 |
| 20 | 1600 × 1200 | 75.00 | 60.00 |
| 21 | 1680 × 1050 | 65.29 | 59.95 |
| 22 | 1680 × 1050 | 82.306 | 75.00 |
| 23 | 1920 × 1080-R | 66.587 | 59.934 |
| 24 | 1920 × 1080 | 67.158 | 59.963 |
| 25 | 1920 × 1080 | 67.50 | 60.00 |
| 26 | 1920 × 1080 | 166.442 | 143.856 |
| 27 | 1920 × 1200-R | 74.04 | 59.95 |
| 28 | 1920 × 1200 | 74.56 | 59.89 |
| 29 | 2048 × 1280-R | 78.918 | 59.922 |

Table A-2 Preset display resolutions (continued)

| Preset | Pixel format | Horz freq (kHz) | Vert freq (Hz) |
|--------|--------------|-----------------|----------------|
| 30 | 2560 × 1080 | 66.636 | 59.978 |
| 31 | 2560 × 1440 | 88.787 | 59.951 |
| 32 | 2560 × 1440 | 104.056 | 69.923 |
| 33 | 2560 × 1440 | 182.817 | 119.88 |
| 34 | 2560 × 1440 | 221.97 | 143.856 |

Energy saver feature

The monitor supports a reduced power state. If the monitor detects the absence of either the horizontal sync signal or the vertical sync signal, it enters the reduced power state. Upon detecting the absence of these signals, the monitor screen turns blank, the backlight turns off, and the power light turns amber. When the monitor is in the reduced power state, the monitor uses 0.5 watts of power. After a brief warm-up period, the monitor returns to its normal operating mode.

See the computer manual for instructions on setting energy saver features (sometimes called power management features).



NOTE: This power saver feature works only when the monitor is connected to a computer that has energy saver features.

By selecting the settings in the monitor's Energy Saver utility, you can also program the monitor to initiate the reduced power state at a predetermined time. When the monitor's Energy Saver utility initiates the reduced power state, the power light blinks amber.

B Accessibility

HP and accessibility

Because HP works to weave diversity, inclusion, and work/life into the fabric of the company, it is reflected in everything HP does. HP strives to create an inclusive environment focused on connecting people to the power of technology throughout the world.

Finding the technology tools you need

Technology can unleash your human potential. Assistive technology removes barriers and helps you create independence at home, at work, and in the community. Assistive technology helps increase, maintain, and improve the functional capabilities of electronic and information technology. For more information, see [Finding the best assistive technology on page 29](#).

The HP commitment

HP is committed to providing products and services that are accessible for people with disabilities. This commitment supports the company's diversity objectives and helps ensure that the benefits of technology are available to all.

The HP accessibility goal is to design, produce, and market products and services that can be effectively used by everyone, including people with disabilities, either on a stand-alone basis or with appropriate assistive devices.

To achieve that goal, this Accessibility Policy establishes seven key objectives to guide HP actions. All HP managers and employees are expected to support these objectives and their implementation in accordance with their roles and responsibilities:

- Raise the level of awareness of accessibility issues within HP, and provide employees with the training they need to design, produce, market, and deliver accessible products and services.
- Develop accessibility guidelines for products and services, and hold product development groups accountable for implementing these guidelines where competitively, technically, and economically feasible.
- Involve people with disabilities in the development of accessibility guidelines and in the design and testing of products and services.
- Document accessibility features, and make information about HP products and services publicly available in an accessible form.
- Establish relationships with leading assistive technology and solution providers.
- Support internal and external research and development that improves assistive technology relevant to HP products and services.
- Support and contribute to industry standards and guidelines for accessibility.

International Association of Accessibility Professionals (IAAP)

IAAP is a not-for-profit association focused on advancing the accessibility profession through networking, education, and certification. The objective is to help accessibility professionals develop and advance their careers and to better enable organizations to integrate accessibility into their products and infrastructure.

As a founding member, HP joined to participate with other organizations to advance the field of accessibility. This commitment supports HP's accessibility goal of designing, producing, and marketing products and services that people with disabilities can effectively use.

IAAP will make the profession strong by globally connecting individuals, students, and organizations to learn from one another. If you are interested in learning more, go to <http://www.accessibilityassociation.org> to join the online community, sign up for newsletters, and learn about membership options.

Finding the best assistive technology

Everyone, including people with disabilities or age-related limitations, should be able to communicate, express themselves, and connect with the world using technology. HP is committed to increasing accessibility awareness within HP and with our customers and partners. Whether it's large fonts that are easy on the eyes, voice recognition that lets you give your hands a rest, or any other assistive technology to help with your specific situation—a variety of assistive technologies make HP products easier to use. How do you choose?

Assessing your needs

Technology can unleash your potential. Assistive technology removes barriers and helps you create independence at home, at work, and in the community. Assistive technology (AT) helps increase, maintain, and improve the functional capabilities of electronic and information technology.

You can choose from many AT products. Your AT assessment should allow you to evaluate several products, answer your questions, and facilitate your selection of the best solution for your situation. You will find that professionals qualified to do AT assessments come from many fields, including those licensed or certified in physical therapy, occupational therapy, speech/language pathology, and other areas of expertise. Others, while not certified or licensed, can also provide evaluation information. You will want to ask about the individual's experience, expertise, and fees to determine if they are appropriate for your needs.

Accessibility for HP products

The following links provide information about accessibility features and assistive technology, if applicable, included in various HP products. These resources will help you select the specific assistive technology features and product(s) most appropriate for your situation.

- [HP Elite x3—Accessibility Options \(Windows 10 Mobile\)](#)
- [HP PCs—Windows 7 Accessibility Options](#)
- [HP PCs—Windows 8 Accessibility Options](#)
- [HP PC's—Windows 10 Accessibility Options](#)
- [HP Slate 7 Tablets—Enabling Accessibility Features on Your HP Tablet \(Android 4.1/Jelly Bean\)](#)
- [HP SlateBook PCs—Enabling Accessibility Features \(Android 4.3, 4.2/Jelly Bean\)](#)
- [HP Chromebook PCs—Enabling Accessibility Features on Your HP Chromebook or Chromebox \(Chrome OS\)](#)
- [HP Shopping—peripherals for HP products](#)

If you need additional support with the accessibility features on your HP product, see [Contacting support on page 32](#).

Additional links to external partners and suppliers that may provide additional assistance:

- [Microsoft Accessibility information \(Windows 7, Windows 8, Windows 10, Microsoft Office\)](#)
- [Google Products accessibility information \(Android, Chrome, Google Apps\)](#)

- [Assistive Technologies sorted by impairment type](#)
- [Assistive Technologies sorted by product type](#)
- [Assistive Technology vendors with product descriptions](#)
- [Assistive Technology Industry Association \(ATIA\)](#)

Standards and legislation

Standards

Section 508 of the Federal Acquisition Regulation (FAR) standards was created by the US Access Board to address access to information and communication technology (ICT) for people with physical, sensory, or cognitive disabilities. The standards contain technical criteria specific to various types of technologies, as well as performance-based requirements which focus on functional capabilities of covered products. Specific criteria cover software applications and operating systems, web-based information and applications, computers, telecommunications products, video and multimedia, and self-contained closed products.

Mandate 376 – EN 301 549

The EN 301 549 standard was created by the European Union within Mandate 376 as the basis for an online toolkit for public procurement of ICT products. The standard specifies the functional accessibility requirements applicable to ICT products and services, together with a description of the test procedures and evaluation methodology for each accessibility requirement.

Web Content Accessibility Guidelines (WCAG)

Web Content Accessibility Guidelines (WCAG) from the W3C's Web Accessibility Initiative (WAI) helps web designers and developers create sites that better meet the needs of people with disabilities or age-related limitations. WCAG advances accessibility across the full range of web content (text, images, audio, and video) and web applications. WCAG can be precisely tested, is easy to understand and use, and allows web developers flexibility for innovation. WCAG 2.0 has also been approved as [ISO/IEC 40500:2012](#).

WCAG specifically addresses barriers to accessing the web experienced by people with visual, auditory, physical, cognitive, and neurological disabilities, and by older web users with accessibility needs. WCAG 2.0 provides characteristics of accessible content:

- **Perceivable** (for instance, by addressing text alternatives for images, captions for audio, adaptability of presentation, and color contrast)
- **Operable** (by addressing keyboard access, color contrast, timing of input, seizure avoidance, and navigability)
- **Understandable** (by addressing readability, predictability, and input assistance)
- **Robust** (for instance, by addressing compatibility with assistive technologies)

Legislation and regulations

Accessibility of IT and information has become an area of increasing legislative importance. The links listed below provide information about key legislation, regulations, and standards.

- [United States](#)
- [Canada](#)
- [Europe](#)

- [United Kingdom](#)
- [Australia](#)
- [Worldwide](#)

Useful accessibility resources and links

The following organizations might be good resources for information about disabilities and age-related limitations.



NOTE: This is not an exhaustive list. These organizations are provided for informational purposes only. HP assumes no responsibility for information or contacts you encounter on the Internet. Listing on this page does not imply endorsement by HP.

Organizations

- American Association of People with Disabilities (AAPD)
- The Association of Assistive Technology Act Programs (ATAP)
- Hearing Loss Association of America (HLAA)
- Information Technology Technical Assistance and Training Center (ITTATC)
- Lighthouse International
- National Association of the Deaf
- National Federation of the Blind
- Rehabilitation Engineering & Assistive Technology Society of North America (RESNA)
- Telecommunications for the Deaf and Hard of Hearing, Inc. (TDI)
- W3C Web Accessibility Initiative (WAI)

Educational institutions

- California State University, Northridge, Center on Disabilities (CSUN)
- University of Wisconsin - Madison, Trace Center
- University of Minnesota computer accommodations program

Other disability resources

- ADA (Americans with Disabilities Act) Technical Assistance Program
- ILO Global Business and Disability network
- EnableMart
- European Disability Forum
- Job Accommodation Network
- Microsoft Enable

HP links

[Our contact webform](#)

[HP comfort and safety guide](#)

[HP public sector sales](#)

Contacting support



NOTE: Support is in English only.

- Customers who are deaf or hard of hearing who have questions about technical support or accessibility of HP products:
 - Use TRS/VRS/WebCapTel to call (877) 656-7058 Monday through Friday, 6 a.m. to 9 p.m. Mountain Time.
- Customers with other disabilities or age-related limitations who have questions about technical support or accessibility of HP products, choose one of the following options:
 - Call (888) 259-5707 Monday through Friday, 6 a.m. to 9 p.m. Mountain Time.
 - Complete the [Contact form for people with disabilities or age-related limitations](#).