

5PX 1000 RT2U
5PX 1500 RT2U
5PX 2200 RT2U
5PX 3000 RT2U
5PX 3000 RT3U
5PX EBM 48V RT2U
5PX EBM 72V RT2U
5PX EBM 72V RT3U

Installation and user manual

Copyright © 2010 EATON
All rights reserved.

Service and support:
Call your local service representative

IMPORTANT SAFETY INSTRUCTIONS

SAVE THESE INSTRUCTIONS. This manual contains important instructions that should be followed during installation and maintenance of the UPS and batteries.

The 5PX models that are covered in this manual are intended for installation in an environment within 0 to 40°C, free of conductive contaminant.

This equipment has been tested and found to comply with the limits for a Class A digital device, pursuant to Part 15 of the FCC Rules. These limits are designed to provide reasonable protection against harmful interference when the equipment is operated in a commercial environment. This equipment generates, uses, and can radiate radio frequency energy and, if not installed and used in accordance with the instruction manual, may cause harmful interference to radio communications. Operation of this equipment in a residential area is likely to cause harmful interference in which case the user will be required to correct the interference at his own expense.

Certification Standards

- UPS directives: UL 1778 4th edition (UL listed).
- Performance: IEC 62040-3: 2001.
- Radiated emission: FCC CFR 47 part 15 subpart B, Class A.
- Surges withstand ability: IEEE ANSI C62.41 Category A2 (UL Listed).

Special Symbols

The following are examples of symbols used on the UPS or accessories to alert you to important information:



RISK OF ELECTRIC SHOCK - Observe the warning associated with the risk of electric shock symbol.



Important instructions that must always be followed.



Do not discard the UPS or the UPS batteries in the trash. This product contains sealed lead acid batteries and must be disposed as it's explain in this manual. For more information, contact your local recycling/reuse or hazardous waste center.



This symbol indicates that you should not discard waste electrical or electronic equipment (WEEE) in the trash. For proper disposal, contact your local recycling/reuse or hazardous waste center.



Information, advice, help.

Safety of Persons

- The system has its own power source (the battery). Consequently, the power outlets may be energized even if the systems is disconnected from the AC power source.
- Dangerous voltage levels are present within the system. It should be opened exclusively by qualified service personnel.
- The system must be properly grounded.
- The battery supplied with the system contains small amounts of toxic materials.
To avoid accidents, the directives listed below must be observed:
 - never burn the battery (risk of explosion),
 - do not attempt to open the battery (the electrolyte is dangerous for the eyes and skin),
 - comply with all applicable regulations for the disposal of the battery,
 - batteries constitute a danger (electrical shock, burns).The short-circuit current may be very high.

Precautions must be taken for all handling:

- remove watches, rings, bracelets and any other metal objects, use tools with insulated handles,
- do not lay tools or metal parts on top of batteries.

Product Safety

- The UPS connection instructions and operation described in the manual must be followed in the indicated order.
- A protection circuit breaker must be installed upstream and be easily accessible.
The system can be disconnected from the AC power source by opening this circuit breaker.
- Check that the indications on the rating plate correspond to your AC powered system and to the actual electrical consumption of all the equipment to be connected to the system.
- Never install the system near liquids or in an excessively damp environment.
- Never let a foreign body penetrate inside the system.
- Never block the ventilation grates of the system.
- Never expose the system to direct sunlight or source of heat.
- If the system must be stored prior to installation, storage must be in a dry place.
- The admissible storage temperature range is -15 °C to +50 °C.

Special Precautions

- All handling operations will require at least two people (unpacking, installation in rack system).
- Before and after the installation, if the UPS remains de-energized for a long period, the UPS must be energized for a period of 24 hours, at least once every 6 months (for a normal storage temperature less than 25 °C). This charges the battery, thus avoiding possible irreversible damage.
- During the replacement of the Battery Module, it is imperative to use the same type and number of element as the original Battery Module provided with the UPS to maintain an identical level of performance and safety. In case of doubt, don't hesitate to contact your EATON representative.

1. Introduction.....	6
1.1 Environmental protection.....	6
2. Presentation.....	7
2.1 Standard installations.....	7
2.2 Rear Panels.....	8
2.3 Control panel.....	9
2.4 LCD description.....	10
2.5 Display functions.....	11
2.6 User settings.....	11
3. Installation.....	13
3.1 Unpacking and contents check.....	13
3.2 Battery module connection.....	14
3.3 Tower installation.....	15
3.4 Rack installation.....	15
3.5 Communication ports.....	16
3.6 Connection with a FlexPDU (Power Distribution Unit) module (optional).....	17
3.7 Connection with a HotSwap MBP module (optional).....	17
3.8 UPS connection without a FlexPDU or HotSwap MBP module.....	18
4. Operation.....	19
4.1 Start-up and Normal operation.....	19
4.2 Starting the UPS on Battery.....	19
4.3 UPS Shutdown.....	19
4.4 Operation on Battery Power.....	19
4.5 Return of AC Input Power.....	20
4.6 UPS remote control functions.....	20
5. Maintenance.....	21
5.1 Troubleshooting.....	21
5.2 Battery-module replacement.....	22
5.3 Maintenance on a UPS equipped with the HotSwap MBP module.....	23
6. Appendices.....	24
6.1 Technical specifications.....	24
6.2 Glossary.....	25

1. Introduction

Thank you for selecting an EATON product to protect your electrical equipment.

The 5PX range has been designed with the utmost care.

We recommend that you take the time to read this manual to take full advantage of the many features of your UPS (Uninterruptible Power System).

Before installing your 5PX, please read the booklet presenting the safety instructions. Then follow the indications in this manual.

To discover the entire range of EATON products and the options available for the 5PX range, we invite you to visit our web site at www.eaton.com/powerquality or contact your EATON representative.

1.1 Environmental protection

EATON has implemented an environmental-protection policy. Products are developed according to an eco-design approach.

Substances

This product does not contain CFCs, HCFCs or asbestos.

Packing

To improve waste treatment and facilitate recycling, separate the various packing components.

- The cardboard we use comprises over 50% of recycled cardboard.
- Sacks and bags are made of polyethylene.
- Packing materials are recyclable and bear the appropriate identification symbol



Materials	Abbreviations	Number in the symbols 
Polyethylene terephthalat	PET	01
High-density polyethylene	HDPE	02
Polyvinyl chloride	PVC	03
Low-density polyethylene	LDPE	04
Polypropylene	PP	05
Polystyrene	PS	06

Follow all local regulations for the disposal of packing materials.

End of life

EATON will process products at the end of their service life in compliance with local regulations. EATON works with companies in charge of collecting and eliminating our products at the end of their service life.

Product

The product is made up of recyclable materials.

Dismantling and destruction must take place in compliance with all local regulations concerning waste. At the end of its service life, the product must be transported to a processing center for electrical and electronic waste.

Battery

The product contains lead-acid batteries that must be processed according to applicable local regulations concerning batteries.

The battery may be removed to comply with regulations and in view of correct disposal.

2.1 Standard installations

Tower installation

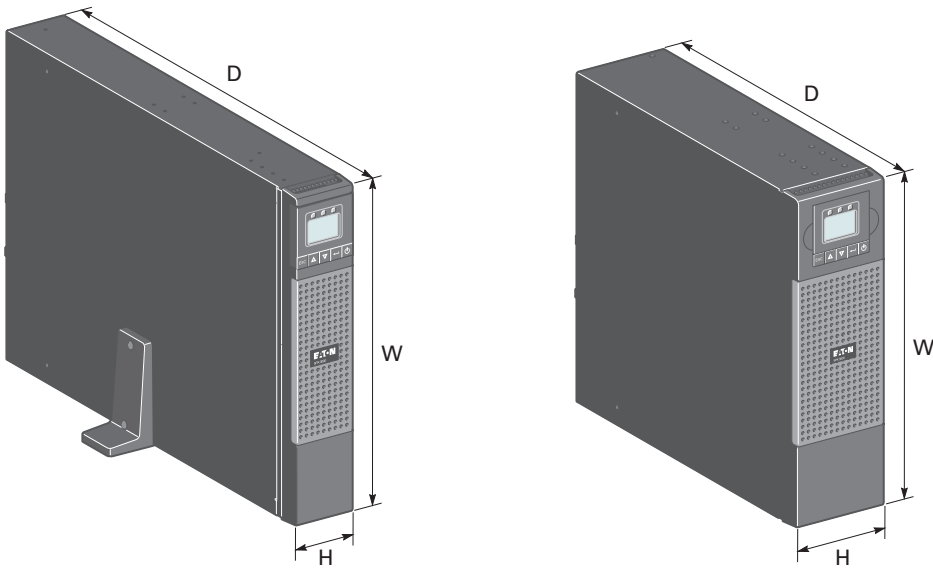

Rack installation

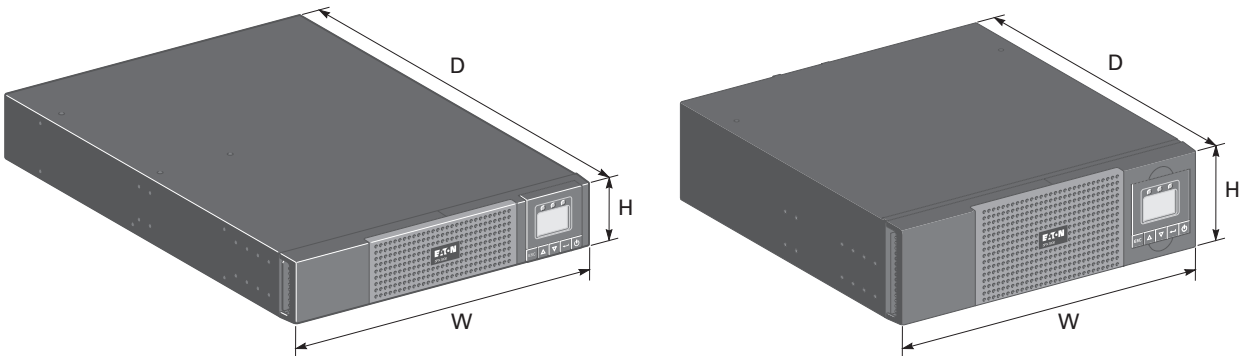

Description	Weights (lb/kg)	Dimensions (inch/mm) D x W x H
5PX 1000 RT2U	61.50 / 27.90	20.6 x 17.4 x 3.4 / 522 x 441.2 x 86.2
5PX 1500 RT2U	64.70 / 29.36	
5PX 2200 RT2U	65.30 / 29.61	
5PX 3000 RT2U	87.20 / 39.54	25.5 x 17.4 x 3.4 / 647 x 441.2 x 86.2
5PX 3000 RT3U	85.60 / 38.80	19.6 x 17.4 x 5.1 / 497 x 441.2 x 130.7
5PX EBM 48V RT2U	72.30 / 32.80	20.6 x 17.4 x 3.4 / 522 x 441.2 x 86.2
5PX EBM 72V RT2U	102.3 / 46.39	25.5 x 17.4 x 3.4 / 647 x 441.2 x 86.2
5PX EBM 72V RT3U	97.6 / 44.26	19.6 x 17.4 x 5.1 / 497 x 441.2 x 130.7

2. Presentation

2.2 Rear panels

5PX 1000 / 1500

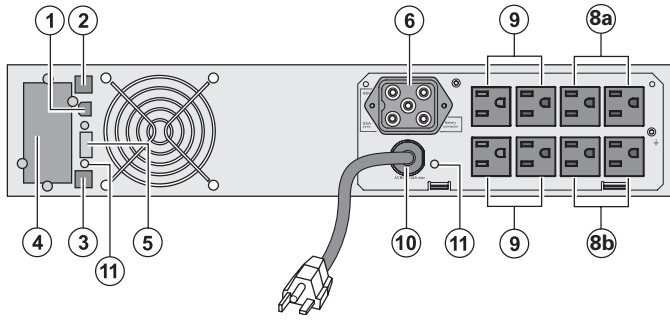

5PX 2200

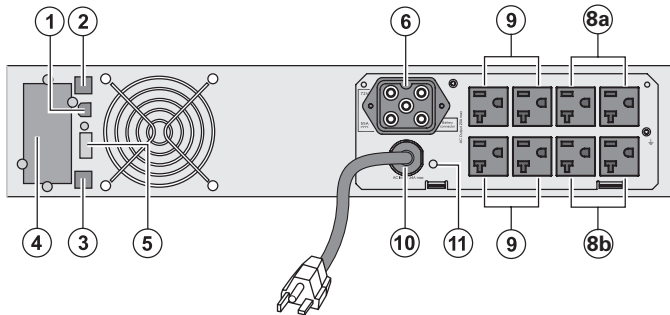

5PX 3000

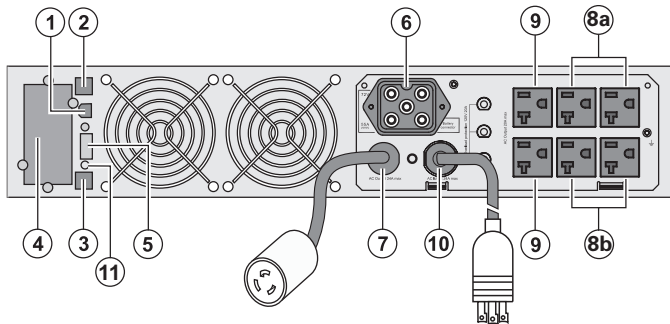

5PX EBM (optional battery module)

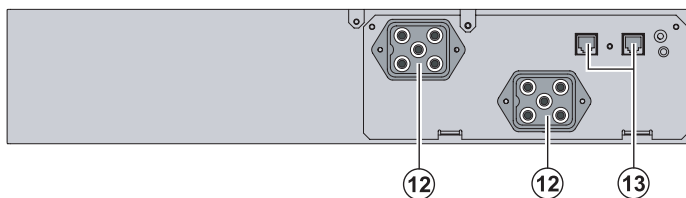

- ① USB communication port
- ② RS232 communication port
- ③ Connector for automatic recognition of an additional battery module
- ④ Slot for optional communication card
- ⑤ Connector for ROO (remote ON/OFF) or RPO (Remote Power OFF) control
- ⑥ Connector for additional battery module
- ⑦ 30A outlet (L5-30R) for connection of equipment (for 5PX 3000 only)
- ⑧a Group 1: 2 programmable outlets for connection of equipment
- ⑧b Group 2: 2 programmable outlets for connection of equipment
- ⑨ Primary Group: outlets for connection of critical equipment
- ⑩ Attached 8 ft. input power cord for AC-power source
5-15P for 1000 / 1500
5-20P for 2200
L5-30P for 3000
- ⑪ LED indicating site wiring fault (SWF) alarm



- ⑫ Connectors for battery modules (to the UPS or to the other battery modules)
- ⑬ Connectors for automatic recognition of battery modules

2.3 Control panel

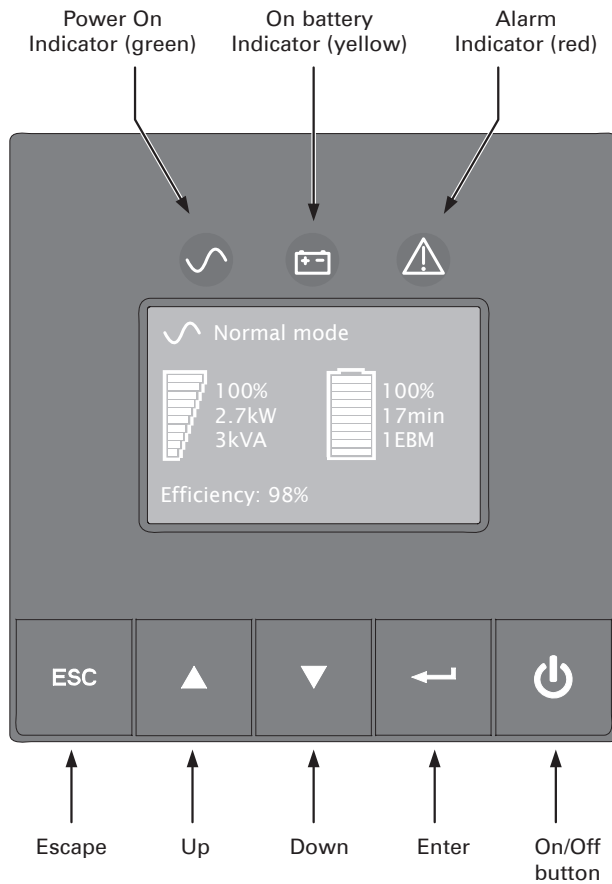
The UPS has a five-button graphical LCD. It provides useful information about the UPS itself, load status, events, measurements and settings.



The following table shows the indicator status and description:

Indicator	Status	Description
 Green	On	The UPS is operating normally.
 Yellow	On	The UPS is on battery mode.
	Flashing	The battery voltage is below the warning level.
 Red	On	The UPS has an active alarm or fault. See troubleshooting on page 21 for additional information.

2. Presentation

2.4 LCD description





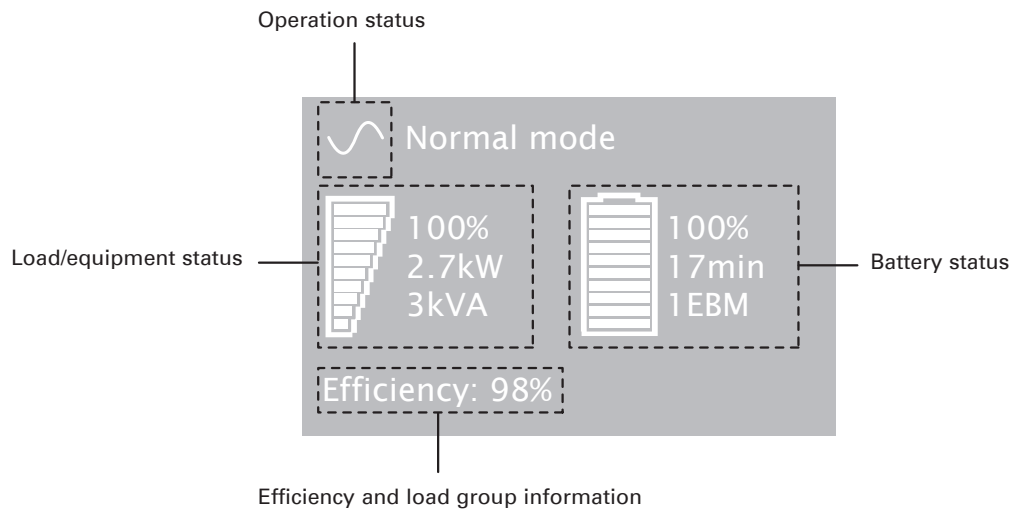

After 5 minutes of inactivity, the LCD displays the screen saver.

The LCD backlight automatically dims after 10 minutes of inactivity. Press any button to restore the screen.



The following table describes the status information provided by the UPS

Note: If other indicator appears, see troubleshooting on page 21 for additional information.

Operation status	Possible cause	Action
Standby mode 	The UPS is OFF, waiting for start-up command from user	Equipment is not powered until  button is pressed.
Normal mode 	The UPS is operating normally.	The UPS is powering and protecting the equipment.
In AVR mode  Load protected LED is ON No beep	The UPS is operating normally but the utility voltage is outside normal mode thresholds.	The UPS is powering the equipment through a Automatic Voltage Regulation device. The equipment is still normally protected.
On Battery  Battery LED is on 1 beep every 10 seconds	A utility failure has occurred and the UPS is in Battery mode.	The UPS is powering the equipment with the battery power. Prepare your equipment for shutdown.
End of backup time  Battery LED is blinking 1 beep every 3 seconds	The UPS is in battery mode and the battery is running low.	This warning is approximate, and the actual time to shutdown may vary significantly. Depending on the UPS Load and number of Extended Battery modules (EBMs), the "Battery Low" warning may occur before the battery reaches 25 % capacity.

2.5 Display functions

Press the Enter (↵) button to activate the menu options. Use the two middle buttons (▲ and ▼) to scroll through the menu structure. Press the Enter (↵) button to select an option. Press the ESC button to cancel or return to the previous menu.

Menu map for Display Functions.

Main menu	Submenu	Display information or Menu function
Measurements		Load W VA / Load A pf / Output V Hz / Input V Hz / Battery V min / Efficiency / Power usage
Control	Load Segments	Group 1: ON / OFF Group 2: ON / OFF These commands overrule user settings for load segments.
	Start battery test	Starts a manual battery test
	Reset fault state	Clears active fault (UPS restart required)
	Restore factory settings	Returns all settings to original values
	Reset power usage	Clears power usage measurements
Settings	Local settings	Sets product general parameters
	Input / output settings	Sets Input and output parameters
	ON / OFF settings	Sets ON / OFF conditions
	Battery settings	Sets battery configuration
Fault log		Displays event log or alarms
Identification		UPS Type / Part Number / Serial Number / Firmware release / Com card address

2.6 User settings

The following table displays the options that can be changed by the user.

	Description	Available settings	Default settings
Local settings	Language	[English] [French] [German] [Italian] [Portuguese] [Spanish] [Russian] Menus, status, notices and alarms, UPS fault, Event Log data and settings are in all supported languages.	English User selectable when UPS is powered for the first time.
	LCD settings	Authorizes to modify LCD screen brightness and contrast to be adapted to room light conditions.	
	Audible alarm	[Yes] [No] Authorizes to enable or disable the buzzer if an alarm occurs.	Yes
In/Out settings	Output voltage	Low voltage: [100 V] [120 V] [125 V] High voltage: [200 V] [208 V] [220 V] [230 V] [240 V]	Low Voltage model: 110 V, High Voltage model: 230 V, User selectable when UPS is powered for the first time.
	Input thresholds	[Normal mode] [Extended mode] Extended mode authorizes lower input voltage (70 V) without transferring to battery. This can be used if the load can withstand low voltage supply.	Normal mode
	Sensitivity	[High] [Low] High: for sensitive equipment, UPS will easily transfer to battery when utility conditions are becoming bad. Low: for equipment that can withstand bad utility conditions, in that case, the UPS will not transfer to battery.	High
	Load segments - Auto start delay	[No Delay] [1 s] [2 s]...[65354 s] The equipment are powered on with the specified delay relative to the primary group.	Group 1: 3 s Group 2: 6 s

2. Presentation

	Description	Available settings	Default settings
In/Out settings	Load segments - Auto shutdown delay	[Disable] [0s] [1 s] [2 s]...[65354 s] During a power outage, authorizes UPS to turn off power to equipment connected to Group 1 and/or Group 2 outlets. This feature allows the shedding of non-critical loads in order to conserve battery power for critical loads connected to the Primary group.	Group 1: Disable Group 2: Disable
	Overload prealarm	[5 %] [10 %] [15 %] [20 %] ... [100 %] [105 %] Sets critical percentage of load where alarm overload alarm occurs.	[105 %]
ON/OFF settings	Cold start	[Disable] [Enable] Authorizes the product to start on battery power.	Enable
	Forced reboot	[Disable] [Enable] If mains recover during a shutdown sequence: If set to Enable, shutdown sequence will complete and wait 10 seconds prior to restart, If set to Disable, shutdown sequence will not complete and restart will occur immediately.	Enable
	Auto restart	[Disable] [Enable] Authorizes the product to restart automatically when mains recovers after a complete battery discharge.	Enable
	Energy saving	[Disable] [Enable] If Enable, UPS will shutdown after 5 min. of back-up time, if no load is detected on the output.	Disable
	Sleep mode	[Disable] [Enable] If disable, LCD and communication will turn OFF immediately after UPS is OFF. If enable, LCD and communication stays ON 1h30 min after UPS is OFF.	Disable
	Remote command	[Disable] [Enable] If enable, shutdown or restart commands from software are authorised.	Enable
Battery settings	Automatic battery test	[No test] [Every day] [Every week] [Every month] Available only if battery charge mode is set to constant charge.	Every week (in constant charge) otherwise following ABM
	Low battery warning	[10 %] [20 %] [30 %] [40 %] [50 %] [60 %] [70 %] [80 %] [90 %] The alarm triggers when the set percentage of battery capacity is reached during a back-up time.	20 %
	Restart battery level	[10 %] [20 %] [30 %] [40 %] [50 %] [60 %] [70 %] [80 %] [90 %] [100 %] If set, automatic restart will occur only when percentage of battery charge is reached.	0 %
	Battery charge mode	[ABM cycling] [Constant charge]	ABM cycling
	EBM number setting	[0] [1] [2] [3] [4] Using standard EBM, UPS detects automatically the amount of EBM connected.	EBM automatic detection, otherwise 0
	Deep discharge protection	[Yes] [No] If set to Yes, the UPS automatically prevents battery from deep discharge by adapting end of back-up time voltage threshold.	Yes

3.1 Unpacking and contents check

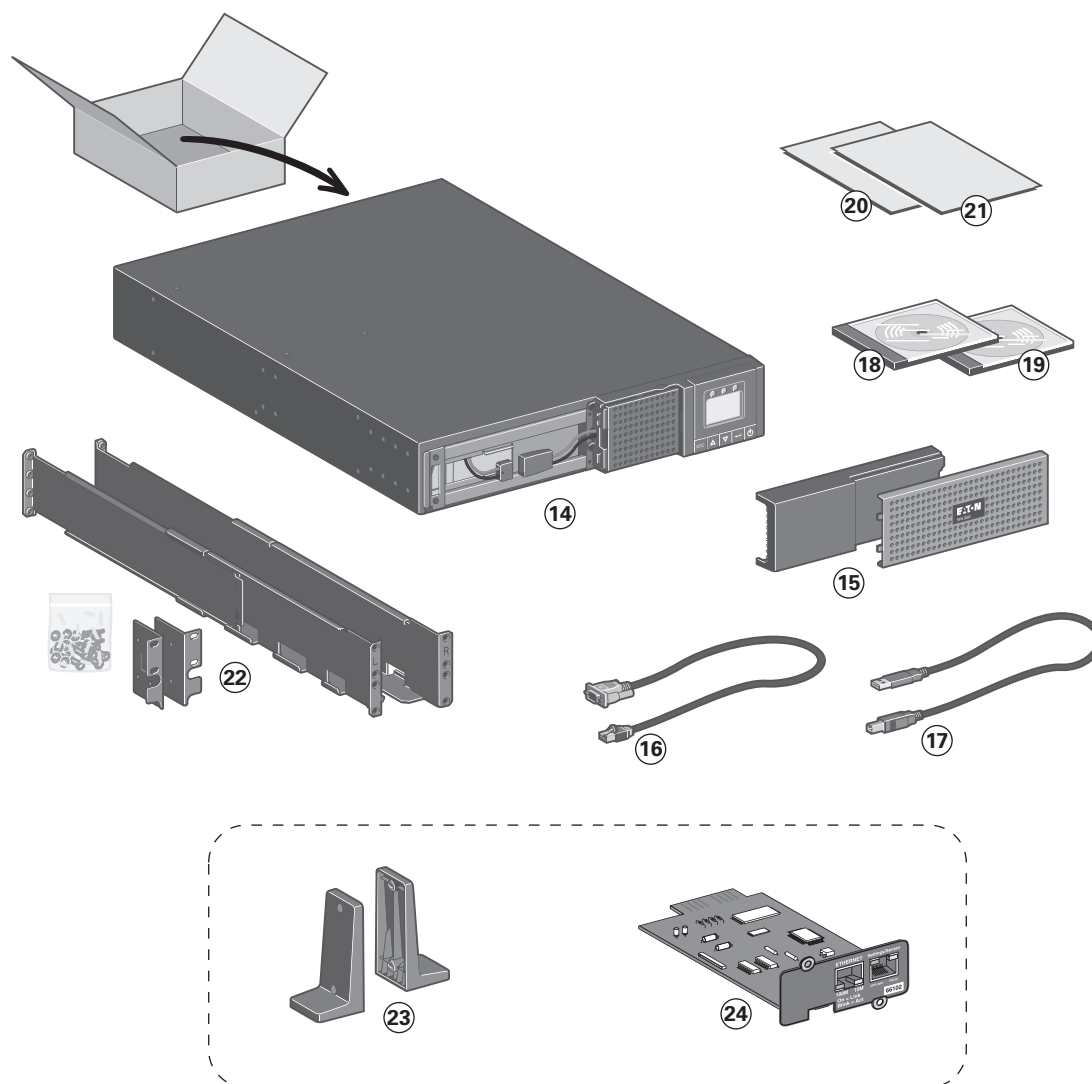

- ⑭ 5PX
- ⑮ Front panel parts
- ⑯ RS232 communication cable
- ⑰ USB communication cable
- ⑱ Software CD-ROM
- ⑲ Manual CD-ROM
- ⑳ Safety instructions
- ㉑ Quick start
- ㉒ Mounting kit for 19-inch bays
- ㉓ 2 supports for the upright position (Rack/Tower 2U version only)
- ㉔ NMC communication card (optional)



Packing materials must be disposed of in compliance with all local regulations concerning waste. Recycling symbols are printed on the packing materials to facilitate sorting.

3. Installation

3.2 Battery module connection

Caution: Before starting the UPS, please connect the internal battery.

Note: A small amount of arcing may occur when connecting the batteries.
This is normal and does not damage the UPS or present any safety concern.

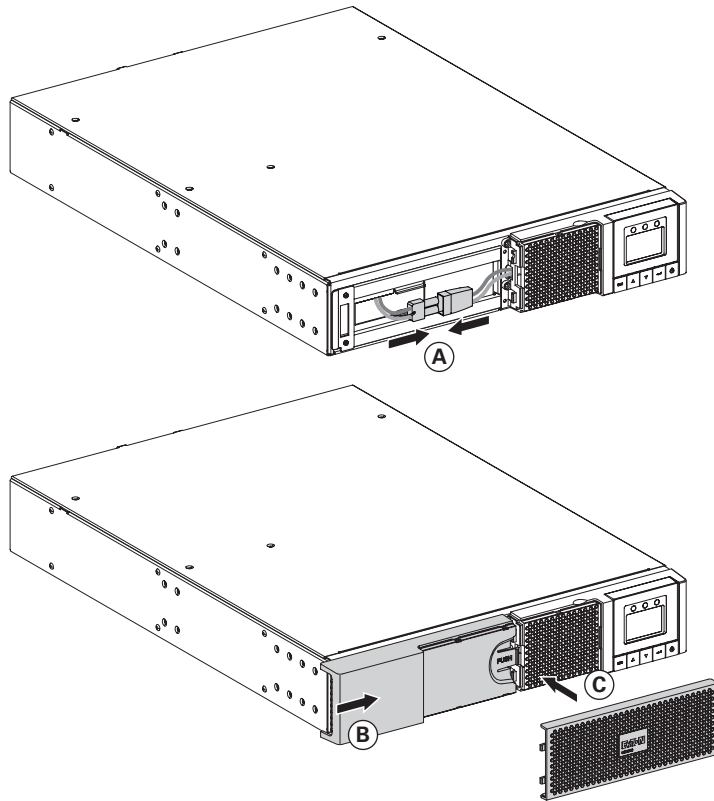

Ⓐ Connect the battery module (never pull on the wires).

Ⓑ Attach the left-hand side of the front panel by sliding it then by locking the push button.

Ⓒ Attach the center panel.

3.3 Tower installation

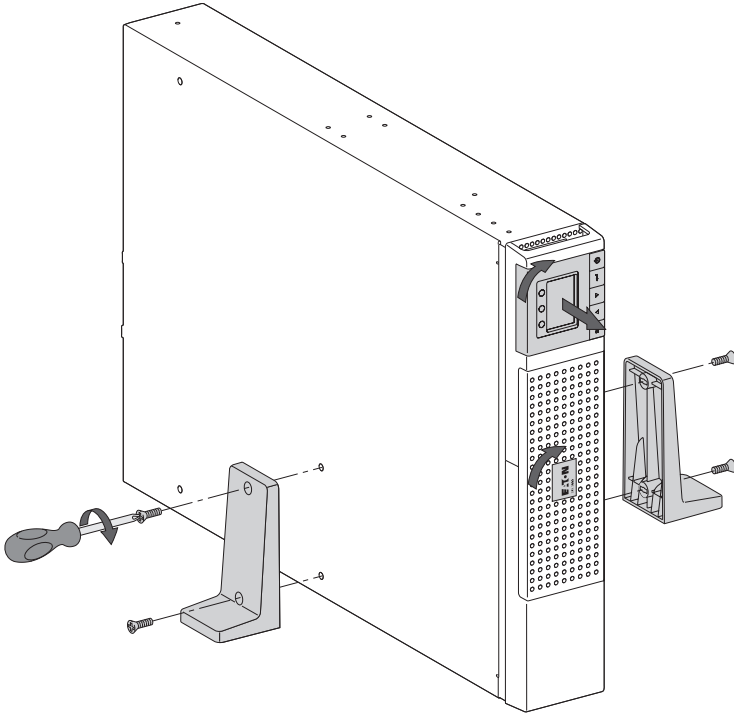

Note: The two supports for the tower position are used on the RT 2U version only.

3.4 Rack installation

Follow steps 1 to 4 for module mounting on the rails.

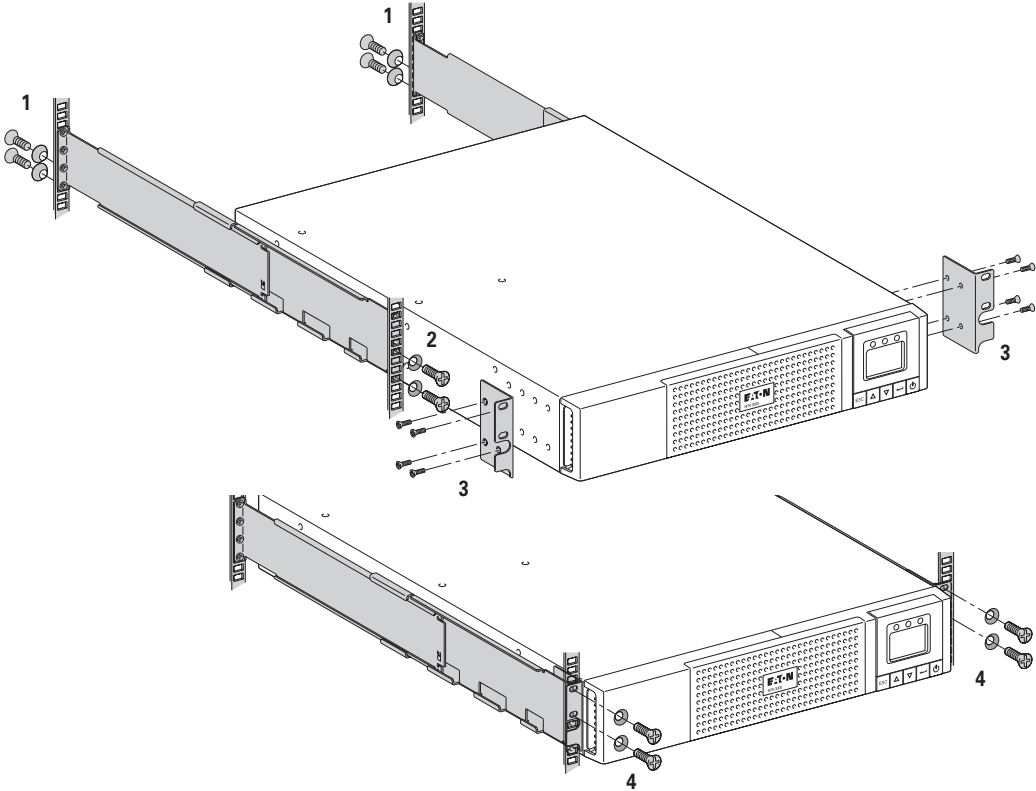

The rails and necessary hardware are supplied by EATON.

3. Installation

3.5 Communication ports

Connection of RS232 or USB communication port (optional)

The RS232 and USB communication ports cannot operate simultaneously.

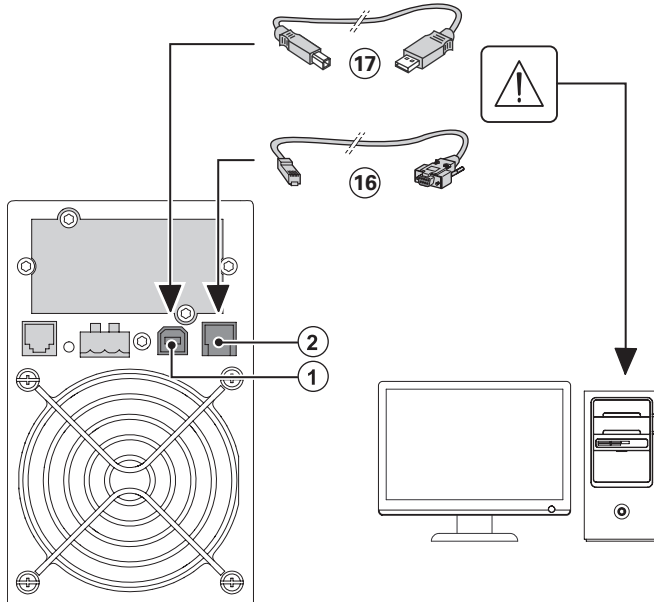

1. Connect the RS232 (16) or USB (17) communication cable to the serial or USB port on the computer equipment.
2. Connect the other end of the communication cable (16) or (17) to the USB (1) or RS232 (2) communication port on the UPS.

The **UPS** can now communicate with EATON power management software.

Installation of the communication cards (optional, standard on the Netpack versions)

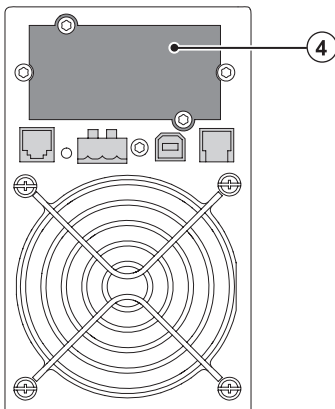

It is not necessary to shutdown the UPS before installing a communication card.

1. Remove the slot cover (4) secured by screws.
2. Insert the communication card in the slot.
3. Secure the slot cover with the 2 screws.

Characteristics of the contact communication port (optional)

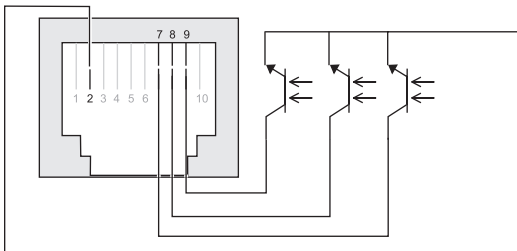

- Pins 1, 3, 4, 5, 6, 10: not used
- Pin 2: common (user)
- Pin 7: low battery
- Pin 8: operation on battery power
- Pin 9: UPS ON, equipment supplied

n.o.: normally open contact

When a signal is activated, the contact is closed between the common (pin 2) and the pin for the corresponding signal.

Contact characteristics (optocoupler)

- Voltage: 48 V DC max
- Current: 25 mA max
- Power: 1.2 W

3.6 Connection with a FlexPDU (Power Distribution Unit) module (optional)

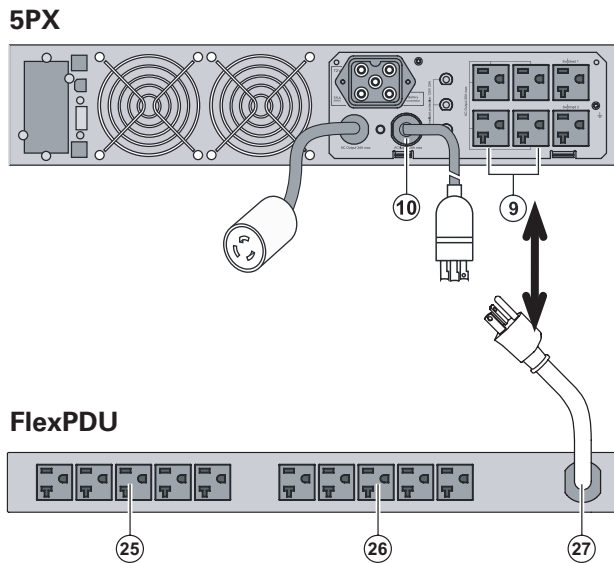

1. Connect the UPS powercord (10) to the AC-power source.
2. Connect the input cord of the **FlexPDU** module (27) to one of the UPS outlets (9). The cable and the connectors are marked in red.
3. Connect the equipment to the outlets (25) and (26) on the **FlexPDU** module. These outlets differ, depending on the version of the **FlexPDU** module.

3.7 Connection with a HotSwap MBP module (optional)

The **HotSwap** MBP module makes it possible to service or even replace the UPS without affecting the connected loads (**HotSwap** function).

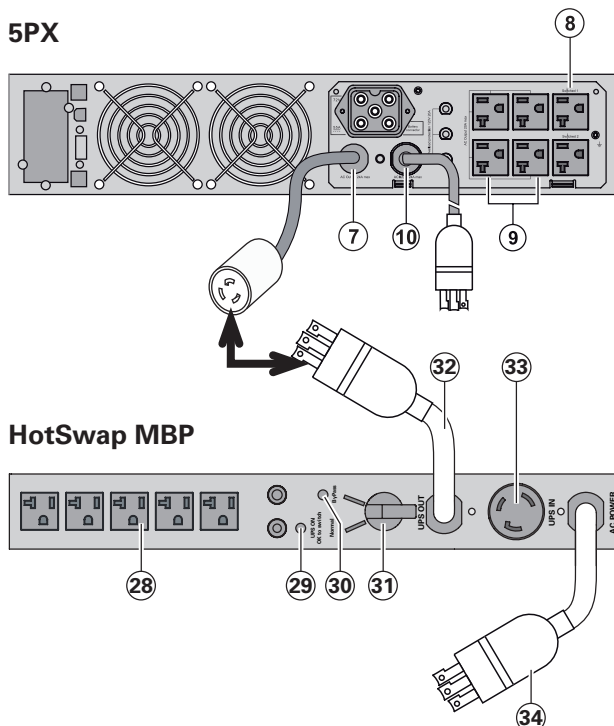

1. Connect the input socket (34) on the **HotSwap MBP** module to the AC-power source.
2. Connect the UPS input socket (10) to the "UPS Input" (33) of the **HotSwap MBP** module. This cord and the receptacle are marked blue.
3. Connect the UPS outlet (7) to the "UPS Output" (32) of the **HotSwap MBP** module. This cord and the outlet are marked red.
4. Connect the equipment to the outlets (28) on the **HotSwap MBP** module.

These outlets differ, depending on the version of the **HotSwap MBP** module.

Caution: Do not use UPS outlets (8) and (9) to supply equipment because use of switch (31) on the **HotSwap MBP** module would cut supply to the equipment.



3. Installation

HotSwap MBP module operation

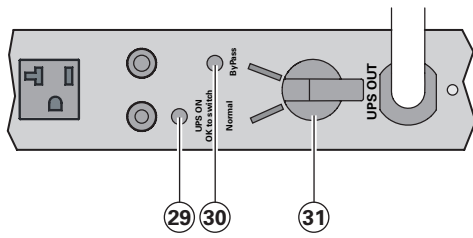

The HotSwap MBP module has a rotary switch (31) with two positions:

Normal the load is supplied by the UPS, LED (29) is on.

Bypass the load is supplied directly by the AC-power source. LED (30) is on.

UPS start-up with the HotSwap MBP module

1. Check that the UPS is correctly connected to the **HotSwap MBP** module.
 2. Set switch (31) to Normal position.
 3. Start the UPS by pressing the ON/OFF button  on the UPS control panel. The load is supplied by the UPS.
- LED (29) "UPS ON - OK to switch" on the **HotSwap MBP** module goes ON.

HotSwap MBP module test

1. Set switch (31) to Bypass position and check that the load is still supplied.
2. Set switch (31) back to Normal position.

3.8 UPS connection without a FlexPDU or HotSwap MBP module



Check that the indications on the name plate located on the back of the UPS correspond to the AC-power source and the true electrical consumption of the total load.

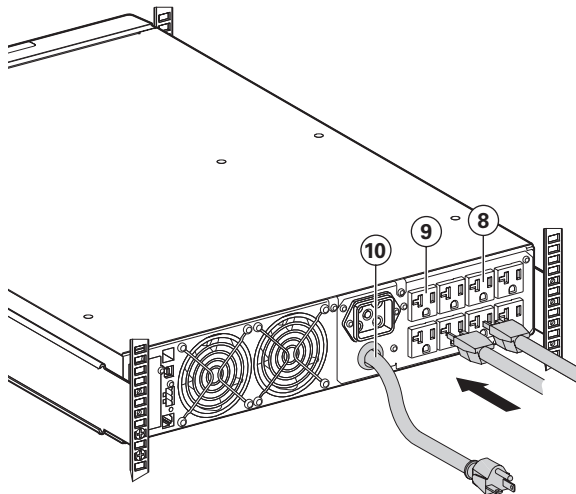

1. **5PX**: connect the UPS input plug (10) to the AC-power source.

2. Connect the loads to the UPS. It is preferable to connect the critical loads to the 'Primary' outlet group shown as (9) and the non-critical loads to either the Group 1 or Group 2 outlets shown as (8). Group 1 and Group 2 outlets can be programmed to shed loads as desired. For the **5PX 3000** models, connect any high-power device to the 30 A outlet (7).

3. To program shutdown of outlets (8) during operation on battery power to optimize the available backup time, please check the in/out settings.







Note: The UPS charges the battery as soon as it is connected to the AC-power source, even if  button is not pressed.

Once the UPS is connected to the AC-power source, eight hours of charging is required before the battery can supply the rated backup time.

4.1 Start-up and Normal operation

To start the UPS:

1. Verify that the UPS power cord is plugged in.
2. The UPS front panel display illuminates and shows EATON logo.
3. Verify that the UPS status screen shows , press  to start.
4. Press the  button on the UPS front panel for at least 2 seconds.
The UPS front panel display changes status to "UPS starting...".
5. Check the UPS front panel display for active alarms or notices. Resolve any active alarms before continuing. See "Troubleshooting" on page 21.
If the  indicator is on, do not proceed until all alarms are clear. Check the UPS status from the front panel to view the active alarms. Correct the alarms and restart if necessary.
6. Verify that the  indicator illuminates solid, indicating that the UPS is operating normally and any loads are powered and protected.
The UPS should be in Normal mode.



4.2 Starting the UPS on Battery



Before using this feature, the UPS must have been powered by utility power with output enabled at least once.

Battery start can be disabled. See the "Cold start" setting in "ON/OFF Settings" on page 12.

To start the UPS on battery:

1. Press the  button on the UPS front panel until the UPS front panel display illuminates and shows a status of "UPS starting...".
The UPS cycles through Standby mode to Battery mode. The  indicator illuminates solid.
The UPS supplies power to your equipment.
2. Check the UPS front panel display for active alarms or notices besides the "Battery mode" notice and notices that indicate missing utility power. Resolve any active alarms before continuing. See "Troubleshooting" on page 21.
Check the UPS status from the front panel to view the active alarms. Correct the alarms and restart if necessary.

4.3 UPS Shutdown



To shut down the UPS:

Press the  button on the front panel for three seconds.

The UPS starts to beep and shows a status of "UPS shutting OFF..". The UPS then transfers to Standby mode, and the  indicator turns off.

4.4 Operation on Battery Power

Transfer to battery power



- The connected devices continue to be supplied by the UPS when AC input power is no longer available. The necessary energy is provided by the battery.
- The  and  indicator illuminates solid.
- The audio alarm beeps every ten seconds.



The connected devices are supplied by the battery.

4. Operation

Low-battery warning

- The  and  indicator illuminates solid.
- The audio alarm beeps every three seconds.

 The remaining battery power is low. Shut down all applications on the connected equipment because automatic UPS shutdown is imminent.

End of battery backup time

- LCD displays "End of backup time".
- All the LEDs go OFF.
- The audio alarms stops.

4.5 Return of AC Input Power

Following an outage, the UPS restarts automatically when AC input power returns (unless the restart function has been disabled) and the load is supplied again.

4.6 UPS remote control functions



5PX offers a choice between two remote control functions.

- **RPO: Remote Power Off** allow a remote contact to be used to disconnect all the equipment connected to the UPS. Restarting the UPS requires manual intervention.
- **ROO: Remote ON/OFF** allows remote action of button  to shut down the UPS.

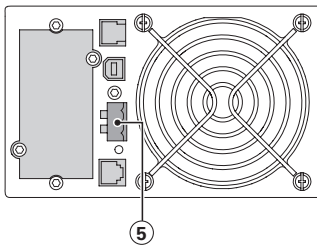
These functions are obtained by opening a contact connected between the appropriate pins of connector  on the rear panel of the UPS (see figures below).



Remote control connection and test

1. Check that the UPS is OFF and disconnected from the AC input source.
2. Remove connector .
3. Connect a normally closed volt-free contact (60 V DC / 30 V AC max., 20 mA max., 0.75 mm² (18 AWG) cable cross-section) between the two pins of connector  (see diagram).

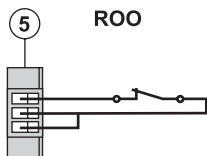

ROO

Contact open: UPS shutdown

Contact closed: UPS start-up (UPS connected to AC power and AC power is available)

Note: The local ON/OFF control using button  overrides the remote-control function.

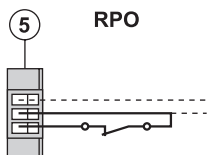

RPO

Contact open: UPS shutdown, LED  goes ON.







To return to normal operation, deactivate the remote external contact and restart the UPS by pressing button .

4. Plug connector  into the back of the UPS.
5. Connect and restart the UPS following the previously described procedures.
6. Activate the external remote shutdown contact to test the function.







Warning: This connector must only be connected to SELV (Safety Extra-Low Voltage) circuits.

5.1 Troubleshooting

Operation status	Possible cause	Action
Batteries disconnected 	The UPS does not recognize the internal batteries	If the condition persists, contact your service representative
	The batteries are disconnected	Verify that all batteries are properly connected. If the condition persists, contact your service representative.
Overload 	Power requirements exceeds the UPS capacity (greater than 105 % of nominal)	Remove some of the equipment from the UPS. The UPS continues to operate, but may shutdown if the load increases. The alarm resets when the condition becomes inactive.
End of battery life 	The end of the battery life is reached.	Contact your service representative for battery replacement.
Event 	An UPS event occurs	
	Example: Remote Power OFF, the RPO contact has been activated to shutdown the UPS and now prevents restart.	Set the contact back to its normal position and press  button to restart.
UPS fault 	An internal failure occurred with the UPS	The UPS does not protect the equipment anymore. Note: The alarm message and the UPS Serial Number, then contact your service representative.

Troubleshooting a UPS equipped with the HotSwap MBP module

	Indication	Diagnostic	Correction
1	The load is no longer supplied when the rotary switch  on the HotSwap MBP module is set to Bypass position.	<ul style="list-style-type: none"> The protected devices are connected to the UPS output instead of to the HotSwap MBP module. The AC-power cord is connected to the UPS input instead of to the HotSwap MBP module. 	Check the wiring between the UPS and the HotSwap MBP module (see section 3.7).
2	The load is no longer supplied when the rotary switch  on the HotSwap MBP module is set to Normal position.	<ul style="list-style-type: none"> The UPS is shut down. The wiring between the UPS and the HotSwap MBP module is incorrect. 	<ul style="list-style-type: none"> Start the UPS. Check the wiring between the UPS and the HotSwap MBP module (see section 3.7).
3	The load is no longer supplied after AC-power fails.	<ul style="list-style-type: none"> The rotary switch  on the HotSwap MBP module is set to Bypass position. The wiring between the UPS and the HotSwap MBP module is incorrect. 	<ul style="list-style-type: none"> Set the rotary switch  on the HotSwap MBP module to Normal position. Check the wiring between the UPS and the HotSwap MBP module (see section 3.7).

5. Maintenance

5.2 Battery-module replacement

Safety recommendations

The battery can cause electrocution and high short-circuit currents. The following safety precautions are required before servicing the battery components:

- remove watches, rings, bracelets and all other metal objects from the hands and arms,
- use tools with an insulated handle.

Battery-module removal

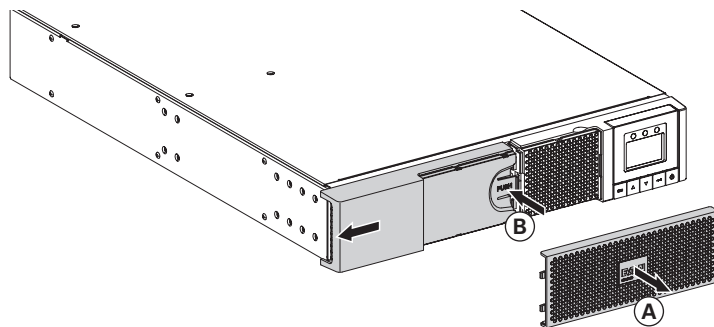

- Ⓐ Remove the middle panel.
- Ⓑ Remove the left-hand side of the front panel by pushing the button and then by sliding the part.

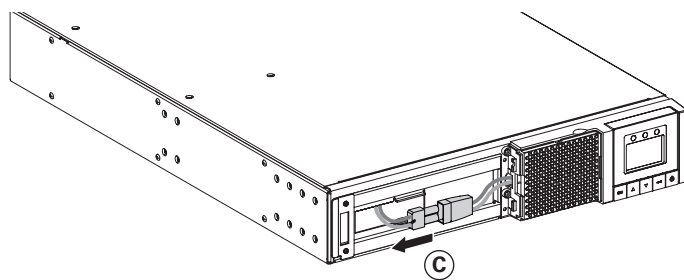

- Ⓒ Disconnect the battery-module by separating the town connectors (never pull on the wires).

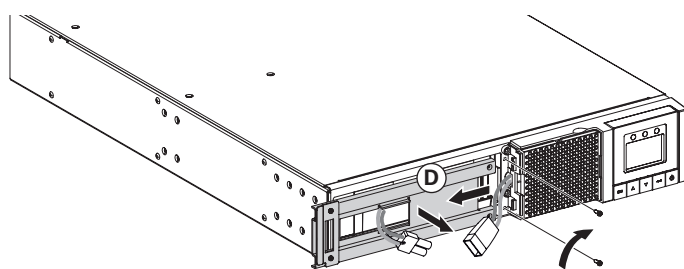

- Ⓓ Remove the metal protection cover in front of the battery (two screws).

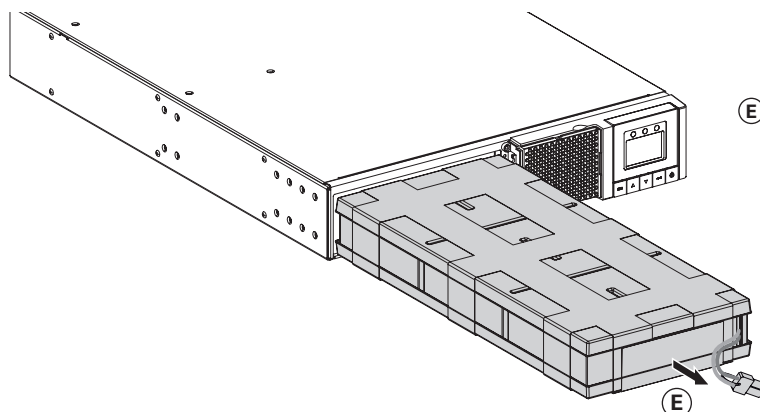

- Ⓔ Pull the plastic tab to remove the battery block and replace it.

Mounting the new battery module

Carry out the above instructions in reverse order.



- To ensure safety and high performance, use only batteries supplied by EATON.
- Take care to firmly press together the two parts of the connector during remounting.

5.3 Maintenance on a UPS equipped with the HotSwap MBP module

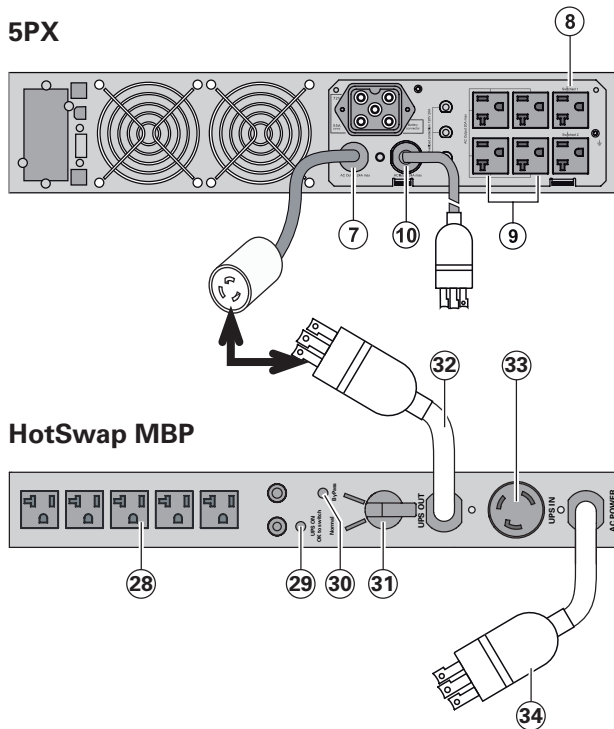

The **HotSwap MBP** module makes it possible to service or even replace the UPS without affecting the connected loads (**HotSwap** function).

Maintenance

1. Set switch **31** to Bypass position.
The red LED on the **HotSwap MBP** module goes ON, indicating that the load is supplied directly with AC input source power.
2. Stop the UPS by pressing the **⏻** button on the UPS control panel.
LED **29** "UPS ON - OK to switch" goes OFF, the UPS can now be disconnected and replaced.

Return to normal operation

1. Check that the UPS is correctly connected to the **HotSwap MBP** module.
2. Start the UPS by pressing the **⏻** button on the UPS control panel.
LED **29** "UPS ON - OK to switch" on the **HotSwap MBP** module goes ON (otherwise, there is a connection error between the **HotSwap MBP** module and the UPS).
3. Set switch **31** to Normal position.
The red LED on the **HotSwap MBP** module goes OFF.

6. Appendices

6.1 Technical specifications

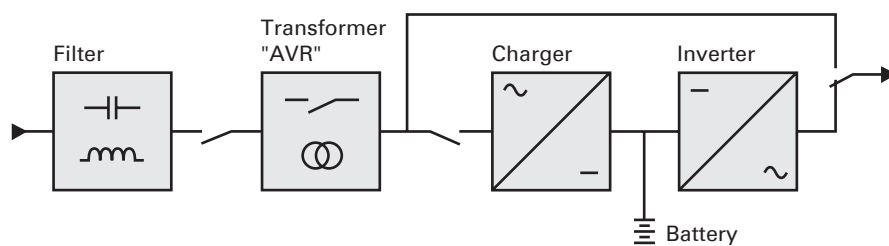

	5PX 1000 RT2U	5PX 1500 RT2U	5PX 2200 RT2U	5PX 3000 RT2U	5PX 3000 RT3U
Output Power	1000 VA 1000 W	1440 VA 1440 W	1950 VA 1920 W	2880 VA - 2700 W	
Output Power Capacity	1000 VA 1000 W	1500 VA 1500 W	2200 VA 1980 W	3000 VA - 2700 W	
AC Input power ● Rated input voltage ● Input voltage range ● input frequency range	Single phase 100-125 V 89 to 151 V ⁽¹⁾ 47 to 70 Hz (50 Hz system), 56.5 to 70 Hz (60 Hz system) ⁽²⁾				
Output on battery power ● Voltage ● Frequency	120 V (-10/+6 %) ⁽³⁾ 50/60 Hz ±0.1 Hz				
Battery (sealed lead acid, maintenance free) ● Standard	4 x 12 V 7.2 Ah	4 x 12 V 9 Ah	6 x 12V 9Ah		
● Additional modules possible (up to 4 EBM)	5PX EBM 48V RT2U ⁽⁴⁾		5PX EBM 72 V RT2U ⁽⁵⁾	5PX EBM 72 V RT3U ⁽⁵⁾	
Environnement ● Operating temperature range ● Storage temperature range ● Relative humidity	0 to 40 °C -15 to +50 °C 20 to 90 % (without condensation)				
● Noise level	< 45 dBA			< 50 dBA	

(1) The high and low thresholds can be adjusted using UPS settings.

(2) Up to 40 Hz in low-sensitivity mode (programmable using UPS settings).

(3) Adjustable to 100 V (17 % derating at 100 V on 1.5 kVA / 3 kVA, 32 % derating at 100 V on 2.2 kVA) 120/125 V.

(4) 5PX EBM 48V RT2U: 2 strings, each 4 x 12 V / 9 Ah.

(5) 5PX EBM 72V RT2U and 5PX EBM 72V RT3U: 2 strings, each 6 x 12 V / 9 Ah.

This product is designed for IT power distribution system.

6.2 Glossary

Backup time	Time during which the load can be supplied by the UPS operating on battery power.
Battery test	Internal UPS test to check battery status.
Cold start	The devices connected to the UPS can be started even if AC input power is not available. The UPS operates on battery power alone.
Deep discharge	Battery discharge beyond the permissible limit, resulting in irreversible damage to the battery.
FlexPDU	Module with UPS outlets for installation in a bay. There are different modules with different types of outlets.
HotSwap MBP	UPS manual-bypass module for maintenance. There are different modules with different types of outlets.
Load	Devices or equipment connected to the UPS output.
Low-battery warning	This is a battery-voltage level indicating that battery power is low and that the user must take action in light of the imminent break in the supply of power to the load.
Programmable outlets	Controllable outlets for automatic load shedding, remote shutdown and sequential restart (personalised using software).
UPS	Uninterruptible Power System.