

# Installation Guide

10/100Mbps Unmanaged Switch

TL-SF1016DS/TL-SF1016

TL-SF1024D/TL-SF1024

TL-SF1048

## COPYRIGHT & TRADEMARKS

Specifications are subject to change without notice. **TP-LINK®** is a registered trademark of TP-LINK TECHNOLOGIES CO., LTD. Other brands and product names are trademarks of their respective holders.

No part of the specifications may be reproduced in any form or by any means or used to make any derivative such as translation, transformation, or adaptation without permission from TP-LINK TECHNOLOGIES CO., LTD. Copyright © 2013 TP-LINK TECHNOLOGIES CO., LTD. All rights reserved.

<http://www.tp-link.com>

## FCC STATEMENT



This equipment has been tested and found to comply with the limits for a Class A digital device, pursuant to part 15 of the FCC Rules. These limits are designed to provide reasonable protection against harmful interference when the equipment is operated in a commercial environment. This equipment generates, uses, and can radiate radio frequency energy and, if not installed and used in accordance with the instruction manual, may cause harmful interference to radio communications. Operation of this equipment in a residential area is likely to cause harmful interference in which case the user will be required to correct the interference at his own expense.

This device complies with part 15 of the FCC Rules. Operation is subject to the following two conditions:

- 1) This device may not cause harmful interference.
- 2) This device must accept any interference received, including interference that may cause undesired operation.

Any changes or modifications not expressly approved by the party responsible for compliance could void the user's authority to operate the equipment.

## CE Mark Warning



This is a Class A product. In a domestic environment, this product may cause radio interference, in which case the user may be required to take adequate measures.

## Related Document

---

This Installation Guide is also available in PDF on our website. To obtain the latest documentation and product information, please visit our official website:

<http://www.tp-link.com>

## About this Installation Guide

---

This Installation Guide describes the hardware characteristics, installation methods and the points that should be attended to during installation. This Installation Guide is structured as follows:

**Chapter 1 Introduction.** This chapter describes the external components of the switch.

**Chapter 2 Installation.** This chapter illustrates how to install the switch.

**Chapter 3 Lightning Protection.** This chapter illustrates how to prevent lightning damage.

**Chapter 4 Connection.** This chapter illustrates how to do the physical connection of the switch.

**Appendix A Troubleshooting.**

**Appendix B Hardware Specifications.**

**Appendix C Technical Support.**

## Audience

---

This Installation Guide is for:

Network Engineer



Network Administrator

## Conventions

---

Due to the similarity in structure of TL-SF1016DS/TL-SF1016/TL-SF1024D/TL-SF1024/TL-SF1048 10/100Mbps Unmanaged Switch series, in this Installation Guide we take TL-SF1016 as an example to illustrate Chapter 2 Installation, Chapter 3 Lightning Protection and Chapter 4 Connection.

This Guide uses the specific formats to highlight special messages. The following table lists the notice icons that are used throughout this guide.

	Remind to be careful. A caution indicates a potential which may result in device damage.
	Remind to take notice. The note contains the helpful information for a better use of the product.

# Contents

---

Chapter 1	Introduction	01
1.1	Product Overview	01
1.2	Features	01
1.3	Appearance	01
Chapter 2	Installation	04
2.1	Package Contents	04
2.2	Safety Precautions	04
2.3	Installation Tools	06
2.4	Product Installation	07
Chapter 3	Lightning Protection	09
3.1	Cabling Reasonably	09
3.2	Connect to Ground	11
3.3	Equipotential Bonding	12
3.4	Use Lightning Arrester	13
Chapter 4	Connection	15
4.1	Ethernet Port	15
4.2	Verify Installation	15
4.3	Power On	15
4.4	Initialization	16
Appendix A	Troubleshooting	16
Appendix B	Hardware Specifications	17
Appendix C	Technical Support	18

# Chapter 1 Introduction

## 1.1 Product Overview

TL-SF1016/TL-SF1016DS/TL-SF1024/TL-SF1024D/TL-SF1048 switch provides 16/24/48 10/100Mbps Auto-Negotiation RJ45 ports. Each port of the TL-SF1016/TL-SF1016DS/TL-SF1024/TL-SF1024D/TL-SF1048 supports auto MDI/MDI-X function, eliminating the need for crossover cables or Uplink ports. The switch is Plug-and-Play and any port can be simply plugged into a server, a hub or a switch, using straight cable or crossover cable.

The TL-SF1016/TL-SF1016DS/TL-SF1024/TL-SF1024D/TL-SF1048 16/24/48-port 10/100Mbps Fast Ethernet Switch provides you with a low-cost, easy-to-use, high-performance, seamless and standard upgrade to improve your old network to a 100Mbps network. It will boost your network performance up to full duplex data transfer.

## 1.2 Features

- Complies with IEEE802.3, IEEE802.3u standards
- 16/24/48 10/100Mbps Auto-Negotiation RJ45 ports supporting Auto- MDI/MDIX
- Supports IEEE802.3X flow control for full-duplex mode and backpressure for half-duplex mode
- LED indicators for monitoring power, link, activity, speed
- Rack-mountable steel case
- Internal power supply

## 1.3 Appearance

### ■ Front Panel

The front panel of The TL-SF1016 is shown as the following figure.

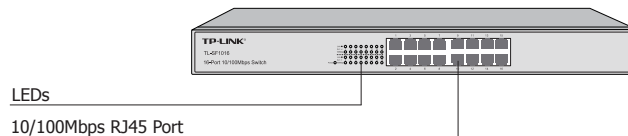

Figure 1-1 Front Panel of TL-SF1016

The front panel of The TL-SF1016DS is shown as the following figure.

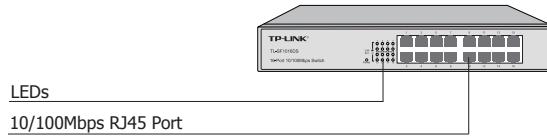

Figure 1-2 Front Panel of TL-SF1016DS

The front panel of The TL-SF1024 is shown as the following figure.

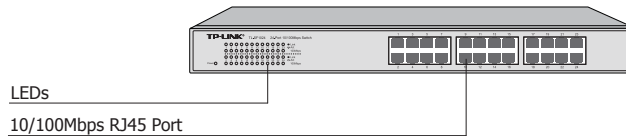

Figure 1-3 Front Panel of TL-SF1024

The front panel of The TL-SF1024D is shown as the following figure.

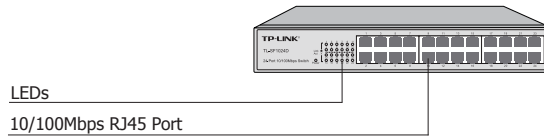

Figure 1-4 Front Panel of TL-SF1024D

The front panel of The TL-SF1048 is shown as the following figure.

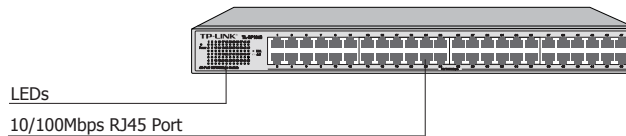

Figure 1-5 Front Panel of TL-SF1048

### LEDs

LED	Status	Indication
Power	On	The switch is powered on
	Off	The switch is powered off or power supply is abnormal
	Flashing	Power supply is abnormal
Link/Act	On	A device is linked to the corresponding port
	Flashing	Data is being transmitted or received
	Off	There is no device linked to the corresponding port
100Mbps	On	The corresponding port is running at 100Mbps
	Off	There is no device linked to the corresponding port or the port is running at 10Mbps



**Note:** Because of the difference among the switch models, some switches don't have the 100Mbps indicator, such as TL-SF1048, TL-SF1016DS and TL-SF1024D switch.

### 10/100Mbps Port

Designed to connect to the device with a bandwidth of 10Mbps or 100Mbps. Each has a corresponding 10/100Mbps LED.

### ■ Rear Panel

The rear panel of the switch is shown as the following figure.

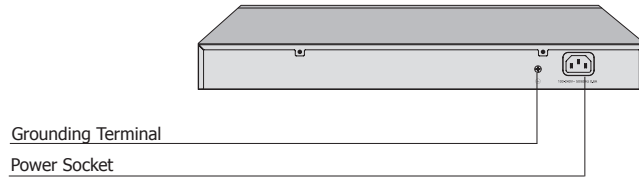

Figure 1-6 Rear Panel

### Grounding Terminal

The switch already comes with lightning protection mechanism. You can also ground the switch through the PE (Protecting Earth) cable of AC cord or with Ground Cable. For detailed information, please refer to **Chapter 3 Lightning Protection**.

### Power Socket

Connect the female connector of the power cord here, and the male connector to the AC power outlet. Please make sure the voltage of the power supply meets the requirement of the input voltage.



**Caution:** Please use the provided power cord.

---

## Chapter 2 Installation

---

### 2.1 Package Contents

---

Make sure that the package contains the following items. If any of the listed items is damaged or missing, please contact your distributor.

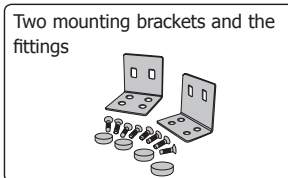
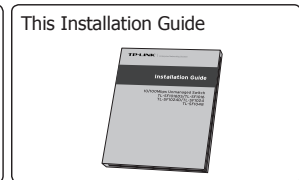
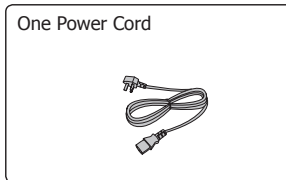
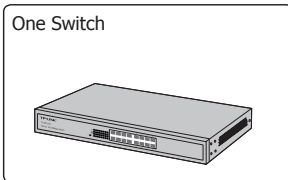

### 2.2 Safety Precautions

---

To avoid any device damage and bodily injury caused by improper use, please observe the following rules.

#### ■ Safety Precautions

- Keep the power off during the installation.
- Wear an ESD-preventive wrist strap, and make sure that the wrist strap has a good skin contact and is well grounded.
- Use only the power cord provided with the device.
- Make sure that the supply voltage matches the specifications indicated on the rear panel of the device.
- Ensure the vent hole is well ventilated and unblocked.
- Do not open or remove the cover of the device.
- Before cleaning the device, cut off the power supply. Do not clean it by the waterish cloth, and never use any other liquid cleaning method.



## ■ Site Requirements

### Temperature/Humidity



Please keep a proper temperature and humidity in the equipment room. Too high/low humidity may lead to bad insulation, electricity leakage, mechanical property changes and corrosions. Too high temperature may accelerate aging of the insulation materials and can thus significantly shorten the service life of the device. For normal temperature and humidity of the device, please check the following table.

Environment	Temperature	Humidity
Operating	0°C ~ 40°C	10% ~ 90%RH Non-condensing
Storage	-40°C ~ 70°C	5% ~ 90%RH Non-condensing

### Clearness



The dust accumulated on the device can be absorbed by static electricity and result in poor contact of metal contact points. Some measures have been taken for the device to prevent static electricity, but too strong static electricity can cause deadly damage to the electronic elements on the internal circuit board. To avoid the effect of static electricity on the operation of the device, please attach much importance to the following items:

- Dust the device regularly, and keep the indoor air clean.
- Keep the device well grounded and ensure static electricity has been transferred.

### Electromagnetic Interference

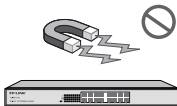

Electronic elements including capacitance and inductance on the device can be affected by external interferences, such as conducted emission by capacitance coupling, inductance coupling, and impedance coupling. To decrease the interferences, please make sure to take the following measures:

- Use the power supply that can effectively filter interference from the power grid.
- Keep the device far from high-frequency, strong-current devices, such as radio transmitting station.
- Use electromagnetic shielding when necessary.

## Lightening Protection



Extremely high voltage currents can be produced instantly when lightning occurs and the air in the electric discharge path can be instantly heated up to 20,000°C. As this instant current is strong enough to damage electronic devices, more effective lightning protection measures should be taken.

- Ensure the rack and device are well earthed.
- Make sure the power socket has a good contact with the ground.
- Keep a reasonable cabling system and avoid induced lightning.
- Use the signal SPD (Surge Protective Device) when wiring outdoor.



---

**Note:** For detailed lightning protection measures, please refer to **Chapter 3 Lightning Protection**.

---

## Installation Site

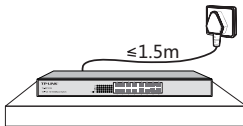

When installing the device on a rack or a flat workbench, please note the following items:

- The rack or workbench is flat and stable, and sturdy enough to support the weight of 5.5kg at least.
- The rack or workbench has a good ventilation system. The equipment room is well ventilated.
- The rack is well grounded. Keep the power socket less than 1.5 meters away from the device.

## 2.3 Installation Tools

---

- Phillips screwdriver
- ESD-preventive wrist wrap
- Cables



**Note:** These tools are not provided with our product. If needed, please self purchase them.

## 2.4 Product Installation

### ■ Desktop Installation

To install the device on the desktop, please follow the steps:

1. Set the device on a flat surface strong enough to support the entire weight of the device with all fittings.
2. Remove the adhesive backing papers from the rubber feet.
3. Turnover the device and attach the supplied rubber feet to the recessed areas on the bottom at each corner of the device.

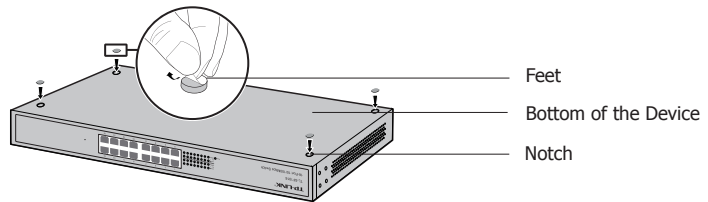

Figure 2-1 Desktop Installation

### ■ Rack Installation

To install the device in an EIA standard-sized, 19-inch rack, follow the instructions described below:

1. Check the grounding and stability of the rack.
2. Secure the supplied rack-mounting brackets to each side of the device with supplied screws, as illustrated in the following figure.

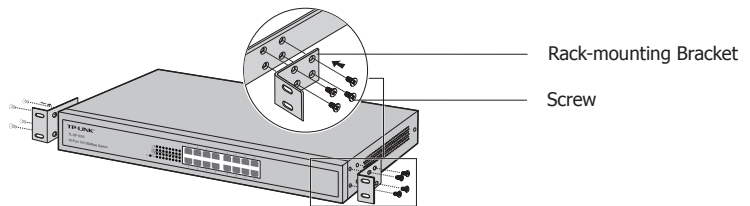

Figure 2-2 Bracket Installation

3. After the brackets are attached to the device, use suitable screws (not provided) to secure the brackets to the rack, as illustrated in the following figure.

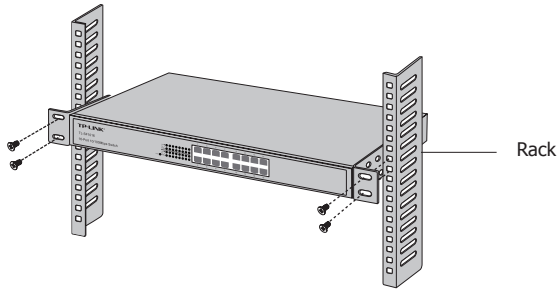

Figure 2-3 Rack Installation



**Caution:**

- Please set 5~10cm gaps around the device for air circulation.
- Please avoid any heavy thing placed on the device.
- Please mount devices in sequence from the bottom to top of the rack and ensure a certain clearance between devices for the purpose of heat dissipation.

## Chapter 3 Lightning Protection

### 3.1 Cabling Reasonably

In the actual network environment, you may need cable outdoors and indoors, and the requirements for cabling outdoors and indoors are different. A reasonable cabling system can decrease the damage of induced lightning to devices.



**Note:** It's not recommended using Ethernet cables outdoors. When cabling outdoors, please use a signal lightning arrester.

#### ■ Requirements for Cabling Outdoors

- Aerial cabling without safeguard is not allowed.

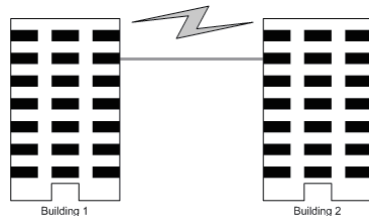

- It's not allowed cabling down the building to connect network devices in different floors.

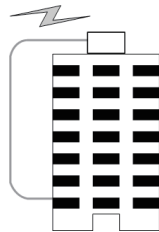

- Outdoor cables should be buried and paved to the indoor through basement. A piece of steel wire should be paved underground along the pipe and connected to the lightning protection terminal of the building for shielding. Before connecting the cable to the device, install a signal lightning arrester on the corresponding port.
- When an aerial cable is set up, the cable should be through a metal pipe (15m long at least) before coming into the building. The two ends of this metal pipe should be grounded. Before connecting the cable to the device, install a signal lightning arrester on the corresponding port.
- It's not necessary to pave STP cables through pipes. The shielded layer of STP cable should be well grounded. Before connecting the cable to the device, install a signal lightning arrester on the corresponding port.

### ■ Requirements for Cabling Indoors

When cabling indoors, keep a certain distance away from the devices that may cause high-frequency interferences, such as down-conductor cable, powerline, power transformer and electromotor.

- The main cable should be paved in the metal raceway of the access shaft. When cabling, keep the loop area formed by the cable itself as small as possible.
- Requirements for the distance between Ethernet cable and other pipelines are shown in the table.

Other Pipelines	Ethernet Cable	
	Min Parallel Net Length L (mm)	Min Parallel-overlapping Net Height H (mm)
Down-conductor	1000	300
PE	50	20
Service pipe	150	20
Compressed air pipe	150	20
Thermal pipe (not wrapped)	500	500
Thermal pipe (wrapped)	300	300
Gas pipe	300	20

The two diagrams below demonstrate parallel net length and parallel-overlapping net height.

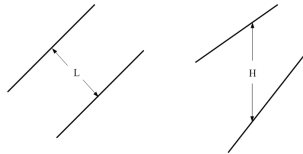

**Note:** The above minimum net length/height is required when metal raceway is not used. If any requirements cannot be met, you can add a steel tube or metal raceway for shielding.

- Requirements for the distance between Ethernet cable and high-power electric devices are in following tables.

Cable	Pave Way	Min Parallel Length (mm)
<2kVA powerline	Parallel cabling	130
	One is in the grounded metal raceway or metal pipe	70
	The both are in the grounded metal raceway or metal pipe	10

2~5kVA powerline	Parallel cabling	300
	One is in the grounded metal raceway or metal pipe	150
	The both are in the grounded metal raceway or metal pipe	80
>5kVA powerline	Parallel cabling	600
	One is in the grounded metal raceway or metal pipe	300
	The both are in the grounded metal raceway or metal pipe	150

Device	Min Distance (m)
Switch case	1.00
Transformer room	2.00
Elevator tower	2.00
Air-conditioner room	2.00

## 3.2 Connect to Ground

Connecting the device to ground is to quickly release the lightning over-voltage and over-current of the device, which is also a necessary measure to protect the body from electric shock.

In different environments, the device may be grounded differently. The following will instruct you to connect the device to the ground in two ways, connecting to the grounding bar or connecting to the ground via the power cord. Please connect the device to ground in the optimum way according to your specific operation environment.

### ■ Connecting to the Grounding Bar

If the device is installed in the Equipment Room, where a grounding bar is available, you are recommended to connect the device to the grounding bar as shown in the following figure.

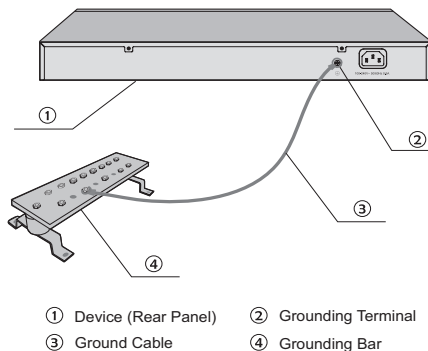

Figure 3-1 Connecting to the Grounding Bar



**Note:** The grounding bar and the ground cable are not provided with our product. If needed, please self purchase them.

### ■ Connecting to the Ground via the Power Supply

If the device is installed in the normal environment, the device can be grounded via the PE (Protecting Earth) cable of the AC power supply as shown in the following figure.

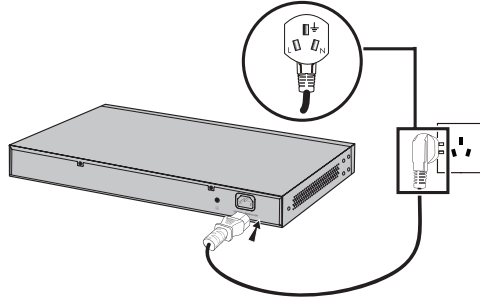

Figure 3-2 Connecting to the Ground

#### **Note:**



- The figure is to illustrate the application and principle. The power plug you get from the package and the socket in your situation will comply with the regulation in your country, so they may differ from the figure above.
- If you intend to connect the device to the ground via the PE (Protecting Earth) cable of AC power cord, please make sure the PE (Protecting Earth) cable in the electrical outlet is well grounded in advance.

## 3.3 Equipotential Bonding

Equipotential Bonding is the practice of intentionally electrically connecting all earthed systems to the same grounding grid or connecting the grounding grids of all the earthed systems together through the ground or overground metal so as to create an earthed equipotential zone. When lightning occurs, the high voltage produced by lightning current in all systems will meanwhile exist in their ground cables, and thus all ground cables have the same electrical potential and basically eliminate the electric strikes between the systems.

The figure below illustrates how to practice equipotential bonding in a network.



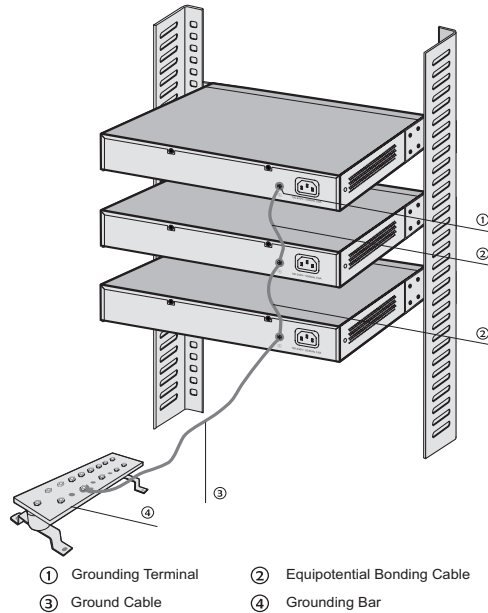

Figure 3-3 Equipotential Bonding

When equipotential bonding, please note that the cable should be copper wrapped Kelly with its area being  $6\text{mm}^2$  at least. The shorter cable the better, and use a grounding bar to establish an equipotential bonding point.



**Note:** The equipotential bonding cable is not provided with our product. If needed, please self purchase it.

### 3.4 Use Lightning Arrester

Power lightning arrester and signal lightning arrester are used for lightning protection.

Power lightning arrester is used for limiting the voltage surge due to a lightning. If an outdoor AC power cord should be directly connected to the device, please use a power lightning arrester.



**Note:** Power lightning arrester is not provided with our product. If needed, please self purchase it.

Signal lightning arrester is used to protect RJ45 ports of the device from lightning. When cabling outdoors, please install a signal lightning arrester before connecting the cable to the device.

When purchasing or using a signal lightning arrester, please observe the following rules:

- The port rate of the signal lightning arrester should match the rate of the desired port on the device. If it is not matched, this signal lightning arrester will not work. Purchase a standard lightning arrester.
- Install signal lightning arrester near the protected device and connect it to the ground via a shorter ground cable.

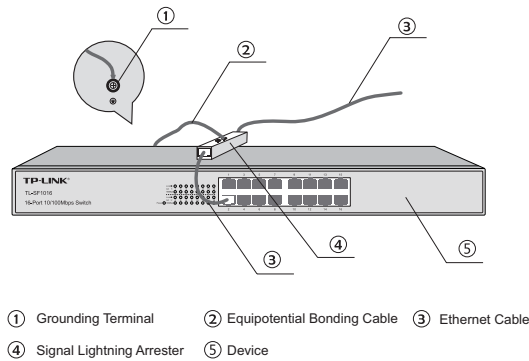

Figure 3-4 Equipotential Bonding



**Note:** Signal lightning arrester is not provided with our product. If needed, please self purchase it.

## Chapter 4 Connection

---

### 4.1 Ethernet Port

---

Connect the Ethernet ports of the switch to the network devices by RJ45 cable as the following figure shown.

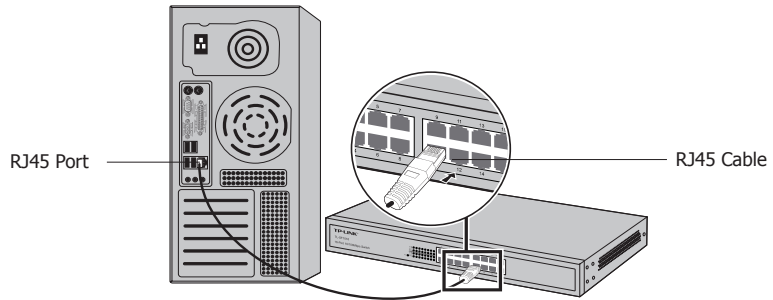

Figure 4-1 Connecting the Ethernet Port

### 4.2 Verify Installation

---

After completing the installation, please verify the following items:

- There are 5~10cm of clearance around the sides of the device for ventilation and the air flow is adequate.
- The voltage of the power supply meets the requirement of the input voltage of the device.
- The power socket, device and rack are well grounded.
- The device is correctly connected to other network devices.

### 4.3 Power On

---

Plug in the negative connector of the provided power cord into the power socket of the device, and the positive connector into a power outlet as the following figure shown.

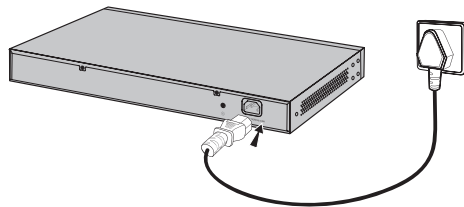

Figure 4-2 Connecting to Power Supply



---

**Note:** The figure is to illustrate the application and principle. The power plug you get from the package and the socket in your situation will comply with the regulation in your country, so they may differ from the figure above.

---

## 4.4 Initialization

---

After the device is powered on, it begins the Power-On Self-Test. A series of tests run automatically to ensure the device functions properly. During this time, its LED indicators will respond as follows:

- All of the LED indicators will flash momentarily for one second, which represents a resetting of the system.
- The Power LED indicator will light up.

## Appendix A Troubleshooting

---

### Q1. The Power LED is not lit

The Power LED should be lit up when the power system works normally. If the Power LED is not lit, please check as follows:

1. Make sure the AC power cord connected the switch with power source properly.
2. Make sure the voltage of the power supply meets the requirement of the input voltage of the switch.
3. Make sure the power source is ON.

### Q2. The Link/Act LED is not lit when a device is connected to the corresponding port

You are recommended to check the following items:

1. Make sure that the cable connectors are firmly plugged into the Switch and the device.
2. Make sure the connected device is turned on and working well.
3. The cable must be less than 100 meters long (328 feet).

## Appendix B Hardware Specifications

---

Item	Content
Standards	IEEE 802.3 10Base-T
	IEEE 802.3u 100Base-TX
	IEEE 802.3x Flow Control
Transmission Medium	10Base-T: UTP/STP of Cat. 3 or above(maximum 100m)
	100Base-TX: UTP/STP of Cat. 5 or above(maximum 100m)
Safety & Emissions	FCC, CE
Transfer Method	Store-and-Forward
MAC Address Learning	Automatically learning, automatically aging
Frame Forward Rate	10Base-T: 14881pps/Port
	100Base-Tx: 148810pps/Port
LEDs	Power, Link/Act, 100Mbps
Operating Temperature	0°C~40°C
Storage Temperature	-40°C~70°C
Operating Humidity	10%~90%RH Non-condensing
Storage Humidity	5%~90%RH Non-condensing

## Appendix C Technical Support

---

- For more help, please go to: <http://www.tp-link.com/en/support/faq>
- To download the latest Firmware, Driver, Utility and User Guide, please go to: <http://www.tp-link.com/en/support/download>
- For all other technical support, please contact us by using the following details:

Global	<p>Tel: +86 755 2650 4400          Fee: Depending on rate of different carriers, IDD.          E-mail: <a href="mailto:support@tp-link.com">support@tp-link.com</a>          Service time: 24hrs, 7 days a week</p>
Australia/New Zealand	<p>Tel: AU 1300 87 5465 (Depending on 1300 policy)          NZ 0800 87 5465 (Toll Free)          E-mail: <a href="mailto:support.au@tp-link.com">support.au@tp-link.com</a> (Australia)  <a href="mailto:support.nz@tp-link.com">support.nz@tp-link.com</a> (New Zealand)          Service time: 24hrs, 7 days a week</p>
Brazil	<p>Toll Free: 0800 608 9799 (Portuguese Service)          E-mail: <a href="mailto:suporte.br@tp-link.com">suporte.br@tp-link.com</a>          Service time: Monday to Saturday, 09:00 to 20:00; Saturday, 09:00 to 15:00</p>
France	<p>Tel: 0820 800 860 (French service)          Fee: 0.118 EUR/min from France          Email: <a href="mailto:support.fr@tp-link.com">support.fr@tp-link.com</a>          Service time: Monday to Friday 9:00 to 18:00 *Except French Bank holidays</p>
Germany/Austria	<p>Tel: +49 1805 875 465 (German Service)          +49 1805 TPLINK          +49 820 820 360          Fee: Landline from Germany: 0.14EUR/min.          Landline from Austria: 0.20EUR/min.          E-mail: <a href="mailto:support.de@tp-link.com">support.de@tp-link.com</a>          Service time: Monday to Friday, 9:00 to 12:30 and 13:30 to 17:30.          GMT+ 1 or GMT+ 2 (DST in Germany) *Except bank holidays in Hesse</p>
Indonesia	<p>Tel: (+62) 021 6386 1936          Fee: Depending on rate of different carriers.          E-mail: <a href="mailto:support.id@tp-link.com">support.id@tp-link.com</a>          Service time: Monday to Friday 9:00 to 18:00 *Except public holidays</p>
Italy	<p>Tel: +39 023 051 9020          Fee: Depending on rate of different carriers.          E-mail: <a href="mailto:support.it@tp-link.com">support.it@tp-link.com</a>          Service time: Monday to Friday, 9:00 to 13:00 and 14:00 to 18:00</p>
Malaysia	<p>Toll Free: 1300 88 875 465          Email: <a href="mailto:support.my@tp-link.com">support.my@tp-link.com</a>          Service time: 24hrs, 7 days a week</p>
Poland	<p>Tel: +48 (0) 801 080 618          +48 223 606 363 (if calls from mobile phone)          Fee: Depending on rate of different carriers.          E-mail: <a href="mailto:support.pl@tp-link.com">support.pl@tp-link.com</a>          Service time: Monday to Friday 9:00 to 17:00. GMT+1 or GMT+2 (DST)</p>

---

Russian Federation	Tel: 8 (499) 754 5560 (Moscow NO.) 8 (800) 250 5560 (Toll-free within RF) E-mail: support.ru@tp-link.com Service time: From 9:00 to 21:00 (Moscow time) *Except weekends and holidays in RF
Singapore	Tel: +65 6284 0493 Fee: Depending on rate of different carriers. E-mail: support.sg@tp-link.com Service time: 24hrs, 7 days a week
Switzerland	Tel: +41 (0) 848 800 998 (German Service) Fee: 4-8 Rp/min, depending on rate of different time. E-mail: support.ch@tp-link.com Service time: Monday to Friday, 9:00 to 12:30 and 13:30 to 17:30. GMT+ 1 or GMT+ 2 (DST)
Turkey	Tel: 0850 7244 488 (Turkish Service) Fee: Depending on rate of different carriers. E-mail: support.tr@tp-link.com Service time: 9:00 to 21:00, 7 days a week
UK	Tel: +44 (0) 845 147 0017 Fee: Landline: 1p-10.5p/min, depending on the time of day. Mobile: 15p-40p/min, depending on your mobile network. E-mail: support.uk@tp-link.com Service time: 24hrs, 7 days a week
Ukraine	Tel: 0800 505 508 Fee: Free for Landline; Mobile: Depending on rate of different carriers. E-mail: support.ua@tp-link.com Service time: Monday to Friday 10:00 to 22:00
USA/Canada	Toll Free: +1 866 225 8139 E-mail: support.usa@tp-link.com Service time: 24hrs, 7 days a week

---

**TP-LINK<sup>®</sup>**  
The Reliable Choice

---

Website: <http://www.tp-link.com> E-mail: [support@tp-link.com](mailto:support@tp-link.com)

7106504436 REV4.0.0