



**GAINWARD**  
QUICK INSTALL GUIDE



# GAINWARD

## TABLE OF CONTENTS

ABOUT THE QUICK START MANUAL	02
About The Gainward Utility DISC	02
An Important Installation Note	02
If Your Product Needs Service	02
INSTALLING YOUR NEW GAINWARD DISPLAY ADAPTER	03
Step 1: Install the New Graphics Hardware	03
Step 2: Connecting Display Devices	07
Step 3: Software Installation	09
ABOUT DirectX	10
USING EXPERTool™	11
TROUBLESHOOTING	23
TECHNICAL REFERENCE	24
Graphics Modes and Refresh Rates	24
Connector Description	25
PRODUCT CERTIFICATION STATEMENTS	27
FCC Notice	27
CSA Notice	27
CE Notice	27

## ABOUT THE QUICK START MANUAL

This manual is designed to assist a computer novice as well as an experienced computer user through an easy and uncomplicated installation of a Gainward graphics product.

Should you need a manual in a language other than English, soft copies are available in different languages in PDF file format on your Gainward UTILITY DISC.

To do this, insert the Gainward UTILITY DISC, click on "Browse", select the "MANUAL" folder, then the "VGA" folder and click on the file of your language, i.e. "ENGLISH". This will open your Acrobat Reader and display the manual.

### About The Gainward UTILITY DISC

All Gainward products ship with a DVD-Rom, which contains the latest drivers for your particular product. For updated information about a specific product that may not be included in this manual, please see the README.TXT file in the root directory on your Gainward UTILITY DISC.

### An Important Installation Note

Your new Gainward display adapter is designed to work in a PCI Express bus slot in a computer with any Intel Pentium or compatible processor (AMD, Cyrix, VIA, etc.). It will NOT operate in a PowerPC, Macintosh system or in a PCI bus slot.

### If Your Product Needs Service

If your Gainward product is defective, please contact your reseller.

Please visit [www.gainward.com](http://www.gainward.com) for more information

## INSTALLING YOUR NEW GAINWARD DISPLAY ADAPTER



If you are installing a Gainward display adapter with an extra power connector, please make sure that your PC meets the following hardware requirements:

- Your PC must have a power supply unit (PSU) of at least 400 W (please reference the information on the packaging material of your products for more detail).
- A PCI Express compliant motherboard is required.
- A vacant slot adjacent to the PCI Express x16 slot may be required. This product series may occupy two slots in your PC. Phantom series need 3 slots space.
- One or two 6-pin PCI Express power connectors (or one 8-pin and one 6-pin PCI Express power connectors) are required. Some Gainward products may include a complementary power cable to connect the display adapter card with your PC's power supply.

We went to great lengths to ensure the installation process for any Gainward graphics adapter is as easy as possible. There are three major tasks you need to complete so that you can fully enjoy your new Gainward display adapter: prepare your system, install the new display adapter, and install the display drivers and utilities. These three steps will be discussed in full detail below:

### Step 1: Install the New Graphics Hardware

1. BEFORE YOU BEGIN INSTALLING ANY HARDWARE DISCONNECT YOUR AC POWER CORD FROM YOUR PC! WE HIGHLY RECOMMEND THAT YOU ALSO DISCONNECT OTHER PERIPHERALS (i.e. printers, Monitor, etc) FROM YOUR PC Remove the necessary screws from the PC's case, and remove its cover. Consult your PC's manual to help you do this.

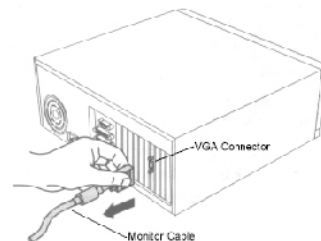

2. Touch the metal case of your PC's power supply to ground yourself. This will discharge all static electricity. It is very important to do this, because electronic components such as those inside your computer are very sensitive, and can be destroyed by an electric discharge.

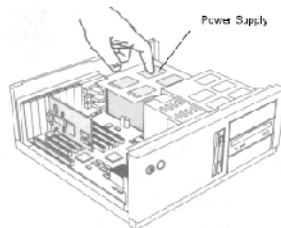

3. Remove the screw on the mounting bracket of your old VGA display adapter card.

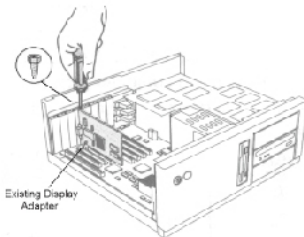

4. Remove your old VGA display adapter card by pulling it gently, in a straight, upward manner.

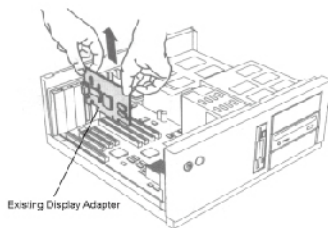

5. Remove your new Gainward display adapter from the anti static bag. If your Gainward card has a fan, please make sure not to touch it!

Touch the metal case of your PC's power supply again to ground yourself. This will discharge all static electricity.

Insert the new Gainward card in the appropriate PCI Express x16 slot, making sure that it is firmly seated. Be gentle when pushing it straight into the slot. Do not use brute force! Do not bend or flex the card.

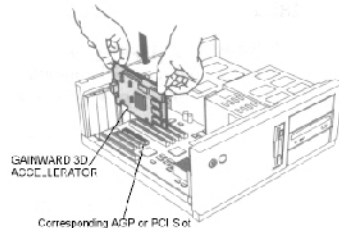

6. Re-attach the screw on the mounting bracket of your Gainward card. This is very important, as when the monitor cable is attached later, the display adapter card may work loose, and your computer will not operate correctly.

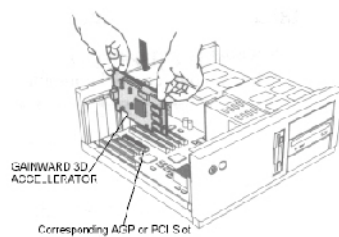

**Skip to step 8 if the Gainward display adapter has no extra power connector!**

7. Connect the female connector of **6-pin (or 8-pin) PCI Express power cable** from your computer's power supply to the power connector on the back of the graphics card. (Or, connect the female connector of the **supplementary power cable** to the power connector on the back of the graphics card. Then, attach those two male connectors on the cable to matching connectors from your computer's power supply.) **The display adapters will not operate without the additional power source.**

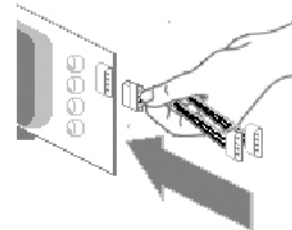



**Supplementary power cable**

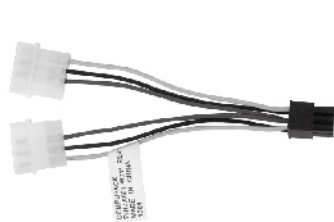

for 4-pin HDD power(from PSU)\*2 to 6-pin

or



for 6-pin(from PSU)\*2 to 8-pin

8. Replace the cover on your PC, and tighten its screws.  
 Connect the monitor cable to your new Gainward display adapter card. Reconnect the AC power cord to your PC.  
 The hardware installation is now complete.

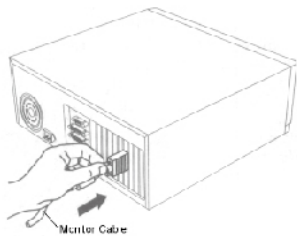

**Step 2: Connecting display devices**

Your new Gainward display adapter supports several display devices. The following figures show the connectors for all display devices you can connect to:

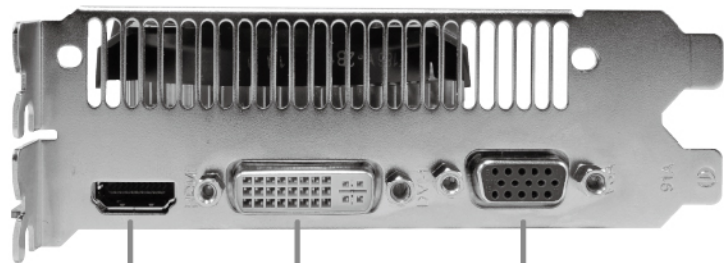

HDMI

DVI-I

VGA

<b>VGA</b> connector	Connecting CRT monitor or LCD monitor with VGA connector
<b>DVI</b> connector	Connecting LCD monitor (DFP) with a digital connector
<b>HDMI</b> connector	Connecting HDMI display device
<b>DVI-VGA</b> converter	Converting DVI-I to support VGA connector

Your new Gainward display adapter provides dual display functionality. The following table lists the different ways you can connect displays to your card.

Display configurations	Connector	Note
Single CRT monitor or LCD monitor with VGA connector	VGA connector	
Single CRT monitor or LCD monitor with VGA connector	DVI-I connector with DVI-VGA converter	
Single LCD monitor (DVI port)	DVI-I connector	
CRT monitor + LCD monitor (DVI port)	VGA connector + DVI-I connector	
HDMI display device + LCD monitor (DVI port)	HDMI connector + DVI-I connector	Note #1
HDMI display device + LCD monitor with VGA connector	HDMI connector + VGA connector	Note #1

**Note #1**

To proper use the **HDMI** display device you just connect the **HDMI** cable (it will come with your HDMI display device) to the HDMI connector of the Gainward **HDMI** display adapter.

**Step 3: Software Installation****Note:**

To make sure the system reliability we strongly recommend you to remove the old display driver that system had installed for the old display adapter.

1. Turn your computer and monitor on and boot the operating system. The operating system (Windows 8 / Windows 7 / Vista) will attempt to detect your new Gainward display adapter, and then try to install the drivers that it can find. Since these drivers are usually much older, and very generic, you will not be able to benefit from many of the adapter's advanced features and enhanced performance.
2. Insert the Gainward DRIVER & UTILITY DISC. This DVD-ROM has an auto-start feature. The installation software will detect the version of your operating system and it will then install all necessary drivers and utility programs. Just sit back and relax as the software installation may take a few moments.



3. During the process of installation, you will be asked if you would like to install utilities such as EXPERTool™ and DirectX. It is highly recommended to install both. This will allow you to take full advantage of all advanced features that come with your new Gainward display adapter
4. When the installation process is completed, you will be asked to reboot your computer. Congratulations! You have successfully installed your Gainward display adapter!

### ABOUT DirectX

The Gainward DRIVER & UTILITY DISC includes Microsoft's DirectX. This is a set of APIs that make games and multimedia applications run faster on Windows based computers. DirectX is a thin software layer that provides direct access to hardware services. This technology takes full advantage of available hardware accelerators and emulates accelerator services when accelerators are not present. DirectX components include: DirectDraw (provides 2-D graphics services), Direct3D (provides 3-D graphics services), DirectSound (provides sound-mixing and playback services), DirectPlay (provides multiplayer game connectivity over the Internet), and DirectInput (provides services for joysticks and other input devices). Gainward has included the most recent version of DirectX on the Gainward DRIVER & UTILITY DISC. You may choose to install DirectX automatically during initial display driver installation (recommended), or at any later time. From time to time, Microsoft will update DirectX and other software components. Choose "Windows Update" from the "Start" menu. This will connect you directly with Microsoft's update web site on the Internet and make all necessary updates available to you, by analyzing which software is already installed on your system.

### USING EXPERTool™

#### What is EXPERTool™?

EXPERTool™ is an utility program for the graphics card under Windows, and provides you to boost performance of the graphics card and to monitor the GPU information, which will only function correctly in conjunction with your new Gainward display adapter.

Most likely, you chose to install EXPERTool™ during our initial display driver installation process. In this case the EXPERTool™ icon is located in the "System Tray" of your Windows' task bar (in the lower right-hand corner of your Windows desktop).

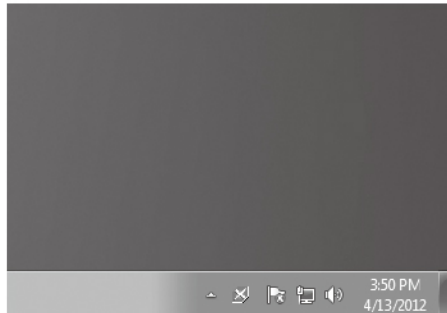

If you have not yet installed EXPERTool™, you can do so now by running our Gainward DRIVER & UTILITY DISC

To launch EXPERTool™, simply click on the small 'X' – icon in the System Tray, and a pop-up menu (UI) will appear on your screen.



**EXPERTool UI** shows the important information such as GPU clock speed, memory clock speed, fan duty cycle and GPU temperature. And, a lot more features to provide advanced user more detail information for over-clocking. The newer version is easier to understand and easier to use, everything you need is on one single, well organized page!

#### Main functions:

<b>FAN DUTY Adjustment</b>	to adjust cooling fan speed
<b>OVER-CLOCKING</b>	to adjust GPU core clock and memory clock
<b>USER MODE</b>	for user to store the favorite mode for different application
<b>BIOS Loading</b>	to store the BIOS of the graphics card
<b>SETTING</b>	to change from the EXPERTool's original setting by their requirement
<b>STATUS</b>	to shows the current value of the graphics card
<b>INFO (INFORMATION)</b>	to show the information of your graphics card
<b>RESTORE</b>	to reset all the setting or adjustment to original setting
<b>OTHERS</b>	

**FAN DUTY Adjustment**

Users can adjust the fan's speed of the graphics card by push the "ADJUST" button. If you try to lower the temperature of the GPU while playing games, please draw the slider bar to higher "FAN DUTY" to increase fan speed. Or, if you want to lower the fan speed to keep lower acoustic level, set fan to lower "FAN DUTY" to decrease the fan speed.

For normal operation, please set back to "AUTO" fan control mode that will automatically adjust the fan's speed to keep the GPU temperature under safe level.

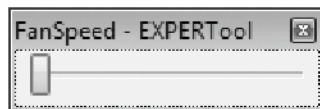

The GPU temperature is shown in C (Celsius). Or, you can change it to show in F (Fahrenheit).

For any operation condition, please keep the GPU temperature under 90 degree C.

**OVER-CLOCKING**

To adjust the core speed or memory speed of the card, you need to push the "G" button and go into over-clocking page.

In order to adjust the "Graphics clock", "Memory clock", "Core Voltage", "Power Limit" and "Frame Rate Target", please draw the slider bars to over-clocking the board.

You can change both the core clock and/or the memory clock settings independently. The higher the clock settings, the faster your graphics card will work.

For the GTX 600 series (and above), increase "Power Limit" will increase the performance as well.

Please note that not every board can be over-clocked too much, there will be different limitation to over-clocking.

You also can control "Frame Rate Target". For example, set FPS target at 90 FPS (other than MAX) that the graphics will not run top speed to save some power consumption and still have very good gaming quality.

**Notice: Do take care while doing over-clocking**

Change the speed in small increments only, i.e. in increments of 5~10 MHz. Then check if your games are still running correctly. If you start seeing abnormal frames on your screen, or your 3D graphics appear in a "broken" fashion, you have exceeded the board's capabilities, and you must revert to your previous setting.

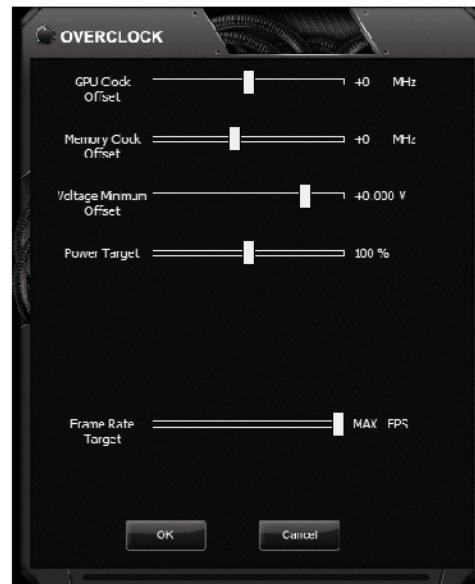

## USER MODE

"USER MODE" is used for user to preset up to 5 different modes for different operation condition. After carefully adjusting the fan's duty, core speed and memory speed, press "SAVE" button and then press one of those five buttons to save one of your favorite modes.

To select the user mode, you just press the number of the mode you save. Save your favorite user mode.

Step-1 Adjust the settings

Step-2 Click "SAVE" button

Step-3 Choose user mode number (1~5) to save

## BIOS LOADING

This function is for users to load the VGA bios and save in the system for future usage.

Just press "BIOS" button to start:

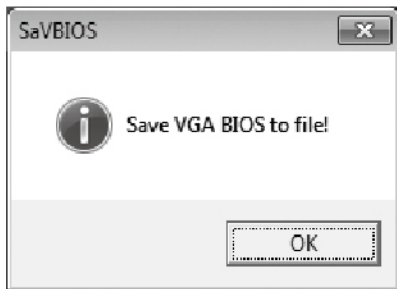

Then, system will ask you the file name to save file BIOS file.

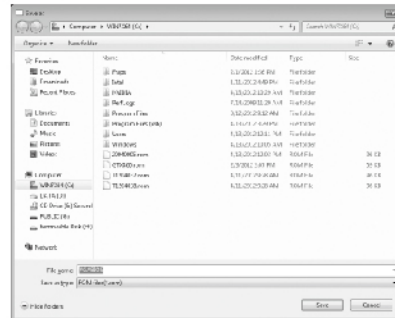

You just enter the file name then system start copying the BIOS to the file.

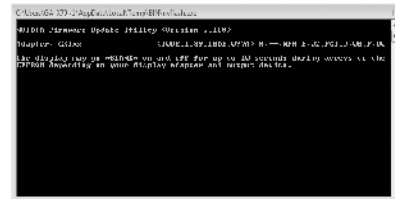
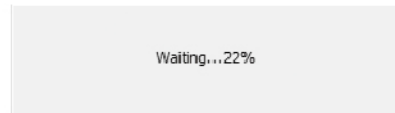



Please wait...

It will take within one minute to copy the BIOS file.

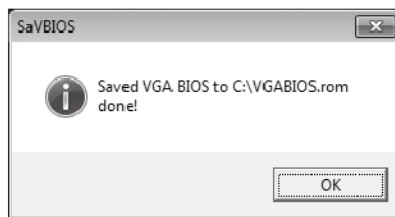

## SETTING

Users can make some change from the EXPERTool's original setting by their requirement.

- Display the "current clock speed" on the UI or "GPU base clock" (or 3D clock for 500 series)
- Load Expertool while Windows startup or not
- Enable ToolTips

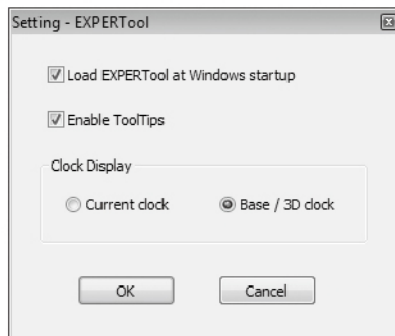

## STATUS

It shows the current value such as core clock speed, memory clock speed, fan speed (duty cycle), core voltage and others. Users can check those values any time while running application software.

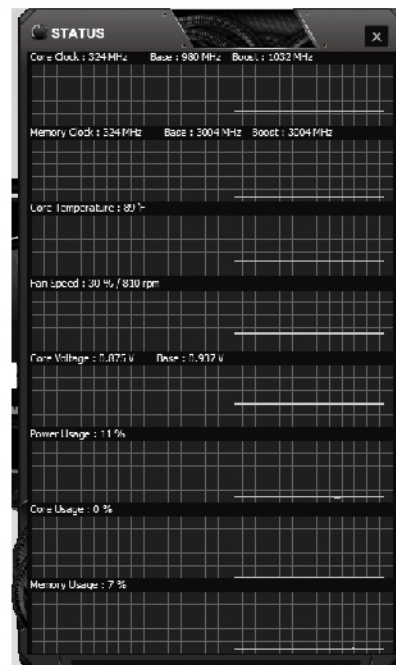

**INFO (information)**

This page gives you a very detailed status report on your Gainward card's current operating environment, such as the model, current display settings, current software and driver versions, etc. This could be helpful in the event you run into a problem and need to talk to technical support.

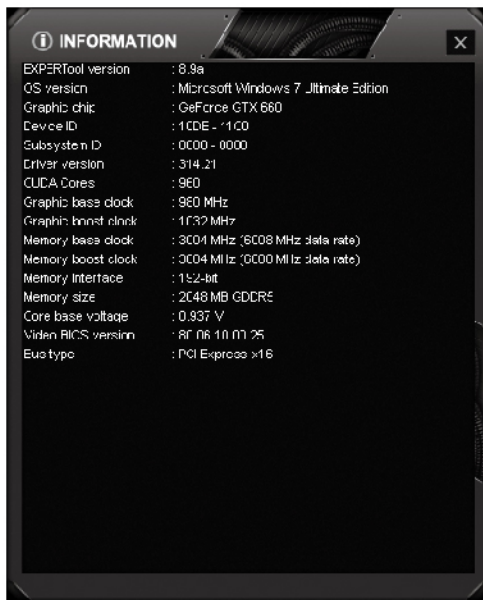
**RESTORE**

This function is to reset all the setting or adjustment to original setting.

**Others**

From the UI (user interface), users can press NVIDIA LOGO to go to NVIDIA CONTROL PANEL by their requirement.

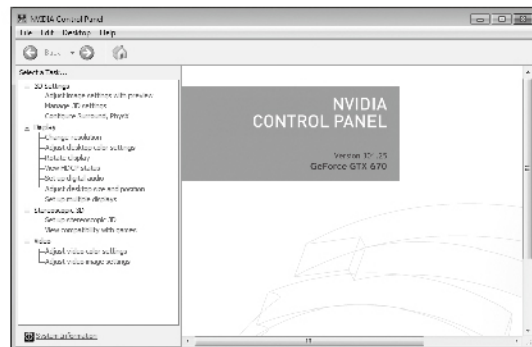

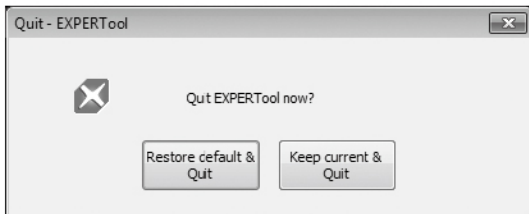
**Quit**

Quit from the UI (user interface), user can press

**“Restore default & Quit”** if you want to discard any change and keep the board to run with the factory setting.

Or, press

**“Keep current & Quit”** if you want to keep the changes you have made for the board.

**TROUBLESHOOTING**

This section contains a list of symptoms that may indicate a problem with your software or hardware and some troubleshooting steps you can take to solve the problem. If you still have problems after trying our suggestions or if you're having a problem that is not described below, please contact us. We'll be glad to assist you. See the "CONTACTING GAINWARD" section in this manual for more details.

**The system doesn't boot when it's turned on, there is no display, and the PC beeps abnormally.**

This probably means that your new display adapter isn't correctly seated in the PCI-E slot. Try the following:

1. Turn off your PC.
2. Remove your new Gainward display adapter from the PCI-E slot and reseal it. The card should fit into the bus slot perfectly.
3. Re-attach the monitor cable to your Gainward card and turn on the PC's power. If the problem persists repeat step 2
4. If you have another PC available, you may wish to try installing the display adapter in another PC before calling Gainward. This will help narrow down the cause of the problem.

**The system appears to boot normally when it's turned on but there is no display on the monitor.**

This probably means that your monitor isn't operating or isn't connected to the display adapter correctly. Try the following:

1. While the PC is still on, make sure that the monitor is plugged into an electrical outlet and is turned on.
2. Turn off your PC. Reattach the monitor's video cable to your display adapter. This helps rule out the possibility of a loose connection between the display adapter and the monitor. Verify that the display adapter is still tightly seated in its bus slot.
3. Turn on power to your PC. If the problem still occurs take another look at the monitor. Many monitors have an indicator or display that tells you whether or not the monitor is receiving a video signal from the display adapter. This information will help if you have to contact Gainward.
4. If necessary remove the Gainward card and reinstall your old display adapter to verify that the monitor works correctly with the old display adapter.

## TECHNICAL REFERENCE

## Graphics Modes and Refresh Rates

Resolution	256color/High color (16bits)	True color (32bits)	Note
640 x 480	60 – 240 Hz	60 – 240 Hz	
800 x 600	60 – 240 Hz	60 – 240 Hz	DVI monitor support up to 200Hz
1024 x 768	60 – 240 Hz	60 – 200 Hz	DVI monitor support up to 140Hz
1152 x 864	60 – 200 Hz	60 – 170 Hz	DVI monitor support up to 100Hz
1280 x 768	60 – 170 Hz	60 – 150 Hz	DVI monitor support up to 100Hz
1280 x 960	60 – 170 Hz	60 – 150 Hz	DVI monitor support up to 85Hz
1280 x 1024	60 – 170 Hz	60 – 150 Hz	DVI monitor support up to 85Hz
1360 x 768	60 – 170 Hz	60 – 150 Hz	DVI monitor support up to 85Hz
1600 x 900	60 – 150 Hz	60 – 120 Hz	DVI monitor support up to 72Hz
1600 x 1024	60 – 120 Hz	60 – 100 Hz	DVI monitor support up to 60Hz
1600 x 1200	60 – 120 Hz	60 – 100 Hz	DVI monitor support up to 60Hz
1680 x 1050	60 – 120 Hz	60 – 100 Hz	DVI monitor support up to 60Hz
1920 x 1080	60 – 100 Hz	60 – 85 Hz	DVI monitor support up to 60Hz
1920 x 1200	60 – 100 Hz	60 – 85 Hz	DVI monitor support up to 60Hz
1920 x 1440	60 – 85 Hz	60 – 85 Hz	“Dual-Link” DVI monitor
2048 x 1536	60 – 85 Hz	60 – 85 Hz	“Dual-Link” DVI monitor
2560 x 1600	60 Hz	60 Hz	“Dual-Link” DVI monitor

## Connector Description

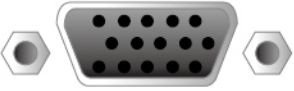
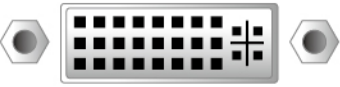
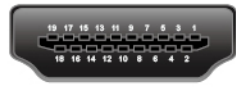
 <p><b>Analog VGA Connector</b></p>	1	Red Video	9	+ 5V
	2	Green Video	10	Sync Return (Ground)
	3	Blue Video	11	NC
	4	NC	12	DDC DATA
	5	Ground	13	Horizontal Sync
	6	Red Return (Ground)	14	Vertical Sync
	7	Green Return (Ground)	15	DDC CLOCK
	8	Blue Return (Ground)		
 <p><b>DVI Connector</b></p>	1	TX2-	13	TX3+
	2	TX2+	14	+5V Power
	3	SHLD 2/4	15	Ground
	4	TX4-	16	HPD
	5	TX4+	17	TX0-
	6	DDC_CLK	18	TX0+
	7	DDC_DAT	19	SHLD 0/5
	8	Vertical Sync	20	TX5-
	9	TX1-	21	TX5+
	10	TX1+	22	SHLD Clock
	11	SHLD 1/3	23	TXC+
	12	TX3-	24	TXC-
 <p><b>HDMI Connector</b></p>	1	TMDS Data2+	2	TMDS Data2 Shield
	3	TMDS Data2-	4	TMDS Data1+
	5	TMDS Data1 Shield	6	TMDS Data1-
	7	TMDS Data0+	8	TMDS Data0 Shield
	9	TMDS Data0-	10	TMDS Clock+
	11	TMDS Clock Shield	12	TMDS Clock-
	13	CEC	14	Reserved
	15	SCL	16	SDA



DisplayPort Connector

1	ML Lane 0+	2	GND
3	ML Lane 0-	4	ML Lane 1+
5	GND	6	ML Lane 1-
7	ML Lane 2+	8	GND
9	ML Lane 2-	10	ML Lane 3+
11	GND	12	ML Lane 3-
13	CONFIG1	14	CONFIG2
15	AUX CH+	16	GND
17	AUX CH-	18	Hot Plug
19	Return	20	DP_PWR



6-pin power connector

1	+12V
2	+12V
3	+12V
4	Ground
5	Sense
6	Ground

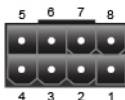

8-pin power connector

1	+12V
2	+12V
3	+12V
4	Sense1
5	Ground
6	Sense0
7	Ground
8	Ground

## PRODUCT CERTIFICATION STATEMENTS

This device complies with Part 15 of the FCC Rules. Operation is subject to the following two conditions:

1. This device may not cause harmful interference.
2. This device must accept any interference received, including interference that may cause undesired operation.

**FCC Notice:** This equipment has been tested and found to comply with the limits for a Class B digital device, pursuant to Part 15 of the FCC Rules. These limits are designed to provide reasonable protection against harmful interference in a residential installation.

This equipment generates, uses, and can radiate radio frequency energy, and if not installed and used in accordance with manufacturer's instructions, may cause harmful interference to radio communications. However, there is no guarantee that interference will not occur in a particular installation.

If this equipment does cause interference to radio or television reception, which can be determined by turning the equipment off and on, the user is encouraged to try to correct the interference by one or more of the following measures:

- Reorient or relocate the receiving antenna.
- Increase the separation between the equipment and receiver.
- Plug the computer into a different outlet so that the two devices are on different branch circuits.
- If necessary, the user should consult the dealer or an experienced radio/television technician for additional suggestions.

**Warning:** Shielded interface cables must be used in order to comply with emission limits.

Changes or modifications not expressly approved by the party responsible for compliance could void the user's authority to operate the equipment.

**CSA Notice:** This digital apparatus does not exceed the Class B limits for radio noise emissions from digital apparatus set out in the Radio Interference Regulations of the Canadian Department of Communications.

**CE Notice:** This electronic device is designed for home and office use only, and it has been tested and certified to fully comply with CE standards set forth by the European Community.

## Installation rapide des pilotes

Nous recommandons vivement aux utilisateurs de Windows 8 / Windows 7 / Windows Vista de suivre la procédure d'installation.

**Etape 1** Insérez le DVD de pilotes dans le Blu-ray Disc ou le DVD-Rom.



**Etape 2**  
Le lancement automatique démarre, sélectionnez « Lancez Nvsetup.exe ».



**Etape 3**  
Cliquez sur « Install Drivers ».



**Etape 4**  
L'installation des pilotes commence, cliquez sur « Suivant » pour continuer.

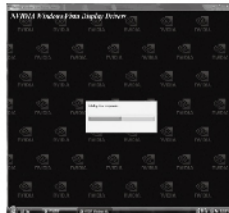

**Etape 5**  
L'installation des pilotes peut prendre un certain temps, patientez.

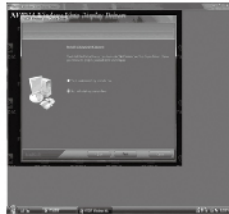

**Etape 6**  
L'installation est terminée, sélectionnez « oui » et appuyez sur le bouton « Fin » pour finaliser la procédure d'installation. Redémarrez votre ordinateur.

## Schnell Installation

Wir empfehlen Windows 8/Windows 7/Windows Vista Nutzern nachfolgenden Installationsvorgang:

**Schritt 1** Legen Sie die Treiber DVD in Ihr Blu-ray Disc oder DVD-ROM Laufwerk ein.



**Schritt 2**  
Autostart beginnt. Auf dem Bildschirm erscheint folgende Meldung: Bitte "Run Nvsetup.exe" auswählen.



**Schritt 3**  
Auf dem Bildschirm erscheint folgendes Bild Bitte wählen Sie "Treiber installieren" um fortzufahren.



**Schritt 4**  
Windows installiert den Treiber. Bitte drücken Sie auf "Weiter" um fortzufahren.

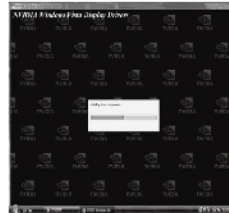

**Schritt 5**  
Treiber Installation benötigt einen Moment. Bitte warten.



**Schritt 6**  
Die Installation ist beendet. Bitte wählen sie "Ja" und drücken Sie "Beenden" um den Vorgang abzuschliessen. Bitte starten Sie den Rechner erneut.



**Guida veloce all'installazione dei Driver:**  
Raccomandiamo agli utenti di Windows 8 / Windows 7 / Windows Vista di utilizzare la seguente procedura di installazione:

**Punto 1** Inserire il DVD dei Driver in un lettore Blu-ray Disc o in un lettore DVD-ROM.



**Punto 2**  
L' AutoPlay partirà in automatico e verrà visualizzata la seguente schermata:  
Per cortesia selezionare **"Run Nvsetup.exe"**



**Punto 3**  
Verrà visualizzata la seguente schermata di installazione:  
Per cortesia selezionare **"Install Drivers"** per proseguire.



**Punto 4**  
Verrà visualizzata la seguente schermata di installazione:  
Per cortesia selezionare **"Install Drivers"** per proseguire.

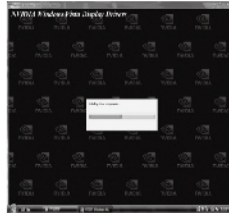

**Punto 5**  
Per favore attendere che l'installazione dei driver sia completata, questa operazione potrebbe impiegare alcuni minuti:



**Punto 6**  
L'installazione dei driver è completata, per cortesia selezionare **"Yes"** e premere sul pulsante **"Finish"** per completare la procedura d'installazione. Il computer eseguirà un riavvio.

Windows 8 / Windows 7 / Windows Vista の場合

クイックドライバインストールを利用した、ドライバのインストールをお勧めいたします。

ステップ1 DVDまたはBlu-ray Discドライブにドライバ DVD を入れます。



ステップ2  
選択画面が表示されるので「Run Nvsetup.exe」をクリックします。



ステップ3  
メニュー画面が表示されるので、「Install Drivers」をクリックします。



ステップ4  
Windowsにドライバのインストールを開始します。「NEXT」をクリックします。



ステップ5  
ドライバをインストールしています。完了するまでお待ちください。

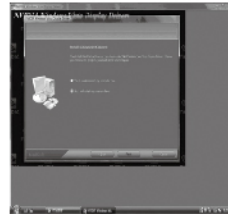

ステップ6  
ドライバインストールが完了しました。「Yes」をクリックし、次に「Finish」をクリックします。  
インストールを完了するために、PCを再起動してください。

**Szybka instalacja sterowników**

Bardzo prosimy użytkowników systemów Windows 8 / Windows 7 / Windows Vista o wykonanie poniższej procedury instalacyjnej.

**Krok 1** Włóż dysk instalacyjny DVD do stacji Blu-ray Disc lub DVD-ROM



**Krok 2**  
Po pojawieniu się ekranu Autorun wybierz **“Run Nvsetup.exe”**



**Krok 3**  
Po pojawieniu się ekranu instalacyjnego wybierz **„Install Drivers”**



**Krok 4**  
System Windows rozpocznie procedurę instalowania sterowników, wybierz **„Next”**, aby kontynuować



**Krok 5**  
Instalacja sterowników może zająć kilka minut, w tym czasie na ekranie będzie wyświetlany wskaźnik postępu instalacji

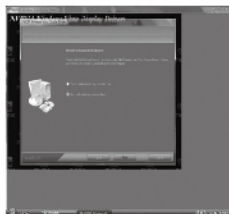

**Krok 6**  
Po zakończeniu instalacji sterowników wybierz **“Yes”**, a następnie **„Finish”**. Procedura instalacji zakończy się, a komputer automatycznie zrestartuje.

**Instalação Rápida do Driver**

Nós recomendamos aos usuários do Windows 8 / Windows 7 / Windows Vista que sigam estes procedimentos de instalação:

**Etapa 1** Insira o DVD no drive de Blu-ray Disc ou DVD-ROM de seu computador.



**Etapa 2**  
A janela de diálogo abrirá automaticamente conforme figura ao lado. Por favor, selecione: **“Executar (Run) Nvsetup.exe”**.



**Etapa 3**  
A tela do programa de instalação abrirá conforme figura ao lado. Por favor, selecione **“Install Drivers”** para continuar.



**Etapa 4**  
O Windows está instalando os Drivers, por favor, pressione **“Próximo (Next)”** para continuar.

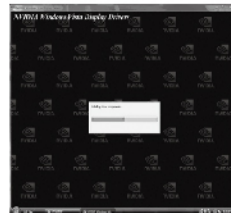

**Etapa 5**  
A instalação do Driver levará algum tempo, por favor, aguarde.

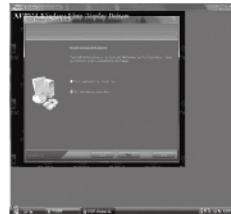

**Etapa 6**  
A instalação foi concluída, por favor, selecione **“Sim (Yes)”** e pressione o botão **“Finalizar (Finish)”** para completar o processo. Reinicie seu computador.

**Ghid de Instalare Rapida a Driverului**

Recomandam utilizatorilor de Windows 8 / Windows 7 / Windows Vista sa urmeze procedura de instalare:

**Pasul 1** Se introduce DVD-ul ce contine driver-ul in unitatea Blu-ray Disc sau DVD-ROM.



**Pasul 2**  
AutoPlay va rula iar ecranul va arata dupa cum urmeaza:  
Se selecteaza **“Run Nvsetup.exe”**



**Pasul 3**  
Ecranul de instalare va arata astfel:  
Se selecteaza **“Install Drivers”** pentru a continua



**Pasul 4**  
Windows-ul instaleaza driverele, se apasa **“Next”** pentru a continua:

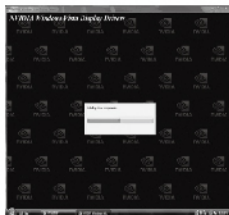

**Pasul 5**  
Se asteapta cateva momente pana cand driver-ul se va instala

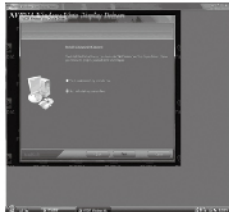

**Pasul 6**  
Instalarea driver-ului a luat sfarsit, se selecteaza **“Yes”** si se apasa **“Finish”** pentru a completa procesul de instalare. Se porneste din nou computerul.

**Быстрая установка драйверов**

Мы настоятельно рекомендуем пользователям Windows 8 / Windows 7 / Windows Vista следовать следующей инструкции:

**Шаг 1** Вставьте DVD с драйверами в Blu-ray Disc или DVD-ROM накопитель.



**Шаг 2**  
Автоматически запустится приложение и появится окно, приведенное ниже:  
Выберите **“Запустить (Run) Nvsetup.exe”**



**Шаг 3**  
На экране появится нижеследующее диалоговое окно:  
Выберите **“Установить драйвер (Install Drivers)”** для продолжения.



**Шаг 4**  
Windows произведет установку, нажмите Далее (“Next”):

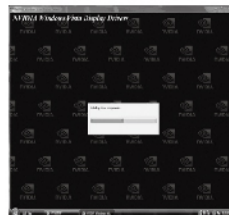

**Шаг 5**  
Установка драйвера займет некоторое время, пожалуйста подождите:



**Шаг 6**  
После того, как установка завершится, выберите Да (“Yes”) и нажмите кнопку Готово (“Finish”) для завершения.  
Перезагрузите компьютер.

**Instalación rápida del Driver**

Recomendamos encarecidamente a los usuarios de Windows 8 / Windows 7 / Windows Vista que sigan el procedimiento de instalación:

**Paso 1** Inserte el Driver DVD en el Blu-ray Disc o dispositivo DVD-ROM.



**Paso 2**

El AutoPlay se iniciará y la pantalla mostrará lo siguiente:  
Por favor seleccione **“Run Nvsetup.exe”**



**Paso 3**

La pantalla de instalación mostrará lo siguiente:  
Por favor seleccione **“Install Drivers”** para continuar.



**Paso 4**

La ventana se encuentra instalando los drivers, por favor presione **“Next”** para continuar:

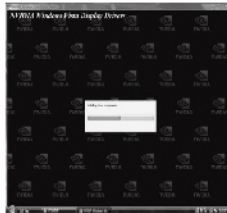

**Paso 5**

El dispositivo de instalación puede tomar algún tiempo, por favor espere:



**Paso 6**

Instalación del driver finalizada, por favor seleccione **“Yes”** y presione el botón **“Finish”** para completar el procedimiento de instalación. A continuación, reinicie su ordenador.

**Hızlı Sürücü Kurulumu**

Windows 8 / Windows 7 / Windows Vista kullanıcılarının aşağıdaki yükleme sürecini takip etmesi şiddetle önerilir.

**Adım 1** Sürücü DVD'sini, DVD ya da Blu-ray Disc sürücünüze yerleştiriniz.



**Adım 2**

DVD otomatik olarak çalıştırılacaktır, karşınıza çıkacak olan ekranda **“Run Nvsetup.exe”**i seçiniz.



**Adım 3**

Kurulum ekranı yandaki gibi karşınıza çıkacaktır, devam etmek için **“Install Drivers”**ı seçiniz.



**Adım 4**

Windows kurulumu başlayacaktır. Devam etmek için **“Next”**e basınız.

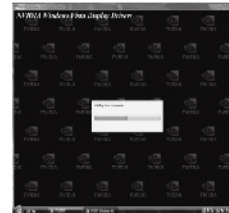

**Adım 5**

Sürücünün yüklenmesi biraz zaman alacaktır. Lütfen bekleyiniz.



**Adım 6**

Sürücü yüklemesini tamamlamak için ilk olarak **“Yes”**i sonra da **“Finish”**i seçiniz ve bilgisayarınızı yeniden başlatınız.

### **Copyrights and Liabilities**

The information contained in this manual has been validated at the time of publication. The manufacturer reserves the right to make any changes and improvements to the products described in this manual at any time and without prior notice. Consequently, the manufacturer assumes no liability for damages incurred directly or indirectly from errors, omissions or discrepancies between the product and the manual.

All registered trademarks are the property of their respective owners.

Copyright © 2005 All rights reserved. No reproduction of this document in any form is permitted without the prior written authorization from the manufacturer.

### **Trademark**

All products and company names are trademarks or registered trademarks of their respective holders.

**GAINWARD**  
[www.gainward.com](http://www.gainward.com)

M-GW19