

Acer Projector

PL1620n/PL1520i/PL1325W/PL1320W/PL1220/
SL1520i/SL1320Wn/SL1220n/

FL162/FL152/FL221A/FL122/FL112/FL152S/
FL122S/FL112S/

LU-P200U/LU-P200F/LU-P500WA/LU-P200W/
LU-P200X/LU-S200F/LU-S200W/LU-S200X/

PF-L200U/PF-L200F/PF-L500WA/PF-L200W/
PF-L200X/PS-L200F/PS-L200W/PS-L200X/

LR630/LR530/LR335/LR330/LR230/LR530S/
LR330S/LR230S/

ML-530/ML-430/ML-235/ML-230/ML-130/
ML-430S/ML-230S/ML-130S/VL6530i

DWU1902/D1P1903/DWX1904/DNX1905/
D1P1906/DWX1907/DNX1908

User's Guide

Copyright © 2019. Acer Incorporated.
All Rights Reserved.

Acer Projector User's Guide
Original Issue: 08/2019

Changes may be made periodically to the information in this publication without obligation to notify any person of such revisions or changes. Such changes will be incorporated in new editions of this manual or supplementary documents and publications. This company makes no representations or warranties, either expressed or implied, with respect to the contents hereof and specifically disclaims the implied warranties of merchantability or fitness for a particular purpose.

Record the model number, serial number, purchase date and place of purchase information in the space provided below. The serial number and model number are recorded on the label affixed to your projector. All correspondence concerning your unit should include the serial number, model number and purchase information.

No part of this publication may be reproduced, stored in a retrieval system, or transmitted, in any form or by any means, electronically, mechanically, by photocopy, recording or otherwise, without the prior written permission of Acer Incorporated.

Model number: _____

Serial number: _____

Date of purchase: _____

Place of purchase: _____

Acer and the Acer logo are registered trademarks of Acer Incorporated. Other companies' product names or trademarks are used herein for identification purposes only and belong to their respective companies.

HDMI™, the HDMI logo and High-Definition Multimedia Interface are trademarks or registered trademarks of HDMI Licensing LLC.



Information for your safety and comfort

Read these instructions carefully. Keep this document for future reference. Follow all warnings and instructions marked on the product.

Turning the product off before cleaning

Unplug this product from the wall outlet before cleaning. Do not use liquid cleaners or aerosol cleaners. Use a damp cloth for cleaning.

Caution for plug as disconnecting device

Observe the following guidelines when connecting and disconnecting power to the external power supply unit:

- Install the power supply unit before connecting the power cord to the AC power outlet.
- Unplug the power cord before removing the power supply unit from the projector.
- If the system has multiple sources of power, disconnect power from the system by unplugging all power cords from the power supplies.

Caution for Accessibility

Be sure that the power outlet you plug the power cord into is easily accessible and located as close to the equipment operator as possible. When you need to disconnect power to the equipment, be sure to unplug the power cord from the electrical outlet.

Warning!

- Do not use this product near water.
- Do not place this product on an unstable cart, stand or table. If the product falls, it could be seriously damaged.
- Slots and openings are provided for ventilation to ensure reliable operation of the product and to protect it from overheating. These openings must not be blocked or covered. The openings should never be blocked by placing the product on a bed, sofa, rug or other similar surface.
- This product should never be placed near or over a radiator or heat register, or in a built-in installation unless proper ventilation is provided.
- Never push objects of any kind into this product through cabinet slots as they may touch dangerous voltage points or short-out parts that could result in a fire or electric shock. Never spill liquid of any kind onto or into the product.
- To avoid damage of internal components and to prevent battery leakage, do not place the product on a vibrating surface.
- Never use it under sporting, exercising, or any vibrating environment which will probably cause unexpected short current or damage rotor devices.

Using electrical power

- This product should be operated from the type of power indicated on the marking label. If you are not sure of the type of power available, consult your dealer or local power company.
- Do not allow anything to rest on the power cord. Do not locate this product where people will walk on the cord.
- If an extension cord is used with this product, make sure that the total ampere rating of the equipment plugged into the extension cord does not exceed the extension cord ampere rating. Also, make sure that the total rating of all products plugged into the wall outlet does not exceed the fuse rating.
- Do not overload a power outlet, strip or receptacle by plugging in too many devices. The overall system load must not exceed 80% of the branch circuit rating. If power strips are used, the load should not exceed 80% of the power strip's input rating.
- This product's AC adapter is equipped with a three-wire grounded plug. The plug only fits in a grounded power outlet. Make sure the power outlet is properly grounded before inserting the AC adapter plug. Do not insert the plug into a non-grounded power outlet. Contact your electrician for details.

 **Warning!** The grounding pin is a safety feature. Using a power outlet that is not properly grounded may result in electric shock and/or injury.

Note: *The grounding pin also provides good protection from unexpected noise produced by other nearby electrical devices that may interfere with the performance of this product.*

- Use the product only with the supplied power supply cord set. If you need to replace the power cord set, make sure that the new power cord meets the following requirements: detachable type, UL listed/CSA certified, VDE approved or its equivalent, 4.5 meters (15 feet) maximum length.

Product servicing

Do not attempt to service this product yourself, as opening or removing covers may expose you to dangerous voltage points or other risks. Refer all servicing to qualified service personnel.

Unplug this product from the wall outlet and refer servicing to qualified service personnel when:

- the power cord or plug is damaged, cut or frayed
- liquid was spilled into the product
- the product was exposed to rain or water
- the product has been dropped or the case has been damaged
- the product exhibits a distinct change in performance, indicating a need for service
- the product does not operate normally after following the operating instructions

Note: *Adjust only those controls that are covered by the operating instructions, since improper adjustment of other controls may result in damage and will often require extensive work by a qualified technician to restore the product to normal condition.*

 **Warning!** For safety reasons, do not use non-compliant parts when adding or changing components. Consult your reseller for purchase options.

Your device and its enhancements may contain small parts. Keep them out of the reach of small children.

Additional safety information

- Do not look into the projector's lens when the light is on. The bright may hurt your eyes.
- Turn on the projector first and then signal sources
- Do not place the product in following environments:
 - Space that is poorly ventilated or confined. At least 50cm clearance from walls and free flow of air around the projector is necessary.
 - Locations where temperatures may become excessively high, such as inside of a car with all windows rolled up.
 - Locations where excessive humidity, dust, or cigarette smoke may contaminate optical components, shortening the life span and darkening the image.
 - Locations near fire alarms.
 - Locations with an ambient temperature above 40°C / 104°F.
 - Locations where the altitudes are higher than 10000 feet.
- Unplug immediately if there is something wrong with your projector. Do not operate if smoke, strange noise or odor comes out of your projector. It might cause fire or electric shock. In this case, unplug immediately and contact your dealer.
- Do not keep using this product to break or drop it. In this case contact your dealer for inspection.
- Do not face the projector lens to the sun. It can lead to fire.
- When switching the projector off, suggest to ensure the projector completes its cooling cycle before disconnecting power.
- Do not frequently turn off the main power abruptly or unplug the projector during operation. The best way is to wait for the fan to turn off before turning main power off.
- Do not touch air outlet grille and bottom plate which becomes hot.
- Do not look into the air outlet grille when projector is operating. It may hurt your eyes.
- Always open the lens shutter or remove the lens cap when the projector is on.
- Do not block the projector lens with any object when the projector is under operation as this could cause the object to become heated and deformed or even cause a fire.
- Do not attempt to disassemble this projector. There are dangerous high voltages inside which may hurt you. Refer servicing only to suitable qualified professional service personnel.
- Do not stand the projector on end vertically. It may cause the projector to fall over, causing injury or damage.
- 360° projection capability

Images can be projected over a full 360° range along the vertical axis, including reproduction on a ceiling or floor.

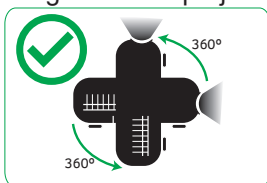

Note: *The brightness will be reduced 80% when the projection direction is downward.*

Portrait projection

Do not use the projector with it leaning to the left and right. This may result in a malfunction, however, portrait installation is possible.



Note:

- Please do not install the projector in a vertical orientation on the top of the floor or table on its own. The intake vent may be obstructed, resulting in the projector getting warm and the possibility of fire and malfunction occurring.
- When operating the projector in an enclosed space, allow at least 30 cm clearance around the intake and exhaust vents.

Caution for Listening

To protect your hearing, follow these instructions.

- Increase the volume gradually until you can hear clearly and comfortably.
- Do not increase the volume level after your ears have adjusted.
- Do not listen to music at high volumes for extended periods.
- Do not increase the volume to block out noisy surroundings.
- Decrease the volume if you can't hear people speaking near you.

Disposal instructions

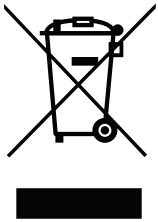

Do not throw this electronic device into the trash when discarding. To minimize pollution and ensure utmost protection of the global environment, please recycle. For more information on the Waste from Electrical and Electronics Equipment (WEEE) regulations, visit <http://www.acer-group.com/public/Sustainability/sustainability01.htm>

Do not stare into the beam

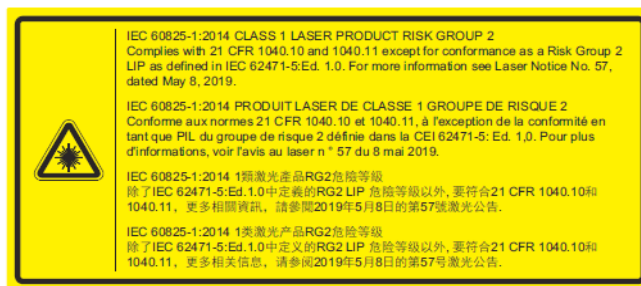

Do not stare into beam, RG2

As with any bright source, do not stare into the direct beam, RG2 IEC 62471-5:2015.

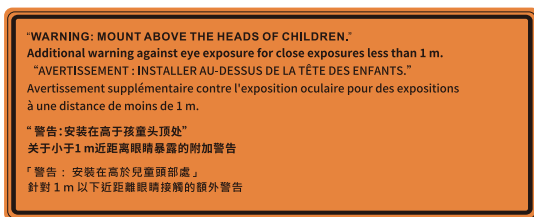

- Notice is given to supervise children and to never allow them to stare into the projector beam at any distance from the projector.
- Notice is given to use caution when using the remote control for starting the projector while in front of the projection lens
- Notice is given to the user to avoid the use of optical aids such as binoculars or telescopes inside the beam.

First things first

Usage Notes

Do:

- Turn off the product before cleaning.
- Use a soft cloth moistened with mild detergent to clean the displayhousing.
- Disconnect the power plug from AC outlet if the product is not being used for a long period of time.

Don't:

- Block the slots and openings on the unit provided for ventilation.
- Use abrasive cleaners, waxes or solvents to clean the unit.
- Use under the following conditions:
 - In extremely hot, cold or humid environments.
 - In areas susceptible to excessive dust and dirt.
 - Near any appliance that generates a strong magnetic field.
 - Place In direct sunlight.

Precautions

Follow all warnings, precautions and maintenance as recommended in this user's guide to maximize the life of your unit.

Warning!

- Do not look into the projector's lens when the light is on. The bright may hurt your eyes.
- To reduce the risk of fire or electric shock, do not expose this product to rain or moisture.
- Please do not open or disassemble the product as this may cause electric shock.
- When switching the projector off, please ensure the projector completes its cooling cycle before disconnecting power.
- Turn on the projector first and then the signal sources.
- Do not use lens cap when projector is in operation.

Cleaning the lens

- Before cleaning the lens, be sure to turn off the projector and unplug the power cord to allow it to completely cool down.
- Use a compressed air tank to remove the dust.
- Use a special cloth for cleaning lens and gently wipe the lens. Do not touch the lens with your fingers.
- Do not use alkaline/acid detergents or volatile solvents such as alcohol for cleaning lens. If the lens is damaged due to the cleaning process, it is not covered by the warranty.

 **Warning!** Do not use a spray containing flammable gases to remove dust or dirt from the lens. This may cause a fire due to excessive heat inside the projector.

 **Warning!** Do not clean the lens if the projector is warming up as this may cause the lens' surface film to peel off.

 **Warning!** Do not wipe or tap the lens with a hard object.

TABLE OF CONTENTS

| | |
|---|-----------|
| INTRODUCTION | 9 |
| <i>Package Overview.....</i> | 9 |
| <i>Standard accessories.....</i> | 9 |
| <i>Optional accessories.....</i> | 9 |
| <i>Product Overview.....</i> | 10 |
| <i>Connections.....</i> | 11 |
| <i>Keypad.....</i> | 12 |
| <i>Remote control.....</i> | 13 |
| SETUP AND INSTALLATION..... | 14 |
| <i>Installing the projector.....</i> | 14 |
| <i>Connecting sources to the projector.....</i> | 17 |
| <i>Adjusting the projector image.....</i> | 19 |
| <i>Remote setup.....</i> | 20 |
| USING THE PROJECTOR | 22 |
| <i>Powering on / off the projector.....</i> | 22 |
| <i>Selecting an input source.....</i> | 23 |
| <i>Menu navigation and features.....</i> | 24 |
| <i>OSD Menu tree.....</i> | 25 |
| <i>Display image settings menu.....</i> | 32 |
| <i>Display 3D menu.....</i> | 34 |
| <i>Display aspect ratio menu.....</i> | 35 |
| <i>Display edge mask menu.....</i> | 38 |
| <i>Display zoom menu.....</i> | 38 |
| <i>Display image shift menu.....</i> | 38 |
| <i>Display geometric correction menu.....</i> | 38 |
| <i>Audio mute menu.....</i> | 39 |
| <i>Audio volume menu.....</i> | 39 |
| <i>Setup projection menu.....</i> | 40 |
| <i>Setup screen type menu.....</i> | 40 |
| <i>Setup power settings menu.....</i> | 40 |
| <i>Setup security menu.....</i> | 40 |
| <i>Setup HDMI Link settings menu.....</i> | 41 |
| <i>Setup test pattern menu.....</i> | 41 |
| <i>Setup options menu.....</i> | 42 |
| <i>Screen capture by PC tool.....</i> | 42 |
| <i>Setup reset OSD menu.....</i> | 43 |
| <i>Network LAN menu.....</i> | 44 |
| <i>Network control menu.....</i> | 45 |
| <i>Setup network control settings menu.....</i> | 46 |
| <i>Info menu.....</i> | 51 |

ADDITIONAL INFORMATION..... 52

Compatible resolutions 52
Image size and projection distance 55
Projector dimensions and ceiling mount installation..... 61
Troubleshooting 62
Warning indicators..... 63
Specifications 65

INTRODUCTION

Package Overview

Carefully unpack and verify that you have the items listed below under standard accessories. Some of the items under optional accessories may not be available depending on the model, specification and your region of purchase. Please check with your place of purchase. Some accessories may vary from region to region.

The warranty card is only supplied in some specific regions. Please consult your dealer for detailed information.

Standard accessories

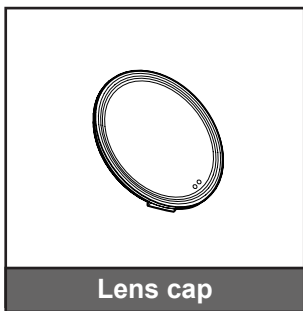
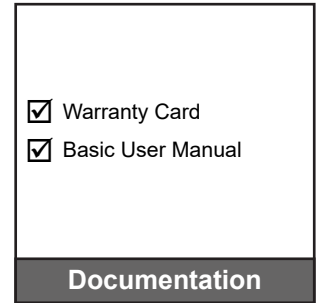
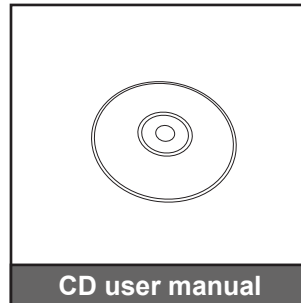
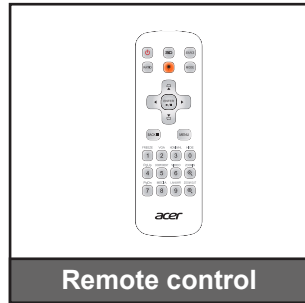
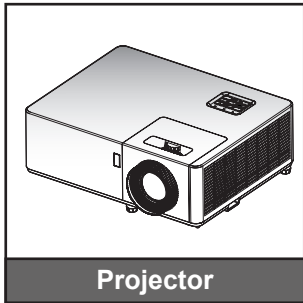

Optional accessories

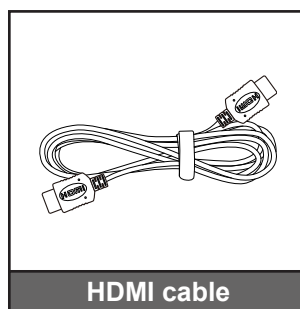
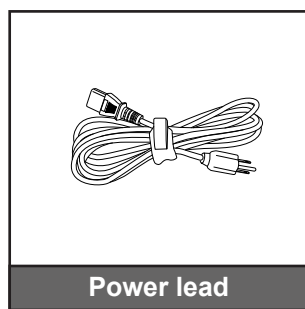
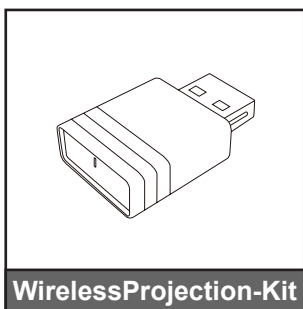

Note:

- *Optional accessories vary depending on model, specification and region.*

INTRODUCTION

Product Overview

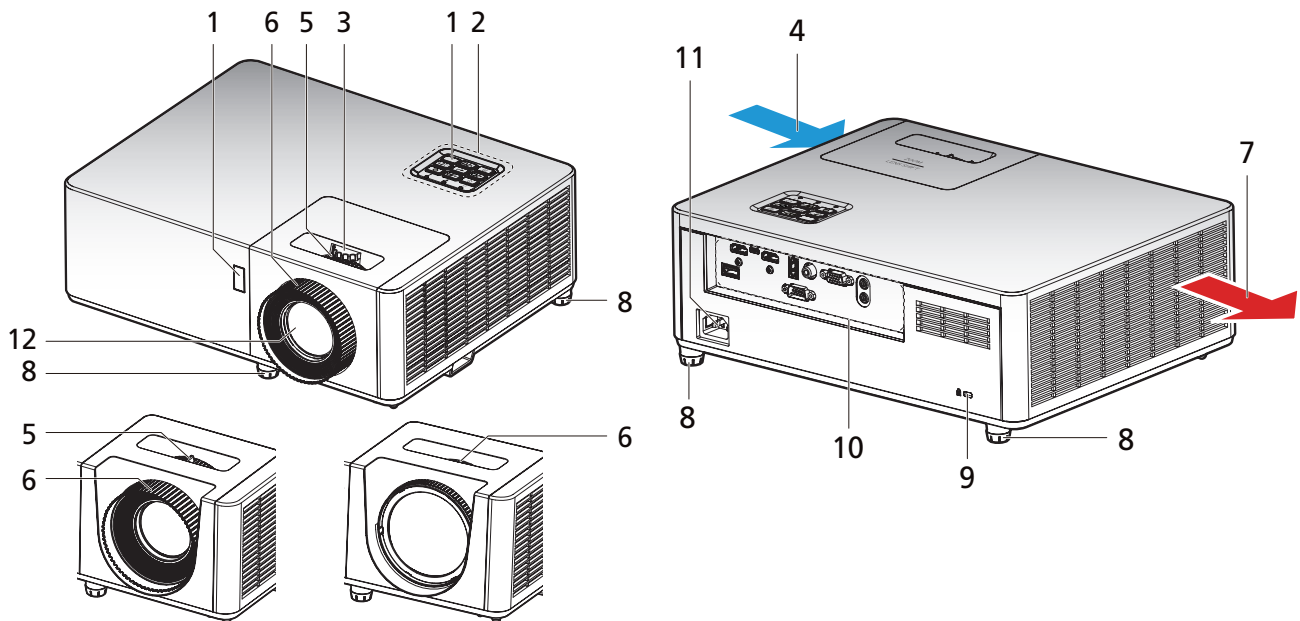

Note:

- Do not block projector intake and exhaust vents.
- When operating the projector in an enclosed space, allow at least 30 cm clearance around the intake and exhaust vents.
- Functions vary depending on model definition.

| No. | Item | No. | Item |
|-----|---------------------|-----|-----------------------|
| 1. | IR Receivers | 7. | Ventilation (outlet) |
| 2. | Keypad | 8. | Tilt-Adjustment Feet |
| 3. | Lens Shift Dial | 9. | Kensington™ Lock Port |
| 4. | Ventilation (inlet) | 10. | Input / Output |
| 5. | Zoom Lever | 11. | Power Socket |
| 6. | Focus Ring | 12. | Lens |

INTRODUCTION

Connections

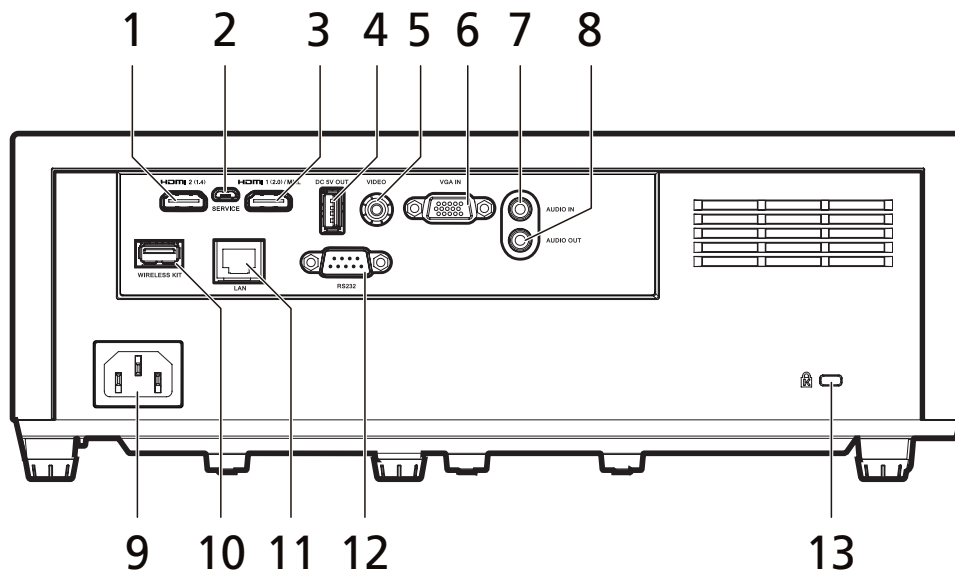

| No. | Item |
|-----|--|
| 1. | HDMI 2 (v1.4) Connector |
| 2. | Service connector (for firmware upgrade) |
| 3. | HDMI 1 (v2.0) / MHL Connector |
| 4. | USB Power Out (5V---1.5A) Connector |
| 5. | Composite Connector |
| 6. | VGA In Connector |
| 7. | Audio In Connector |
| 8. | Audio Out Connector |
| 9. | Power Socket |
| 10. | USB connector (for wifi dongle) |
| 11. | RJ-45 Connector |
| 12. | RS232 Connector |
| 13. | Kensington™ Lock Port |

Note: Functions vary depending on model definition.

INTRODUCTION

Keypad

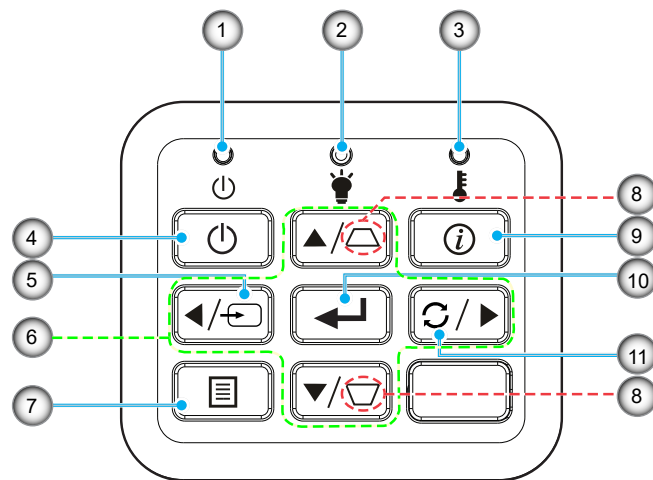

| No. | Item | No. | Item |
|-----|------------------------------|-----|---------------------|
| 1. | Power LED | 7. | Menu |
| 2. | Lamp LED | 8. | Keystone Correction |
| 3. | Temp LED | 9. | Information |
| 4. | Power | 10. | Enter |
| 5. | Source | 11. | Re-Sync |
| 6. | Four directional select keys | | |

INTRODUCTION

Remote control

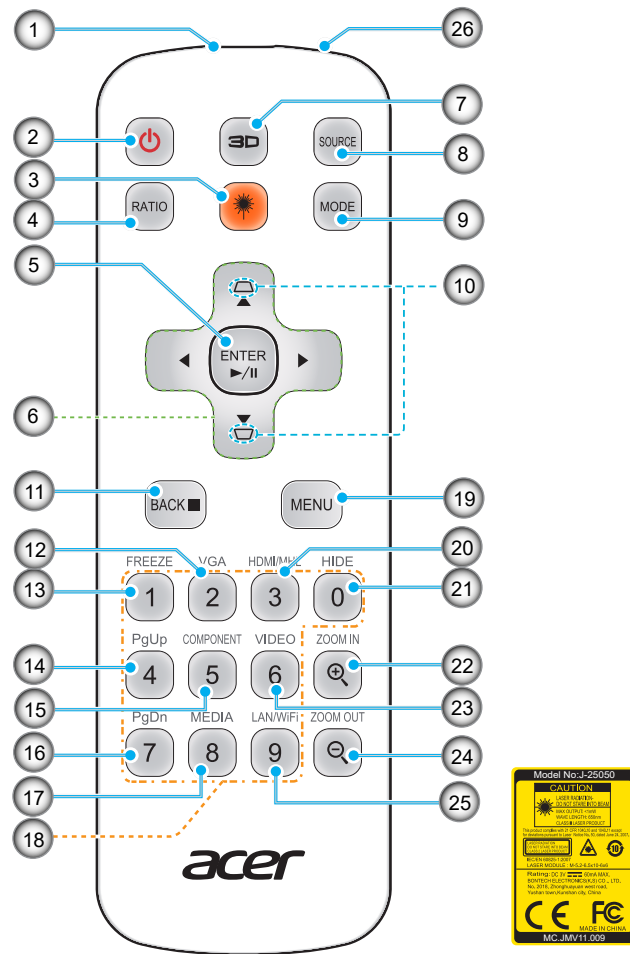

| No. | Item | No. | Item |
|-----|------------------------------|-----|---------------------------|
| 1. | Infrared transmitter | 14. | PgUp (not supported) |
| 2. | POWER | 15. | COMPONENT (not supported) |
| 3. | Laser button | 16. | PgDn (not supported) |
| 4. | RATIO | 17. | MEDIA (not supported) |
| 5. | Select/Enter Play/Pause | 18. | KeyPad 0~9 |
| 6. | Four directional select keys | 19. | MENU |
| 7. | 3D | 20. | HDMI™/MHL |
| 8. | SOURCE | 21. | HIDE |
| 9. | MODE | 22. | ZOOM IN |
| 10. | KEYSTONE | 23. | VIDEO |
| 11. | BACK STOP | 24. | ZOOM OUT |
| 12. | VGA | 25. | LAN/WiFi |
| 13. | FREEZE | 26. | Laser pointer |

Note: Some keys may have no function for models that do not support these features.

INTRODUCTION

MHL (Mobile High-Definition Link) Control

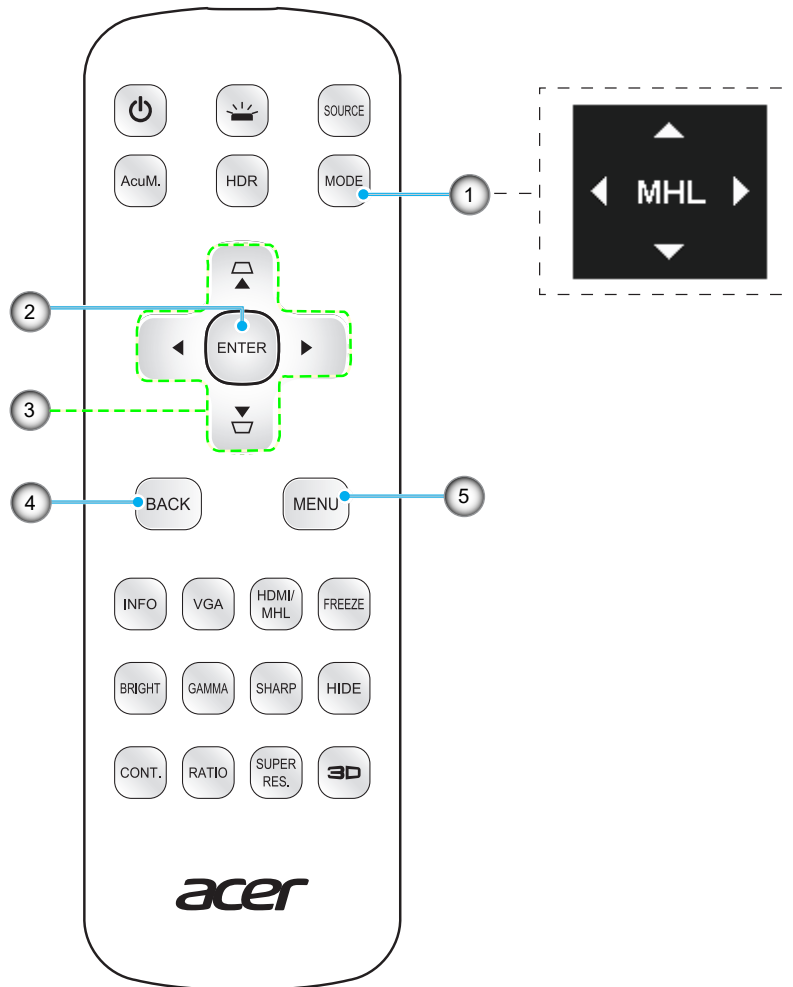

| No. | Item | Description |
|-----|------------------------------|--|
| 1. | MODE | <ul style="list-style-type: none">Press “MODE” button for one second to activate the MHL Control Mode.To exit, press the “MODE” button again. |
| 2. | Select/Enter | Press to select/enter the file. |
| 3. | Four directional select keys | Use up, down, left, right buttons to select items or make adjustments to your selection. |
| 4. | Back/Exit | <ul style="list-style-type: none">Press “BACK” to go back one menu step.To exit the file. |
| 5. | MENU | Press to launch the root menu. |

Note: Some keys may have no function for models that do not support these features.

SETUP AND INSTALLATION

Installing the projector

Your projector is designed to be installed in one of four possible positions.

Your room layout or personal preference will dictate which installation location you select. Take into consideration the size and position of your screen, the location of a suitable power outlet, as well as the location and distance between the projector and the rest of your equipment.

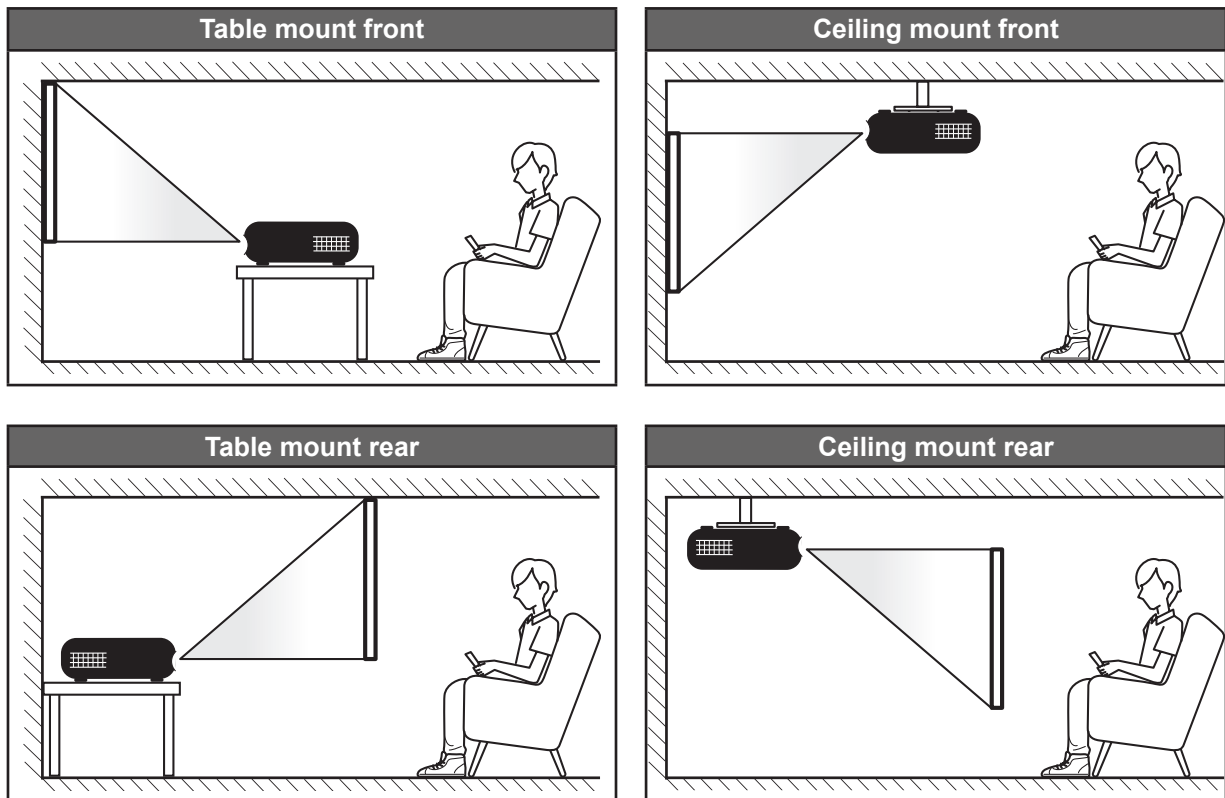

Projector should be placed flat on a surface and 90 degrees / perpendicular to the screen.

- How to determine projector location for a given screen size, please refer to distance table on pages 57-57.
- How to determine screen size for a given distance, please refer to distance table on pages 57-57.

Note: *The further away the projector is placed from the screen the projected image size increases and vertical offset also increases proportionally.*

IMPORTANT!

Do not operate the projector in any orientation other than table top or ceiling mount. The projector should be horizontal and not tilted either forwards/backwards or left/right. Any other orientation will invalidate the warranty and may shorten the lifetime of the projector light source or the projector itself. For non standard installation advise please contact Acer.

SETUP AND INSTALLATION

Projector installation notice

Note: The brightness will be reduced 80% when the projection direction is downward.

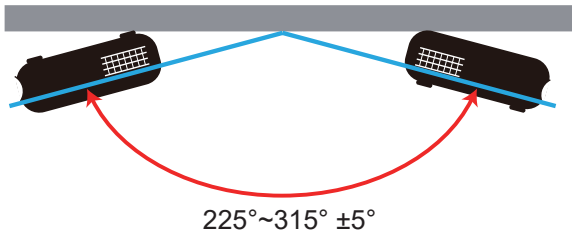

- Portrait mode

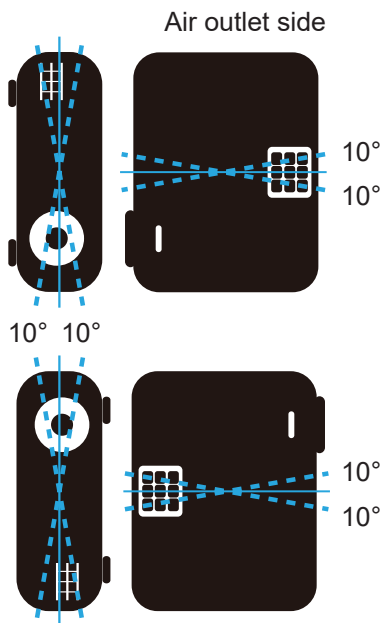

- Allow at least 30 cm clearance around the exhaust vent.

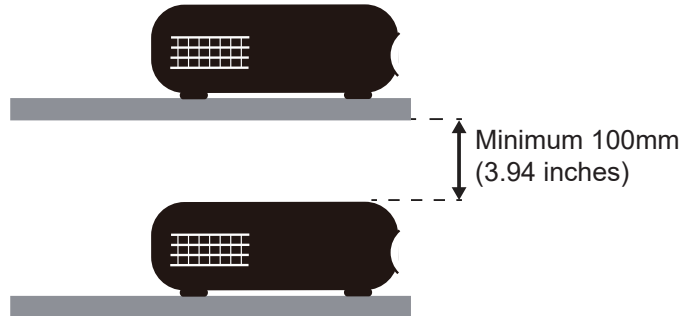
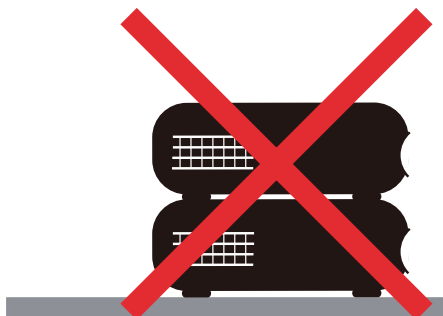
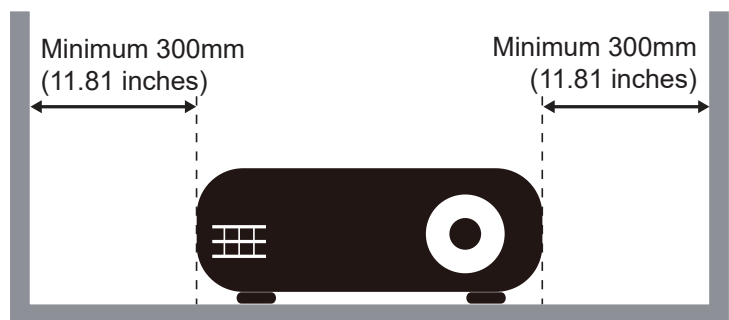
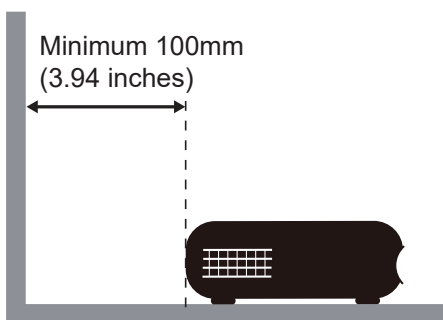

SETUP AND INSTALLATION

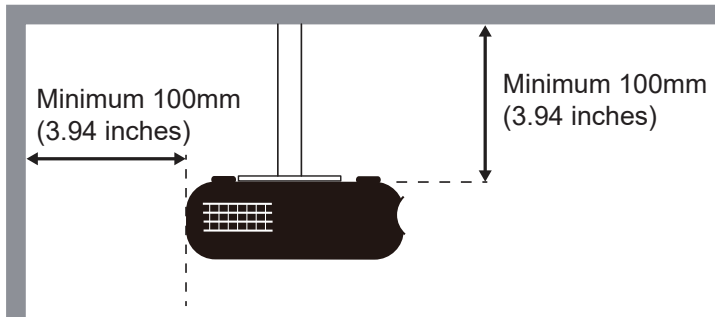

- Ensure that the intake vents do not recycle hot air from the exhaust vent.
- When operating the projector in an enclosed space, ensure that the surrounding air temperature within the enclosure does not exceed operation temperature while the projector is running, and the air intake and exhaust vents are unobstructed.
- All enclosures should pass a certified thermal evaluation to ensure that the projector does not recycle exhaust air, as this may cause the device to shutdown even if the enclosure temperature is within the acceptable operation temperature range.

SETUP AND INSTALLATION

Connecting sources to the projector

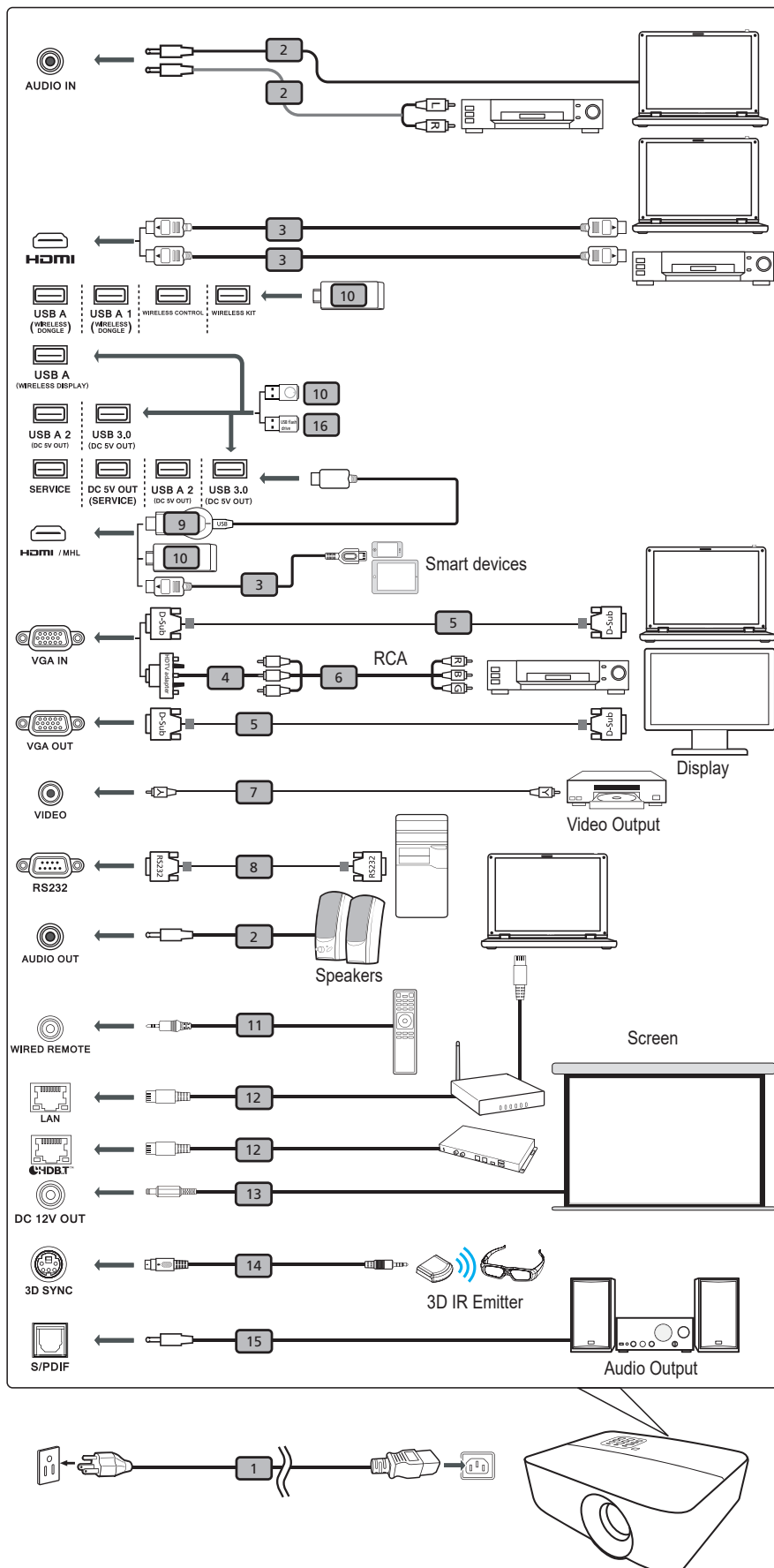

SETUP AND INSTALLATION

| # | Description |
|----|-------------------------------|
| 1 | Power cord |
| 2 | Audio cable |
| 3 | HDMI (MHL) cable |
| 4 | VGA to component/HDTV adapter |
| 5 | VGA cable |
| 6 | 3 RCA component cable |
| 7 | Composite video cable |
| 8 | RS232 cable |
| 9 | WirelessHD dongle |
| 10 | Wireless dongle |
| 11 | Wireless remote control |
| 12 | LAN cable |
| 13 | 12V DC cable |
| 14 | 3D SYNC cable |
| 15 | SPDIF cable |
| 16 | USB flash drive |

Note:

- *To ensure the projector works well with your computer, please make sure the timing of the display mode is compatible with the projector.*
- *Functions vary depending on model definition.*
- *USB cable needs powered extender if the length is over 5 m.*
- *USB DC 5V out connector support 5V power output for HDMI dongle charging.*
- *DC 12V out connector support 12V/100mA power for screen control only.*

SETUP AND INSTALLATION

Adjusting the projector image

Image height

The projector is equipped with elevator feet for adjusting the image height.

1. Locate the adjustable foot you wish to adjust on the underside of the projector.
2. Rotate the adjustable foot clockwise or counterclockwise to raise or lower the projector.

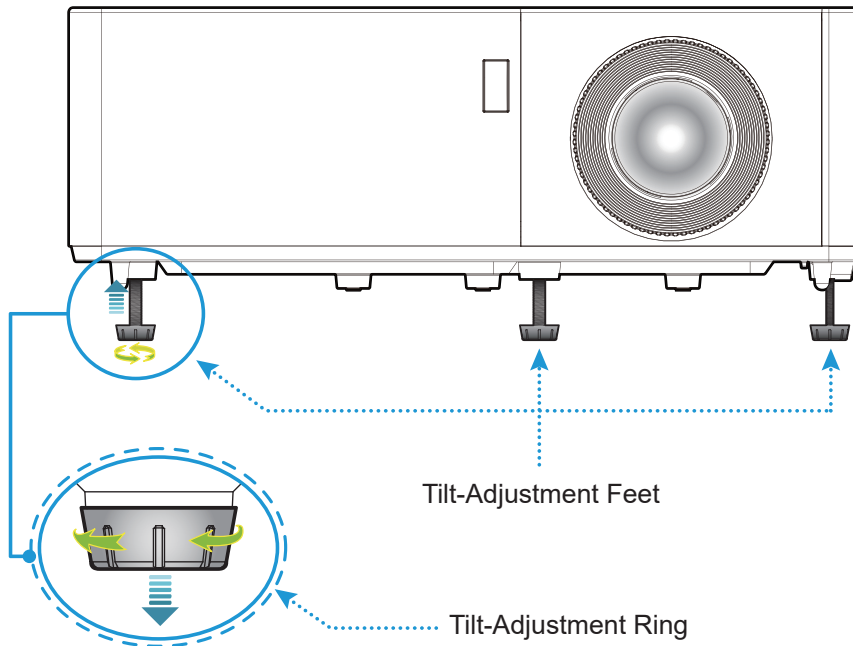

Zoom, lens shift, and focus

- To adjust the image size, turn the zoom lever clockwise or counterclockwise to increase or decrease the projected image size.
- To adjust the image position, turn the lens shift dial clockwise or counterclockwise to adjust the position of the projected image vertically.
- To adjust the focus, turn the focus ring clockwise or counterclockwise until the image is sharp and legible.

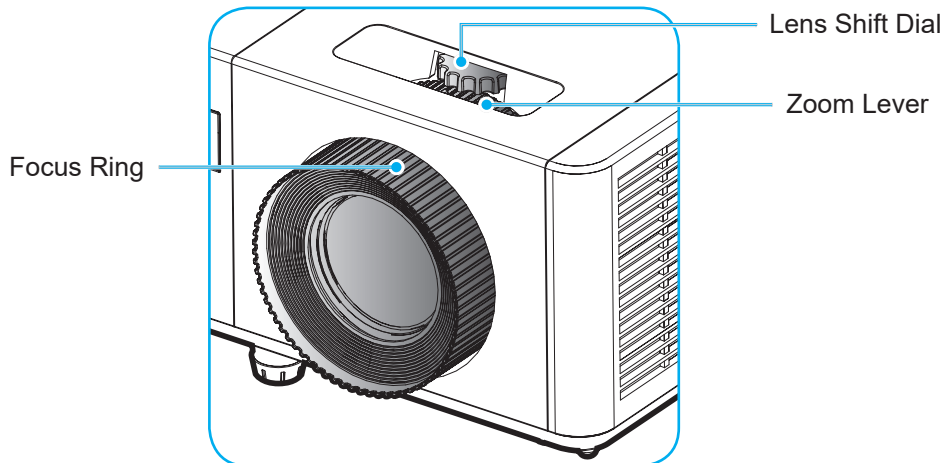

Note: Ensure that the projection screen is within the required distance from the projector. Please refer to "Image size and projection distance" for more information.

SETUP AND INSTALLATION

Remote setup

Installing / replacing the batteries

Two AAA size batteries are supplied for the remote control.

1. Remove the battery cover on the back of the remote control.
2. Insert AAA batteries in the battery compartment as illustrated.
3. Replace back cover on remote control.

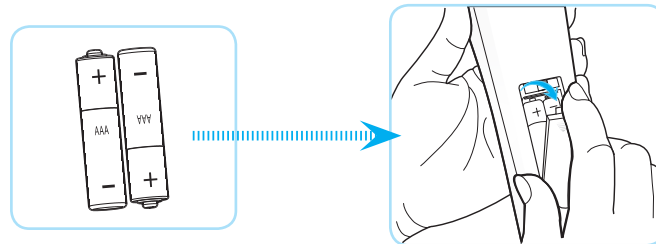

Note: Replace only with the same or equivalent type batteries.

CAUTION

Improper use of batteries can result in chemical leakage or explosion. Be sure to follow the instructions below.

- Do not mix batteries of different types. Different types of batteries have different characteristics.
- Do not mix old and new batteries. Mixing old and new batteries can shorten the life of new batteries or cause chemical leakage in old batteries.
- Remove batteries as soon as they are depleted. Chemicals that leak from batteries that come in contact with skin can cause a rash. If you find any chemical leakage, wipe thoroughly with a cloth.
- The batteries supplied with this product may have a shorter life expectancy due to storage conditions.
- If you will not be using the remote control for an extended period of time, remove the batteries.
- When you dispose of the batteries, you must obey the law in the relative area or country.

SETUP AND INSTALLATION

Effective range

Infra-Red (IR) remote control sensor is located on the top and front sides of the projector. Ensure to hold the remote control at an angle within 40 degrees perpendicular to the projector's IR remote control sensor to function correctly. The distance between the remote control and the sensor should not be longer than 5 meters (16.4 feet).

- Make sure that there are no obstacles between the remote control and the IR sensor on the projector that might obstruct the infra-red beam.
- Make sure the IR transmitter of the remote control is not being shined by sunlight or fluorescent lamps directly.
- Please keep the remote controller away from fluorescent lamps for over 2 m or the remote controller might become malfunction.
- If the remote control is close to Inverter-Type fluorescent lamps, it might become ineffective from time to time.
- If the remote control and the projector are within a very short distance, the remote control might become ineffective.
- When you aim at the screen, the effective distance is less than 5 m from the remote control to the screen and reflecting the IR beams back to the projector. However, the effective range might change according to screens.

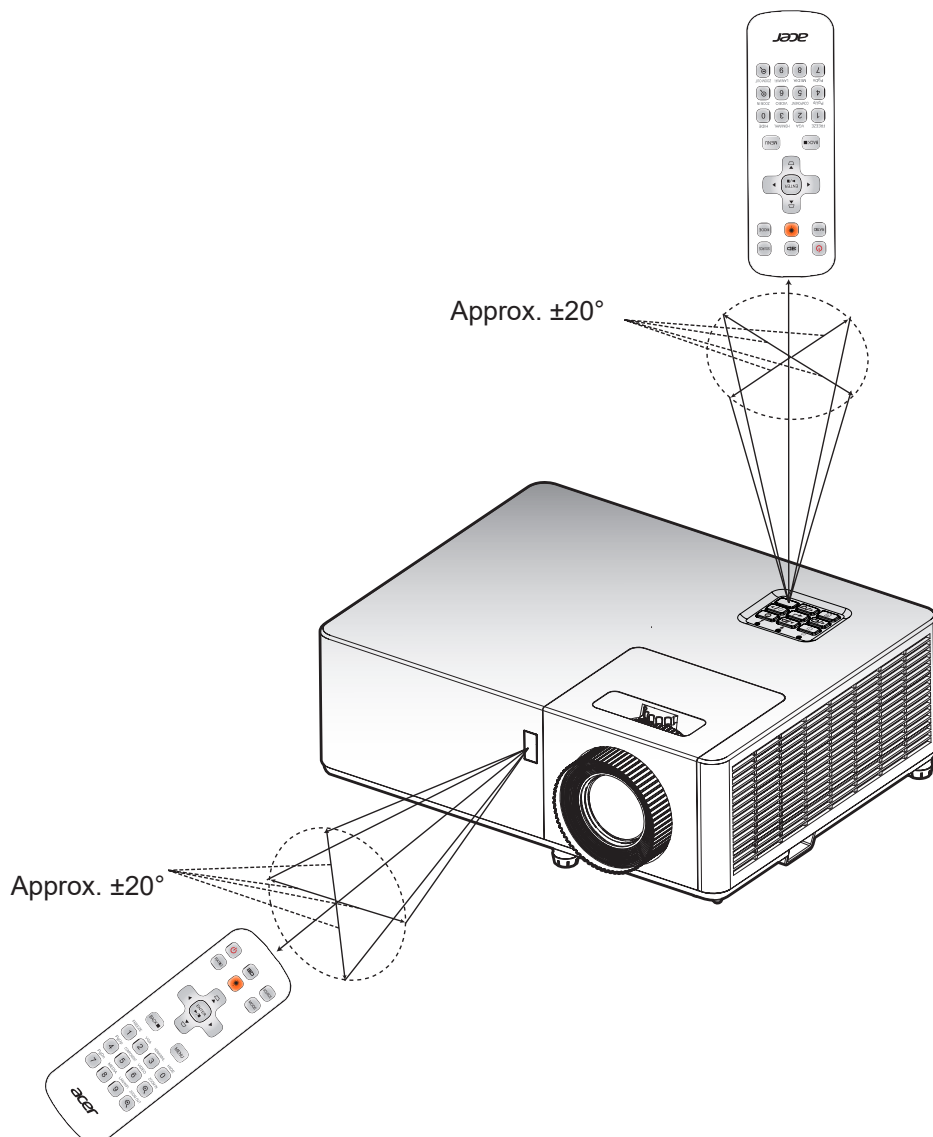

USING THE PROJECTOR

Powering on / off the projector

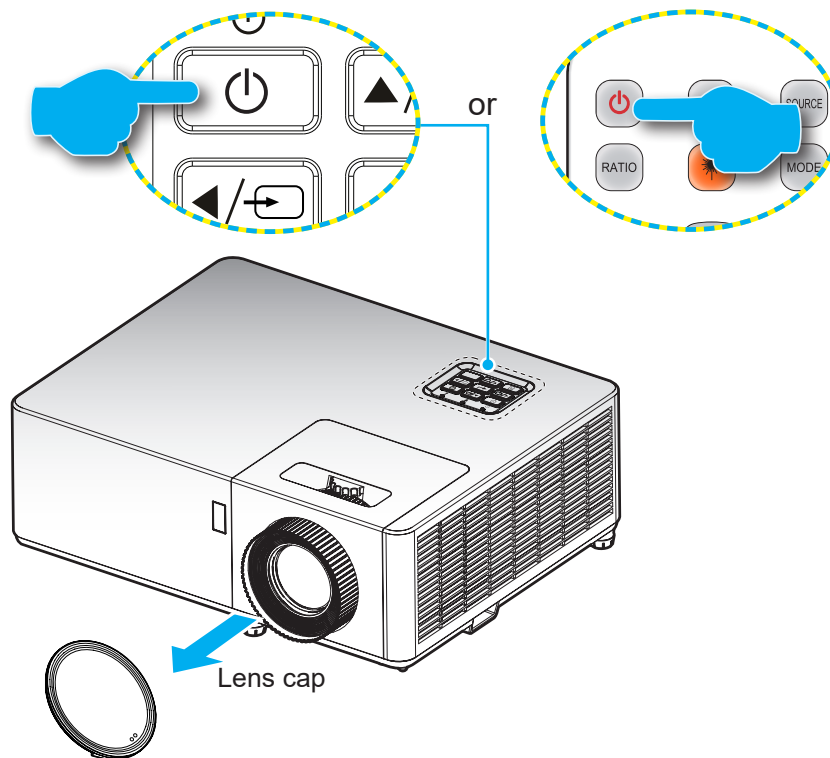

Powering on

1. Remove the lens cap.
2. Securely connect the power lead and signal/source cable. When connected, the Power LED will turn red.
3. Turn on the projector by pressing the \cup button on the projector keypad or remote control.
4. A start up screen will display in approximately 10 seconds and the Power LED will turn blue.

Note: The first time the projector is turned on, you will be prompted to select the preferred language, projection orientation, and other settings.

Powering off

1. Turn off the projector by pressing the \cup button on the projector keypad or remote control.
2. The following message will be displayed:

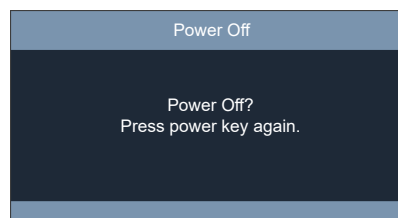

3. Press the \cup button again to confirm, otherwise the message will disappear after 10 seconds. When you press the \cup button for the second time, the projector will shut down.
4. When the Power turns solid red, this indicates the projector has entered standby mode. If you wish to turn the projector back on, you must wait until the cooling cycle has finished and the projector has entered standby mode. When the projector is in standby mode, simply press the \cup button again to turn on the projector.
5. Disconnect the power lead from the electrical outlet and the projector.

Note: It is not recommended that the projector is turned on immediately, right after a power off procedure.

USING THE PROJECTOR

Selecting an input source

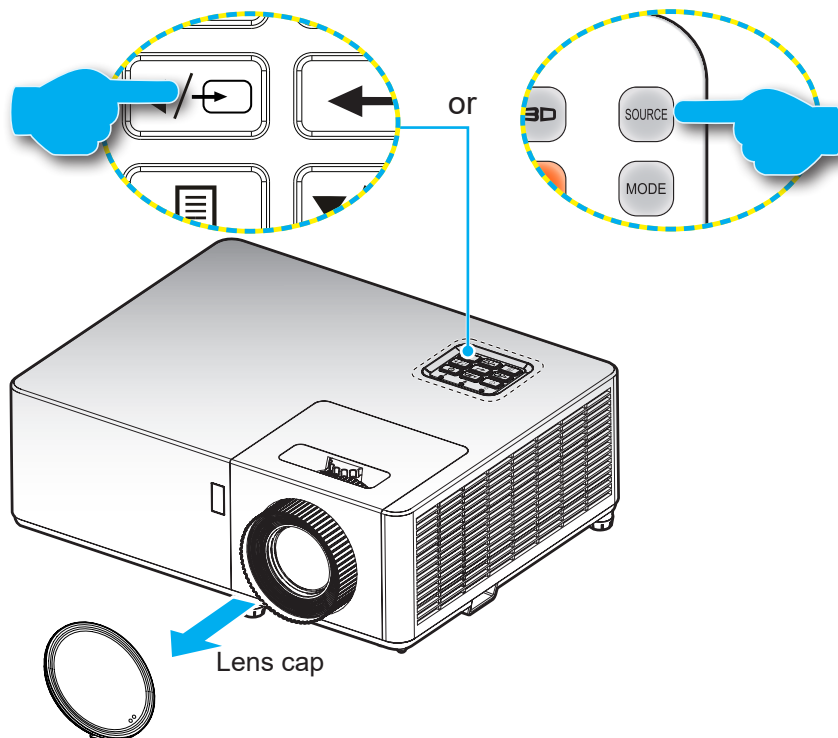

Turn on the connected source that you want to display on the screen, such as computer, notebook, video player, etc. The projector will automatically detect the source. If multiple sources are connected, press the  button on the projector keypad or the **Source** button on the remote control to select the desired input.



USING THE PROJECTOR

Menu navigation and features

The projector has multilingual on-screen display menus that allow you to make image adjustments and change a variety of settings. The projector will automatically detect the source.

1. To open the OSD menu, press the  button on the projector keypad or the **Menu** button on the remote control.
2. When OSD is displayed, use **▲▼** keys to select any item in the main menu. While making a selection on a particular page, press the **←** button on the projector keypad or the **Enter** button on the remote control to enter sub menu.
3. Use **◀▶** keys to select the desired item in the sub menu and then press the **←** or **Enter** button to view further settings. Adjust the settings by using **◀▶** keys.
4. Select the next item to be adjusted in the sub menu and adjust as described above.
5. Press press the **←** or **Enter** button to confirm, and the screen will return to the main menu.
6. To exit, press the  or **Menu** button again. The OSD menu will close and the projector will automatically save the new settings.

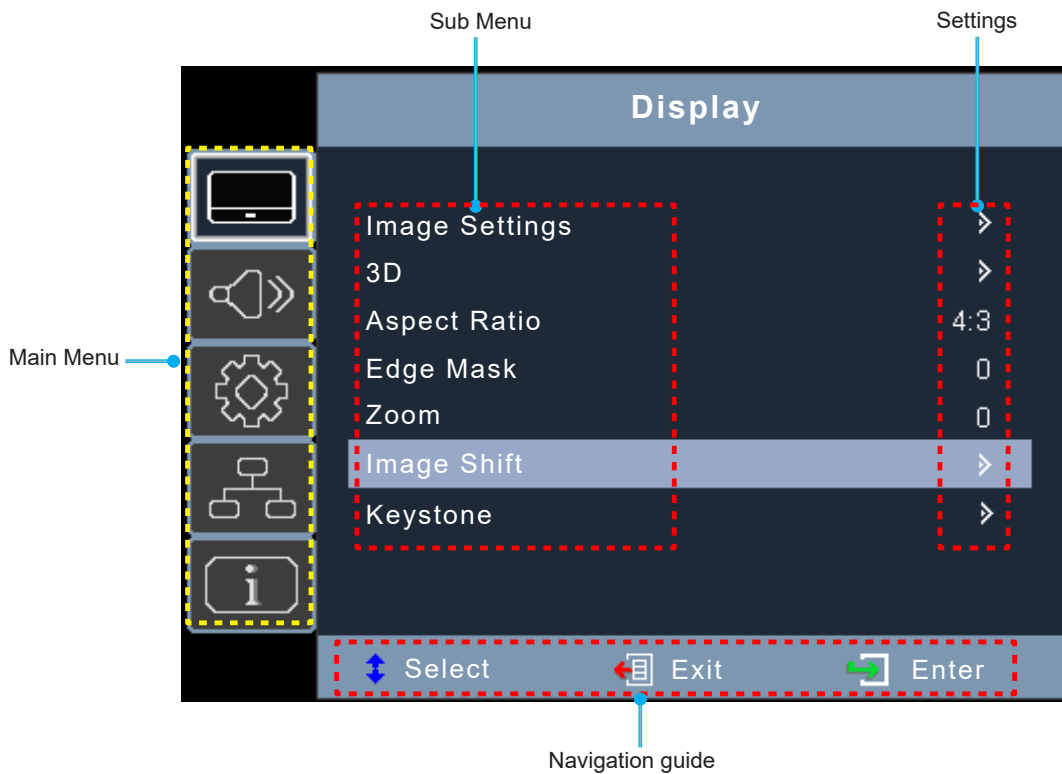

USING THE PROJECTOR



OSD Menu tree

| Main Menu | Sub Menu | Sub Menu 2 | Sub Menu 3 | Sub Menu 4 | Values | |
|-----------|----------------|-------------------|------------|---------------|--------------|---------------|
| Display | Image Settings | Display Mode | | | Presentation | |
| | | | | | Bright | |
| | | | | | HDR SIM. | |
| | | | | | HLG SIM. | |
| | | | | | Cinema | |
| | | | | | Game | |
| | | | | | sRGB | |
| | | | | | DICOM SIM. | |
| | | | | | User | |
| | | | | 3D | | |
| | | | Wall Color | | | Off [Default] |
| | | | | | | Blackboard |
| | | | | | | Light Yellow |
| | | | | | | Light Green |
| | | | | | | Light Blue |
| | | | | | | Pink |
| | | | | | Gray | |
| | | | Brightness | | | -50 ~ 50 |
| | | | Contrast | | | -50 ~ 50 |
| | | | Sharpness | | | 1 ~ 15 |
| | | | Color | | | -50 ~ 50 |
| | | | Tint | | | -50 ~ 50 |
| | | | Gamma | Film | | |
| | | | | Video | | |
| | | | | Graphics | | |
| | | | | Standard(2.2) | | |
| | | | | 1.8 | | |
| | | | | 2.0 | | |
| | | | | 2.4 | | |
| | | | 2.6 | | | |
| | Color Settings | BrilliantColor™ | | 1 ~ 10 | | |
| | | Color Temperature | | Warm | | |
| | | | | Standard | | |
| | | | | Cool | | |
| | | | | Cold | | |





USING THE PROJECTOR

| Main Menu | Sub Menu | Sub Menu 2 | Sub Menu 3 | Sub Menu 4 | Values |
|-----------|----------------|------------------------------|----------------|--|---|
| Display | Image Settings | Color Settings | Color Matching | Color | Red [Default] |
| | | | | | Green |
| | | | | | Blue |
| | | | | | Cyan |
| | | | | | Yellow |
| | | | | | Magenta |
| | | | | | White(*) |
| | | | | Hue / R(*) | -50 ~ 50 [Default: 0] |
| | | | | Saturation / G(*) | -50 ~ 50 [Default: 0] |
| | | | | Gain / B(*) | -50 ~ 50 [Default: 0] |
| | | | Reset | Cancel [Default] | |
| | | | | Yes | |
| | | | Exit | | |
| | | | RGB Gain/Bias | Red Gain | -50 ~ 50 |
| | | | | Green Gain | -50 ~ 50 |
| | | | | Blue Gain | -50 ~ 50 |
| | | | | Red Bias | -50 ~ 50 |
| | | | | Green Bias | -50 ~ 50 |
| | | | | Blue Bias | -50 ~ 50 |
| | | | | Reset | Cancel [Default] |
| | | | | Yes | |
| | | Exit | | | |
| | | Color Space [Not HDMI Input] | | Auto [Default] | |
| | | | | RGB | |
| | | | | YUV | |
| | | Color Space [HDMI Input] | | Auto [Default] | |
| | | | | RGB(0~255) | |
| | | | | RGB(16~235) | |
| | | | | YUV | |
| | | Signal | Automatic | | Off |
| | | | | | On [Default] |
| | | | Frequency | | -10 ~ 10 (depends on signal) [Default: 0] |
| | | | Phase | | 0~31 (depends on signal) [Default: 0] |
| | | | H. Position | | -5 ~ 5 (depends on signal) [Default: 0] |
| | | V. Position | | -5 ~ 5 (depends on signal) [Default: 0] | |
| | | Brightness Mode | | | DynamicBlack |
| | | | | | Eco. |
| | | | | | Power (Power = 100%/ 95%/ 90%/ 85%/ 80%/ 75%/ 70%/ 65%/ 60%/ 55%/ 50%) |
| | | Reset | | | |

USING THE PROJECTOR

| Main Menu | Sub Menu | Sub Menu 2 | Sub Menu 3 | Sub Menu 4 | Values |
|---------------|----------------------|---|------------|---------------------------------|-------------------------|
| Display | 3D | 3D Mode | | | Off [Default] |
| | | | | | On |
| | | 3D → 2D | | | 3D [Default] |
| | | | | | L |
| | | | | | R |
| | | | | | |
| | | 3D Format | | | Auto [Default] |
| | | | | | SBS |
| | | | | | Top and Bottom |
| | | | | | Frame Sequential |
| | 3D Sync Invert | | | On | |
| | | | | Off [Default] | |
| | Aspect Ratio | | | 4:3 | |
| | | | | 16:9 | |
| | | | | 16:10 | |
| | | | | LBX | |
| | | | | Native | |
| | | | | Auto [Default] | |
| | Edge Mask | | | 0 ~ 10 [Default: 0] | |
| | Zoom | | | -5 ~ 25 | |
| | Image Shift | H  | | | -100 ~ 100 [Default: 0] |
| | | V  | | | -100 ~ 100 [Default: 0] |
| | Geometric Correction | Four Corners | | | |
| H Keystone | | | | -30 ~30 / -15 ~ 15 [Default: 0] | |
| V Keystone | | | | -30 ~30 / -15 ~ 15 [Default: 0] | |
| Auto Keystone | | | | Off | |
| Reset | | | | On [Default] | |
| Audio | Mute | | | Off [Default] | |
| | | | | On | |
| | Volume | | | 0 ~ 10 [Default: 5] | |

USING THE PROJECTOR

| Main Menu | Sub Menu | Sub Menu 2 | Sub Menu 3 | Sub Menu 4 | Values | |
|-----------|---------------------|-----------------------|------------|------------|---|--|
| Setup | Projection | | | | Front  [Default] | |
| | | | | | Rear  | |
| | | | | | Ceiling-top  | |
| | | | | | Rear-top  | |
| | Screen Type | | | | 16:9 | |
| | | | | | 16:10 [Default] | |
| | Power Settings | Direct Power On | | | | Off [Default] |
| | | | | | | On |
| | | Signal Power On | | | | Off [Default] |
| | | | | | | On |
| | | Auto Power Off (min.) | | | | 0 ~ 180 (5 min increments) [Default: 20] |
| | | Power Mode (Standby) | | | | Active |
| | | | | | Eco [Default] | |
| | USB Power (Standby) | | | | Off [Default] | |
| | | | | | On | |
| | Security | Security | | | | Off [Default] |
| | | | | | | On |
| | | Security Timer | Month | | | |
| | | | Day | | | |
| | | | Hour | | | |
| | Change Password | | | | [Default: 1234] | |
| | HDMI CEC | | | | | Off [Default] |
| | | | | | | On |
| | Test Pattern | | | | | Green Grid |
| | | | | | | Magenta Grid |
| | | | | | | White Grid |
| | | | | | White | |
| | | | | | Off [Default] | |

USING THE PROJECTOR

| Main Menu | Sub Menu | Sub Menu 2 | Sub Menu 3 | Sub Menu 4 | Values | | |
|-----------|--|------------|-------------------|------------------|-------------------|--|--|
| Setup | Options | Language | | | English [Default] | | |
| | | | | | Deutsch | | |
| | | | | | Français | | |
| | | | | | Italiano | | |
| | | | | | Español | | |
| | | | | | Português | | |
| | | | | | Polski | | |
| | | | | | Nederlands | | |
| | | | | | Svenska | | |
| | | | | | Norsk | | |
| | | | | | Suomi | | |
| | | | | | ελληνικά | | |
| | | | | | 繁體中文 | | |
| | | | | | 简体中文 | | |
| | | | | | 日本語 | | |
| | | | | | 한국어 | | |
| | | | | | Русский | | |
| | | | | | Magyar | | |
| | | | | | Čeština | | |
| | | | | | عربي | | |
| | | | | ไทย | | | |
| | | | | Türkçe | | | |
| | | | | فارسی | | | |
| | | | | Tiếng Việt | | | |
| | | | | Bahasa Indonesia | | | |
| | | | | Română | | | |
| | | | | Slovenčina | | | |
| | | | Closed Captioning | | | CC1 | |
| | | | | | | CC2 | |
| | | | | | | Off [Default] | |
| | | | Menu Settings | | Menu Location | | Top left  |
| | | | | | | Top right  | |
| | | | | | | Center  [Default] | |
| | Bottom left  | | | | | | |
| | Bottom right  | | | | | | |
| | Menu Timer | | | | Off | | |
| | | | | | 5sec | | |
| | | | | | 10sec [Default] | | |
| | Auto Source | | | | Off [Default] | | |
| | | | | | On | | |

USING THE PROJECTOR

| Main Menu | Sub Menu | Sub Menu 2 | Sub Menu 3 | Sub Menu 4 | Values |
|-----------|------------------|----------------------|--------------------------------------|--------------------------------------|---|
| Setup | Options | Input Source | | | HDMI 1/MHL [Default] |
| | | | | | HDMI 2 |
| | | | | | VGA IN |
| | | | | | Video |
| | | | | | Wireless Mirroring |
| | | High Altitude | | | Off [Default] |
| | | | | | On |
| | | Logo | | | Default [Default] |
| | | | | | Neutral |
| | | | | | User |
| | | Background Color | | | Black [Default] |
| | | | | | Blue |
| | | | | Red | |
| | | | | Green | |
| | | | Gray | | |
| Reset | Reset to Default | | | Cancel [Default] | |
| | | | | Yes | |
| Network | LAN | Network Status | | | (read only) |
| | | MAC Address | | | (read only) |
| | | DHCP | | | Off |
| | | | | | On [Default] |
| | | IP Address | | | |
| | | Subnet Mask | | | |
| | | Gateway | | | |
| | | DNS | | | |
| | Reset | | | | |
| | Control | Crestron | | | Off |
| | | | | | On [Default] Note: Port 41794 |
| | | Extron | | | Off |
| | | | | | On [Default] Note: Port 2023 |
| | | PJ Link | | | Off |
| | | | | | On [Default] Note: Port 4352 |
| | | AMX Device Discovery | | | Off |
| | | | | | On [Default] Note: Port 9131 |
| | | Telnet | | | Off |
| | | | | On [Default] Note: Port 23 | |
| HTTP | | | Off | | |
| | | | On [Default] Note: Port 80 | | |

USING THE PROJECTOR

| Main Menu | Sub Menu | Sub Menu 2 | Sub Menu 3 | Sub Menu 4 | Values | |
|-----------|----------------------|------------|------------|------------|--------|--|
| Info | Serial Number | | | | | |
| | Source | | | | | |
| | Resolution | | | | 00x00 | |
| | Refresh Rate | | | | 0.00Hz | |
| | Display Mode | | | | | |
| | Power Mode (Standby) | | | | | |
| | Light Source Hours | | | | 0 hr | |
| | Network Status | | | | | |
| | IP Address | | | | | |
| | Brightness Mode | | | | | |
| | FW Version | System | | | | |
| | | LAN | | | | |
| MCU | | | | | | |

Note: Functions vary depending on model definition.

USING THE PROJECTOR

Display menu

Display image settings menu

Note: Functions vary depending on model definition.

Display Mode

There are many factory presets optimized for various types of images.

- **Presentation:** This mode is suitable for showing in front of public in connection to the PC.
- **Bright:** Maximum brightness from PC input.
- **HDR SIM.:** Decodes and displays High Dynamic Range (HDR) content for the deepest blacks, brightest whites, and vivid cinematic color using REC.2020 color gamut. This mode can be selected to enhances non-HDR content with simulated High Dynamic Range (HDR).
- **HLG SIM.:** Decodes and displays Hybrid Log Gamma(HLG) content for the deepest blacks, brightest whites, and vivid cinematic color using REC.2100 color gamut. This mode can be selected to enhances non-HLG content with simulated Hybrid Log Gamma(HLG).
- **Cinema:** Provides the best colors for watching movies.
- **Game:** Select this mode to increase the brightness and response time level for enjoying video games.
- **sRGB:** Standardized accurate color.
- **DICOM SIM.:** This mode can project a monochrome medical image such as an X ray radiography, MRI, etc.
- **User:** Memorize user's settings.
- **3D:** To experience the 3D effect, you need to have 3D glasses, make sure your PC/portable device has a 120 Hz signal output quad buffered graphics card and have a 3D Player installed.

Wall Color

Use this function to obtain an optimized screen image according to the wall color. Select between off, blackboard, light yellow, light green, light blue, pink, and gray.

Brightness

Adjust the brightness of the image.

Contrast

The contrast controls the degree of difference between the lightest and darkest parts of the picture.

Sharpness

Adjust the sharpness of the image.

Color

Adjust a video image from black and white to fully saturated color.

Tint

Adjust the color balance of red and green.

Gamma

Set up gamma curve type. After the initial setup and fine tuning is completed, utilize the Gamma Adjustment steps to optimize your image output.

- **Film:** For home theater.
- **Video:** For video or TV source.
- **Graphics:** For PC / Photo source.
- **Standard(2.2):** For standardized setting.

USING THE PROJECTOR

- **1.8 / 2.0 / 2.4 / 2.6:** For specific PC / Photo source.

Note:

- *These options are only available if the 3D mode function is disabled, the **Wall Color** setting is not set to **Blackboard**, and the **Display Mode** setting is not set to **DICOM SIM.**, **HDR SIM.** or **HLG SIM.***
- *In 3D mode, user can only select **3D** for **Gamma** setting.*
- *If the **Wall Color** setting is set to **Blackboard**, user can only select **Blackboard** for **Gamma** setting.*
- *If the **Display Mode** setting is set to **DICOM SIM.**, user can only select **DICOM SIM.** for **Gamma** setting.*
- *If the **Display Mode** setting is set to **HDR SIM.** or **HLG SIM.**, user can only select **HDR SIM.** or **HLG SIM.** for **Gamma** setting.*

Color Settings

Configure the color settings.

- **BrilliantColor™:** This adjustable item utilizes a new color-processing algorithm and enhancements to enable higher brightness while providing true, more vibrant colors in picture.
- **Color Temperature:** Select a color temperature from Warm, Standard, Cool, or Cold.
- **Color Matching:** Select the following options:
 - **Color:** Adjust the red, green, black, cyan, yellow, magenta, and white level of the image.
 - **Hue / R(red)*:** Adjust the color balance of red and green.
Note: **If the **Color** setting is set to **White**, you can adjust the red color setting.*
 - **Saturation / G(green)*:** Adjust a video image from black and white to fully saturated color.
Note: **If the **Color** setting is set to **White**, you can adjust the green color setting.*
 - **Gain / B(blue)*:** Adjust the image brightness.
Note: **If the **Color** setting is set to **White**, you can adjust the blue color setting.*
 - **Reset:** Return the factory default settings for color matching.
 - **Exit:** Exit the “Color Matching” menu.
- **RGB Gain/Bias:** This settings allows to configure the brightness (gain) and contrast (bias) of an image.
 - **Reset:** Return the factory default settings for RGB gain/bias.
 - **Exit:** Exit the “RGB Gain/Bias” menu.
- **Color Space (non-HDMI input only):** Select an appropriate color matrix type from the following: AUTO, RGB, or YUV.
- **Color Space (HDMI input only):** select an appropriate color matrix type from the following: Auto, RGB(0-255), RGB(16-235), and YUV.

Signal

Adjust the signal options.

- **Automatic:** Configure automatically the signal (the frequency and phase items are grayed out). If automatic is disabled, the frequency and phase items will appear for tuning and saving the settings.
- **Frequency:** Change the display data frequency to match the frequency of your computer’s graphic card. Use this function only if the image appears to flicker vertically.
- **Phase:** Synchronize the signal timing of the display with the graphic card. If the image appears to be unstable or flickers, use this function to correct it.
- **H. Position:** Adjust the horizontal positioning of the image.
- **V. Position:** Adjust the vertical positioning of the image.

Note: *This menu is only available if the input source is RGB/Component.*

USING THE PROJECTOR

Brightness Mode

Adjust the brightness mode settings.

- **DynamicBlack:** Use to automatically adjust the picture brightness in order to give optimum contrast performance.
- **Eco.:** Choose “Eco.” to dim the projector lamp which will lower power consumption and extend the lamp life.
- **Power:** Choose the power percentage for brightness mode.

Reset

Return the factory default settings for color settings.

Display 3D menu

Note:

- *This projector is a 3D ready projector with DLP-Link 3D solution.*
- *Please make sure your 3D glasses are use for DLP-Link 3D before enjoy your video.*
- *This projector supports frame sequential (page-flip) 3D via HDMI/VGA ports.*
- *To enable 3D mode, the input frame rate should be set to 60Hz only, lower or higher frame rate is not supported.*
- *To reach the best performance, resolution 1920x1080 is recommended, please be noted that 4K (3840x2160) resolution is not supported in 3D mode.*

3D Mode

Use this option to disable the 3D function or select the appropriate the 3D function.

- **Off:** Select “Off” to turn off 3D mode.
- **On:** Select “On” to turn on 3D mode.

Note: *If the 2D and 3D sources enter projector at the same time, if the ghosting image appears in the 2D source, make sure to manually turn off the 3D function.*

3D → 2D

Use this option to specify how the 3D content should appear on the screen.

- **3D:** Display 3D signal.
- **L (Left):** Display the left frame of 3D content.
- **R (Right):** Display the right frame of 3D content.

3D Format

Use this option to select the appropriate 3D format content.

- **Auto:** When a 3D identification signal is detected, the 3D format is selected automatically.
- **SBS:** Display 3D signal in “Side-by-Side” format.
- **Top and Bottom:** Display 3D signal in “Top and Bottom” format.
- **Frame Sequential:** Display 3D signal in “Frame Sequential” format.

3D Sync Invert

Use this option to enable/disable the 3D sync invert function.

USING THE PROJECTOR

Display aspect ratio menu

Aspect Ratio

Select the aspect ratio of the displayed image between the following options:

- **4:3:** This format is for 4:3 input sources.
- **16:9:** This format is for 16:9 input sources, like HDTV and DVD enhanced for Wide screen TV.
- **16:10** (for WXGA/WUXGA model only): This format is for 16:10 input sources, like widescreen laptops.
- **LBX:** This format is for non-16x9, letterbox source and if you use external 16x9 lens to display 2.35:1 aspect ratio in full resolution.
- **Native:** This format displays the original image without any scaling.
- **Auto:** Automatically selects the appropriate display format.

Note:

- *Detailed informations about LBX mode:*
 - *Some Letter-Box Format DVDs are not enhanced for 16x9 TVs. In this situation, the image will not look right when displaying image in 16:9 mode. In this situation, please try to use the 4:3 mode to view the DVD. If the content is not 4:3, there will be black bars around the image in 16:9 display. For this type of content, you can use LBX mode to fill the image on the 16:9 display.*
 - *If you use an external anamorphic lens, this LBX mode also allows you to watch a 2.35:1 content (include Anamorphic DVD and HDTV film source) that supports anamorphic wide is enhanced for 16x9 Display in a wide 2.35:1 image. In this case, there are no black bars. Light source power and vertical resolution are fully utilized.*
- *To use the superwide format, do the following:*
 - a) *Set the screen aspect ratio to 2.0:1.*
 - b) *Select “Superwide” format.*
 - c) *Align the projector image correctly on the screen.*

XGA scaling table:

| 16:9 screen | 480i/p | 576i/p | 1080i/p | 720p | PC |
|-------------|--|--------|---------|------|----|
| 4x3 | Scale to 1024x768. | | | | |
| 16x9 | Scale to 1024x576. | | | | |
| Native | No scaling will be made; the image is displayed with the resolution based on input source. | | | | |
| Auto | - If source is 4:3, the screen type will be scaled to 1024 x 768. - If source is 16:9, the screen type will be scaled to 1024 x 576. - If source is 15:9, the screen type will be scaled to 1024 x 614. - If source is 16:10, the screen type will be scaled to 1024 x 640. | | | | |

XGA auto mapping rule:

| Auto | Input resolution | | Auto/Scale | |
|------|------------------|--------------|------------|-----|
| | H-resolution | V-resolution | 1024 | 768 |
| 4:3 | 640 | 480 | 1024 | 768 |
| | 800 | 600 | 1024 | 768 |
| | 1024 | 768 | 1024 | 768 |
| | 1600 | 1200 | 1024 | 768 |

USING THE PROJECTOR

| | | | | |
|-------------|------|------|------|-----|
| Wide Laptop | 1280 | 720 | 1024 | 576 |
| | 1280 | 768 | 1024 | 614 |
| | 1280 | 800 | 1024 | 640 |
| SDTV | 720 | 576 | 1024 | 576 |
| | 720 | 480 | 1024 | 576 |
| HDTV | 1280 | 720 | 1024 | 576 |
| | 1920 | 1080 | 1024 | 576 |

WXGA scaling table (screen type 16x10):

Note:

- Supported screen type 16:9 (1280x720), 16:10 (1280x800).
- When screen type is 16:9, the 16x10 format becomes unavailable.
- When screen type is 16:10, the 16x9 format becomes unavailable.
- If you select auto option then the display mode will be also automatically changed.

| 16 : 10 screen | 480i/p | 576i/p | 1080i/p | 720p | PC |
|----------------|---|--------|-------------------------------|--------------------|-----------------------|
| 4x3 | Scale to 1066x800. | | | | |
| 16x10 | Scale to 1280x800. | | | | |
| LBX | Scale to 1280x960, then get the central 1280x800 image to display. | | | | |
| Native mode | 1:1 mapping centered. | | 1:1 mapping display 1280x800. | 1280x720 centered. | 1:1 mapping centered. |
| Auto | -Input source will be fit into 1280x800 display area and be kept its original aspect ratio. -If source is 4:3, the screen type will be scaled to 1066x800. -If source is 16:9, the screen type will be scaled to 1280x720. -If source is 15:9, the screen type will be scaled to 1280x768. -If source is 16:10, the screen type will be scaled to 1280x800. | | | | |

WXGA auto mapping rule (screen type 16x10):

| Auto | Input resolution | | Auto/Scale | |
|-------------|------------------|--------------|------------|-----|
| | H-resolution | V-resolution | 1280 | 800 |
| 4:3 | 640 | 480 | 1066 | 800 |
| | 800 | 600 | 1066 | 800 |
| | 1024 | 768 | 1066 | 800 |
| | 1280 | 1024 | 1066 | 800 |
| | 1400 | 1050 | 1066 | 800 |
| | 1600 | 1200 | 1066 | 800 |
| Wide Laptop | 1280 | 720 | 1280 | 720 |
| | 1280 | 768 | 1280 | 768 |
| | 1280 | 800 | 1280 | 800 |
| SDTV | 720 | 576 | 1280 | 720 |
| | 720 | 480 | 1280 | 720 |
| HDTV | 1280 | 720 | 1280 | 720 |
| | 1920 | 1080 | 1280 | 720 |

USING THE PROJECTOR

WXGA scaling table (screen type 16x9):

| 16 : 9 screen | 480i/p | 576i/p | 1080i/p | 720p | PC |
|---------------|--|--------|----------------------------------|--------------------|----------------------|
| 4x3 | Scale to 960x720. | | | | |
| 16x9 | Scale to 1280x720. | | | | |
| LBX | Scale to 1280x960, then get the central 1280x720 image to display. | | | | |
| Native mode | 1:1 mapping centered. | | 1:1 mapping display 1280x720. | 1280x720 centered. | 1:1 mapping centred. |
| Auto | -If this format is select, screen type will automatically become 16:9 (1280x720). -If source is 4:3, the screen type will be scaled to 960x720. -If source is 16:9, the screen type will be scaled to 1280x720. -If source is 15:9, the screen type will be scaled to 1200x720. -If source is 16:10, the screen type will be scaled to 1152x720. | | | | |

WXGA auto mapping rule (screen type 16x9):

| Auto | Input resolution | | Auto/Scale | |
|-------------|------------------|--------------|------------|-----|
| | H-resolution | V-resolution | 1280 | 720 |
| 4:3 | 640 | 480 | 960 | 720 |
| | 800 | 600 | 960 | 720 |
| | 1024 | 768 | 960 | 720 |
| | 1280 | 1024 | 960 | 720 |
| | 1400 | 1050 | 960 | 720 |
| | 1600 | 1200 | 960 | 720 |
| Wide Laptop | 1280 | 720 | 1280 | 720 |
| | 1280 | 768 | 1200 | 720 |
| | 1280 | 800 | 1152 | 720 |
| SDTV | 720 | 576 | 1280 | 720 |
| | 720 | 480 | 1280 | 720 |
| HDTV | 1280 | 720 | 1280 | 720 |
| | 1920 | 1080 | 1280 | 720 |

1080p scaling table:

| 16:9 screen | 480i/p | 576i/p | 1080i/p | 720p | PC |
|-------------|---|--------|---------|------|----|
| 4x3 | Scale to 1440x1080. | | | | |
| 16x9 | Scale to 1920x1080. | | | | |
| LBX | Scale to 1920x1440, then get the central 1920x1080 image to display. | | | | |
| Native mode | - 1:1 mapping centered. - No scaling will be made; the image is displayed with the resolution based on input source. | | | | |
| Auto | - If auto format is selected, the screen type will automatically become 16:9 (1920x1080). - If source is 4:3, the screen type will be scaled to 1440 x1080. - If source is 16:9, the screen type will be scaled to 1920x1080. - If source is 16:10, the screen type will be scaled to 1920x1200 and cut 1920x1080 area to display. | | | | |

USING THE PROJECTOR

1080p auto mapping rule:

| Auto | Input resolution | | Auto/Scale | |
|-------------|------------------|--------------|------------|------|
| | H-resolution | V-resolution | 1920 | 1080 |
| 4:3 | 640 | 480 | 1440 | 1080 |
| | 800 | 600 | 1440 | 1080 |
| | 1024 | 768 | 1440 | 1080 |
| | 1280 | 1024 | 1440 | 1080 |
| | 1400 | 1050 | 1440 | 1080 |
| | 1600 | 1200 | 1440 | 1080 |
| Wide Laptop | 1280 | 720 | 1920 | 1080 |
| | 1280 | 768 | 1800 | 1080 |
| | 1280 | 800 | 1728 | 1080 |
| SDTV | 720 | 576 | 1350 | 1080 |
| | 720 | 480 | 1620 | 1080 |
| HDTV | 1280 | 720 | 1920 | 1080 |
| | 1920 | 1080 | 1920 | 1080 |

Display edge mask menu

Edge Mask

Use this function to remove the video encoding noise on the edge of video source.

Display zoom menu

Zoom

Use to reduce or magnify an image on the projection screen.

Display image shift menu

Image Shift

Adjust the projected image position horizontally (H) or vertically (V).

Display geometric correction menu

Four Corners

Allow the image to be squeezed to fit an area defined by moving each of the four corners' x and y position.

H Keystone

Adjust image distortion horizontally and make a squarer image. Horizontal keystone is used to correct a keystone image shape in which the left and right borders of the image are unequal in length. This is intended for use with horizontally on-axis applications.

V Keystone

Adjust image distortion vertically and make a squarer image. Vertical keystone is used to correct a keystone image shape in which the top and bottom are slanted to one of the sides. This is intended when for use with vertically on-axis applications.

Auto Keystone

Correct keystone digitally to fit the projected image on the area on which you are projecting.

USING THE PROJECTOR

Note:

- *The image size will reduce slightly when adjusting the horizontal and vertical keystone.*
- *When the Auto Keystone is used, the Four Corner Adjustment function will be disabled.*

Reset

Return the factory default settings for keystone settings.

Audio menu

Note: *Functions vary depending on model definition.*

Audio mute menu

Mute

Use this option to temporarily turn off the sound.

- **On:** Choose “On” to turn mute on.
- **Off:** Choose “Off” to turn mute off.

Note: *“Mute” function affects both internal and external speaker volume.*

Audio volume menu

Volume

Adjust the volume level.

USING THE PROJECTOR

Setup menu

Note: Functions vary depending on model definition.

Setup projection menu

Projection

Select the preferred projection between front, rear, ceiling-top, and rear-top.

Setup screen type menu

Screen Type (for WXGA/WUXGA model only)

Choose the screen type from 16:9 and 16:10.

Setup power settings menu

Direct Power On

Choose “On” to activate Direct Power mode. The projector will automatically power on when AC power is supplied, without pressing the “Power” key on the projector keypad or on the remote control.

Signal Power On

Choose “On” to activate Signal Power mode. The projector will automatically power on when a signal is detected, without pressing the “Power” key on the projector Keypad or on the remote control.

Note: Only supported on HDMI 1, HDMI 2 and VGA In Connector.

Auto Power Off (min.)

Sets the countdown timer interval. The countdown timer will start, when there is no signal being sent to the projector. The projector will automatically power off when the countdown has finished (in minutes).

Power Mode (Standby)

Set the power mode setting.

- **Active:** Choose “Active” to return to normal standby.
- **Eco:** Choose “Eco.” to save power dissipation further < 0.5W.

USB Power (Standby)

Enable or disable the USB power function when the projector is in standby mode.

Setup security menu

Security

Enable this function to prompt for a password before using the projector.

- **On:** Choose “On” to use security verification when the turning on the projector.
- **Off:** Choose “Off” to be able to switch on the projector without password verification.

Security Timer

Can be select the time (Month/Day/Hour) function to set the number of hours the projector can be used. Once this time has elapsed you will be requested to enter your password again.

Change Password

Use to set or modify the password that is prompted when turning the projector on.

Note: Password default value is “1234” (first time).

USING THE PROJECTOR

Setup HDMI Link settings menu

Note:

- When you connect HDMI CEC-compatible devices to the projector with HDMI cables, you can control them on the same power on or power off status using the HDMI Link control feature in the projector's OSD. This lets one device or multiple devices in a group power on or power off via HDMI Link Feature in a typical configuration, your DVD player may be connected to the projector through an amplifier or home theater system.

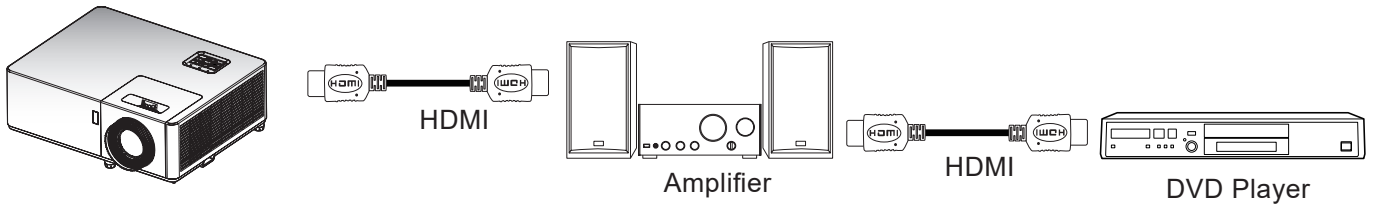

HDMI CEC

Default is Off. Select "On" to enable HDMI CEC function.

Setup test pattern menu

Test Pattern

Select the test pattern from green grid, magenta grid, white grid, white or disable this function (off).

USING THE PROJECTOR

Setup options menu

Language

Select the multilingual OSD menu.

Closed Captioning

Closed Captioning is a text version of the program sound or other information displayed on the screen. If the input signal contains closed captions, you can turn on the feature and watch the channels. The available options include "Off", "CC1", and "CC2".

Menu Settings

Set the menu location on the screen and configure menu timer settings.

- **Menu Location:** Select the menu location on the display screen.
- **Menu Timer:** Set the duration where the OSD menu stays visible on the screen.

Auto Source

Choose this option to let the projector automatically find an available input source.

Input Source

Select the input source between HDMI1, HDMI2, VGA IN, VIDEO and Wireless Mirroring.

High Altitude

When "On" is selected, the fans will spin faster. This feature is useful in high altitude areas where the air is thin.

Logo

Use this function to set the desired startup screen. If changes are made, they will take effect the next time the projector is powered on.

- **Default:** The default startup screen.
- **Neutral:** Logo is not displayed on startup screen.
- **User:** Use the stored picture as the startup screen.

Screen capture by PC tool

1. **Set "Logo" to "User"**
Set the "Logo" to "User" in **Setup** options menu.
2. **Enter download mode**
Hold both "Power" and "Menu" buttons and then plug in power cord. Release the buttons until Power/Lamp/Temp LED indicators are lighting red.
3. **Connect USB cable between PC and projector**
Please find the "SERVICE" USB port and plug-in USB cable.

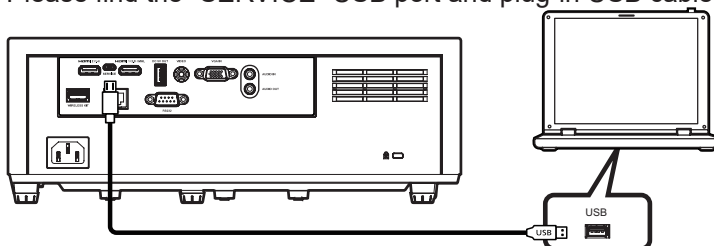

4. **Copy and Click Splash Downloader**
Copy the Acer_Splash_Downloader folder from the CD (User's Guide) to your computer, click the

USING THE PROJECTOR

Acer_Splash_Downloader.exe program, and follow the on-screen instructions. If the message says “Projector found”, the projector has been connected successfully.

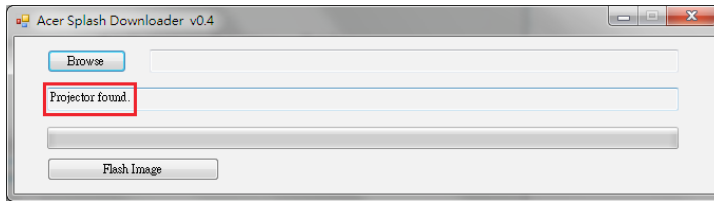

Note: If “Error: No Projector found.”, the projector is not connected. Please retry step 2 and step 3.

5. Select logo file

Click the “Browse” button and select logo file. The recommended resolution of logo should not exceed the default logo resolution (For example, logo resolution is 1920x1200). The purpose is that keeping the quality of the image. If not, the logo may be blurred.

Note: Support “PNG” & “BMP” file format.

6. Download logo to projector

Click the “Flash Image” button. If the file was written to projector successfully, the message “Download Complete” will be displayed on the screen.

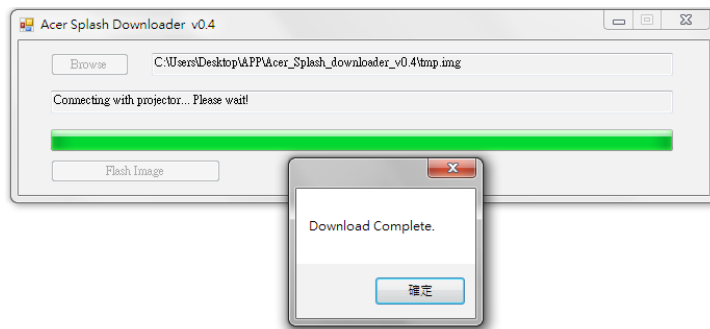

7. Reboot projector

Plug-out the power cord of projector and plug-in it. Please ensure that the logo has been upgraded correctly.

8. Operating system compatibility

| | |
|---------------------------|-------------|
| Operating system platform | compatible |
| Windows XP | Not support |
| Windows 7 (64 bit) | Support |
| Windows 10 (64 bit) | Support |
| Mac OS | Not support |

Background Color

Use this function to display a blue, red, green, gray color, black, or logo screen when no signal is available.

Setup reset OSD menu

Reset to Default

Return the factory default settings for all settings except network setting.

USING THE PROJECTOR

Network menu

Note: Functions vary depending on model definition.

Network LAN menu

Network Status

Display the network connection status (read-only).

MAC Address

Display the MAC address (read-only).

DHCP

Use this option to enable or disable the DHCP function.

- **Off:** To assign IP, subnet mask, gateway, and DNS configuration manually.
- **On:** Projector will obtain an IP address automatically from your network.

Note: Exiting OSD will automatically apply the entered values.

IP Address

Display the IP address.

Subnet Mask

Display subnet mask number.

Gateway

Display the default gateway of the network connected to the projector.

DNS

Display the DNS number.

How to use web browser to control your projector

1. Turn "On" the DHCP option on projector to allow a DHCP server to automatically assign an IP address.
2. Open the web browser in your PC and type in the projector's IP address ("Network > LAN > IP Address").
3. Enter the user name and password, and click "Login".
The projector's configuration web interface opens.

Note:

- The default user name and password is "admin".
- The steps in this section is based on Windows 7 operating system.

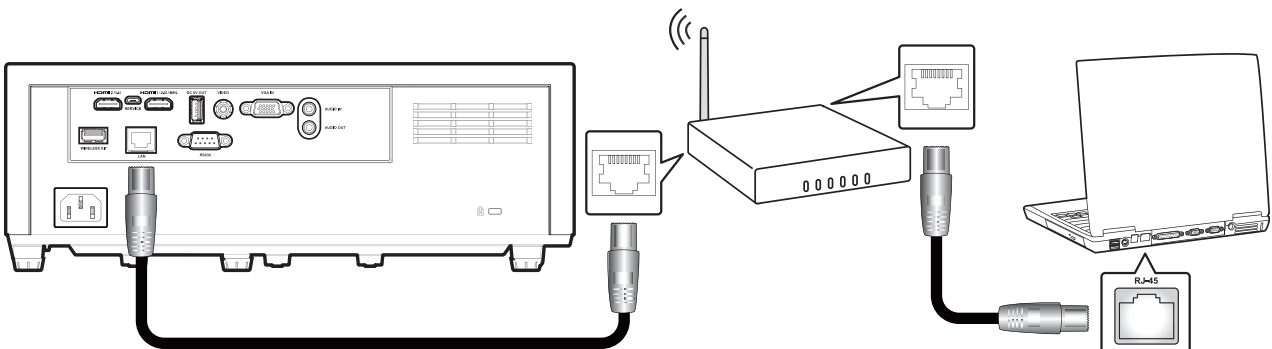

USING THE PROJECTOR

Making a direct connection from your computer to the projector*

1. Turn “Off” the DHCP option on the projector.
2. Configure the IP address, Subnet Mask, Gateway, and DNS on projector (“Network > LAN”).
3. Open **Network and Sharing Center** page on your PC, and assign the identical network parameters to your PC as set on projector. Click “OK” to save the parameters.

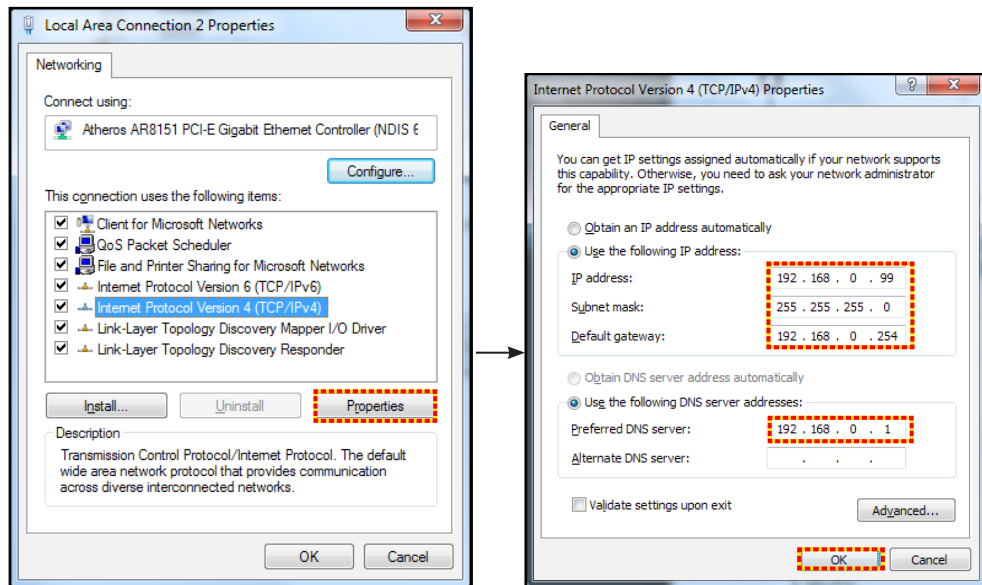

4. Open the web browser on your PC and type in to the URL field the IP address, assigned in step 3. Then press “Enter” key.

Reset

Reset all values for LAN parameters.

Network control menu

Crestron

Use this function to select the network function (port: 41794).

For more information, please visit <http://www.crestron.com> and www.crestron.com/getroomview.

Extron

Use this function to select the network function (port: 2023).

PJ Link

Use this function to select the network function (port: 4352).

AMX Device Discovery

Use this function to select the network function (port: 9131).

Telnet

Use this function to select the network function (port: 23).

HTTP

Use this function to select the network function (port: 80).

USING THE PROJECTOR

Setup network control settings menu

LAN_RJ45 function

For simplicity and ease of operation, the projector provides diverse networking and remote management features. The LAN / RJ45 function of the projector through a network, such as remotely manage: Power On / Off, brightness, and contrast settings. Also, you can view the projector status information, such as: Video- Source, Sound-Mute, etc.

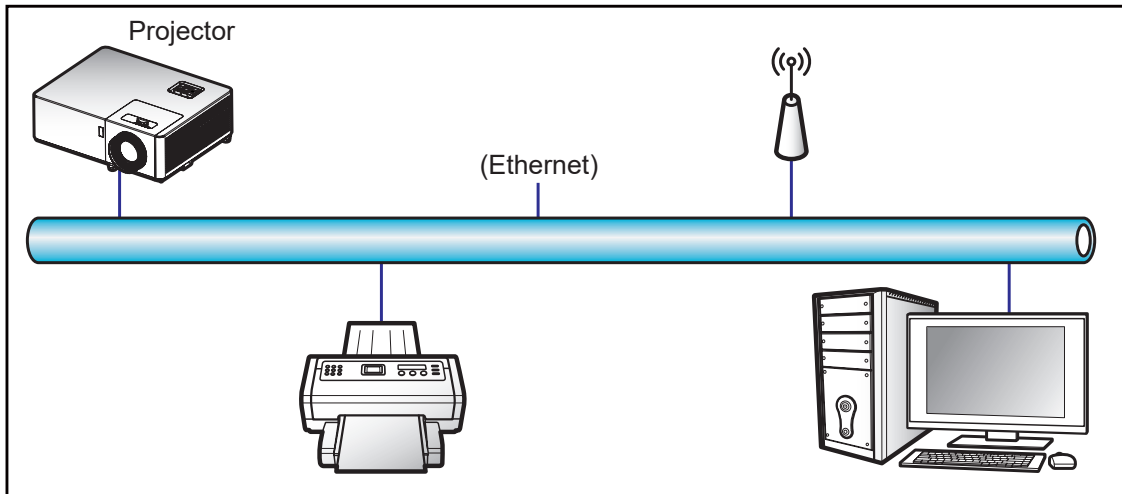

Wired LAN terminal functionalities

This projector can be controlled by using a PC (laptop) or other external device via LAN / RJ45 port and compatible with Crestron / Extron / AMX (Device -Discovery) / PJLink.

- Crestron is a registered trademark of Crestron Electronics, Inc. of the United States.
- Extron is a registered trademark of Extron Electronics, Inc. of the United States.
- AMX is a registered trademark of AMX LLC of the United States.
- PJLink applied for trademark and logo registration in Japan, the United States of America, and other countries by JBMIA.

The projector is supported by the specified commands of the Crestron Electronics controller and related software, for example RoomView®.

<http://www.crestron.com/>

This projector is compliant to support Extron device(s) for reference.

<http://www.extron.com/>

This projector is supported by AMX (Device Discovery).

<http://www.amx.com/>

This projector supports most commands of PJLink Class1/2 (Version 1.00/2.00)

<http://pjlink.jbmia.or.jp/english/>

For more detailed information about the various types of external devices which can be connected to the LAN / RJ45 port and remote control the projector, as well as the supported commands for these external devices, please contact the Support-Service directly.

USING THE PROJECTOR

LAN RJ45

1. Connect an RJ45 cable to RJ45 ports on the projector and the PC (laptop).

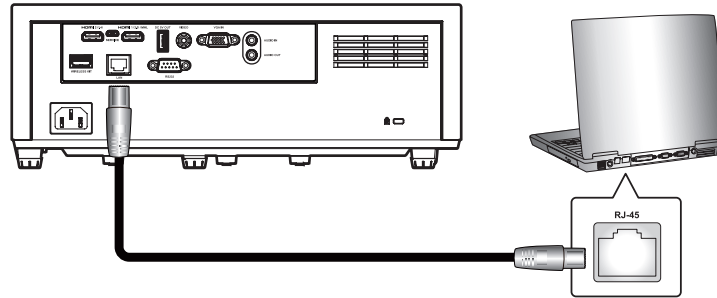

2. On the PC (Laptop), select **Start > Control Panel > Network Connections**.

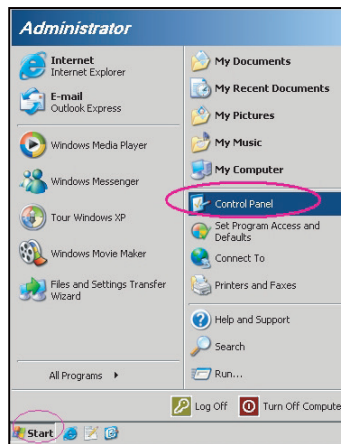

3. Right-click on the **Local Area Connection**, and select **Property**.

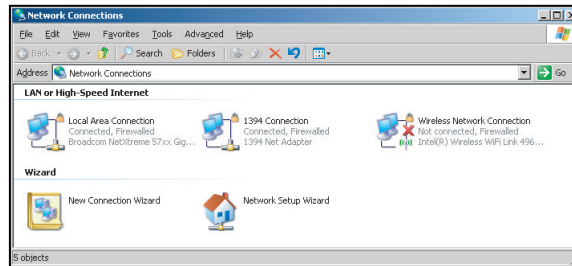

4. In the **Properties** window, select the **General** tab, and select **Internet Protocol (TCP / IP)**.

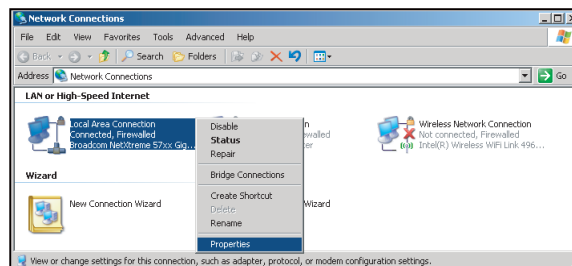

USING THE PROJECTOR

5. Click "Properties".

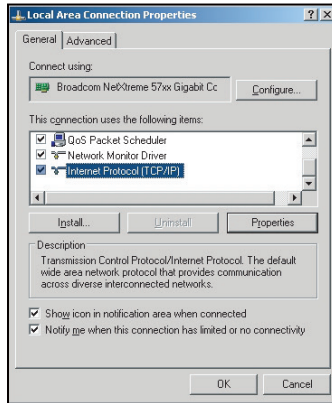

6. Type in the IP address and Subnet mask, then press "OK".

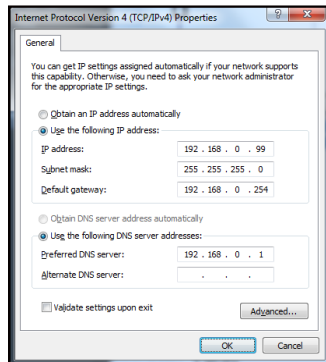

7. Press the "Menu" button on the projector.
8. Open on projector **Network > LAN**.
9. Enter the following connection parameters:
 - DHCP: Off
 - IP Address: 192.168.0.100
 - Subnet Mask: 255.255.255.0
 - Gateway: 192.168.0.254
 - DNS: 192.168.0.51
10. Press "Enter" to confirm settings.
11. Open a web browser, for example Microsoft Internet Explorer with Adobe Flash Player 9.0 or higher installed.
12. In the Address bar, input the projector's IP address: 192.168.0.100.

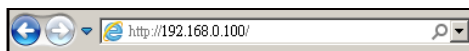

13. Press "Enter". (The default user name and password is "admin".)

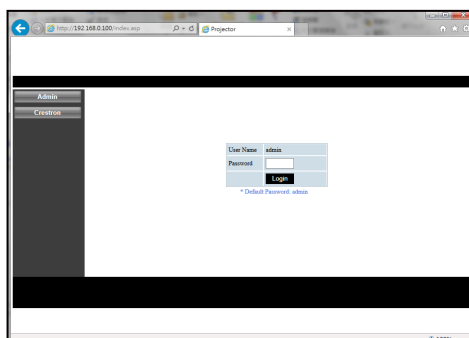

USING THE PROJECTOR

The projector is setup for remote management. The LAN / RJ45 function displays as follows:

Information page

Main page

Tool page

Contact IT helpdesk

USING THE PROJECTOR

RS232 by Telnet Function

There is alternative RS232 command control way, in projector so called “RS232 by TELNET” for LAN / RJ45 interface.

Quick Start-Guide for “RS232 by Telnet”

- Check and get the IP address on OSD of the projector.
- Make sure that the PC / laptop can access the web-page of the projector.
- Make sure that “Windows Firewall” setting is set disabled in case of “TELNET” function filtering out by PC / laptop.

Windows 7

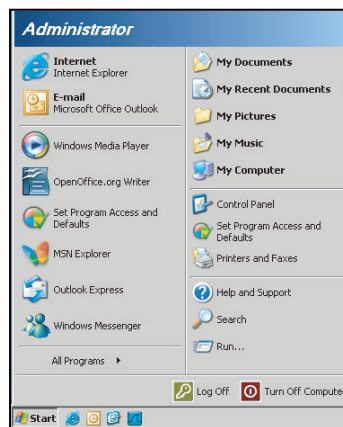

Windows 10

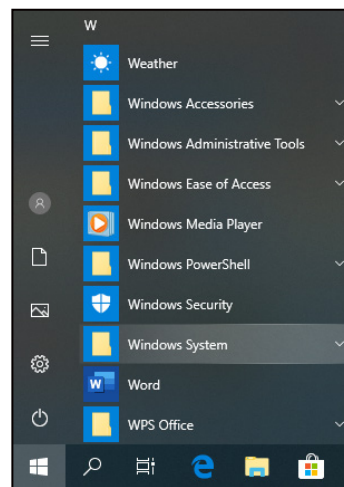

1. Select **Start > All Programs > Accessories > Command Prompt**.

Windows 7

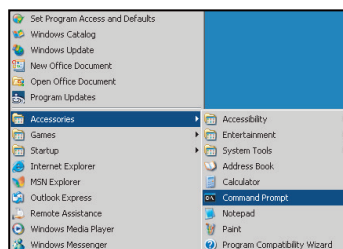

Windows 10

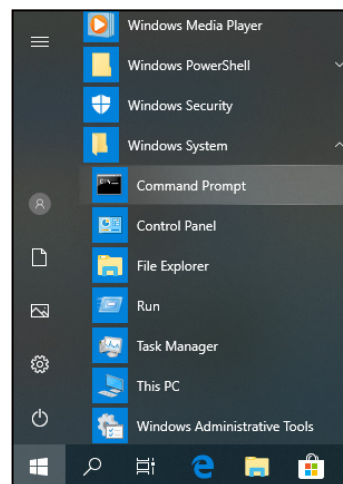

2. Input the command format as follows:
 - telnet ttt.xxx.yyy.zzz 23 (“Enter” key pressed)
 - (ttt.xxx.yyy.zzz: IP-Address of the projector)
3. If Telnet-Connection ready, and user can have RS232 command input, then “Enter” key pressed, the RS232 command will be workable.

How to have TELNET enabled in Windows 7 / 8 / 10

By default installation for Windows 7 / 8 / 10, “TELNET” function is not included. But end-user can have it by way of “Turn Windows features On or Off” to be enabled.

USING THE PROJECTOR

Open "Control Panel" in Windows 7 / 8 / 10.

Windows 7

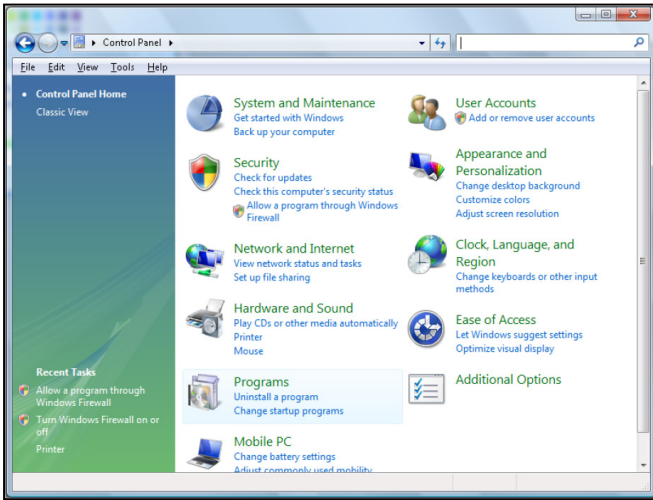

Windows 10

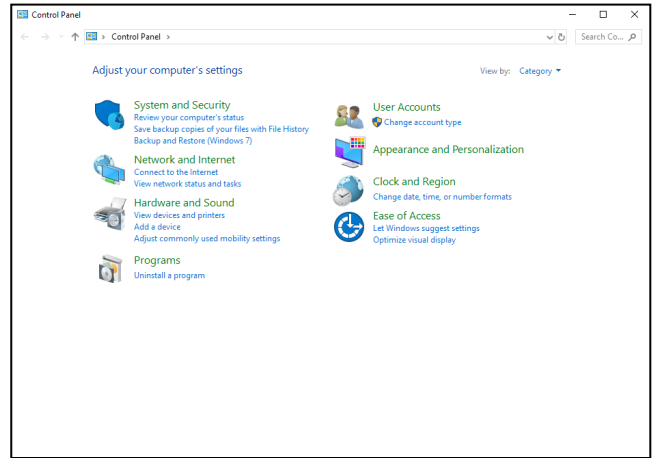

Open "Programs"

Windows 7

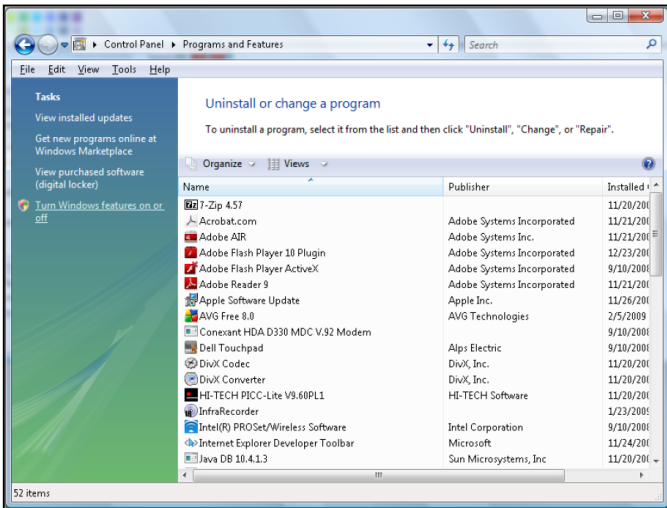

Windows 10

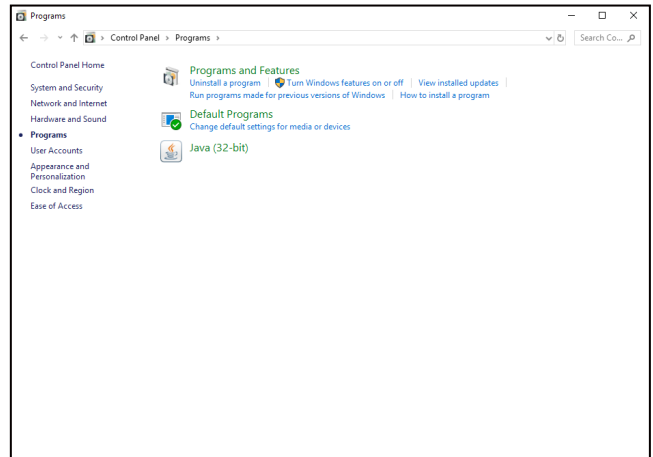

Select "Turn Windows features on or off" to open.

Windows 7

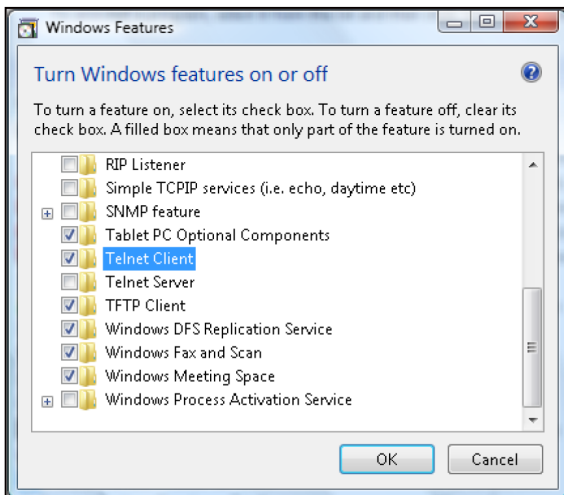

Windows 10

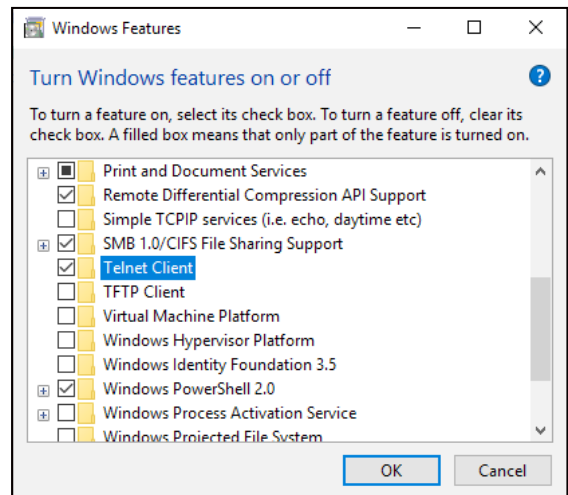

Have "Telnet Client" option checked, then press "OK" button.

USING THE PROJECTOR

Specification for “RS232 by TELNET”:

1. Telnet: TCP.
2. Telnet port: 23 (for more detail, kindly please get contact with the service agent or team).
3. Telnet utility: Windows “TELNET.exe” (console mode).
4. Disconnection for RS232-by-Telnet control normally: Close
5. Windows Telnet utility directly after TELNET connection ready.
 - Limitation 1 for Telnet-Control: there is less than 50 bytes for successive network payload for Telnet-Control application.
 - Limitation 2 for Telnet-Control: there is less than 26 bytes for one complete RS232 command for Telnet-Control.
 - Limitation 3 for Telnet-Control: Minimum delay for next RS232 command must be more than 200 (ms).

Info menu

Note: *Functions vary depending on model definition.*

Info menu

View the projector information as listed below:

- Serial Number
- Source
- Resolution
- Refresh Rate
- Display Mode
- Power Mode (Standby)
- Light Source Hours
- Network Status
- IP Address
- Brightness Mode
- FW Version

ADDITIONAL INFORMATION

Compatible resolutions

Digital compatibility

| Digital (HDMI 1.4) | | | | |
|-------------------------|----------------------|--------------------|--------------------------|----------------------|
| B0 / Established Timing | B0 / Standard Timing | B0 / Detail Timing | B1 / Video Mode | B1 / Detail Timing |
| 720 x 400 @ 70Hz | 1280 x 720 @ 60Hz | WXGA: | 640 x 480P @ 60Hz 4:3 | 1920 x 1080p @ 60Hz |
| 640 x 480 @ 60Hz | 1280 x 800 @ 60Hz | 1280 x 800@60Hz | 720 x 480i @ 60Hz 16:9 | 1366x768@60Hz |
| 640 x 480 @ 67Hz | 1280 x 1024 @ 60Hz | 1080p: | 720 x 480p @ 60Hz 4:3 | 1920 x 1080p @120Hz |
| 640 x 480 @ 72Hz | 1600x1200@60Hz | 1920 x 1080@60Hz | 720 x 480p @ 60Hz 16:9 | 1920 x 1200@60Hz- RB |
| 640 x 480 @ 75Hz | | XGA: | 720 x 576i @ 50Hz 16:9 | |
| 800 x 600 @ 56Hz | 640 x 480@120Hz | 1024 x 768@60Hz | 720 x 576p @ 50Hz 4:3 | |
| 800 x 600 @ 60Hz | 800 x 600@120Hz | | 720 x 576p @ 50Hz 16:9 | |
| 800 x 600 @ 72Hz | 1024 x 768@120Hz | | 1280 x 720p @ 60Hz 16:9 | |
| 800 x 600 @ 75Hz | 1280 x 800@120Hz | | 1280 x 720p @ 50Hz 16:9 | |
| 832 x 624 @ 75Hz | | | 1920 x 1080i @ 60Hz 16:9 | |
| 1024 x 768 @ 60Hz | | | 1920 x 1080i @ 50Hz 16:9 | |
| 1024 x 768 @ 70Hz | | | 1920 x 1080p @ 60Hz 16:9 | |
| 1024 x 768 @ 75Hz | | | 1920 x 1080p @ 50Hz 16:9 | |
| 1280 x 1024 @ 75Hz | | | 1920 x 1080p @ 24Hz 16:9 | |
| 1152 x 870 @ 75Hz | | | 3840 x 2160 @ 24Hz | |
| | | | 3840 x 2160 @ 25Hz | |
| | | | 3840 x 2160 @ 30Hz | |
| | | | 4096 x 2160 @ 24Hz | |

| Digital (HDMI 2.0) | | | | |
|-------------------------|----------------------|--------------------|--------------------------|----------------------|
| B0 / Established Timing | B0 / Standard Timing | B0 / Detail Timing | B1 / Video Mode | B1 / Detail Timing |
| 720 x 400 @ 70Hz | 1280 x 720 @ 60Hz | WXGA: | 640 x 480P @ 60Hz 4:3 | 1920 x 1200@60Hz- RB |
| 640 x 480 @ 60Hz | 1280 x 800 @ 60Hz | 1280x800@60Hz | 720 x 480p @ 60Hz 16:9 | 1366x768@60Hz |
| 640 x 480 @ 67Hz | 1280x1024 @ 60Hz | 1080p: | 720 x 576p @ 50Hz 4:3 | 1920x1080@120Hz |
| 640 x 480 @ 72Hz | 1600x1200@60Hz | 1920x1080@60Hz | 720 x 576p @ 50Hz 16:9 | |
| 640 x 480 @ 75Hz | | XGA: | 1280 x 720p @ 60Hz 16:9 | |
| 800 x 600 @ 56Hz | 640x480@120Hz | 1024 x 768@60Hz | 1280 x 720p @ 50Hz 16:9 | |
| 800 x 600 @ 60Hz | 800x600@120Hz | | 1920 x 1080i @ 60Hz 16:9 | |
| 800 x 600 @ 72Hz | 1024x768@120Hz | | 1920 x 1080i @ 50Hz 16:9 | |
| 800 x 600 @ 75Hz | 1280x800@120Hz | | 1920 x 1080p @ 60Hz 16:9 | |
| 832 x 624 @ 75Hz | | | 1920 x 1080p @ 50Hz 16:9 | |
| 1024 x 768 @ 60Hz | | | 1920 x 1080p @ 24Hz 16:9 | |
| 1024 x 768 @ 70Hz | | | 3840 x 2160 @ 24Hz 16:9 | |
| 1024 x 768 @ 75Hz | | | 3840 x 2160 @ 25Hz 16:9 | |
| 1280 x 1024 @ 75Hz | | | 3840 x 2160 @ 30Hz 16:9 | |
| 1152 x 870@ 75Hz | | | 4096 x 2160 @ 24Hz | |
| | | | 3840 x 2160 @ 50Hz | |
| | | | 3840 x 2160 @ 60Hz | |
| | | | 4096 x 2160 @ 50Hz | |
| | | | 4096 x 2160 @ 60Hz | |
| | | | 4096 x 2160 @ 25Hz | |
| | | | 4096 x 2160 @ 30Hz | |

ADDITIONAL INFORMATION

Note: Functions vary depending on model definition.

Analog compatibility

| B0 / Established Timing | B0 / Standard Timing | B0 / Detail Timing | B1 / Video Mode | B1 / Detail Timing |
|-------------------------|----------------------|--------------------|-----------------|----------------------|
| 720 x 400 @ 70Hz | 1280 x 720 @ 60Hz | WXGA: | | 1280x800@120Hz(RB) |
| 640 x 480 @ 60Hz | 1280 x 800 @ 60Hz | 1280x800@60Hz | | 1900x1200 @ 60Hz(RB) |
| 640 x 480 @ 67Hz | 1280 x 1024 @ 60Hz | 1080p: | | 1366x768@60Hz |
| 640 x 480 @ 72Hz | 1600 x 1200 @ 60Hz | 1920x1080@60Hz | | |
| 640 x 480 @ 75Hz | 1280 x 960 @ 60Hz | XGA: | | |
| 800 x 600 @ 56Hz | 640 x 480 @ 120Hz | 1024 x 768@60Hz | | |
| 800 x 600 @ 60Hz | 800 x 600 @ 120Hz | | | |
| 800 x 600 @ 72Hz | 1024 x 768 @ 120Hz | | | |
| 800 x 600 @ 75Hz | | | | |
| 832 x 624 @ 75Hz | | | | |
| 1024 x 768 @ 60Hz | | | | |
| 1024 x 768 @ 70Hz | | | | |
| 1024 x 768 @ 75Hz | | | | |
| 1280 x 1024 @ 75Hz | | | | |
| 1152 x 870 @ 75Hz | | | | |

Note: Functions vary depending on model definition.

MHL compatibility

| Modes | Resolution | V. Frequency [Hz] | H. Frequency [Hz] |
|--|------------------------------|--------------------------|-------------------|
| MHL Digital | | | |
| VGA | 640x480 | 59.94/60 | 31.5 |
| 480i | 1440x480 | 59.94/60 | 15.7 |
| 576i | 1440x576 | 50.0 | 15.7 |
| 480p | 720x480 | 59.94/60 | 15.6 |
| 576p | 720x576 | 50.0 | 15.6 |
| 720p | 1280x720 | 59.94/60 | 31.5 |
| 720p | 1280x720 | 50.0 | 31.5 |
| 1080i | 1920x1080 | 60.0 | 31.3 |
| 1080i | 1920x1080 | 50.0 | 31.3 |
| 1080p | 1920x1080 | 23.97/24 | 45.0 |
| 1080p | 1920x1080 | 25.0 | 37.5 |
| 1080p | 1920x1080 | 29.97/30 | 33.8 |
| 1080p | 1920x1080 | 50.0 | 28.1 |
| 1080p | 1920x1080 | 60.0 | 27.0 |
| Graphic source monitor range limits | Horizontal scan rate: | 15k-68kHz | |
| | Vertical scan rate: | 24-60Hz | |
| | Max. pixel rate: | Digital: 148.5MHz | |

ADDITIONAL INFORMATION

True 3D video compatibility

| Input resolutions | HDMI 3D Input (with 3D InfoFrame information) | Input timing | | |
|--------------------------|--|---------------------|-------------------------------|----------------|
| | | 1280 x 720P @ 50Hz | Top-and-Bottom | |
| | | 1280 x 720P @ 60Hz | Top-and-Bottom | |
| | | 1280 x 720P @ 50Hz | Frame packing | |
| | | 1280 x 720P @ 60Hz | Frame packing | |
| | | 1920 x 1080i @ 50Hz | Side-by-Side(Half) | |
| | | 1920 x 1080i @ 60Hz | Side-by-Side(Half) | |
| | | 1920 x 1080P @ 24Hz | Top-and-Bottom | |
| | | 1920 x 1080P @ 24Hz | Frame packing | |
| | HDMI 3D Input (without 3D InfoFrame information) | 1920 x 1080i @ 50Hz | Side-by-Side(Half) | SBS mode is on |
| | | 1920 x 1080i @ 60Hz | | |
| | | 1280 x 720P @ 50Hz | | |
| | | 1280 x 720P @60Hz | Top-and-Bottom | TAB mode is on |
| | | 1920 x 1080i @ 50Hz | | |
| | | 1920 x 1080i @ 60Hz | | |
| | | 1280 x 720P @ 50Hz | | |
| | | 1280 x 720P @60Hz | | |
| 480i | | HQFS | 3D format is Frame sequential | |

Note:

- If 3D input is 1080p@24Hz, the DMD should replay with integral multiple with 3D mode.
- 1080i@25Hz and 720p@50Hz will run in 100Hz; 1080p@24Hz will run in 144Hz except WUXGA model is 96Hz; other 3D timing will run in 120Hz.
- Functions vary depending on model definition.

ADDITIONAL INFORMATION

Image size and projection distance

WXGA Series for 1.3x zoom

To obtain an image size of 60" set the projector at a distance 1.5 m and 2.0 m from the screen.

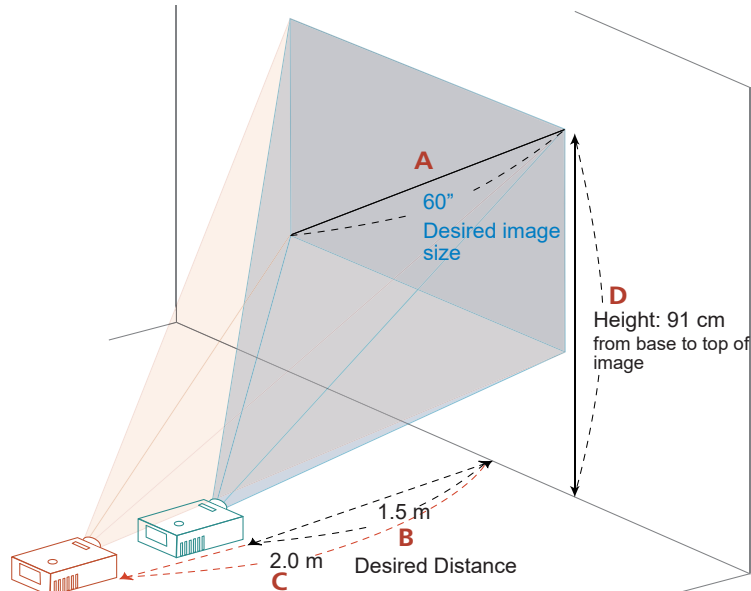

| Desired image size | | Distance (m) | | Top (cm) |
|--------------------|-----------------|--------------|----------|---------------------------|
| Diagonal (inch) | W (cm) x H (cm) | Max zoom | Min zoom | From base to top of image |
| <A> | | | <C> | <D> |
| 30.07 | 65 x 40 | | 1.0 | 45 |
| 40 | 86 x 54 | 1.0 | 1.3 | 61 |
| 50 | 108 x 67 | 1.3 | 1.7 | 76 |
| 60 | 129 x 81 | 1.5 | 2.0 | 91 |
| 70 | 151 x 94 | 1.8 | 2.3 | 106 |
| 80 | 172 x 108 | 2.0 | 2.7 | 121 |
| 90 | 194 x 121 | 2.3 | 3.0 | 136 |
| 100 | 215 x 135 | 2.6 | 3.3 | 151 |
| 150 | 323 x 202 | 3.8 | 5.0 | 227 |
| 180 | 388 x 242 | 4.6 | 6.0 | 272 |
| 200 | 431 x 269 | 5.1 | 6.7 | 303 |
| 250 | 538 x 337 | 6.4 | | 378 |
| 301.2 | 649 x 405 | 7.7 | | 456 |

Zoom Ratio: 1.3x

ADDITIONAL INFORMATION

XGA Series for 1.3x zoom

To obtain an image size of 60" set the projector at a distance 1.8 m and 2.4 m from the screen.

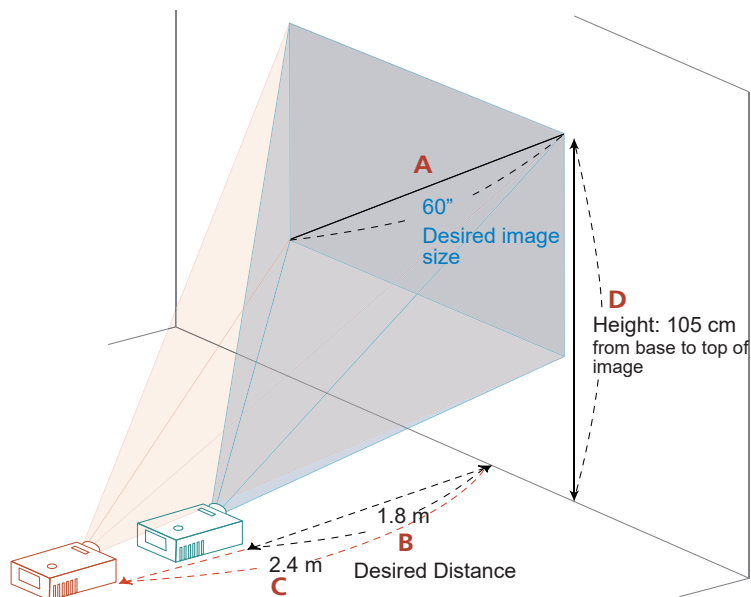

| Desired image size | | Distance (m) | | Top (cm) |
|--------------------|-----------------|--------------|----------|---------------------------|
| Diagonal (inch) | W (cm) x H (cm) | Max zoom | Min zoom | From base to top of image |
| <A> | | | <C> | <D> |
| 25.5 | 52 x 39 | | 1.0 | 45 |
| 30 | 61 x 46 | | 1.2 | 53 |
| 40 | 81 x 61 | 1.2 | 1.6 | 70 |
| 50 | 102 x 76 | 1.5 | 2.0 | 88 |
| 60 | 122 x 91 | 1.8 | 2.4 | 105 |
| 70 | 142 x 107 | 2.1 | 2.7 | 123 |
| 80 | 163 x 122 | 2.4 | 3.1 | 140 |
| 90 | 183 x 137 | 2.7 | 3.5 | 158 |
| 100 | 203 x 152 | 3.0 | 3.9 | 175 |
| 150 | 305 x 229 | 4.5 | 5.9 | 263 |
| 180 | 366 x 274 | 5.4 | 7.1 | 315 |
| 200 | 406 x 305 | 6.0 | 7.8 | 351 |
| 250 | 508 x 381 | 7.6 | | 438 |
| 301.2 | 612 x 459 | 9.1 | | 528 |

Zoom Ratio: 1.3x

ADDITIONAL INFORMATION

WXGA Series for fixed zoom

To obtain an image size of 60" set the projector at a distance 0.67 m from the screen.

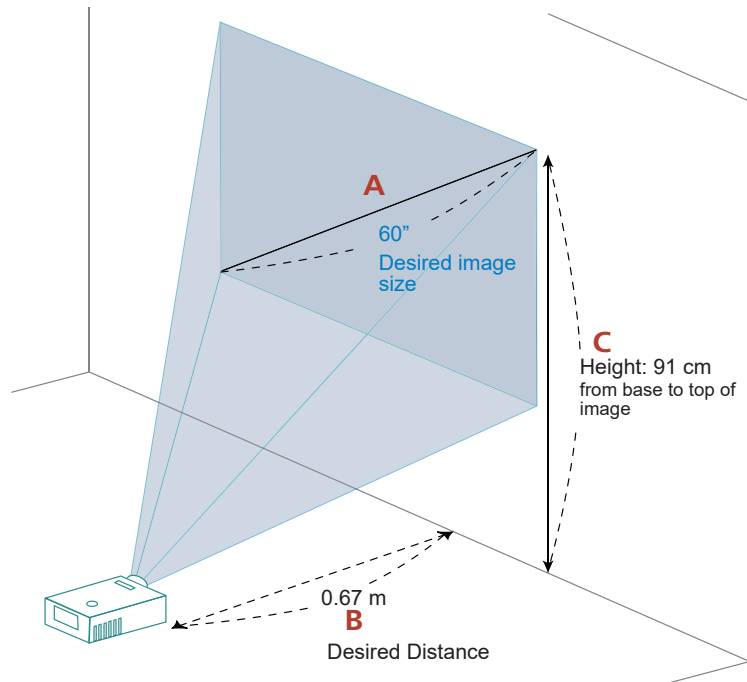

| Desired image size | | Distance (m) | Top (cm) |
|------------------------|-----------------|-----------------|----------------------------------|
| Diagonal (inch) <A> | W (cm) x H (cm) | Max zoom | From base to top of image <C> |
| 35.64 | 77 x 48 | 0.40 | 54 |
| 40 | 86 x 54 | 0.45 | 61 |
| 50 | 108 x 67 | 0.56 | 76 |
| 60 | 129 x 81 | 0.67 | 91 |
| 70 | 151 x 94 | 0.79 | 106 |
| 80 | 172 x 108 | 0.90 | 121 |
| 87.2 | 188 x 117 | 0.979 | 132 |
| 90 | 194 x 121 | 1.01 | 136 |
| 100 | 215 x 135 | 1.12 | 151 |
| 120 | 258 x 162 | 1.35 | 182 |
| 150 | 323 x 202 | 1.68 | 227 |
| 180 | 388 x 242 | 2.02 | 272 |
| 250 | 538 x 337 | 2.81 | 378 |
| 300 | 646 x 404 | 3.37 | 454 |

Zoom Ratio: 1.0x

ADDITIONAL INFORMATION

XGA Series for fixed zoom

To obtain an image size of 60" set the projector at a distance 0.75 m from the screen.

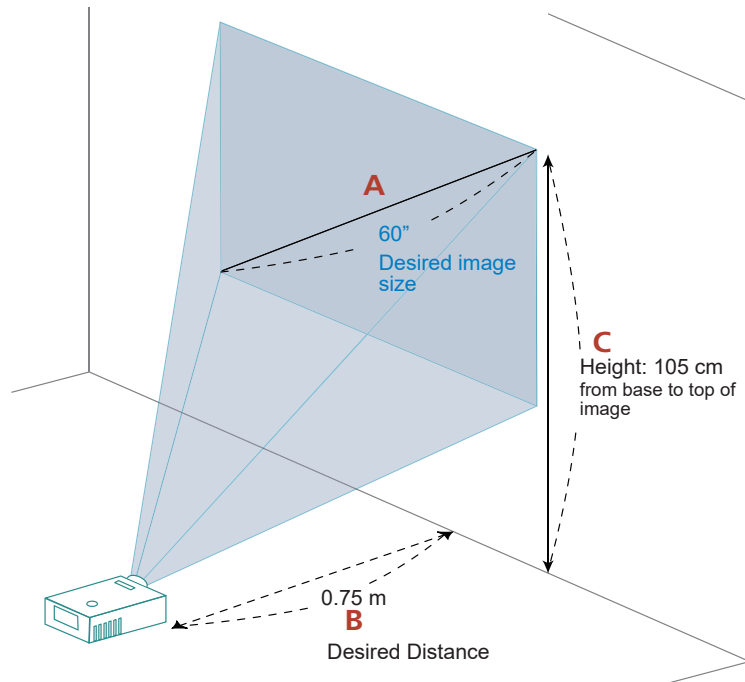

| Desired image size | | Distance (m) | Top (cm) |
|------------------------|-----------------|-----------------|----------------------------------|
| Diagonal (inch) <A> | W (cm) x H (cm) | Max zoom | From base to top of image <C> |
| 31.9 | 65 x 49 | 0.40 | 56 |
| 40 | 81 x 61 | 0.50 | 70 |
| 50 | 102 x 76 | 0.63 | 88 |
| 60 | 122 x 91 | 0.75 | 105 |
| 70 | 142 x 107 | 0.88 | 123 |
| 80 | 163 x 122 | 1.00 | 140 |
| 90 | 183 x 137 | 1.13 | 158 |
| 100 | 203 x 152 | 1.25 | 175 |
| 120 | 244 x 183 | 1.50 | 210 |
| 150 | 305 x 229 | 1.88 | 263 |
| 180 | 366 x 274 | 2.26 | 315 |
| 250 | 508 x 381 | 3.13 | 438 |
| 300 | 610 x 457 | 3.76 | 526 |

Zoom Ratio: 1.0x

ADDITIONAL INFORMATION

1080p series

To obtain an image size of 60" set the projector at a distance 1.6 m and 2.1 m from the screen.

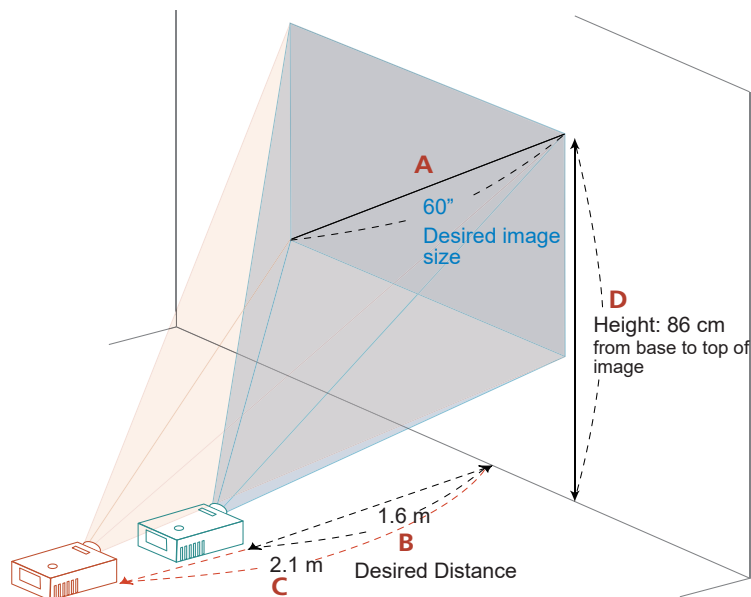

| Desired image size | | Distance (m) | | Top (cm) |
|------------------------|-----------------|-----------------|-----------------|----------------------------------|
| Diagonal (inch) <A> | W (cm) x H (cm) | Max zoom | Min zoom <C> | From base to top of image <D> |
| 28 | 62 x 35 | | 1.0 | 40 |
| 38 | 84 x 47 | 1.0 | 1.3 | 54 |
| 40 | 89 x 50 | 1.1 | 1.4 | 57 |
| 50 | 111 x 62 | 1.3 | 1.8 | 72 |
| 60 | 133 x 75 | 1.6 | 2.1 | 86 |
| 70 | 155 x 87 | 1.9 | 2.5 | 100 |
| 80 | 177 x 100 | 2.1 | 2.8 | 115 |
| 90 | 199 x 112 | 2.4 | 3.2 | 129 |
| 100 | 221 x 125 | 2.7 | 3.5 | 143 |
| 120 | 266 x 149 | 3.2 | 4.2 | 172 |
| 150 | 332 x 187 | 4.0 | 5.3 | 215 |
| 180 | 398 x 224 | 4.8 | 6.3 | 258 |
| 200 | 443 x 249 | 5.4 | 7.0 | 286 |
| 250 | 553 x 311 | 6.7 | | 358 |
| 300.3 | 665 x 374 | 8.0 | | 430 |

Zoom Ratio: 1.31x

ADDITIONAL INFORMATION

The projector is equipped with lens shift for adjusting the position of projected image up and down without requiring you to physically move the projector.

Note: The figures shown in this section are for reference only not approximate value. The figures between units can be different due to assembly tolerance.

The vertical height can be adjusted between 5% and 15% of the image height. (The typical vertical image offset is fixed at 15% of the image height above the center of the projector lens.)

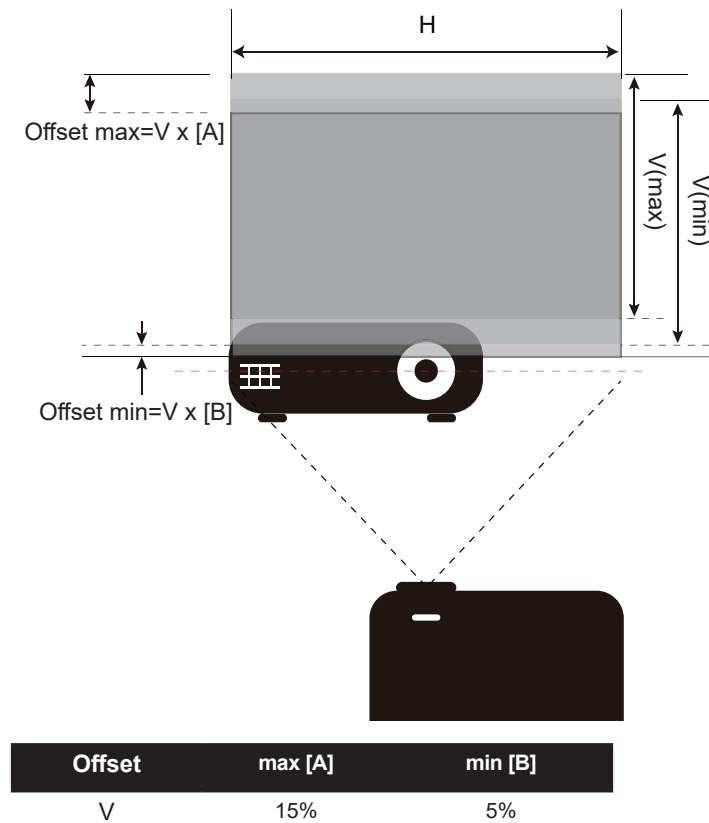

ADDITIONAL INFORMATION

Projector dimensions and ceiling mount installation

1. To prevent damage to your projector, please use the Acer ceiling mount.
2. If you wish to use a third party ceiling mount kit, please ensure the screws used to attach a mount to the projector meet the following specifications:
 - Screw type: M4*9
 - Minimum screw length: 9mm

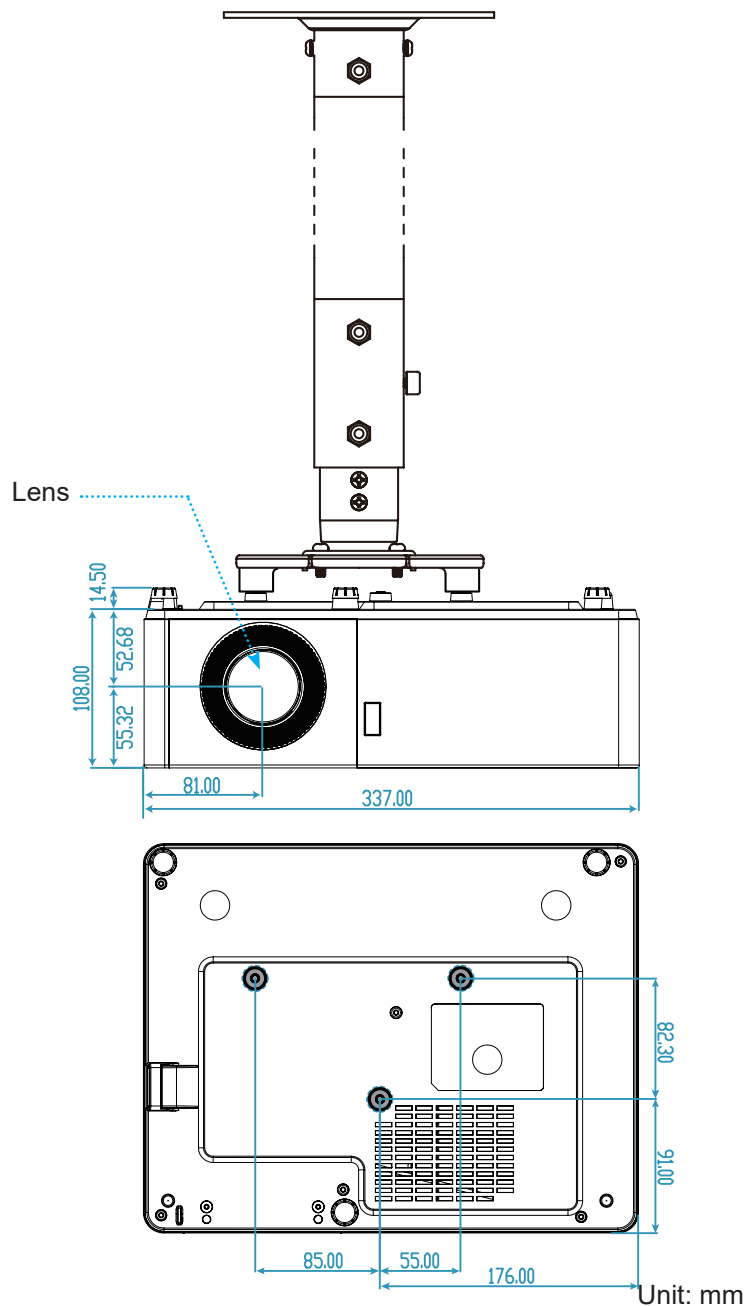

Note: Please note that damage resulting from incorrect installation will void the warranty.



Warning:







- If you buy a ceiling mount from another company, please be sure to use the correct screw size. Screw size will vary depending on the thickness of the mounting plate.
- Be sure to keep at least 10 cm gap between the ceiling and the bottom of the projector.
- Avoid installing the projector near a heat source.

ADDITIONAL INFORMATION

Troubleshooting

If you experience a problem with your projector, please refer to the following information. If a problem persists, please contact your local reseller or service center.

Image problems

-  *No image appears on-screen*
- Ensure all the cables and power connections are correctly and securely connected as described in the "Installation" section.
 - Ensure the pins of connectors are not crooked or broken.
 - Ensure that the "Mute" feature is not turned on.
-  *Image is out of focus*
- Turn the focus ring clockwise or counterclockwise until the image is sharp and legible. (Please see page 20).
 - Make sure the projection screen is between the required distance from the projector. (Please refer to pages 57-57).
-  *The image is stretched when displaying 16:9 DVD title*
- When you play anamorphic DVD or 16:9 DVD, the projector will show the best image in 16: 9 format on projector side.
 - If you play the LBX format DVD title, please change the format as LBX in projector OSD.
 - If you play 4:3 format DVD title, please change the format as 4:3 in projector OSD.
 - Please setup the display format as 16:9 (wide) aspect ratio type on your DVD player.
-  *Image is too small or too large*
- Turn the zoom lever clockwise or counterclockwise to increase or decrease the projected image size. (Please see page 20).
 - Move the projector closer to or further from the screen.
 - Press "Menu" on the projector panel, go to "Display → Aspect Ratio". Try the different settings.
-  *Image has slanted sides:*
- If possible, reposition the projector so that it is centered on the screen and below the bottom of the screen.
-  *Image is reversed*
- Select "Setup → Projection" from the OSD and adjust the projection direction.

ADDITIONAL INFORMATION

Other problems



The projector stops responding to all controls

- If possible, turn off the projector, then unplug the power cord and wait at least 20 seconds before reconnecting power.

Remote control problems



If the remote control does not work

- Check the operating angle of the remote control is pointed within $\pm 20^\circ$ to the IR receiver on the projector.
- Make sure there are not any obstructions between the remote control and the projector. Move to within 5 m (16.4 ft) of the projector.
- Make sure batteries are inserted correctly.
- Replace batteries if they are exhausted.

Warning indicators

When the warning indicators (see below) light up or flash, the projector will automatically shutdown:

- “Lamp” LED indicator is lit red and if “Power” indicator flashes red.
- “Temp” LED indicator is lit red and if “Power” indicator flashes red. This indicates the projector has overheated. Under normal conditions, the project can be switched back on.
- “Temp” LED indicator flashes red and if “Power” indicator flashes red.

Unplug the power cord from the projector, wait for 30 seconds and try again. If the warning indicator light up or flash, please contact your nearest service center for assistance.

ADDITIONAL INFORMATION

LED lightning messages

| Message | Power LED | | Temp LED | Lamp LED |
|-------------------------------------|--------------|--|--------------|--------------|
| | (Red) | (Blue) | (Red) | (Red) |
| Standby state (Input power cord) | Steady light | | | |
| Power on (Warming) | | Flashing (0.5 sec off / 0.5 sec on) | | |
| Power on and Lamp lighting | | Steady light | | |
| Power off (Cooling) | | Flashing (0.5 sec off / 0.5 sec on). Back to red steady light when cooling fan turns off. | | |
| Error (Lamp failure) | Flashing | | | Steady light |
| Error (Fan failure) | Flashing | | Flashing | |
| Error (Over temp.) | Flashing | | Steady light | |

- Power off:

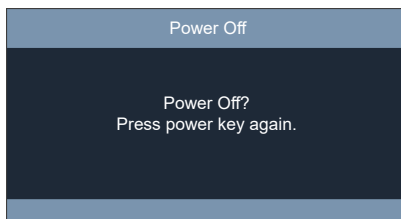

- Temperature warning:

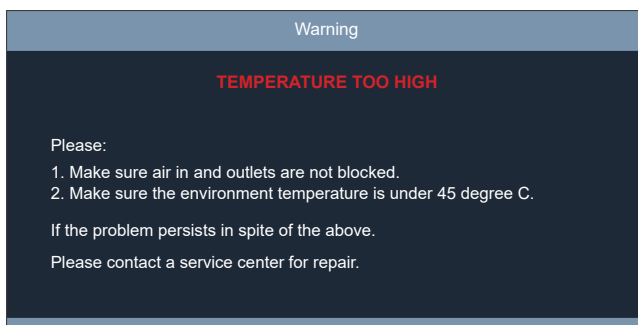

ADDITIONAL INFORMATION

Specifications

| Optical | Description |
|-----------------------|--|
| Maximum resolution | 1920x1200@60Hz(RB) |
| Native resolution | <ul style="list-style-type: none"> XGA 1024(H) x 768(V) WXGA 1280(H) x 800(V) 1080p 1920(H) x 1080(V) |
| Lens | Manual zoom and manual focus |
| Image size (diagonal) | <ul style="list-style-type: none"> XGA: 25.5" ~ 301.2" (65cm ~ 765cm) WXGA: 30" ~ 300" (76cm ~ 762cm) 1080p: 28" ~ 300" (72cm ~ 762cm) XGA (Fixed zoom): 32" ~ 300" (81cm ~ 762cm) WXGA (Fixed zoom): 36" ~ 300" (91cm ~ 762cm) |
| Projection distance | <ul style="list-style-type: none"> XGA: 1m ~ 9.1m (3.3"~29.7") WXGA: 1m ~ 7.7m (3.3"~25.2") 1080p: 1m ~ 8m (3.3"~26.4") XGA (Fixed zoom): 0.4m ~ 3.8m (1.3"~12.3") WXGA (Fixed zoom): 0.4m ~ 3.4m (1.3"~11") |

| Electrical | Description |
|--------------------|--|
| Inputs | <ul style="list-style-type: none"> HDMI 1.4a HDMI 2.0b / MHL 2.2 VGA in Composite (RCA connector (Y)) Audio In 3.5mm Micro-USB for FW update USB Type A for WiFi (For 1080p only) |
| Outputs | <ul style="list-style-type: none"> Audio Out 3.5mm USB Type-A for DC 5V Out |
| Control | <ul style="list-style-type: none"> RS232 RJ-45 (support web control)(For Fixed zoom only) |
| Color reproduction | 1073.4 Million color |
| Scan rate | <ul style="list-style-type: none"> Horizontal scan rate: 15.374~91.146 KHz Vertical scan rate: 50~ 85 Hz (120Hz for 3D feature projector) |
| Built-in speaker | 10W |
| Power requirement | 100 - 240V ±10%, AC 50/60Hz |
| Input current | 3.0A |

| Mechanical | Description |
|--------------------------|--|
| Installation orientation | Front, Rear, Ceiling-top, Rear-top |
| Dimensions | <ul style="list-style-type: none"> 337mm x 265mm x 119.3mm (with feet) (13.3" x 10.4" x 4.7") |
| Weight | <ul style="list-style-type: none"> 1080p: 4.6kg (10.1 lbs) XGA/WXGA: 4.2kg (9.3 lbs) |
| Environmental conditions | Operating in 5 ~ 40°C , 10% to 85% humidity (non-condensing) |

Note: All specifications are subject to change without notice.

ADDITIONAL INFORMATION

Regulations and safety notices

FCC notice

This device has been tested and found to comply with the limits for a Class B digital device pursuant to Part 15 of the FCC rules. These limits are designed to provide reasonable protection against harmful interference in a residential installation. This device generates, uses, and can radiate radio frequency energy and, if not installed and used in accordance with the instructions, may cause harmful interference to radio communications.

However, there is no guarantee that interference will not occur in a particular installation. If this device does cause harmful interference to radio or television reception, which can be determined by turning the device off and on, the user is encouraged to try to correct the interference by one or more of the following measures:

- Reorient or relocate the receiving antenna.
- Increase the separation between the device and receiver.
- Connect the device into an outlet on a circuit different from that to which the receiver is connected.
- Consult the dealer or an experienced radio/television technician for help.

Notice: Shielded cables

All connections to other computing devices must be made using shielded cables to maintain compliance with FCC regulations.

Notice: Peripheral devices

Only peripherals (input/output devices, terminals, printers, etc.) certified to comply with the Class B limits may be attached to this equipment. Operation with non-certified peripherals is likely to result in interference to radio and TV reception.

Caution

Changes or modifications not expressly approved by the manufacturer could void the user's authority, which is granted by the Federal Communications Commission, to operate this device.

Operation conditions

This device complies with Part 15 of the FCC Rules. Operation is subject to the following two conditions: (1) this device may not cause harmful interference, and (2) this device must accept any interference received, including interference that may cause undesired operation.

Notice: Canadian users

This Class B digital apparatus complies with Canadian ICES-003.

Remarque à l'intention des utilisateurs canadiens

Cet appareil numérique de la classe B est conforme à la norme NMB-003 du Canada.

Compliant with Russian/ Ukraine regulatory certification



Radio device regulatory notice

Note: The regulatory information below is for models with wireless LAN and/or Bluetooth only.

ADDITIONAL INFORMATION

General

This product complies with the radio frequency and safety standards of any country or region in which it has been approved for wireless use. Depending on configurations, this product may or may not contain wireless radio devices (such as wireless LAN and/or Bluetooth modules).

Canada — Low-power license-exempt radio communication devices (RSS-247)

a Common information

Operation is subject to the following two conditions:

1. This device may not cause interference, and
2. This device must accept any interference, including interference that may cause undesired operation of the device.

b Operation in 2.4 GHz band

To prevent radio interference to the licensed service, this device is intended to be operated indoors and installation outdoors is subject to licensing.

List of applicable countries

This device must be used in strict accordance with the regulations and constraints in the country of use. For further information, please contact the local office in the country of use.

Please see <http://ec.europa.eu/enterprise/rtte/implem.htm> for the latest country list.



Acer Incorporated
8F, 88, Sec. 1, Xintai 5th Rd., Xizhi
New Taipei City 221, Taiwan

EU Declaration of Conformity

We,

Acer Incorporated

8F, 88, Sec. 1, Xintai 5th Rd., Xizhi, New Taipei City 221, Taiwan

And,

Acer Italy s.r.l.

Viale delle Industrie 1/A, 20020 Arese (MI), Italy

Tel: +39-02-939-921 ,Fax: +39-02 9399-2913

www.acer.it

Product: Acer Wireless Projection Kit
Trade Name: Acer
Marketing name: UWA5

We, Acer Incorporated, hereby declare under our sole responsibility that the product described above is in conformity with the relevant Union harmonization legislations: Directive 2014/53/EU on Radio Equipment, RoHS Directive 2011/65/EU. The following harmonized standards and/or other relevant standards have been applied:

| | | |
|---|---|--|
| <input checked="" type="checkbox"/> Electromagnetic compatibility | | |
| <input checked="" type="checkbox"/> EN 55032:2015+AC:2016, Class B | <input checked="" type="checkbox"/> EN 55035:2017 | <input checked="" type="checkbox"/> EN 301 489-17 V3.1.1 |
| <input checked="" type="checkbox"/> EN 61000-3-2:2014 Class D | <input checked="" type="checkbox"/> EN 301 489-1 V2.1.1 | |
| <input checked="" type="checkbox"/> EN 61000-3-3:2013 | <input checked="" type="checkbox"/> EN 301 489-3 V1.6.1 | |
| <input checked="" type="checkbox"/> Radio frequency spectrum usage | | |
| <input checked="" type="checkbox"/> EN 300 328 V2.1.1 | | |
| <input checked="" type="checkbox"/> EN 300 440 v2.2.1 | | |
| <input checked="" type="checkbox"/> EN 301 893 V2.1.1 | | |
| <input checked="" type="checkbox"/> Healthy and Safety | | |
| <input checked="" type="checkbox"/> EN 60950-1:2006/A11:2009/A1:2010/A12:2011/A2:2013 | | |
| <input checked="" type="checkbox"/> EN 62209-2:2010 | <input checked="" type="checkbox"/> EN 62479:2010 | <input checked="" type="checkbox"/> EN 50566:2017 |
| <input checked="" type="checkbox"/> RoHS | | |
| <input checked="" type="checkbox"/> EN 62321:2009 | | |

Operation frequency and radio-frequency power are listed as below:

Bluetooth: 2402-2480MHz < 10 dBm

WLAN 2.4GHz: 2412MHz-2462MHz < 20dBm

WLAN 5GHz: 5180-5320MHz < 23dBm

WLAN 5GHz: 5500-5700MHz < 23dBm

Year to begin affixing CE marking 2019.

RU Jan / Sr. Manager
Acer Incorporated (Taipei, Taiwan)

Aug. 28, 2019
Date



Acer Incorporated
8F, 88, Sec. 1, Xintai 5th Rd., Xizhi
New Taipei City 221, Taiwan

Declaration of Conformity

We,

Acer Incorporated

8F, 88, Sec. 1, Xintai 5th Rd., Xizhi, New Taipei City 221, Taiwan

And,

Acer Italy s.r.l.

Viale delle Industrie 1/A, 20020 Arese (MI), Italy

Tel: +39-02-939-921 ,Fax: +39-02 9399-2913

www.acer.it

Product: DLP Projector
Trade Name: Acer
Model Number: DWU1902/DWX1904/DNX1905/D1P1906/DWX1907/DNX1908
Marketing name: PL1620n/PL1325W/PL1320W/PL1220/SL1520i/SL1320Wn/SL1220n/
FL162/FL221A/FL122/FL112/FL152S/FL122S/FL112S/
LU-P200U/LU-P500WA/LU-P200W/LU-P200X/LU-S200F/LU-S200W/LU-S200X/
PF-L200U/PF-L500WA/PF-L200W/PF-L200X/PS-L200F/PS-L200W/PS-L200X/
LR630/LR335/LR330/LR230/LR530S/LR330S/LR230S/
ML-530/ML-235/ML-230/ML-130/ML-430S/ML-230S/ML-130S

We, Acer Incorporated, hereby declare under our sole responsibility that the product described above is in conformity with the relevant Union harmonization legislations: Directive 2014/53/EU on Radio Equipment, RoHS Directive 2011/65/EU and ErP Directive 2009/125/EC. The following harmonized standards and/or other relevant standards have been applied:

Electromagnetic compatibility

| | | |
|--|--|---|
| <input checked="" type="checkbox"/> EN 55032:2015+AC:2016, Class B | <input checked="" type="checkbox"/> EN 55024: 2010+A1:2015 | <input type="checkbox"/> EN 301 489-7 V1.3.1 |
| <input checked="" type="checkbox"/> EN 61000-3-2:2014 Class D | <input type="checkbox"/> EN 301 489-1 V2.1.1 | <input type="checkbox"/> EN 301 489-17 V3.1.1 |
| <input checked="" type="checkbox"/> EN 61000-3-3:2013 | <input type="checkbox"/> EN 301 489-3 V2.1.1 | <input type="checkbox"/> EN 301 489-24 V1.5.1 |

Radio frequency spectrum usage

| | | |
|--|--|---|
| <input type="checkbox"/> EN 300 328 V2.1.1 | <input type="checkbox"/> EN 302 291-2 V1.1.1 | <input type="checkbox"/> EN 301 908-1 V7.1.1 |
| <input type="checkbox"/> EN 300 440-1 V1.6.1 | <input type="checkbox"/> EN 301 511 V9.0.2 | <input type="checkbox"/> EN 301 908-2 V6.2.1 |
| <input type="checkbox"/> EN 300 440 V2.1.1 | <input type="checkbox"/> EN 301 893 V2.1.1 | <input type="checkbox"/> EN 301 908-13 V6.2.1 |
| <input type="checkbox"/> EN 302 291-1 V1.1.1 | | |

Healthy and Safety

| | | |
|---|---|--|
| <input checked="" type="checkbox"/> EN 60950-1:2006/A11:2009/A1:2010/A12:2011/A2:2013 | <input type="checkbox"/> EN 50360: 2001/A1: 2012 | |
| <input type="checkbox"/> EN 62209-1:2006 | <input checked="" type="checkbox"/> EN 62311:2008 | <input type="checkbox"/> EN 50566:2013 |
| <input type="checkbox"/> EN 62209-2:2010 | <input type="checkbox"/> EN 62479:2010 | |

RoHS

| |
|---|
| <input checked="" type="checkbox"/> EN 50581:2012 |
|---|

ErP

| | |
|---|--|
| <input type="checkbox"/> Regulation (EU) No. 617/ 2013 | <input type="checkbox"/> Regulation (EC) No. 278/2009; EN 50563:2011 |
| <input checked="" type="checkbox"/> Regulation (EC) No. 1275/ 2008; EN 50564:2011 | |

Year to begin affixing CE marking 2019.

RU Jan / Sr. Manager
Acer Incorporated (Taipei, Taiwan)

Aug. 28, 2019
Date



Acer Incorporated
8F, 88, Sec. 1, Xintai 5th Rd., Xizhi
New Taipei City 221, Taiwan

Declaration of Conformity

We,
Acer Incorporated
8F, 88, Sec. 1, Xintai 5th Rd., Xizhi, New Taipei City 221, Taiwan

And,
Acer Italy s.r.l.
Viale delle Industrie 1/A, 20020 Arese (MI), Italy
Tel: +39-02-939-921 ,Fax: +39-02 9399-2913
www.acer.it

Product: DLP Projector
Trade Name: Acer
Model Number: D1P1903
Marketing name: PL1520i/FL152/LU-P200F/PF-L200F/LR530/ML-430/VL6530i

We, Acer Incorporated, hereby declare under our sole responsibility that the product described above is in conformity with the relevant Union harmonization legislations: Directive 2014/53/EU on Radio Equipment, RoHS Directive 2011/65/EU and ErP Directive 2009/125/EC. The following harmonized standards and/or other relevant standards have been applied:

Electromagnetic compatibility

| | | |
|--|--|--|
| <input checked="" type="checkbox"/> EN 55032:2015+AC:2016, Class B | <input checked="" type="checkbox"/> EN 55024: 2010+A1:2015 | <input type="checkbox"/> EN 301 489-7 V1.3.1 |
| <input checked="" type="checkbox"/> EN 61000-3-2:2014 Class D | <input checked="" type="checkbox"/> EN 301 489-1 V2.1.1 | <input checked="" type="checkbox"/> EN 301 489-17 V3.1.1 |
| <input checked="" type="checkbox"/> EN 61000-3-3:2013 | <input checked="" type="checkbox"/> EN 301 489-3 V2.1.1 | <input type="checkbox"/> EN 301 489-24 V1.5.1 |

Radio frequency spectrum usage

| | | |
|---|---|---|
| <input checked="" type="checkbox"/> EN 300 328 V2.1.1 | <input type="checkbox"/> EN 302 291-2 V1.1.1 | <input type="checkbox"/> EN 301 908-1 V7.1.1 |
| <input type="checkbox"/> EN 300 440-1 V1.6.1 | <input type="checkbox"/> EN 301 511 V9.0.2 | <input type="checkbox"/> EN 301 908-2 V6.2.1 |
| <input checked="" type="checkbox"/> EN 300 440 V2.1.1 | <input checked="" type="checkbox"/> EN 301 893 V2.1.1 | <input type="checkbox"/> EN 301 908-13 V6.2.1 |
| <input type="checkbox"/> EN 302 291-1 V1.1.1 | | |

Healthy and Safety

| | |
|---|---|
| <input checked="" type="checkbox"/> EN 60950-1:2006/A11:2009/A1:2010/A12:2011/A2:2013 | <input type="checkbox"/> EN 50360: 2001/A1: 2012 |
| <input type="checkbox"/> EN 62209-1:2006 | <input checked="" type="checkbox"/> EN 62311:2008 |
| <input checked="" type="checkbox"/> EN 62209-2:2010 | <input checked="" type="checkbox"/> EN 50566:2013 |
| <input checked="" type="checkbox"/> EN 62479:2010 | |

RoHS

| |
|---|
| <input checked="" type="checkbox"/> EN 50581:2012 |
|---|

ErP

| | |
|---|--|
| <input type="checkbox"/> Regulation (EU) No. 617/ 2013 | <input type="checkbox"/> Regulation (EC) No. 278/2009; EN 50563:2011 |
| <input checked="" type="checkbox"/> Regulation (EC) No. 1275/ 2008; EN 50564:2011 | |

This radio equipment operates with the following frequency bands and maximum radio-frequency power:

| Frequency bands | GSM | | UMTS | LTE | Bluetooth | WLAN | |
|-------------------------------|---------|-----------|------|-----|-----------|--------|--------|
| | 850/900 | 1800/1900 | | | | 5GHz | 2.4GHz |
| Maximum radio-frequency power | N/A | N/A | N/A | N/A | <20dBm | <23dBm | <20dBm |

Year to begin affixing CE marking 2019.

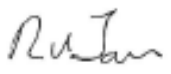
RU Jan / Sr. Manager
Acer Incorporated (Taipei, Taiwan)

Aug. 28, 2019
Date



Acer America Corporation

333 West San Carlos St.,
Suite 1500

San Jose, CA 95110

U. S. A.

Tel: 254-298-4000

Fax: 254-298-4147

www.acer.com



Federal Communications Commission Declaration of Conformity

This device complies with Part 15 of the FCC Rules. Operation is subject to the following two conditions: (1) this device may not cause harmful interference, and (2) this device must accept any interference received, including interference that may cause undesired operation.

The following local Manufacturer / Importer is responsible for this declaration:

| | |
|--------------------------------------|---|
| Product: | DLP Projector |
| Model Number: | DWU1902/D1P1903/DWX1904/DNX1905/ D1P1906/DWX1907/DNX1908 |
| Machine Type: | PL1620n/PL1520i/PL1325W/PL1320W/PL1220/ SL1520i/SL1320Wn/SL1220n/FL162/FL152/FL221A/ FL122/FL112/FL152S/FL122S/FL112S/LU-P200U/ LU-P200F/LU-P500WA/LU-P200W/LU-P200X/ LU-S200F/LU-S200W/LU-S200X/PF-L200U/ PF-L200F/PF-L500WA/PF-L200W/PF-L200X/ PS-L200F/PS-L200W/PS-L200X/LR630/LR530/ LR335/LR330/LR230/LR530S/LR330S/LR230S/ ML-530/ML-430/ML-235/ML-230/ML-130/ ML-430S/ML-230S/ML-130S/VL6530i |
| Name of Responsible Party: | Acer America Corporation |
| Address of Responsible Party: | 333 West San Carlos St. Suite 1500 San Jose, CA 95110 U. S. A. |
| Contact Person: | Acer Representative |
| Phone No.: | 254-298-4000 |
| Fax No.: | 254-298-4147 |