

USER'S GUIDE

TD-2020A
TD-2125N
TD-2135N
TD-2125NWB
TD-2135NWB

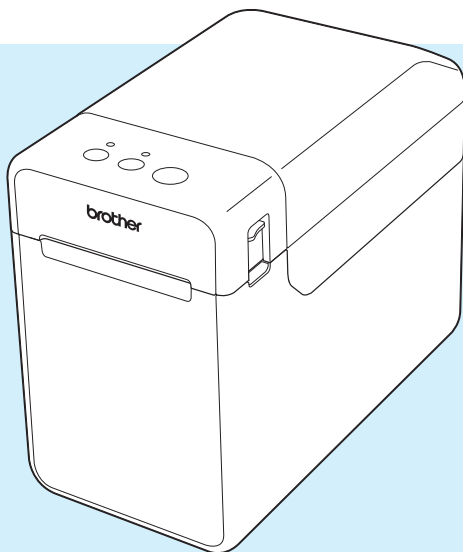

Before using this printer, be sure to read this User's Guide.

We suggest that you keep this manual in a handy place for future reference.

Please visit us at support.brother.com, where you can get product support and answers to frequently asked questions (FAQs).

Introduction

Thank you for purchasing the Brother TD-2020A/2125N/2135N/2125NWB/2135NWB. The TD-2020A/2125N/2135N/2125NWB/2135NWB (hereafter referred to as “the printer”) is a powered desktop thermal printer. Be sure to read the User’s Guide, Product Safety Guide, Quick Reference Guide, Software User’s Guide, and Network User’s Guide (TD-2125N/2135N/2125NWB/2135NWB only) before using the printer. We suggest that you keep these documents in a secure place for future reference.

The following documents are available from our support site (support.brother.com):

- User's Guide
- Software User's Guide
- Network User's Guide (TD-2125N/2135N/2125NWB/2135NWB only)

Symbols Used in This Document

The following symbols are used throughout this document.

CAUTION

This symbol indicates instructions that may result in injuries or damage if they are ignored or incorrectly followed.



This symbol indicates information or directions that should be followed. Ignoring them may result in damage or failed operations.

NOTE

This symbol indicates notes that provide information or directions that can help you better understand and use the product more efficiently.

IMPORTANT NOTICE

For Windows 11 Users:

This printer supports Microsoft Windows 11.

All features in Windows 8.1 and Windows 10 are available in the Windows 11 environment and work in a similar way.

Trademarks

Apple, iPad, iPhone, and Safari are trademarks of Apple Inc., registered in the United States and other countries.

Wi-Fi[®] and Wi-Fi Alliance[®] are registered trademarks of Wi-Fi Alliance[®].

WPA[™], WPA2[™], WPA3[™], and Wi-Fi Protected Setup[™] are trademarks of Wi-Fi Alliance[®].

Android and Google Chrome are trademarks of Google LLC.

The Bluetooth[®] word mark is a registered trademark owned by Bluetooth SIG, Inc. and any use of such marks by Brother Industries, Ltd. is under license. Other trademarks and trade names are those of their respective owners.

Any trade names and product names of companies appearing on Brother products, related documents and any other materials are all trademarks or registered trademarks of those respective companies.

Table of Contents

1	Getting Started	1
	General Description	1
	Power Supply.....	3
	Connecting to an AC Power Outlet.....	3
	Installing the Printer Driver and Software	3
	Registering Paper Size Information With the Printer	4
2	Printing	5
	Operation Panel.....	5
	LED Indicators	5
	Button Functions.....	6
	Inserting the Media Roll	7
	Checking the Sensor Position	9
	Cutting Roll Paper	10
	Printing the Printer Setup Information.....	11
	Connecting the Computer and Printer	13
	USB Cable Connection.....	13
	Wired LAN Connection (TD-2125N/TD-2135N/TD-2125NWB/ TD-2135NWB only)	13
	Wireless LAN Connection.....	14
	Without Using a Wi-Fi Router/Access Point (Wireless Direct).....	15
	Using Infrastructure Mode and Wireless Direct Simultaneously.....	16
	Using Wi-Fi Protected Setup™ (WPS).....	16
	Connect the Printer to a Computer Using a Bluetooth Connection	17
	Printing.....	18
	Making Prints Lighter or Darker.....	18
	Printer Driver Options	19
3	Printer Setting Tool	20
	About the Printer Setting Tool.....	20
	Before Using the Printer Setting Tool	20
	Using the Printer Setting Tool.....	20
	Communication Settings (TD-2125N/TD-2135N/TD-2125NWB/ TD-2135NWB only).....	22
	Settings Dialog Box	22
	Menu Bar	23
	General Tab.....	24
	Wired LAN/Wireless LAN Tabs (TD-2125NWB/TD-2135NWB only).....	24
	Wireless Direct Tab (TD-2125NWB/TD-2135NWB only).....	26
	Bluetooth Tab (TD-2125NWB/TD-2135NWB only)	27
	Applying Setting Changes to Multiple Printers	27
	Device Settings.....	28
	Settings Tabs.....	29
	Menu Bar	34

	P-touch Template Settings	35
	P-touch Template	35
	P-touch Template Settings Dialog Box.....	36
	Paper Size Setup.....	38
	Paper Size Setup Dialog Box	38
	Distributing Paper Formats.....	41
4	Other Functions	42
	Mass Storage Functions.....	42
	Mass Storage Feature	42
	Using the Mass Storage Feature.....	42
	Change Printer Settings Using Web Based Management.....	43
	Software Development Kit	44
5	Maintaining the Printer	45
	Print Head Maintenance	45
	Platen Roller Maintenance.....	45
	Media Exit Maintenance	46
	Label Peeler (Optional) Maintenance (TD-2125N/TD-2135N/TD-2125NWB/ TD-2135NWB only)	46
6	LED Indicators	47
	LED Indicators	47
7	Troubleshooting	49
	Overview.....	49
	Troubleshooting Tips	49
	Error Messages for Touchpanel Display (Optional) (TD-2125N/TD-2135N/TD-2125NWB/TD-2135NWB Only).....	57
8	Specifications	59
	Product Specifications	59
	Product Dimension	61
9	Using the RJ25 to DB9M Serial Adapter (Optional: PA-SCA-001)	63
	Connecting the Computer and Printer With the RJ25 to DB9M Serial Adapter	63
	Product Specifications	63
10	Using the Touchpanel Display (Optional: PA-TDU-001) (TD-2125N/TD-2135N/TD-2125NWB/TD-2135NWB only)	64
	General Description	64
	LCD	64
	Main Screen	64

Touchpanel	65
Information About Replacing the Touchpanel	66
Printing With the Touchpanel Display	67
Touchpanel Display Settings	68
Specifying Settings From the Touchpanel	68
Creating a Label Layout.....	72
Creating a Template	72
Linking a Database to a Template	74
Transferring the Label Layout to the Printer	76
Selecting the Touchpanel	77
Selecting the Data Assigned to Keys on the One-touchpanel.....	78
Creating a One-touchpanel	79
Printing the Label.....	79
Printing Using the Basic Control Panel.....	79
Printing Using the One-touchpanel.....	81
Printing a Different Date/Time Than the Printer's Internal Clock.....	82
Printing Using a Barcode Reader	83
Label Layouts on the Printer (Checking, Deleting and Log)	83
Replacing the Time/Date Battery	84
Frequently Asked Questions.....	85
Product Specifications	86

11 Using the Label Peeler (Optional: PA-LP-001) (TD-2125N/TD-2135N/TD-2125NWB/TD-2135NWB only) 87

Inserting the Media Roll	87
Printer Driver Settings	90
After Printing	91
Product Specifications	91

General Description

Front

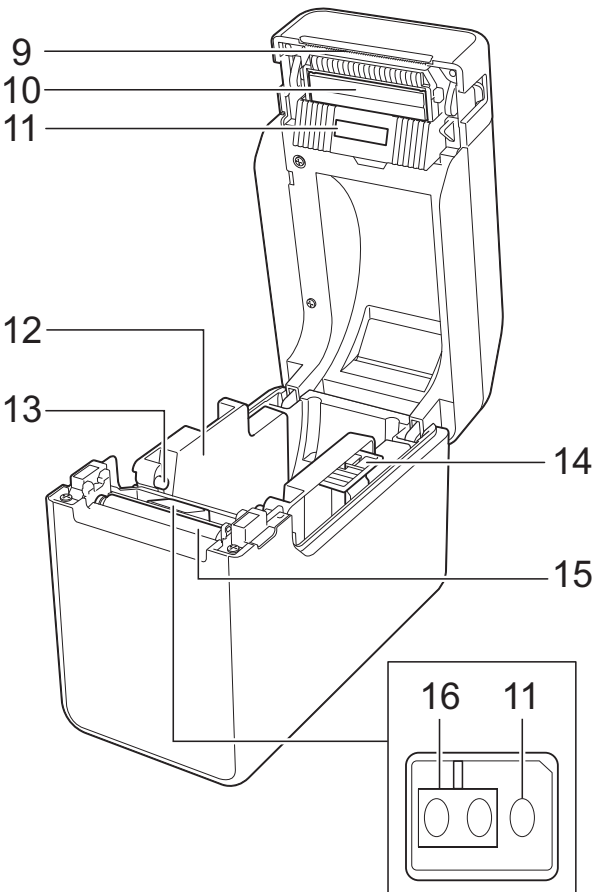
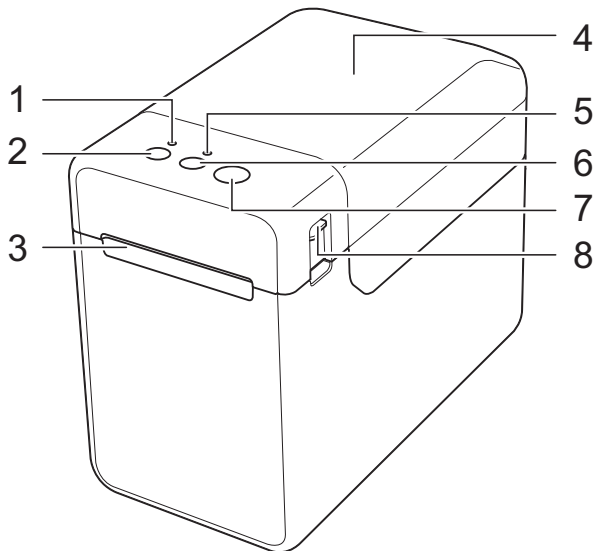

- 1 POWER indicator
- 2 ⏻ (Power) button
- 3 Media exit
- 4 Media Roll compartment top cover
- 5 STATUS indicator
- 6 📄 (Feed) button
- 7 🖨️ (Print) button
- 8 Cover release lever
- 9 Tear bar
 - The Tear Bar Cover is attached to the printer.

NOTE

- Before using the printer, remove the Tear Bar cover, as illustrated.

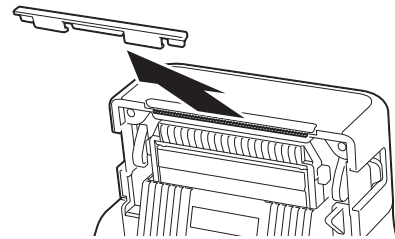

- Do not dispose of the removed cover. To avoid injuries when the printer is not being used, attach the cover to the Tear Bar.

⚠️ CAUTION

The tear bar is sharp. To avoid injury, do not touch the tear bar.

- 10 Print head
- 11 Transmissive/gap sensor
- 12 Media guide
- 13 Media tip guide
- 14 Media guide adjustment lever
- 15 Platen roller
- 16 Reflective/black mark sensor

Back - TD-2020A

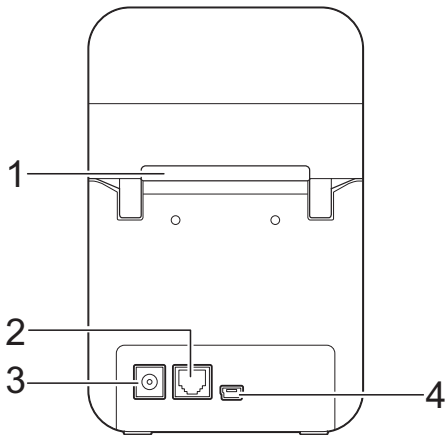

Back - TD-2125NWB/TD-2135NWB

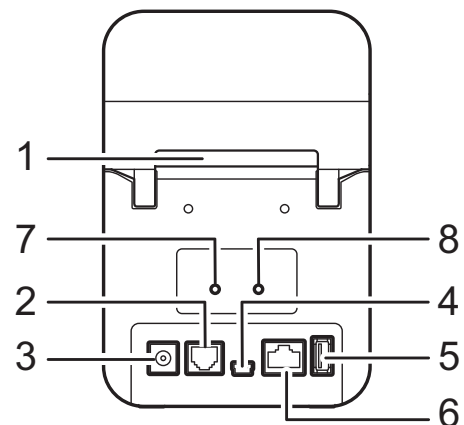

Back - TD-2125N/TD-2135N

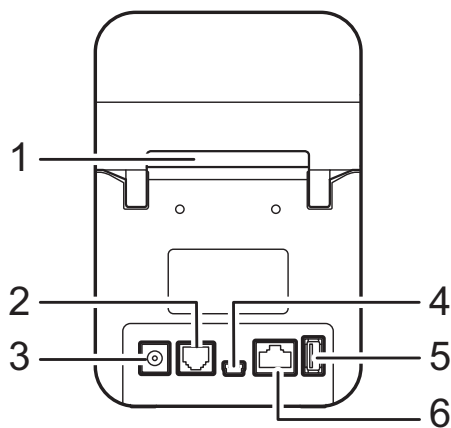

- 1 External media feed slot
- 2 Serial port
- 3 Power connector
- 4 Mini-USB port
- 5 USB host port (TD-2125N/2135N/2125NWB/2135NWB only)
- 6 Ethernet network port (TD-2125N/2135N/2125NWB/2135NWB only)
- 7 Wi-Fi® indicator (TD-2125NWB/2135NWB only)
- 8 Bluetooth® indicator (TD-2125NWB/2135NWB only)

Optional Accessory:

- RJ25 to DB9M serial adapter (PA-SCA-001)

Optional Accessories: (TD-2125N/2135N/2125NWB/ 2135NWB only)

- Touchpanel display (PA-TDU-001)
- Label peeler (PA-LP-001)

Power Supply

This printer operates using the AC Adapter (included).

The AC Adapter supplies power directly to the printer, making it suitable for high-volume printing.

Connecting to an AC Power Outlet



Be sure to unwrap all cords before connecting them.

- 1 Connect the AC Adapter to the printer.
- 2 Connect the AC power cord to the AC Adapter.
- 3 Connect the AC power cord to a nearby AC power outlet (100 - 240 V, 50/60 Hz).
- 4 Press the  (Power) button to turn the printer on. The POWER indicator lights in green, and the printer is in standby.

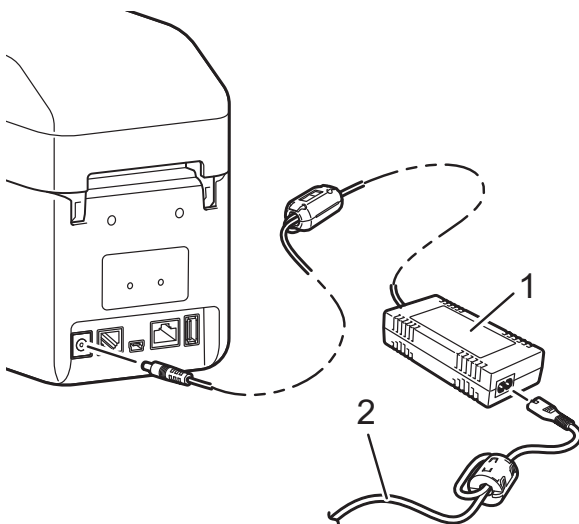

- 1 AC Adapter
- 2 AC power cord

Installing the Printer Driver and Software

Install the printer driver and software using any of the following methods:

- USB cable connection
- Wired LAN connection (TD-2125N/2135N/2125NWB/2135NWB only)
- Wireless LAN connection (TD-2125NWB/2135NWB only)
- Bluetooth Connection (TD-2125NWB/2135NWB only)

Go to support.brother.com to download printer drivers, software, and manuals for your printer, and to view FAQs.

Double-click the downloaded file and follow the on-screen instructions to proceed with the installation.

Registering Paper Size Information With the Printer

The “**Printer Setting Tool**” allows you to register the paper size information for printing.

- 1 Make sure the printer driver is installed and you can print.
- 2 Connect the computer to the printer with a USB cable. This step is necessary only initially to download the settings to the printer.
- 3 Go to the **Printer Setting Tool** and select the **[Paper Size Setup]** option. Specify the size information (label width and length, label spacing, etc.) for the media to be used, and then add the paper format. Settings can also be adjusted for **[Printing Reference Point Adjustment]** and **[Energy Rank]**, and **[Import]** or **[Export]** can be clicked to perform the corresponding operations with the added paper size information list.
- 4 To register the paper size information with the printer, in the **Paper Size Setup** dialog box, click the **Option** button, and then select **Register Paper Size With Printer**. For more information, see *Paper Size Setup* on page 38.

Operation Panel

The operation panel consists of the following buttons and indicators:

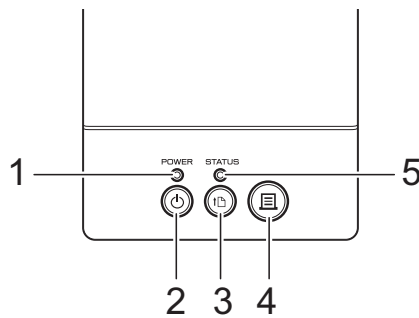

1 **POWER** indicator

2 **⏻ (Power) button**

3 **📄 (Feed) button**

4 **🖨️ (Print) button**

5 **STATUS** indicator

6 **Wi-Fi** indicator

7 **Bluetooth** indicator



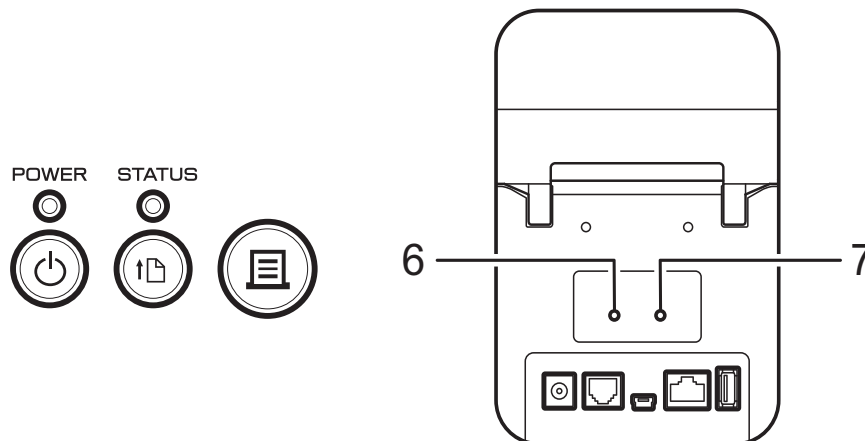

LED Indicators



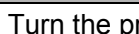
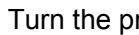

The LED indicators light and blink to indicate the printer's status. Each LED indicator may light or blink in green, red, blue, or orange. For more information, see *LED Indicators* on page 47.

Button Functions

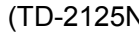
 (Power)	Operation
Turn the printer on	While the printer is turned off, press the  (Power) button. The POWER indicator turns on.
Turn the printer off	While the printer is turned on, press and hold the  (Power) button until the POWER indicator turns off. (If the [Auto Power Off] function is enabled in [Device settings] of the “ Printer Setting Tool > Device settings > Auto Power Off ”, the printer turns off automatically after the specified period of inactivity.)

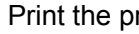
 (Feed)	Operation
Feed the paper	<p>When the paper type is set to [Die-cut Label] or [Media With Marks]: Press the  (Feed) button to automatically feed the paper to the print position.</p> <p>When the paper type is set to [Continuous Length Tape]: Press the  (Feed) button to feed the paper about 1" (25.4 mm). The default setting is [Continuous Length Tape].</p> <p>Use [Paper Size Setup] in the “Printer Setting Tool” to register the paper size information with the printer. For more information, see <i>Registering Paper Size Information With the Printer</i> on page 4.</p>
(TD-2125NWB/2135NWB only) Switch the Wi-Fi, Bluetooth, or both connections	To enable or disable the wireless LAN, Bluetooth, or both connection enable/disable, press and hold the  (Feed) button for five seconds.
(TD-2125NWB/2135NWB only) Setting up Wi-Fi Protected Setup (WPS)	To enable Wi-Fi Protected Setup (WPS), press and hold the  (Feed) button for ten seconds.

 (Print)	Operation
Perform the specified operation	With the printer idle, press this button to perform the operation specified in [Device settings] of the “ Printer Setting Tool ”. For more information, see <i>Print Key Function</i> on page 30.
Print the printer setup information	Make sure that a roll is installed, and then press and hold the  (Print) button for at least one second to begin printing the printer setup information. For more information, see <i>Printing the Printer Setup Information</i> on page 11.
Execute a file stored in the mass storage area	With the printer in mass storage mode, press the  (Print) button to execute a command file stored in the mass storage area.
Reset the incrementing field	Press and hold the  (Print) button for at least five seconds, until the POWER and STATUS indicators blink three times in orange.

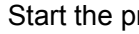
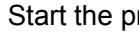
Multiple buttons	Operation
Start the printer in mass storage mode	While pressing the  (Print) button, press and hold the  (Power) button to start the printer in mass storage mode. For more information, see <i>Mass Storage Functions</i> on page 42.

Inserting the Media Roll



We recommend using genuine Brother Media Roll. Genuine Brother fanfold media is not available at this time.

- 1 Press and hold the  (Power) button to turn the printer off. Press the cover release lever (1) on either side and lift to open the Media Roll compartment top cover.

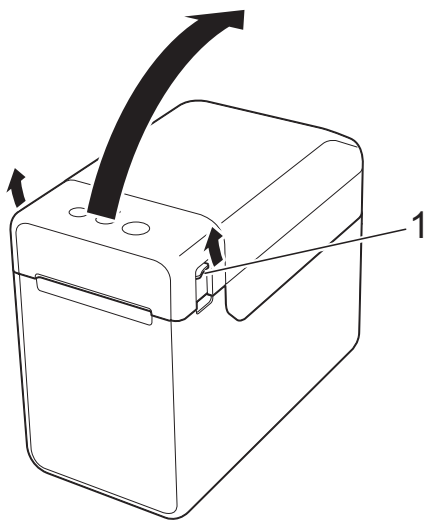

- 2 Open the media guides by lifting the media guide adjustment lever (1) and pulling the media guides outwards.

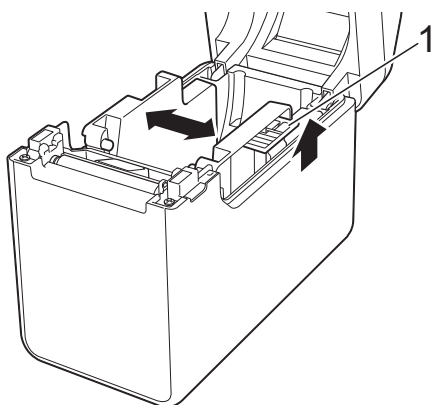

NOTE

The media guides are shipped fully open from the factory.

- 3 Insert the Media Roll into the Media Roll compartment, and then close the Media Roll compartment top cover.

■ For Media Roll

- 1 Insert the Media Roll so that the labels feed with the side to be printed on facing up (1), as shown.

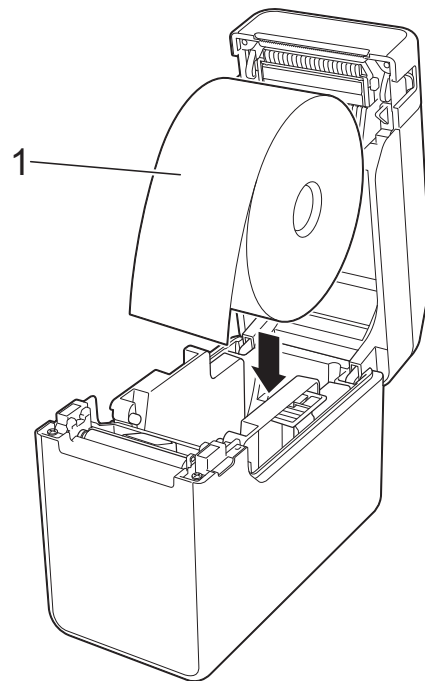

- Use Media Rolls with an outer roll dimension of 5" (127 mm) or less. Use Media Rolls designed for TD series printers. Regardless of the size, some Media Rolls may not be compatible.
- Insert the Media Roll facing the correct direction. If the Media Roll is not inserted correctly, the printer will not print on the correct side of the paper or label.
- When using media with the labels rolled up on the inside, insert the roll in the opposite direction of that shown in sub-step 1 of step 3 so that the print side of the labels will face up.

- 2** While lifting the media guide adjustment lever (1), push in both media guides (2) to fit the width of the paper.

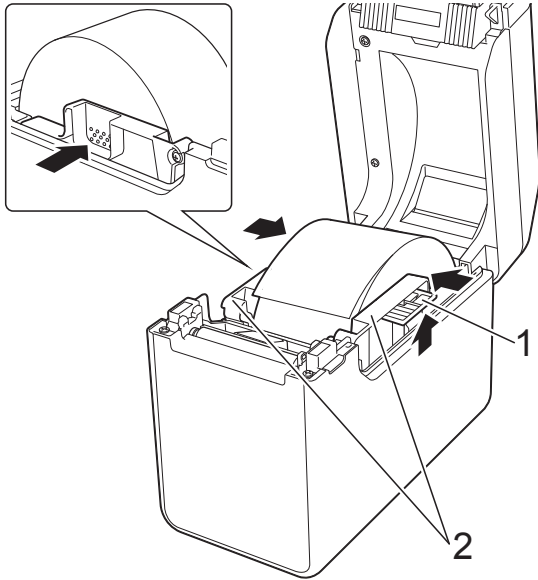

- 3** Feed the end of the Media Roll under the media tip guides (1).

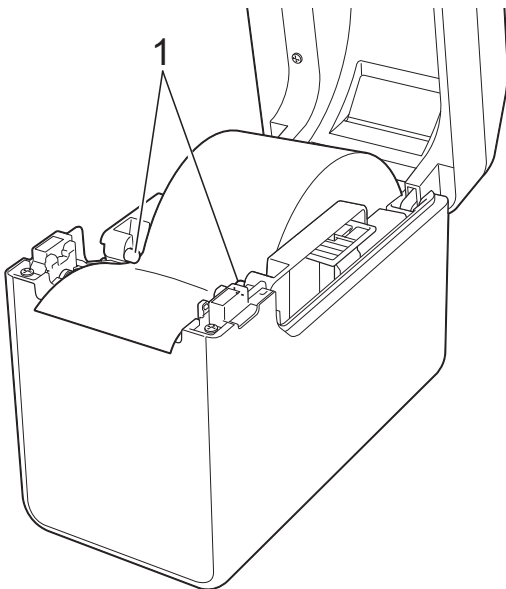

- 4** Position the end of the paper centered over the platen roller and slightly out of the media exit.

- 5** Close the Media Roll compartment top cover by pressing it in the center. Press down until it locks into place.

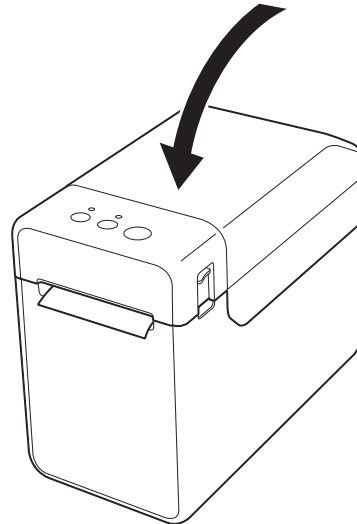

■ For fanfold paper

- 1** Insert the fanfold paper in the direction shown.

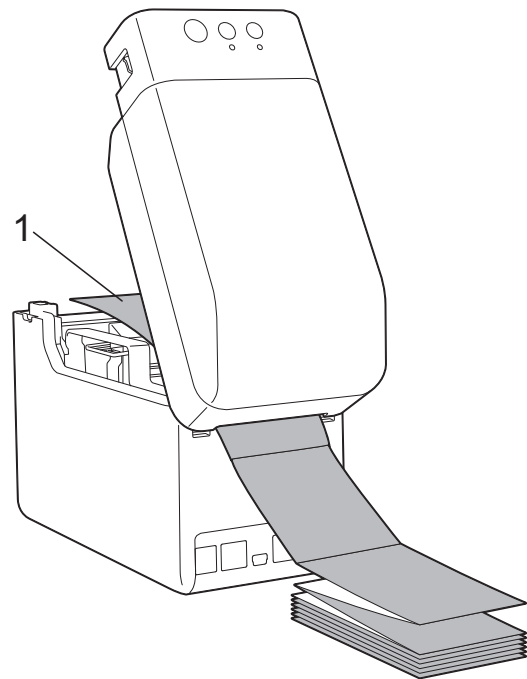

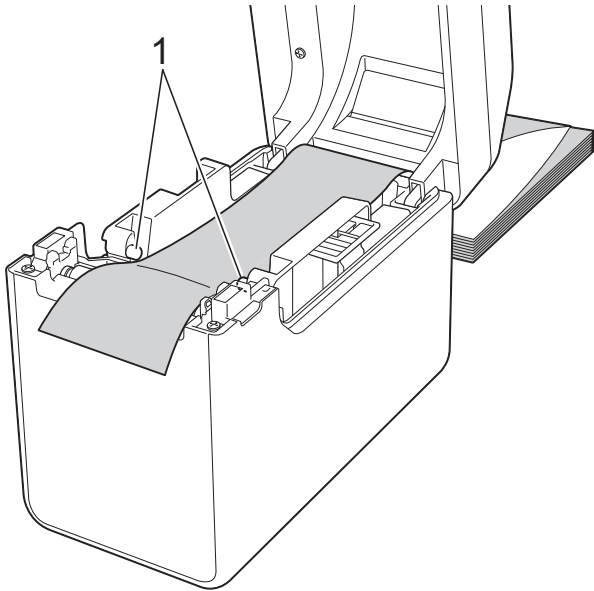

1 Print side

- 2 Feed the end of the fanfold paper under the media tip guides (1).

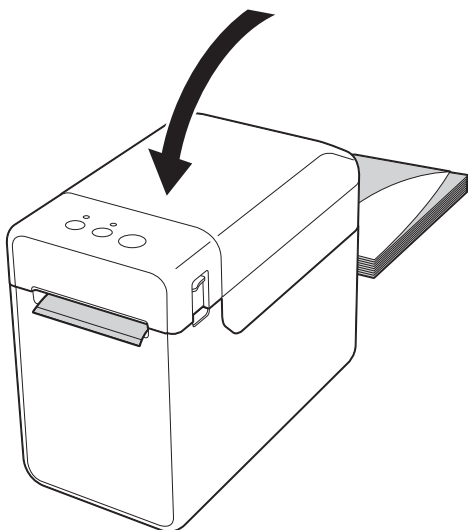

- 3 Position the end of the paper centered over the platen roller and slightly out of the media exit.
- 4 Close the Media Roll compartment top cover by pressing it in the center. Press down until it locks into place.



- 4 Press the  (Power) button to turn the printer on.







NOTE

If the paper size information for the die-cut labels being used has been registered with the printer, pressing the  (Feed) button will position the label at the correct starting position. For more information, see *Registering Paper Size Information With the Printer* on page 4.

Checking the Sensor Position

Check the sensor position for the type of paper being used.

- With die-cut labels that have no black mark, the transmissive/gap sensor detects the beginning of the label and feeds the label to the correct position.
- With receipt paper that has no black mark, the reflective/black mark sensor detects if paper has run out.
- With media that has a black mark, the reflective/black mark sensor detects the mark and feeds the media to the correct position.

With no black mark	
■ Die-cut labels	
Align  on the sensor with  on the printer. (See <i>Figure 1</i> .)	
■ Receipt paper	
Width of 0.985" (25 mm) or more	Align  on the sensor with  on the printer. (See <i>Figure 1</i> .)
Width less than 0.985" (25 mm)	Align  on the sensor with  on the printer. (See <i>Figure 2</i> .)

With a black mark
Align the black mark on the paper with the centerline of the reflective/black mark sensor. (See <i>Figure 3</i> .)
Make sure that there is at least 0.16" (4 mm) of the black mark on the left and right of the centerline for the reflective/black mark sensor.

Figure 1

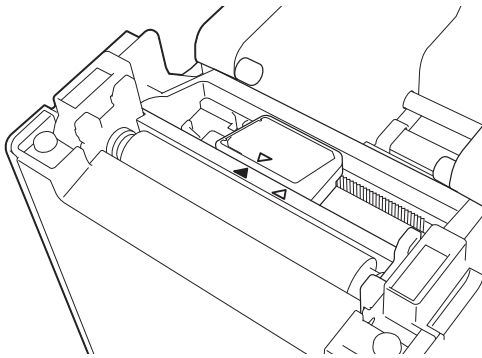

NOTE
This is the sensor's default position.

Figure 2

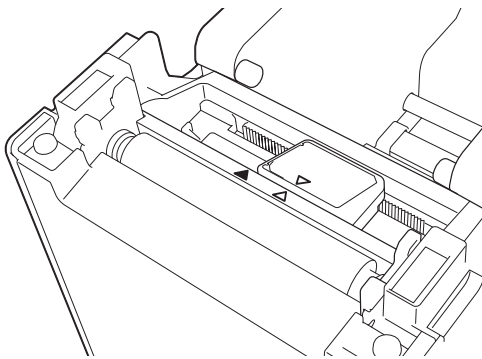
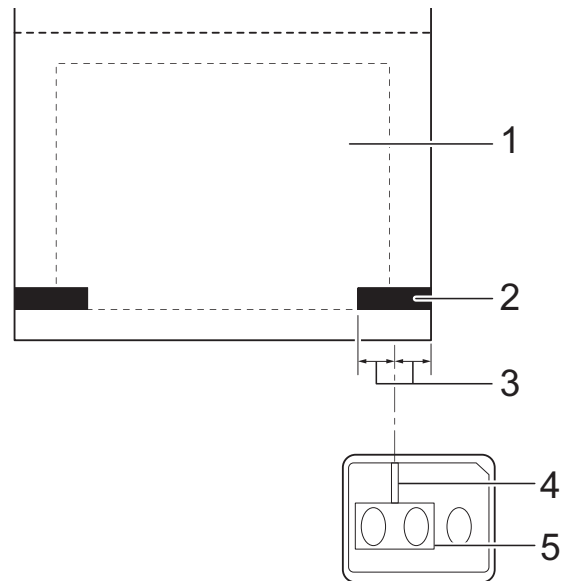

Figure 3



- 1 Back of media
- 2 Black mark
- 3 0.16" (4 mm) or more
- 4 Centerline
- 5 Reflective/black mark sensor

NOTE
When using receipt paper with the maximum width of 2.4" (63 mm), make a black mark at least 0.35" (9 mm) long in from either the left or right edge of the paper so that the reflective/black mark sensor can detect the black mark. If the black mark is too short, it cannot be detected by the reflective/black mark sensor.

Cutting Roll Paper

Roll paper can be cut using the printer's tear bar. Pull one edge of the ejected paper up and diagonally toward the other edge.

⚠ CAUTION

The tear bar is sharp. To avoid injury, do not touch the tear bar.

Printing the Printer Setup Information

Press the  (Print) button to print a report that lists the following printer settings:

- Program version
- Printer usage history
- Missing dot test pattern
- List of transferred data
- Communication settings

NOTE

- You can use [Device settings] of the “Printer Setting Tool” to set, in advance, which items will be printed. For more information, see *Printer Information Report* on page 30.
- The node name will also appear in the communication settings. The default node name is “BRWxxxxxxxxxxxx”. (“xxxxxxxxxxxx” is based on your printer’s MAC address/Ethernet address.)

- 1 Make sure that a roll of 2.25" (57 mm) receipt paper has been loaded, and the Media Roll compartment top cover is closed.
- 2 Turn on the printer.
- 3 Hold down (for at least 1 second) the  (Print) button until the POWER indicator starts blinking in green and the printer setup information is printed.

NOTE

- For printing the printer setup information, we recommend using 2.25" (57 mm) receipt paper. The length required for printing differs depending on the information to be printed.
 - The printer setup information can also be printed from [Device settings] of the “Printer Setting Tool”. For more information, see *Print Information Report* on page 34.
-

Printer Setup Information Printing Sample

```

<<PRINTER CONFIGURATION>>
[Printer]
FormVer =1.00
Printer =TD-2020
PrintID =3335
SerialNo=H2Z345564
Region =US
ProgVer =V0.19
BootVer =V0.05
FontVer =V0.08
EEPROM =V0.010
PrnCt =0000000057
PrnDis =0000000002
RomFree =6288712byte

[Paper]
50mm x 30mm/1.9" x 1.1"
05 32 1E 00 36 24 00 78 01 0D 00 00 00 00 00 00
00 00 00 00 B3 01 00 00 00 00 00 00 00 00 00 00
00 00 00 00 00 00 00 00 00 00 00 00 00 00 00 00
00 00 00 00 00 00 00 00 00 00 00 00 00 00 00 00
00 00 00 00 00 00 00 00 00 00 00 00 35 30 6D 6D
20 78 20 33 30 6D 6D 00 00 00 00 00 00 31 2E 39 22
20 78 20 31 2E 31 22 00 00 00 00 00 00 00 00 08 01
00 00 18 00 00 00 00 00 01 18 00 00 00 00

[ERROR HISTORY(PAGES)]
Last =#01 Check Media
#01 =01(000,012)
#02 =01(000,007)
#03 =00(000,000)
#04 =00(000,000)
#05 =00(000,000)
#06 =00(000,000)
#07 =00(000,000)
#08 =00(000,000)
#09 =00(000,000)
#10 =00(000,000)

[Printer Settings]
Command Mode =P-touch Template
Print Density =+2
Print Priority =Quality
Print Data After Printing =Keep Print Data
Printer Information Reports =All
Feed When Cover Closed =Do not Feed
Power on when Plugged in =Disable
Auto Power Off =None
Default Print# =1
Exit Position =Tear
Print Key =Print Template
Serialize Mode =Cont From Last
Text Direction =Normal
Save Printer Print Log =Enable

```

```

[PDL]
FmtPrefix ='^' (5EH)
CtrPrefix = '~' (7EH)
Delimiter =',' (2CH)

[Template List]
KEY Name Size Date/Time Connected Database Name
-----
1 fruits 2314B 2012/Nov/15 15:37 fruits_datalist
-----

[Database List]
KEY Name Size Date/Time
-----
1 fruits_datalist 174B 2012/Nov/15 15:37
-----

Available memory:6288712B

```

This printing sample is for illustrative purposes only.

Connecting the Computer and Printer

Connect the printer to your computer using any of the methods listed below.

- USB cable connection
- Wired LAN connection (TD-2125N/2135N/2125NWB/2135NWB only)
- Serial cable connection
- Wireless LAN connection (TD-2125NWB/2135NWB only)
- Bluetooth connection (TD-2125NWB/2135NWB only)

USB Cable Connection



Before connecting the printer to the computer, install the printer driver from your model's **Downloads** page at support.brother.com.

2

- 1 Before connecting the USB cable, make sure that the printer is turned off.
- 2 Connect the printer end of the USB cable to the mini-USB port on the back of the printer.
- 3 Connect the other end of the USB cable to the USB port on the computer.

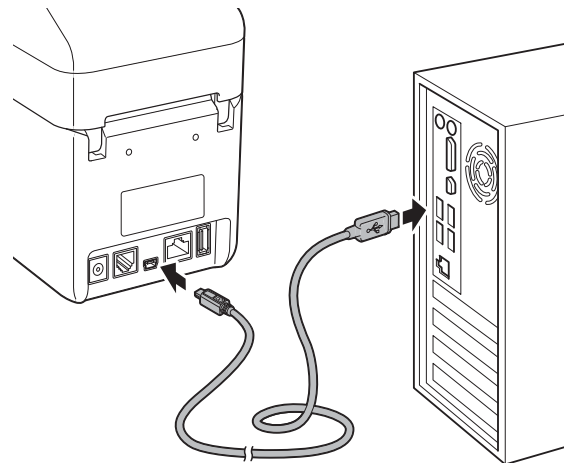

- 4 Turn on the printer.

Wired LAN Connection (TD-2125N/TD-2135N/ TD-2125NWB/TD-2135NWB only)



To use a static IP address to communicate through a wired LAN connection you must first install the printer driver and the **Printer Setting Tool** and specify the wired LAN connection settings. For more information, see *Installing the Printer Driver and Software* on page 3.

- 1 Make sure the printer is turned off before connecting the LAN cable.
- 2 Connect the LAN cable to the ethernet network port on the back of the printer, and then turn on the printer.

NOTE

- Change the printer's communication settings in the **Printer Setting Tool** under **Communication settings**. For more information, see *Communication Settings (TD-2125N/TD-2135N/TD-2125NWB/TD-2135NWB only)* on page 22.
- The **Printer Setting Tool** allows you to change and apply [**Communication settings**] to multiple printers. For more information, see *Applying Setting Changes to Multiple Printers* on page 27.

Wireless LAN Connection

Use any of the following Wi-Fi connection methods:

- Using a Wi-Fi Router/Access Point (Infrastructure Mode)
- Without Using a Wi-Fi Router/Access Point (Wireless Direct)
- Using Infrastructure Mode and Wireless Direct Simultaneously
- Using Wi-Fi Protected Setup (WPS)





Using a Wi-Fi Router/Access Point (Infrastructure Mode)

Infrastructure Mode allows you to connect the printer to a computer or mobile device using a Wi-Fi router/access point.

■ Before You Begin

Configure the printer's Wi-Fi settings to communicate with your Wi-Fi router/access point. After the printer is configured, the computers and mobile devices on your network will have access to the printer.

- Before connecting the printer to your network, contact your system administrator to confirm your Wi-Fi network settings.
- To reconfigure the Wi-Fi settings or if the printer's Wi-Fi connection status is unknown, reset the printer's Wi-Fi settings:

- 1 Press and hold the  (Feed) button and the  (Power) button simultaneously until the POWER indicator lights in orange and the STATUS indicator blinks in green.
- 2 While continuing to press the  (Power) button, press the  (Feed) button twice.
- 3 Release the  (Power) button.

- For the best print results, place the printer as close to the Wi-Fi router/access point as possible with minimal obstructions between them. Large objects or walls between the two devices, as well as interference from other electronic devices, can affect the transfer speed of print data.

■ Connect the printer to your Wi-Fi router/access point

Configure the printer's Wi-Fi settings to communicate with your Wi-Fi router/access point. After the printer is configured, the computers and mobile devices on your network will have access to it.

- 1 Make sure that the printer is turned off.
- 2 Write down the SSID (Network Name) and Password (Network Key) of your Wi-Fi router/access point.
- 3 Connect the printer and computer using a USB cable.

- 4 On the printer, simultaneously press and hold the **Print** (Print), **Feed** (Feed), and **Power** (Power) buttons until the POWER indicator and STATUS indicator blink in green alternately.
- 5 Release the **Feed** (Feed) and **Print** (Print) buttons (keep pressing the **Power** (Power) button).
- 6 Change the connection mode by pressing the **Print** (Print) button (keep pressing the **Power** (Power) button). The flashing indicator changes each time you press the **Print** (Print) button, toggling between connection mode.
- 7 Release the **Power** (Power) button when both the POWER and Wi-Fi indicators are lit in green:
 - Using a Windows computer:
 - a. Launch the “**Printer Setting Tool**” on your computer, and click the **Communication Settings** button.
 - b. Click the **General** tab, and in the **Selected Interface** section, select **Wireless LAN**.
 - c. Click the **Wireless LAN** tab and in the **Wireless Settings** section, select **Infrastructure**.
- 8 Launch the **Printer Setting Tool** on your Windows computer, and click the **Communication Settings** button. Click the **Wireless LAN** tab and select **Wireless Settings**. Type the SSID that you wrote down in step 2, or click **Search** and select the SSID from the list that appears.

- 9 In the **Passphrase** field, type the Password (Network Key).

NOTE

The information required here depends on the authentication method and encryption mode you are using; enter only the information relevant to your network environment.

- 10 Click **Apply**.

Both the POWER and the Wi-Fi indicators will light in green when the connection between the printer and your Wi-Fi router/access point is established.











NOTE

To change any other network settings, use the “**Printer Setting Tool**”.

Without Using a Wi-Fi Router/Access Point (Wireless Direct)

Wireless Direct allows you to connect the printer to your computer or mobile device directly, without a Wi-Fi router/access point. The printer serves as a Wi-Fi access point.

- 1 Make sure that the printer is turned off.
- 2 Confirm the Wireless Direct settings of the Printer.
 - Using a Windows computer:
 - a. Connect the printer and computer using a USB cable.
 - b. Launch the “**Printer Setting Tool**” on your computer, and click the **Communication Settings** button.
 - c. Click the **General** tab and in the **Selected Interface** section, confirm that **Wireless Direct** is selected.

- 3 On the printer, simultaneously press and hold the  (Print),  (Feed), and  (Power) buttons until the POWER indicator and STATUS indicator blink in green alternately.
- 4 Release the  (Feed) and the  (Print) buttons (keep pressing the  (Power) button).
- 5 You can change the connection mode by pressing the  (Print) button (keep pressing the  (Power) button). The flashing indicator changes each time you press the  (Print) button and it toggles between the connection modes.
- 6 Release the  (Power) button when the Power and Wi-Fi indicators are both lit in green.
- 7 Use your computer or mobile device to select the SSID of the printer (“DIRECT-*****_TD-2135NWB”). If required, type the Password (“213*****”, where***** is the last five digits of the printer's serial number).

NOTE

- The serial number label is located on the base of the printer. If necessary, confirm the serial number by printing the printer information.
- Use the “**Printer Setting Tool**” to change the printer's network settings.
- Use the “**Printer Setting Tool**” to apply network settings to multiple printers at the same time.
- You cannot connect to the Internet via Wi-Fi while using Wireless Direct. To use the Internet, connect using a Wi-Fi router/access point (Infrastructure Mode).
- We recommend setting a new Wireless Direct password using the “**Printer Setting Tool**” to protect your printer from unauthorized access.

Using Infrastructure Mode and Wireless Direct Simultaneously

Wireless Direct allows you to connect the printer to your computer or mobile device directly, without a Wi-Fi router /access point. The printer serves as a Wi-Fi access point.

- 1 Set the printer to Infrastructure Mode and Wireless Direct.
 - Using a Windows computer:
 - a. Launch the “**Printer Setting Tool**” on your computer.
 - b. Click the **Communication Settings** button.
 - c. Click **General > Communication Settings**.
 - d. Confirm that the **Infrastructure and Wireless Direct** option is selected for the **Selected Interface** setting.

Using Wi-Fi Protected Setup™ (WPS)

- 1 Confirm that your Wi-Fi router/access point has the WPS symbol. If this symbol is not visible, you must use a different connection method.



- 2 Place the printer within the range of your Wi-Fi router/access point. The range may differ depending on your environment. See the instructions provided with your Wi-Fi router/access point.
- 3 Press and hold  (Feed) button for ten seconds until STATUS indicator blinks in green.

- 4 Press the WPS button on your Wi-Fi router/access point. When the connection is established, the STATUS indicator is lit in green.

For more information, see the instructions provided with your Wi-Fi router/access point. Both the POWER and the Wi-Fi indicators will light in green when the connection is established.









Computers and mobile devices that are on the same network as the printer will have access to the printer.

NOTE

If your computer or mobile device supports the PIN authentication method, select **[PIN Code]** for better security.

Connect the Printer to a Computer Using a Bluetooth Connection

Follow the manufacturer's recommendations for your Bluetooth-equipped devices (computers and mobile devices) or Bluetooth adapter, and install any necessary hardware and software.

- 1 Make sure that the printer is turned off.
- 2 Simultaneously press and hold the  (Print),  (Feed), and  (Power) buttons until the POWER indicator and STATUS indicators blink in green alternately.
- 3 Release the  (Feed) and  (Print) button (keep pressing the  (Power) button).
- 4 You can change the connection mode by pressing the  (Print) button (keep pressing the  (Power) button).
- 5 To set Bluetooth mode, release the  (Power) button when the STATUS indicator is lit in green and the Bluetooth indicator is lit in blue.

- 6 Use your Bluetooth management software to discover the printer. Select the printer name (where XXXX is the last four digits of the printer's serial number). You can find the serial number label on the base of the printer.

NOTE

- You can also change the printer's communication settings using the "**Printer Setting Tool**".
- If the passcode appears on the LCD while connecting, check that it is the same as that of the computer or mobile device, and then press the **OK** button.
- We recommend setting a new Bluetooth PIN code using the "**Printer Setting Tool**" to protect your printer from unauthorized access.

Printing

There are various methods for printing with this printer. The following describes the procedure for printing from a computer.

- 1 Start the P-touch Editor application, and then open the document to be printed. For more information on using P-touch Editor, refer to the *Software User's Guide* on your model's **Manuals** page at support.brother.com/manuals.
- 2 Make sure the printer is connected to an AC power outlet.
- 3 Turn on the printer. The POWER indicator lights in green.

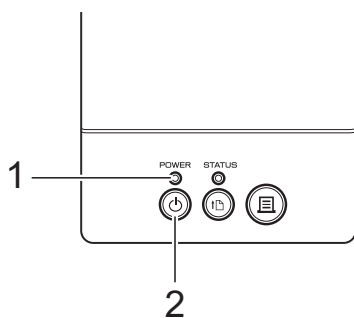

1 **POWER** indicator

2  (Power) button

- 4 Connect the printer to a computer. For more information on the connection methods and procedures, see *Connecting the Computer and Printer* on page 13.
- 5 Insert the Media Roll. For more information, see *Inserting the Media Roll* on page 7. We recommend to use genuine Brother Media Roll.
- 6 If necessary, change the print settings using either the printer driver or the *Printer Setting Tool* instructions starting on page 20.

- 7 Click [**Print**] in the computer program's menu.

The POWER indicator blinks in green to indicate that the printer is receiving data, and the document prints.

Making Prints Lighter or Darker

You can make prints lighter or darker by adjusting the print density setting in the printer driver's dialog box or the "**Printer Setting Tool**". (See *Print Density* on page 30)

Printer Driver Options

You can configure various settings in the printer driver's dialog box, such as paper size, number of copies, print quality, etc.

NOTE

You can also use the “**Printer Setting Tool**” to configure more advanced settings.

For more information, see *Printer Setting Tool* on page 20.

3

Printer Setting Tool

About the Printer Setting Tool

Use the **Printer Setting Tool** to specify the printer's communication settings, device settings, P-touch Template settings, and paper size settings from your computer.

NOTE

The **Printer Setting Tool** is automatically installed when you download and install other software, including the printer driver, from our support website.

 The **Printer Setting Tool** is available only with compatible Brother printers.

Before Using the Printer Setting Tool

- Make sure the printer is connected to an AC power outlet.
- Make sure that the printer driver has been installed and is functional.
- Connect this printer to a computer using a USB cable.

With this tool, settings cannot be specified using a wired LAN, wireless LAN, or Bluetooth connection.

 Use the **Printer Setting Tool** to configure the printer only when the printer is in standby. The printer may malfunction if you attempt to configure it while printing.

Using the Printer Setting Tool

- 1 Connect the printer you want to configure to your computer.
- 2 Launch the Printer Setting Tool.
For Windows 10:
From the Start menu, click **Brother** > **Printer Setting Tool**.

For Windows 8.1:
Click the **Printer Setting Tool** icon in the **Apps** screen.

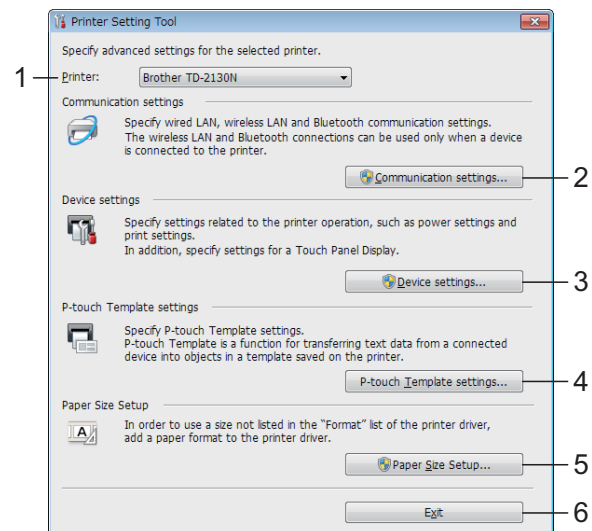

- 1 **Printer**
Select the printer you want to configured. If only one printer is connected, it is unnecessary to make a selection since only that printer will appear.

2 Communication settings

For TD-2125N / TD-2135N /

TD-2125NWB / TD-2135NWB only:
Specify wired LAN settings.

For TD-2125NWB / TD-2135NWB only:
Specify wireless LAN, or Bluetooth
communication settings.



You must log on as an administrator to access [**Communication settings**].

3 Device settings

Specify printer device settings, such as
power settings and print settings.

For TD-2125N / TD-2135N /
TD-2125NWB / TD-2135NWB only,
settings can also be specified using the
touchpanel.



You must log on as an administrator to access [**Device settings**].

4 P-touch Template settings

Specify P-touch Template settings.

5 Paper Size Setup

Add media information and settings to
the printer driver in order to use paper
sizes that may not be included in the
printer driver.



You must log on as an administrator to access [**Paper Size Setup**].

6 Exit

Closes the window.

- 3** Check that the printer to be configured appears beside [**Printer**]. If a different printer is displayed, select the desired printer from the drop-down list.
- 4** Make the settings changes you want. For more information on settings, see *Communication Settings (TD-2125N/ TD-2135N/ TD-2125NWB/ TD-2135NWB only)* on page 22, *Device Settings* on page 28, *P-touch Template Settings* on page 35 or *Paper Size Setup* on page 38.

- 5** When finished, click **Apply** to apply the new printer settings, and then click **Exit**.
- 6** Click **Exit** in the main window to save the printer settings.

Communication Settings (TD-2125N/ TD-2135N/ TD-2125NWB/ TD-2135NWB only)

Use [Communication settings] in the “Printer Setting Tool” to specify or change printer communication information when connecting the printer and computer with a USB cable. You can change the communication settings for one printer and easily apply the same settings to multiple printers.

Settings Dialog Box

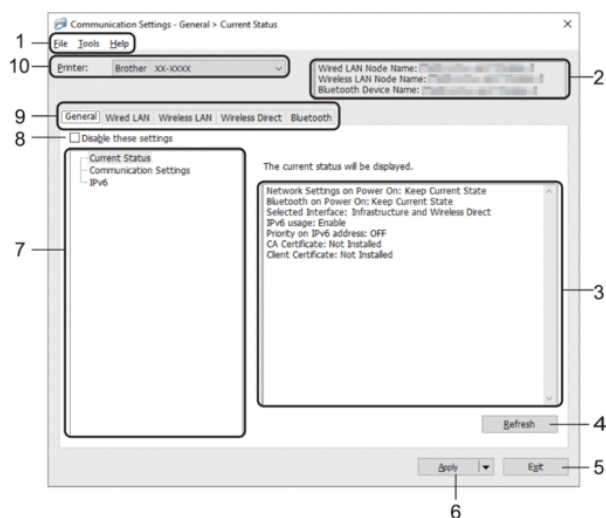

1 Menu Bar

Provides access to various commands grouped under each menu title (the **File**, **Tools**, and **Help** menus) according to their functions.

2 Node Name

Displays the node name. The node name can also be changed. (See *Change Node Name/Bluetooth Device Name* on page 24)

3 Settings Display/Change Area

Displays the current settings for the selected item.

4 Refresh

Update the displayed settings with the most recent information.

5 Exit

Exits [Communication settings], and returns to the main window of the “Printer Setting Tool”.



Settings changes will not be applied without clicking the [Apply] button. After changing settings, be sure to click [Apply] before clicking [Exit].

6 Apply

Apply the settings to the printer.

To save the specified settings in a command file, select [Save in Command File] from the drop-down menu. The saved command file can be used with the mass storage feature to apply the settings to a printer. (See *Mass Storage Functions* on page 42)



Clicking [Apply] applies all changes made in all tabs.

If the [Disable these settings] check box is selected, the settings in that tab will not be applied.

7 Items

When [Current Status] is selected, the current settings appear in the settings display/change area.

Select the item for the settings that you want to change.

8 Disable these settings

When this check box is selected,  appears in the tab, and the settings can no longer be specified or changed.

Settings in a tab where  appears are not applied to the printer even when you click [Apply]. In addition, the settings in the tab are not saved or exported when the [Save in Command File] or [Export] command is executed.

To apply the settings to the printer or save or export them, be sure to clear this check box.

9 Settings Tabs

Contains settings that may be specified or changed.

If  appears in the tab, the settings are not applied to the printer.

10 Printer

Lists the connected printers.



Menu Bar

File Menu Options

- **Apply Settings to the Printer**
Applies the settings to the printer.
- **Save Settings in Command File**
Saves the specified settings in a command file. The file extension is “.bin”.
The saved command file can be used with the mass storage feature to apply the settings to a printer. (See *Mass Storage Functions* on page 42)

NOTE

If the [**Disable these settings**] check box is selected, the settings in the tab will not be saved.

	<ul style="list-style-type: none"> ■ The following information is not saved with the settings commands: <ul style="list-style-type: none"> • Node name • IP address, subnet mask, and default gateway (when the IP address is set to [STATIC])
	<ul style="list-style-type: none"> ■ The saved communication settings commands are intended to be used only for applying settings to a printer. The settings cannot be applied by importing this command file. ■ Saved command files contain authentication keys and passwords. Take necessary measures to protect saved command files, such as by saving them in a location that cannot be accessed by other users. ■ Do not send the command file to a different printer model.

- **Import**
 - **Import from the current computer wireless settings (TD-2125NWB/2135NWB only)**
Imports the settings from the computer.

NOTE

- Only personal security authentication settings (open system, public key authentication, and WPA/WPA2-PSK/WPA3-SAE) can be imported. Enterprise security authentication such as EAP-FAST settings cannot be imported.
- If multiple wireless LANs are enabled for the computer you use, the first detected wireless settings (only personal settings) that are detected will be considered for the import data.
- Only settings (communication mode, SSID, authentication method, encryption mode, and authentication key) from the [**Wireless Settings**] pane in the [**Wireless LAN**] tab can be imported.

■ Select a Profile to import

Imports the exported file and applies the settings to a printer.

Click [**Browse**] and select the file you want to import. The settings in the selected file appear in the settings display/change area.

NOTE

- All settings except for node names can be imported.
- Only profiles that are compatible with the selected printer can be imported.
- If the imported profile's IP address is set to [**STATIC**], change the IP address of the imported profile so that it does not duplicate the IP address of an existing printer on the network.

• Export

Saves the current settings in a file.

NOTE

If the [**Disable these settings**] check box is selected, the settings in the tab will not be saved.

	Exported files are not encrypted.
---	-----------------------------------

Tools Menu Options

- **Automatically restart the printer after applying new settings**

If you select this check box, the printer automatically restarts after communication settings are applied.

If you clear this check box, you must restart the printer manually.

NOTE

When configuring multiple printers, you can reduce the time required to change settings by clearing this check box. In this case, we recommend selecting this check box when configuring the first printer so that you can confirm that each setting is operating as intended.

- **Automatically detects the connected printer, and retrieves the current settings.**

If this check box is selected and a printer is connected to the computer, the printer is automatically detected and the printer's current settings are displayed in the [Current Status] pane.

NOTE

If the connected printer is different from the printer shown in the **Printer** drop-down list the settings available on all tabs change to match the connected printer.

- **Change Node Name/Bluetooth Device Name**
Allows each node name to be changed.
- **Reset to Default Communication Settings**
Returns the communication settings to their factory defaults.

Help Menu Options

- **Display Help**
Displays Help and information about communication settings.

General Tab

Communication Settings

- **Network Settings on Power On**
(TD-2125NWB/2135NWB only)
Specify the conditions for connecting via network when the printer is turned on. Select the **Wireless LAN by Default**, **Wired LAN by Default**, or **Keep Current State** option.
- **Selected Interface**
(TD-2125NWB/2135NWB only)
Select the **Infrastructure**, **Infrastructure and Wireless Direct**, or **Wireless Direct** option.
- **Bluetooth on Power On (TD-2125NWB/2135NWB only)**
Specify the conditions for connecting via Bluetooth when the printer is turned on. Select the **On by Default**, **Off by Default**, or **Keep Current State** option.

IPv6

- **IPv6 usage**
Select **Enable** or **Disable**.
- **Priority on IPv6 address**
Select to give priority to an IPv6 address.

Wired LAN/Wireless LAN Tabs (TD-2125NWB/TD-2135NWB only)

TCP/IP TCP/IP (Wireless)

- **Boot Method**
Select the **AUTO**, **BOOTP**, **DHCP**, **RARP**, or **STATIC** option.
- **IP Address/Subnet Mask/Gateway**
Specify the various networking values. You can enter these settings only when the IP address is set to **STATIC**.
- **DNS Server Method**
Select the **AUTO** or **STATIC** option.
- **Primary DNS Server IP Address/Secondary DNS Server IP Address**
Enter these settings only when the DNS server is set to **STATIC**.

IPv6

- **Static IPv6 Address**
Specify a permanent IPv6 address.
- **Enable this address**
Enables the specified static IPv6 address.
- **Primary DNS Server IPv6 Address/
Secondary DNS Server IPv6 Address**
Specify the DNS server IPv6 addresses.
- **IPv6 Address List**
Displays the list of IPv6 addresses.

Wired 802.1x Authentication

Configure IEEE 802.1x authentication.

- **Wired 802.1x Status**
Enable or disable IEEE 802.1x authentication for wired networks.
- **Authentication Method**
Select the authentication method.
- **User ID/Password**
With EAP-TLS, it is not necessary to register a password, but you must register a client certificate. To register a certificate, connect to the printer from a web browser, and then specify the certificate. You can also install the authentication certificate in the Printer Setting Tool using the menu bar: **File > Install Certificates**.

Wireless Settings

- **Communication Mode**
Displays the available communications modes.
- **SSID (Network Name)**
Click **Search** to display available SSIDs.
- **Channel**
Displays the automatically selected channel.
- **Authentication Method/Encryption Mode**
The supported encryption modes for the authentication methods are shown in the table below.

Authentication Method	Encryption Mode
Open System	None
	WEP
Shared Key	WEP
WPA3-SAE	AES
WPA/WPA2-PSK/ WPA3-SAE	TKIP + AES
	AES
EAP-FAST/NONE	TKIP
	AES
EAP-FAST/ MS-CHAPv2	TKIP
	AES
EAP-FAST/GTC	TKIP
	AES
PEAP/MS-CHAPv2	TKIP
	AES
PEAP/GTC	TKIP
	AES
EAP-TTLS/CHAP	TKIP
	AES
EAP-TTLS/MS-CHAP	TKIP
	AES
EAP-TTLS/MS-CHAPv2	TKIP
	AES
EAP-TTLS/PAP	TKIP
	AES
EAP-TLS	TKIP
	AES



To perform higher level security settings:

When performing certificate verification with EAP-FAST, PEAP, EAP-TTLS, or EAP-TLS authentication methods, you cannot specify the certificate from the Network Setting Tool. After the printer is set up to connect to the network, specify the certificate by accessing the printer from a web browser.

For more information on using a web browser, see *Change Printer Settings Using Web Based Management* on page 43.

- **WEP Key**
Specify a setting only when WEP is selected as the encryption mode.
- **Passphrase**
Specify a setting only when WPA3-SAE or WPA/WPA2-PSK/WPA3-SAE is selected as the authentication method.
- **User ID/Password**
Specify these settings only when EAP-FAST, PEAP, EAP-TTLS, or EAP-TLS is selected as the authentication method.
With EAP-TLS, it is not necessary to register a password, but a client certificate must be registered. To register a certificate, connect to the printer from a web browser, and then specify the certificate.
- **Display the key and password on-screen**
If you select this check box, keys and passwords are displayed in plain (non-encrypted) text.

Wireless Direct Tab (TD-2125NWB/TD-2135NWB only)

Wireless Direct Settings

- **SSID/Network Key Generation**
Select the **AUTO** or **STATIC** option.
- **SSID (Network Name)/Network Key**
Specify the SSID (25 ASCII characters or fewer) and the Network Key (63 characters or fewer) you want to use in the Wireless Direct mode.

NOTE

- The default SSID and Password are as follows:
 - SSID: "DIRECT-*****_TD-2125NWB / DIRECT-*****_TD-2135NWB" where ***** is the last five digits of the printer's serial number.
 - Password: 212***** (for TD-2125NWB) 213***** (for TD-2135NWB) where ***** is the last five digits of the printer's serial number.
 - The serial number label is located on the base of the printer.
-

- **Channel**
Specify the channel to use for the Wireless Direct mode.

Bluetooth Tab (TD-2125NWB/ TD-2135NWB only)

Bluetooth Settings

Bluetooth Mode

Select the control mode when Bluetooth is enabled.

Classic

- **Visible to Other Devices**
Allow the printer to be “discovered” by other Bluetooth devices.
- **Change PIN code**
Change the PIN.
- **Display the PIN code on-screen**
Display the PIN on your computer.
- **Pairing requires user confirmation on the printer**
If you select this check box, when using Classic Bluetooth mode, you must perform additional printer button operations to pair with devices running Bluetooth 2.1 or later.
- **Auto re-pairing**
Set whether to automatically reconnect to a previously connected Apple device (iPad, iPhone, or iPod touch).

Low Energy

- **Minimum Security Mode**
Select the minimum security level when using the **Low Energy Only** mode.
- **Pairing requires user confirmation on the printer**
If you select this check box, when using the **Low Energy Only** mode, you must perform additional printer button operations to pair with Low Energy compatible devices.

Applying Setting Changes to Multiple Printers

- 1 After applying settings to the first printer, disconnect the printer from the computer, and then connect the second printer to the computer.
- 2 Select the newly connected printer from the **[Printer]** drop-down box.

NOTE

If the **[Automatically detects the connected printer, and retrieves the current settings.]** check box in the **[Option Settings]** dialog box is selected, the printer connected with the USB cable is automatically selected.

For details, see *Automatically detects the connected printer, and retrieves the current settings.* on page 24.

- 3 Click the **[Apply]** button.
The same settings that were applied to the first printer are applied to the second printer.

NOTE

If the **[Automatically restart the printer after applying new settings]** check box is cleared, the printers will not be restarted after the settings are changed, reducing the time required to configure the printers. However, we recommend selecting the **[Automatically restart the printer after applying new settings]** check box when configuring the first printer so that you can confirm that a connection with the access point can be correctly established with the settings. For details, see *Automatically restart the printer after applying new settings* on page 24.

- 4 Repeat steps 1 – 3 for all the printers whose settings you wish to change.

	<p>If the IP address is set to [STATIC], the printer's IP address will also be changed to the same address as the first printer. Change the IP address if necessary.</p>
---	---

NOTE

To save the current settings in a file, click **[File] - [Export]**.

The same settings can be applied to another printer by clicking **[File] - [Import]**, then selecting the exported settings file. (See *Import* on page 23)

Device Settings

With **[Device settings]** in the “**Printer Setting Tool**”, default printer settings as well as settings for the touch panel display (optional, TD-2125N/2135N/2125NWB/2135NWB only) can be changed.

When printing from a computer application, various printing settings can be specified from the printer driver; however, by using **[Device settings]** in the “**Printer Setting Tool**”, more advanced settings can be specified.

When **[Device settings]** is opened, the printer's current settings are retrieved and displayed. If the current settings could not be retrieved, the previous settings are displayed. If the current settings could not be retrieved and previous settings have not been specified, this tool's default settings are displayed.

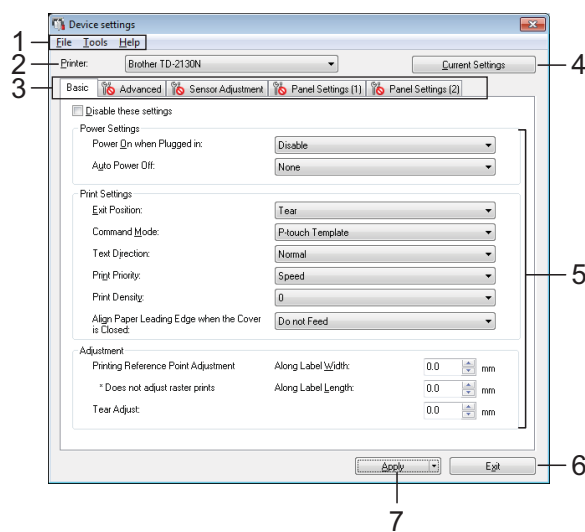

1 Menu Bar

Select a command contained in each menu from the list.

2 Printer

Select the printer whose device settings are to be specified.

If only one printer is connected, it is unnecessary to make a selection since only that printer will appear.

3 Settings Tabs

Click the tab containing the settings to be specified or changed.

NOTE

- If  appears in the tab, the settings in that tab cannot be specified or changed. In addition, the settings in the tab will not be applied to the printer even if **[Apply]** is clicked. The settings in the tab will also not be saved or exported when the **[Save in Command File]** or **[Export]** command is executed.
- “**Panel Settings (1)**” and “**Panel Settings (2)**” appear only if TD-2125N/2135N/2125NWB/2135NWB is selected for **[Printer]**. Specify the settings when the touch panel display (optional) is used.

4 Current Settings

Click this button to retrieve the settings from the currently connected printer and display them in the dialog box. Settings will also be retrieved for parameters on tabs with .

NOTE

When the **[Current Date/Time]** button is clicked, the current time is retrieved from the computer and displayed for **[Set Clock]** in the “**Panel Settings (2)**” tab. (In order to specify the clock settings, the touch panel display must be attached.)

5 Parameters

Displays the current settings. Change the settings as necessary using the drop-down menus, direct entry or other appropriate methods.

6 Exit

Exits **[Device settings]**, and returns to the main window of the “**Printer Setting Tool**”.

7 Apply

Click **[Apply]** to apply the settings to the printer. To save the specified settings in a command file, select **[Save in Command File]** from the drop-down menu.

The saved command file can be used with the mass storage feature to apply the settings to a printer. (See *Mass Storage Functions* on page 42)

Settings Tabs

Basic Tab

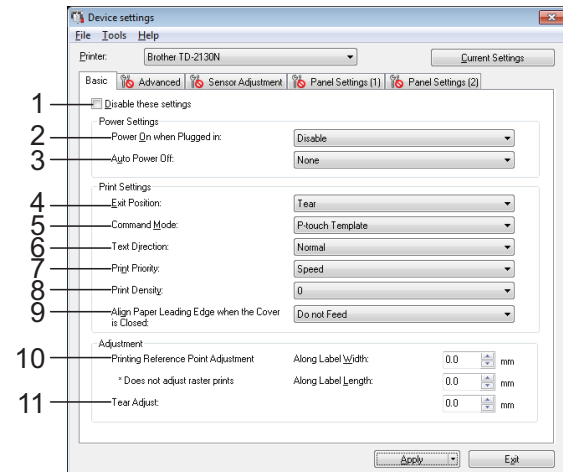

1 Disable these settings

When this check box is clicked,  appears in the tab, and the settings can no longer be specified or changed.

The settings in a tab where  appears will not be applied to the printer even if **[Apply]** is clicked. In addition, the settings in the tab will not be saved or exported when the **[Save in Command File]** or **[Export]** command is executed.

To apply the settings to the printer or save or export them, be sure to clear the check box.

2 Power On when Plugged in

Select whether or not the printer turns on automatically when the AC power cord is plugged into an AC power outlet.

Available settings: **[Enable]**, **[Disable]**

3 Auto Power Off

Specify the amount of time that passes before the printer turns off automatically.

Available settings: **[None]**, 10 min. to 60 min. (10 min. increments)

4 Exit Position (TD-2125N/2135N/2125NWB/2135NWB only)

Select the media output location.

Available settings: **[Tear]**, **[Peeler]**

5 Command Mode

Select the printer's command format.

Available settings: **[Raster]**, **[ESC/P]**, **[P-touch Template]**

6 Text Direction

Select the printing orientation.

Available settings: **[Normal]**, **[Inverted 180 Degrees]**

This setting is applied only if the printer driver is not used. If the printer driver is used, the setting specified in the printer driver will be applied.

7 Print Priority

Select the printer's print quality.

Available settings: **[Quality]**, **[Speed]**

NOTE

[Print Priority] can also be changed using the printer driver, however, the setting will be erased when the printer is turned off. If the setting is changed using this tool, it will be retained even when the printer is turned off. Therefore, if you plan on printing without using the printer driver, use this tool to change this setting.

8 Print Density

Adjust the printer's printing density.

Available settings: -5–+5

9 Align Paper Leading Edge when the Cover is Closed

Select whether or not the paper is automatically fed when the cover is closed.

Available settings: **[Feed]**, **[Do not Feed]**

10 Printing Reference Point Adjustment

Adjust the position of the reference point (point of origin for printing). This corrects printing misalignments resulting from differences in printer models or from the fixed margins of some applications.

The reference point cannot be adjusted for raster printing.

11 Tear Adjust

Adjust the tear bar tear off position for paper media.

Available settings: -0.39" to 0.39" (-10.0 mm to 10.0 mm)

Advanced Tab

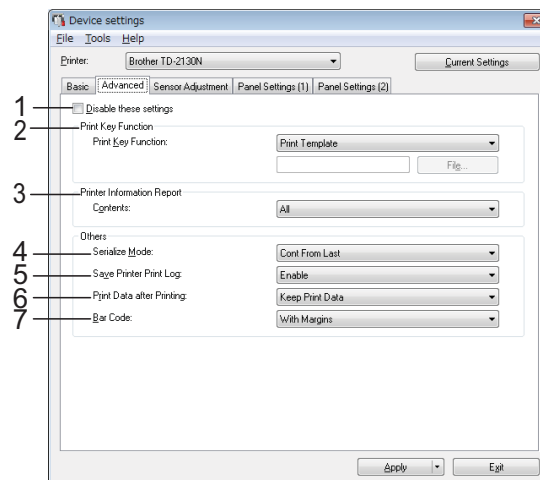

1 Disable these settings

When this check box is clicked,  appears in the tab, and the settings can no longer be specified or changed.

The settings in a tab where  appears will not be applied to the printer even if **[Apply]** is clicked. In addition, the settings in the tab will not be saved or exported when the **[Save in Command File]** or **[Export]** command is executed.

To apply the settings to the printer or save or export them, be sure to clear the check box.

2 Print Key Function

Select the operation that is performed when the  (Print) button is pressed.

If **[Program Settings]** is selected, click the **[File]** button and select the command file.

Available settings: **[Print Template]**, **[Printer Information Report]**, **[Disable Key]**, **[Program Settings]**

3 Printer Information Report

Select which sections are printed when printing the printer setup information.

Available settings: **[All]**, **[Usage Log]**, **[Printer Settings]**, **[Printer Transfer Data]**

(See *Printing the Printer Setup Information* on page 11)

4 Serialize Mode

Select whether or not to serialize from the last number printed.

Available settings: **[Cont From Last]**, **[From Starting#]**

5 Save Printer Print Log

Select whether or not to save the printer's print log. If **[Disable]** is selected, **[Tools]** - **[Save Print Log in File]** cannot be performed.

Available settings: **[Enable]**, **[Disable]**

6 Print Data after Printing

Select whether or not print data is erased automatically after it is printed.

Available settings: **[Erase All Print Data]**, **[Keep Print Data]**

7 Bar Code*

Select whether or not margins are added around barcodes.

Available settings: **[With Margins]**, **[No Margins]**

* If this parameter does not appear in the tab, update the printer driver to the newest version. The newest version can be downloaded from the support website. support.brother.com

Sensor Adjustment Tab

If Media Rolls are being used, it is unnecessary to adjust the sensors.

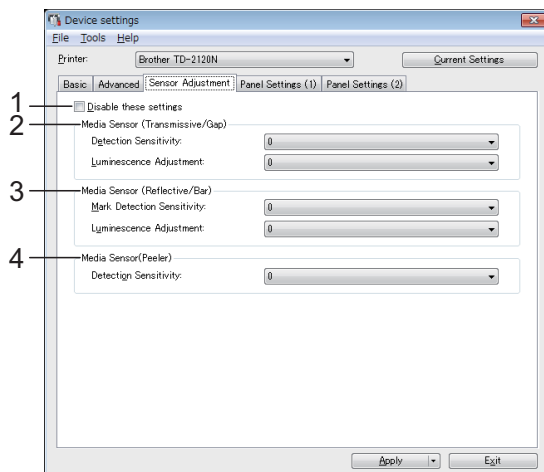

1 Disable these settings

When this check box is clicked,  appears in the tab, and the settings can no longer be specified or changed.

In addition, the settings in a tab where  appears will not be applied to the printer even if **[Apply]** is clicked. To apply the specified or changed settings to the printer, be sure to clear the check box.

2 Media Sensor (Transmissive/Gap)

The following transmissive/gap sensor parameters can be adjusted.

[Detection Sensitivity]

Adjust the precision of the sensor that detects the gaps (spacing) for die-cut labels.

Available settings: -2--+2

[Luminescence Adjustment]

Adjust the amount of light emitted by the transmissive/gap sensor.

Available settings: -2--+2

3 Media Sensor (Reflective/Bar)

The following reflective/black mark sensor parameters can be adjusted.

[Mark Detection Sensitivity]

Adjust the precision of the sensor that detects the black marks.

Available settings: -2--+2

[Luminescence Adjustment]

Adjust the amount of light emitted by the reflective/black mark sensor.

Available settings: -2--+2

4 Media Sensor (Peeler) (TD-2125N/2135N/2125NWB/2135NWB only)

This appears only if TD-2125N/2135N/2125NWB/2135NWB is selected for **[Printer]**. Specify the settings when the label peeler (optional) is used.

Adjust the precision of the sensor that detects whether the label has been peeled.

Available settings: -2--+2

Panel Settings (1)

Specify the settings when the touch panel display (optional) is used (TD-2125N/2135N/2125NWB/2135NWB only).

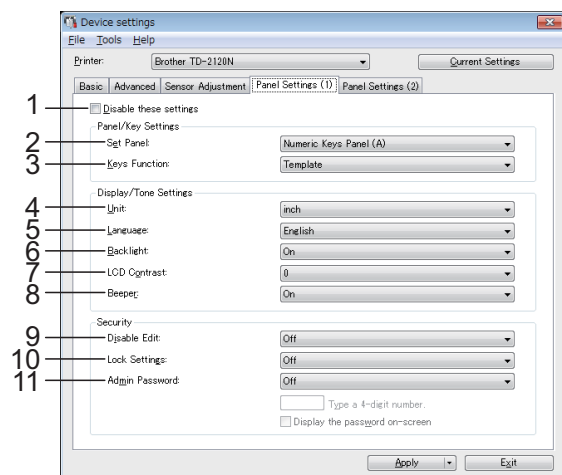

Panel Settings (2)

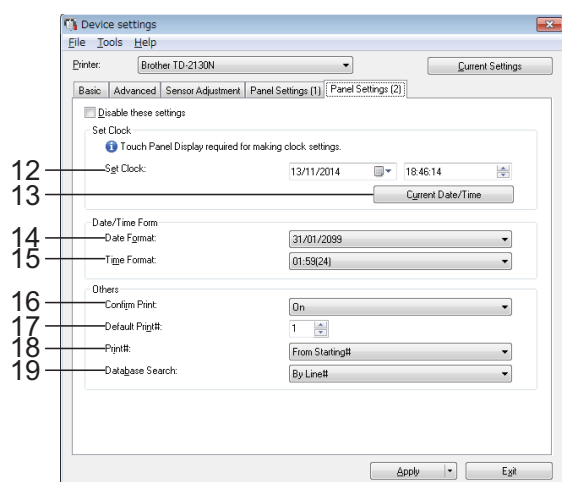

1 Disable these settings

When this check box is clicked,  appears in the tab, and the settings can no longer be specified or changed.

The settings in a tab where  appears will not be applied to the printer even if **[Apply]** is clicked. In addition, the settings in the tab will not be saved or exported when the **[Save in Command File]** or **[Export]** command is executed. To apply the settings to the printer or save or export them, be sure to clear the check box.

2 Set Panel

Select the touch panel to be used.

Available settings: **[Numeric Keys Panel (A)]**, **[One Touch Keys Panel (B)]**

3 Keys Function

Select the type of data assigned to keys in the one-touch panel.

To assign templates, select **[Template]**.

To assign databases linked to a single template, select **[Database]**.

Available settings: **[Template]**, **[Database]**

4 Unit

Select the measurement units for displayed settings.

Available settings: **[mm]**, **[inch]**

5 Language

Select the language of the touch panel display.

Available settings: **[Dansk]**, **[Deutsch]**, **[English]**, **[Español]**, **[Français]**, **[Italiano]**, **[Nederlands]**, **[Norsk]**, **[Português]**, **[Suomi]**, **[Svenska]**, **[日本語]**

NOTE

The possible display languages differ depending on the printer model being used. If the selected language cannot be used for the touch panel display, the display language will not be changed.

Make sure that the touch panel display can display the selected language.

6 Backlight

Select whether the LCD display backlight is turned on.

Available settings: **[On]**, **[Off]**

7 LCD Contrast

Select the LCD display contrast.

Available settings: **-2**–**+2**

8 Beeper

Select whether the printer beeps when a touch panel key is pressed.

Available settings: **[On]**, **[Off]**

9 Disable Edit

Select whether or not label layouts can be edited.

Available settings: **[On]**, **[Off]**

10 Lock Settings

Select whether or not settings selected by pressing [**⚙**] (settings key) on the touch panel display can be changed.

Available settings: [**On**], [**Off**]

11 Admin Password

Set a password for accessing basic settings specified by pressing [**⚙**] (admin key) on the touch panel display. Set a 4-digit password. If the [**Display the password on-screen**] check box is selected, specified passwords will be displayed in computer windows.

12 Set Clock

Set the date and time for the touch panel display.

In order to specify the time settings, the touch panel display must be attached.

13 Current Date/Time

Click to retrieve the current date and time from the computer and display them.

14 Date Format

Select the date format for the clock.

15 Time Format

Select the time format for the clock.

16 Confirm Print

Select whether a message appears before printing so that the number of copies can be confirmed.

Available settings: [**On**], [**Off**]

17 Default Print#

Specify the default number of copies that appears when printing.

Available settings: 1–999

18 Print#*

Select whether or not the number of copies set from the TDU, remains set after the copies are printed.

This TDU setting is applied until the printer is turned off.

Available settings: [**From Starting#**], [**Cont from Last**]

19 Database Search*

When using a template with a linked database, select whether to search for database records by their line number or by their data.

Available settings: [**By Line#**], [**By Data**]

* If this parameter does not appear in the tab, update the printer driver to the newest version. The newest version can be downloaded from the support website.
support.brother.com

Menu Bar

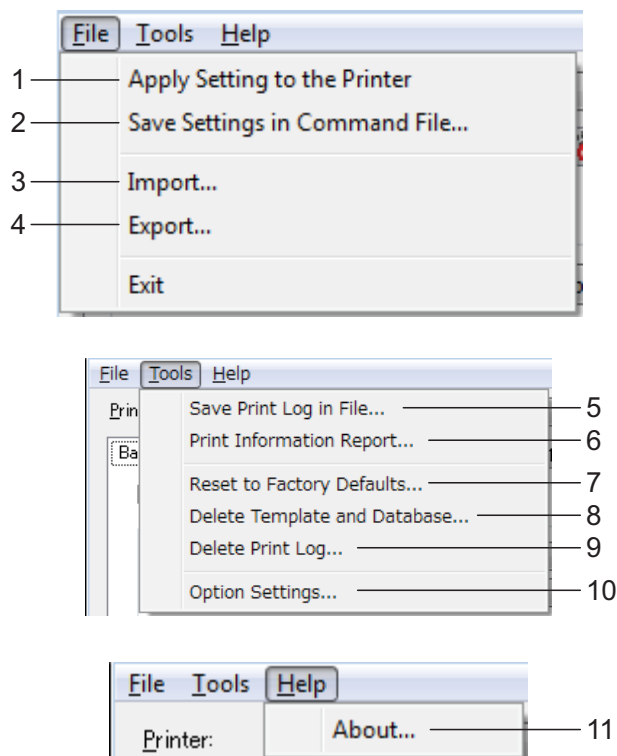

1 Apply Settings to the Printer

Applies the settings to the printer.
Performs the same operation as when the [Apply] button is clicked.

2 Save Settings in Command File

Saves the specified settings in a command file.
Performs the same operation as when [Save in Command File] is selected from the [Apply] drop-down list.

3 Import

Imports the exported file and applies the settings to this tool.

4 Export

Saves the current settings in a file.

5 Save Print Log in File

Saves the print log in a file in the CSV format.
The following information is included in the print log:

- Printing time/date (only when using the touch panel display. The time when printing finished is recorded for the time.)
- Key number*
- Template name*
- Name of database linked to template*

- Number of records in database*
- Number of copies printed
- Error information

* Only when printing templates saved on the printer

NOTE

The print log cannot be saved in a file if [Save Printer Print Log] in the [Advanced] tab has been set to [Disable] and the setting has already been applied to the printer.

6 Print Information Report

The following printer settings will be printed.

- Program version
- Printer usage history
- Missing dot test pattern
- List of transferred data
- Communication settings

NOTE

The printer setup information can also be printed by using the (Print) button. For more information, see *Printing the Printer Setup Information* on page 11.

7 Reset to Factory Defaults

Returns all printer settings, including the communication settings, to their factory defaults. However, templates and databases stored in the printer and the print log are not deleted.

8 Delete Template and Database

Deletes the templates and databases stored in the printer.

9 Delete Print Log

Deletes the print log stored in the printer.

10 Option Settings

If the **[Do not display an error message if the current settings cannot be retrieved at startup.]** check box is selected, a message will not be displayed next time.

11 About

Displays the version information.

P-touch Template Settings

P-touch Template mode provides functions for inserting data from a device, such as a barcode reader connected to the printer, into text and barcode objects in layouts saved on the printer. This is useful for easily printing labels and barcodes.

With **[P-touch Template settings]** in the **“Printer Setting Tool”**, settings for using the P-touch Template functions can be specified or changed.

P-touch Template

The following are the P-touch Template functions.

Basic operations

- Preset template printing

If frequently used label layouts are stored in the printer, labels can be reprinted by simply scanning the barcode for each label layout.

- Barcode printing

A barcode scanned with the barcode reader can be printed with the protocol and size of a previously created template.

- Database-assisted label printing

By linking objects in a label layout to a database, then scanning the key barcodes for the database, labels can be printed with objects in the template replaced with database data.

Advanced operations

- Numbering function (serialized number) printing

Labels can be printed while automatically incrementing a number or barcode in the label.

NOTE

For more information on using the P-touch Template functions, see the Software User's Guide which can be downloaded from our support website. In addition, if command reference is used, see the P-touch Template Command Reference. The latest versions can be downloaded from the support website.

support.brother.com

Select the product, and then select [Manuals].

P-touch Template Settings Dialog Box

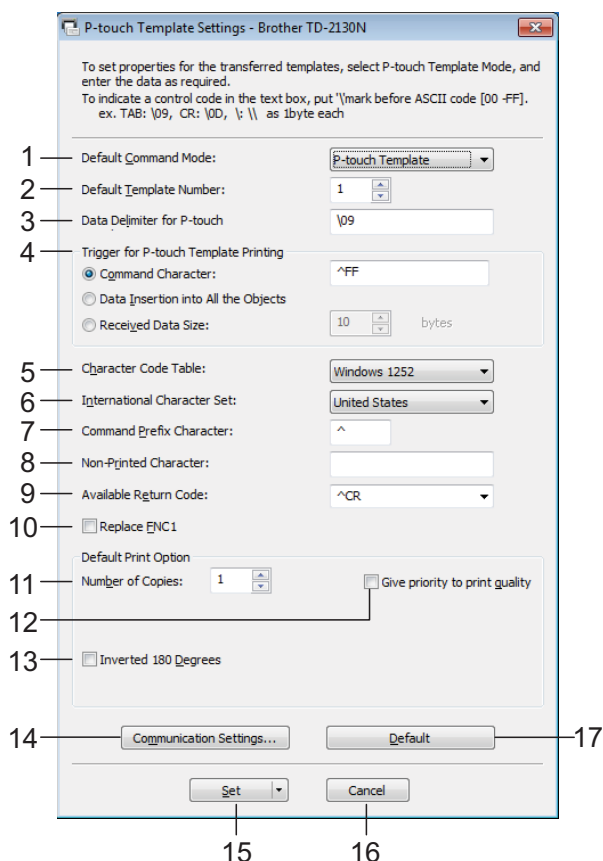

1 Default Command Mode

In order to use P-touch Templates, select the [P-touch Template] mode.

Available settings: [P-touch Template], [ESC/P], [Raster]

2 Default Template Number

Specify the template number selected as the default when the printer is turned on.

However, if any template has been set to not be transferred to the printer, the number of that template cannot be specified.

3 Data Delimiter for P-touch

A delimiter is the symbol used to indicate when to move to the next object in the data that is being sent. Between 1 and 20 characters can be specified.

4 Trigger for P-touch Template Printing

Select one of the following three options for the print start trigger.

[Command Character]: Printing starts when the command character specified here is received.

[Data Insertion into All the Objects]: Printing starts when the delimiter for the last object is received.

[Received Data Size]: Printing starts when the number of characters specified here is received. However, delimiters are not counted in the number of characters.

5 Character Code Table

Select one of the Character code sets.

6 International Character Set

Select one of the following countries for the character set.

Available settings: [United States], [France], [Germany], [Britain], [Denmark I], [Sweden], [Italy], [Spain I], [Japan], [Norway], [Denmark II], [Spain II], [Latin America], [South Korea], [Legal]

The following 12 codes are switched depending on the country selected from those listed above.

23h 24h 40h 5Bh 5Ch 5Dh 5Eh 60h 7Bh 7Ch 7Dh 7Eh

For the characters that are switched, see the P-touch Template Command Reference (which can be downloaded from the Brother support website).

7 Command Prefix Character

Change the prefix character code. Set a single character code.

The prefix character is a code to identify commands used in P-touch Template mode.

8 Non-Printed Character

The characters specified here are not printed when data is received. Specify 1 to 20 characters.

9 Available Return Code

The line feed code is used when feeding data to indicate that the following data should be moved to the next line in a text object. One of the following four line feed codes can be selected, or 1 to 20 characters can be specified as the line feed code.

Available settings: [^CR], [\0D\0A], [\0A], [\0D]

10 Replace FNC1

Select whether or not GS codes, which are included in barcode protocols such as GS1-128 (UCC/EAN-128), are replaced with FNC1 codes.

If this check box is selected, a received GS code is replaced with the FNC1 code. If this check box is cleared, a received GS code is outputted as is.

11 Number of Copies

Set the number of copies. A number between 1 and 99 can be specified.

12 Give priority to print quality

Select the print quality setting. If this check box is selected, priority is given to the print quality.

If this check box is cleared, priority is given to the print speed.

13 Inverted 180 Degrees

If this check box is selected, the data will be printed after it has been rotated 180 degrees.

14 Communication Settings

Sets the following parameters for serial communication:

Baud Rate, Bit Length, Parity and Busy Control.

15 Set

After the [**Set**] button (in the main dialog box or the Communications Settings dialog box) is clicked, the settings are saved as an .ini file when the dialog box is closed.

To save the specified settings in a command file, select [**Save in Command File**] from the drop-down menu. The saved command file can be used with the mass storage feature to apply the settings to a printer. (See *Mass Storage Functions* on page 42)

16 Cancel

Cancels the settings and closes the dialog box. The settings will remain unchanged.

17 Default

Click this button to return the settings (including those in the [**Communication Settings**] dialog box) to their factory defaults.

Paper Size Setup

With **[Paper Size Setup]** in the “**Printer Setting Tool**”, paper sizes not available in the **[Paper Size]** list of the printer driver can be added.

As opposed to specifying paper settings for a normal printer, the paper format must be sent to the printer in order to add the paper size to the printer.

Printing with a paper format not registered with the printer may not provide the intended print results.

Paper Size Setup Dialog Box

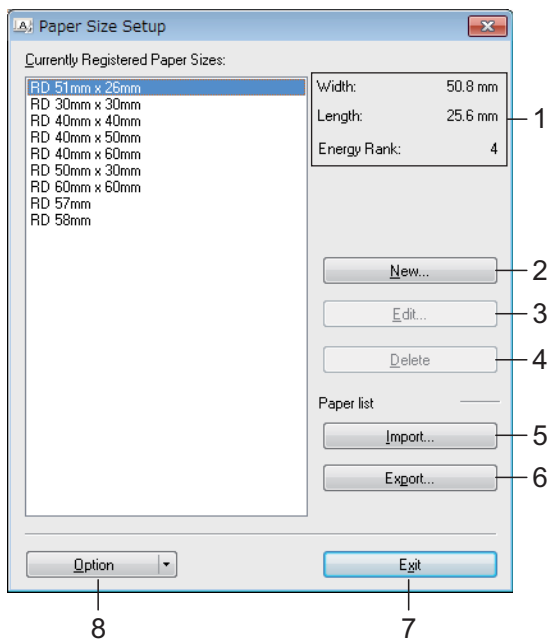

1 Current settings

Displays the current settings for the selected paper format.

2 New

Click this button to display the **[New]** dialog box and register a new paper format. For more information, see *New Dialog Box* on page 39.

Do not register a paper size if the same paper size has already been registered. It may cause an unintended result.



If you wish to use paper of the same size as one that is currently registered, select the desired size from the **[Currently Registered Paper Sizes]** list in the **[Paper Size Setup]** dialog box, and then change the settings from the **[Edit]** dialog box.

3 Edit

Edits the settings for the selected paper format.

To save the selected paper format with the new settings, click **[Overwrite]**. To add a paper format with the new settings, change the name in the **[Paper Size Name]** box, and then click **[Add]**.

Preset Media Roll formats cannot be edited.

4 Delete

Deletes the selected paper format. A deleted paper format cannot be restored.

5 Import

Reads the text file containing the paper format settings, and uses it to replace the contents of the **[Currently Registered Paper Sizes]** list.



When the list is imported, the entire contents of the **[Currently Registered Paper Sizes]** list will be replaced with the imported paper formats.

6 Export

Exports the paper formats in the **[Currently Registered Paper Sizes]** list to a file. The exported formats can then be distributed to other computers. For more information, see *Distributing Paper Formats* on page 41.

7 Exit

Exits **[Paper Size Setup]**, and returns to the main window of the “**Printer Setting Tool**”.

8 Option

Click the ▼ button, and then select an operation.

Click [**Register Paper Size With Printer**] to register the settings for the selected paper format in printer.

Click [**Save in Command File**] to export the paper settings as a command file. (The file extension is “.bin”.)

NOTE

- When the paper format is registered with the printer and [**Exit**] is clicked, the [**Paper Size Setup**] dialog box appears with the added paper size in the [**Currently Registered Paper Sizes**] list. If the application is running, exit the application, restart it in order for the new paper format to appear in the list.
- If the following functions are being used, you can easily apply their settings to the printer.
 - Mass storage feature (page 42)
 - Bluetooth (Object Push Profile (OPP))
 - Wi-Fi® (File Transfer Profile (FTP))



These settings commands are only intended to be used for applying settings to a printer. These commands cannot be imported into [**Paper Size Setup**].

New Dialog Box

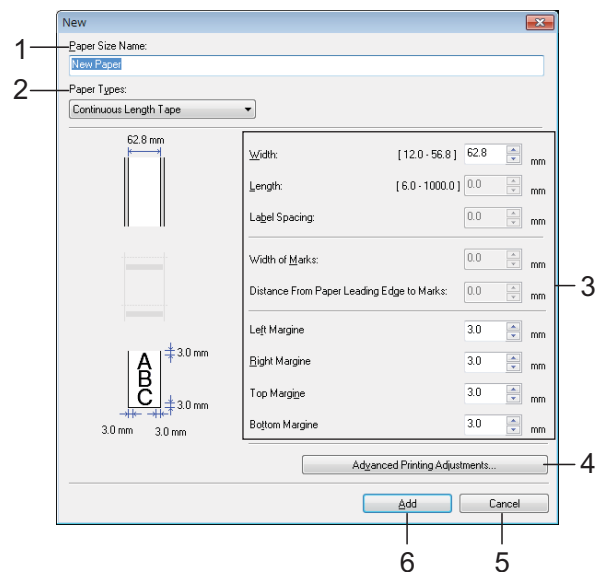

1 Paper Size Name

Type in the name of the paper format to be added.

2 Paper Types

Select the paper type.

Available settings: [**Continuous Length Tape**], [**Media With Marks**], [**Die-cut Label**]

3 Detailed settings

Specify details for the paper format to be added.

4 Advanced Printing Adjustments

Click this button to display the [**Advanced Printing Adjustments**] dialog box and make advanced printing adjustments for each paper format. For more information, see *Advanced Printing Adjustments Dialog Box* on page 40.

5 Cancel

Cancels the settings and closes the dialog box. The settings will remain unchanged.

6 Add

Click this button to add the paper format.

Advanced Printing Adjustments Dialog Box

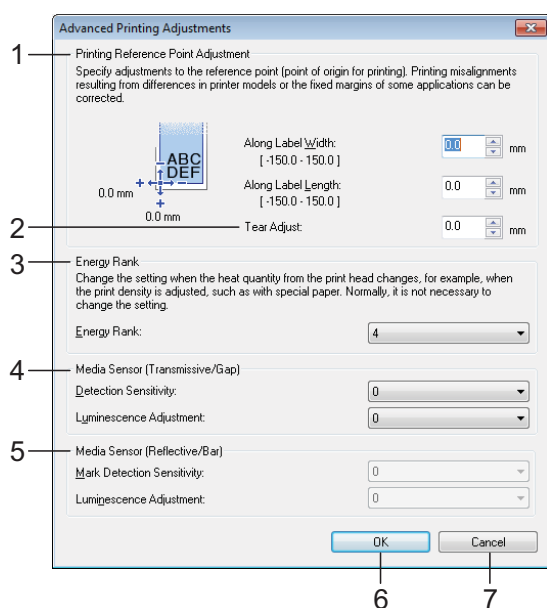

1 Printing Reference Point Adjustment

Adjust the position of the reference point (point of origin for printing). This corrects printing misalignments resulting from differences in printer models or from the fixed margins of some applications.

2 Tear Adjust

Adjust the tear bar tear off position for paper media.

Available settings: -0.39" to 0.39" (-10.0 mm to 10.0 mm)

3 Energy Rank

Select a setting when it is necessary to adjust the amount of heat (energy) from the print head, for example, with special paper.

NOTE

• Advanced Printing Adjustments

When using "Standard Receipt Paper"*, set [Energy Rank] to [6].

* Available paper types vary by country.

- There may be contrast variations in the print result due to the operating environment and media used. Change the setting if necessary.

4 Media Sensor (Transmissive/Gap)

Adjust the precision with which the transmissive/gap sensor detects the gaps (spacing) for die-cut labels and the amount of light emitted by the sensor.

Settings can be specified when [Paper Types] is set to [Die-cut Label].

NOTE

Since the settings for [Media Sensor (Transmissive/Gap)] (page 31) in the [Device settings] dialog box will have an effect, specify appropriate values.

Example of the settings:

	Setting EX1	Setting EX2
Device settings	2	-2
Paper Size Setup	2	2
Actual effect	4	0

5 Media Sensor (Reflective/Bar)

Adjust the precision with which the reflective/black mark sensor detects black marks and the amount of light emitted by the sensor.

Settings can be specified when [Paper Types] is set to [Media With Marks].

NOTE

Since the settings for [Media Sensor (Reflective/Bar)] (page 31) in the [Device settings] dialog box will have an effect, specify appropriate values.

Example of the settings:

	Setting EX1	Setting EX2
Device settings	2	-2
Paper Size Setup	2	2
Actual effect	4	0

6 OK

Saves the settings and returns to the [New] dialog box.

7 Cancel

Cancels the settings and closes the dialog box. The settings will remain unchanged.

Distributing Paper Formats

The paper formats exported from the **[Currently Registered Paper Sizes]** list can be distributed to other computers.

Distributing Paper Formats

If the printer driver has been installed on the recipient's computer, the paper formats need to be distributed.

- 1 At the sender's computer, specify the paper format settings, and then click **[Export]**. (For more information, see *Paper Size Setup* on page 38.)
The following files are created.
TD-2020A:
bst202ed.txt, bst202ed.ptd, pdt3335.bin
TD-2125N:
bst212ned.txt, bst212ned.ptd,
pdt4535.bin
TD-2135N:
bst213ned.txt, bst213ned.ptd,
pdt4735.bin
TD-2125NWB:
bst212nwbed.txt, bst212nwbed.ptd,
pdt4635.bin
TD-2135NWB:
bst213nwbed.txt, bst213nwbed.ptd,
pdt4835.bin
- 2 Save bst202ed.txt, bst212ned.txt, bst213ned.txt, bst212nwbed.txt or bst213nwbed.txt at any location on the recipient's computer.
- 3 At the recipient's computer, click **[Import]**.
The paper formats are replaced with the imported ones.

Mass Storage Functions



Mass Storage Feature

The mass storage feature allows you to execute commands by sending data from a computer or other device to the printer via USB. Files that have been copied to the printer's mass storage area are processed when you press the  (Print) button.

This feature is useful in the following situations.

- When you want templates (.blf format) and settings stored in a command file (.bin format) and distributed by the administrator to be applied to a printer without using a customized tool
- When you want to execute commands without installing the printer driver
- When you want to print and transmit data from a device that has an operating system (including non-Windows operating systems) with a USB host feature

Using the Mass Storage Feature

- 1 Make sure that the printer is turned off.
- 2 Simultaneously press and hold the  (Print) button, press and the  (Power) button.
The printer starts up in mass storage mode, and the POWER indicator lights in orange.

- 3 Connect the computer or device to the printer with a USB cable.
The printer's mass storage area is displayed on the screen of the computer or device.

NOTE

If the mass storage area is not displayed automatically, refer to the instructions for the operating system of the computer or device for information about displaying the mass storage area.

- 4 Drag and drop the file that you want to copy to the mass storage area.
- 5 Press the  (Print) button.
The command file is executed. While the file is being executed, the POWER indicator lights in orange and the STATUS indicator blinks in green.
- 6 After the file has been executed, the STATUS indicator turns off.
- 7 To turn off mass storage mode, turn the printer off.
The printer will start up in its normal operating mode.



- When the printer is turned off, mass storage mode is deactivated and any files in the mass storage area are deleted.
- This feature supports .bin and .bif files. Do not use other file formats with this feature.
- Do not create folders in the mass storage area. If a folder is created, files in the folder will not be executed.
- The capacity of the mass storage area is 16 MB. Use of files larger than 16 MB cannot be guaranteed.
- If multiple files are copied, the order in which the files will be executed cannot be guaranteed.
- Wired or wireless LAN connections, Bluetooth connections or RJ25 to DB9M serial adapter connections are not available while the printer is running in mass storage mode.
- Do not access other files in the mass storage area while a copied file is being executed.

Change Printer Settings Using Web Based Management

You can use a standard web browser to change your printer's settings in Web Based Management using the Hyper Text Transfer Protocol (HTTP) or Hyper Text Transfer Protocol over Secure Socket Layer (HTTPS).

To use Web Based Management, your network must use TCP/IP, and the printer and computer must have valid IP addresses.

Use Web Based Management to manage the following:

- Displaying your printer status information
- Changing network settings, including TCP/IP information
- Displaying the printer's software version information
- Changing network and printer configuration details

NOTE

- We recommend Microsoft Edge for Windows, Google Chrome™ for Android™, and Google Chrome™/Safari for iOS.

Make sure that JavaScript and Cookies are always enabled in whichever browser you use.

- The default login password to manage printer settings is located on your printer and marked "Pwd".

We recommend changing the default password to protect your printer from unauthorized access. For more information, see *Network User's Guide*.

- 1 Start your web browser.
- 2 Type "https://printer's IP address" in your browser's address bar.
For example:
http://192.168.1.2/

NOTE

If you are using a Domain Name System or enable a NetBIOS name, you can type another name, such as “SharedPrinter” instead of the IP address.

For example:
`https://SharedPrinter`

If you enable a NetBIOS name, you can also use the node name.

For example:
`https://brnxxxxxxxxxxxx`

- 3 If required, type the password in the **Login** field, and then click **Login**.
- 4 Change the printer settings as needed.

Every time you access Web Based Management, type the password in the **Login** field, and then click **Login**.

After configuring the settings, click **Logout**.

Software Development Kit

A Software Development Kit (SDK) is available. Visit the Brother Developer Center (<https://support.brother.com/g/s/es/dev/en/index.html?navi=offall>).

You can also download the b-PAC SDK and SDKs for mobile devices (Windows Mobile, Android, iPhone, and iPad). Note that the SDKs that you can download are subject to change without notice.

5

Maintaining the Printer

Maintenance of the printer may be carried out as required. However, some environments require that maintenance must be done more frequently (for example, in dusty conditions). If dirt or dust is not removed, the printed labels may contain white streaks, or media may become jammed.

Print Head Maintenance

Use a dry cotton swab to wipe the print head (1).

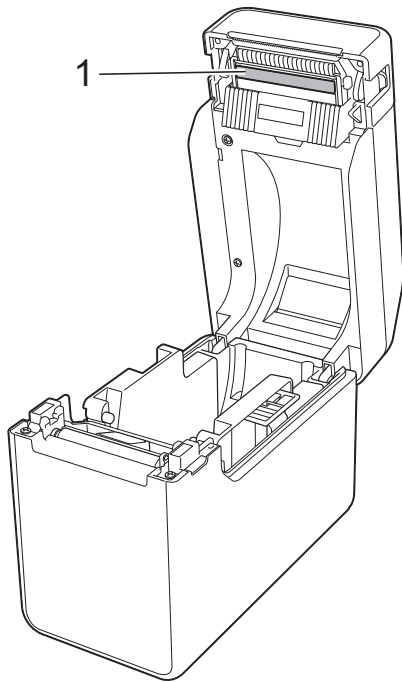

Platen Roller Maintenance

Use a piece of cellophane tape to remove dirt from the platen roller (1).

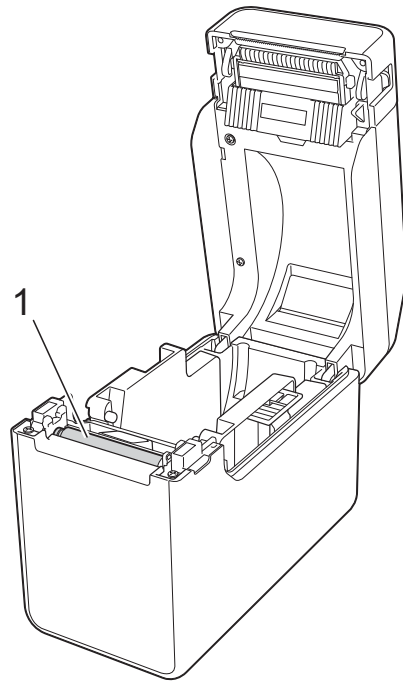

Do not use organic solvents such as benzene.

Media Exit Maintenance

If adhesive accumulates at the media exit (1) and media becomes jammed, disconnect the printer from the AC power outlet, and then clean the media exit with a cloth slightly moistened with isopropyl alcohol.

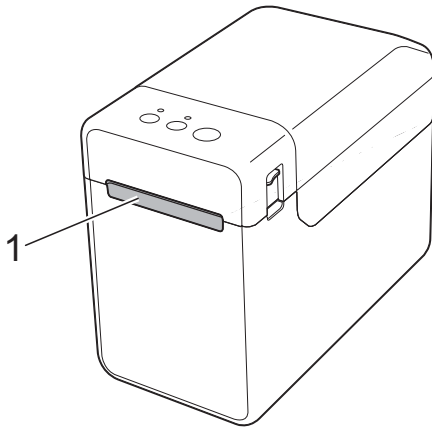

Label Peeler (Optional) Maintenance (TD-2125N/TD-2135N/ TD-2125NWB/ TD-2135NWB only)



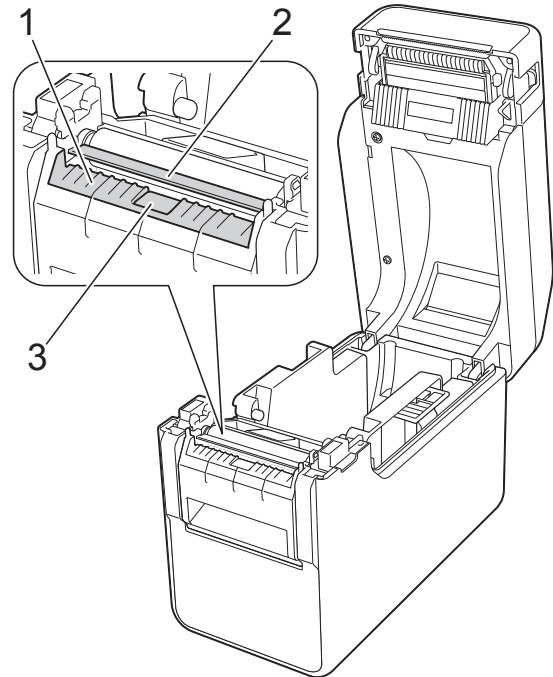









If adhesive accumulates at the media exit (1), peeler separator (2) or peeler sensor (3) and media becomes jammed, disconnect the printer from the AC power outlet, and then clean each part with a cloth slightly moistened with isopropyl alcohol.































LED Indicators

The indicators light and blink to indicate the printer's status. The following symbols are used in this section to show the different indicator colors and patterns.

























For more information on error causes and solutions, see *Troubleshooting* on page 49.

-  or  or  or  Indicators are lit in the color shown
-  or  or  Indicators are blinking in the color shown
-  or  or  Indicators blink one to three times in the color shown, then turn off
-  Indicator is lit or blinking in any color or pattern
-  Indicator is off

POWER	STATUS	Description
		Printer turned on Initializing
		Media Roll Compartment Top Cover open
		Receiving data Transferring/importing data
		Printer cooling off
 (three times)	 (three times)	Resetting the incrementing field
 (one time)	 (one time)	Initialization complete
	 (Once every 1.8 seconds)	Error 1 See <i>Troubleshooting</i> on page 49.
	 (Twice every 1.8 seconds)	Error 2 See <i>Troubleshooting</i> on page 49.
		System error
		Printer in boot mode

POWER	STATUS	Description
 (three times)	 (three times)	Printer resetting
		Printer in mass storage mode
	 (one time)	Processing file in mass storage mode
		<ul style="list-style-type: none"> ■ Setting up WPS ¹ ■ Pairing with Bluetooth

¹ Press and hold the  (Feed) button for 10 seconds to enable a WPS connection.

POWER	STATUS	Wi-Fi	Bluetooth	Description
				Ready to change modes ²
	 (Once every three seconds)	 (Once every three seconds)		Wi-Fi on, not connected
				Wi-Fi on, connected ³
	 (Once every three seconds)		 (Once every three seconds)	Bluetooth on, not connected
				Bluetooth on, connected ³
				Wi-Fi on, connected/Bluetooth, on connected ³

² POWER indicator and STATUS indicator blink in green alternately.

³ Press and hold the  (Feed) button for five seconds to enable or disable Wi-Fi, Bluetooth, or both.

Overview

If you have any problems with the printer, first make sure that you have performed the following tasks correctly:

- Is the appropriate printer driver selected and installed?
See *Installing the Printer Driver and Software* on page 3.
- Is the printer connected to a computer?
See *Connecting the Computer and Printer* on page 13.

If you still have problems, read the troubleshooting tips in this chapter for help.

NOTE

TD-2125N/2135N/2125NWB/2135NWB models:

For more information on the error messages that appear on the touchpanel display (optional), see *Error Messages for Touchpanel Display (Optional) (TD-2125N/TD-2135N/TD-2125NWB/TD-2135NWB Only)* on page 57.









Troubleshooting Tips

Problem	Solution
The POWER indicator is not lit.	<ul style="list-style-type: none"> ■ Is the AC power cord inserted correctly? Check that the AC power cord is inserted correctly. If it is, try plugging it into another AC power outlet. ■ Be sure to use the Brother adapter provided with the printer. ■ If the POWER indicator still does not light up, contact Brother Customer Service.
The indicators show that the printer is in boot mode.	<ul style="list-style-type: none"> ■ The AC Adapter was unplugged while the firmware was being updated, and the printer started up in boot mode when it was turned back on. Contact your reseller or Brother Customer Service for assistance.

Problem	Solution
<p>The indicators show that the printer is cooling down.</p>	<ul style="list-style-type: none"> ■ The print head or motor is too hot. <p>Print head:</p> <p>If the print head becomes too hot, it may produce imaging on the paper in areas not intended to be printed. This condition is normal when printing a large number of documents with a high print density. The printer will stop, and resume printing after the print head has cooled down.</p> <p>To avoid or delay the onset of this condition:</p> <ul style="list-style-type: none"> • Print using a lighter density setting and reduce the number of black areas being printed (for example, remove background shading and colors in graphs and presentation documents). • Make sure that the printer has adequate ventilation and is not located in an enclosed space. <p>Motor:</p> <p>If the printer is used continuously, the motor will become too hot. In this case, the printer will stop and resume printing after the motor has cooled down.</p> <p>NOTE</p> <hr/> <p>This condition may occur more often when the printer is used at a high altitude (above 3,048 m (10,000 feet)) due to the lower air density available to cool the printer.</p> <hr/>
<p>The indicators show that a system error has occurred.</p>	<p>Turn the printer off, and then contact your reseller or Brother Customer Service.</p>
<p>The printer does not print.</p>	<ul style="list-style-type: none"> ■ Is a cable loose? <p>Check that the cables are connected securely.</p> <ul style="list-style-type: none"> ■ Is the STATUS indicator is flashing? <p>An error occurred. Check the descriptions in the <i>LED Indicators</i> on page 47, and then see <i>If the STATUS indicator blinks in red</i> on page 55.</p>

Problem	Solution
<p>Media is not fed correctly.</p>	<ul style="list-style-type: none"> ■ Is the print head or platen roller dirty? Although the print head generally remains clean under normal use, dust or dirt from the platen roller may stick to the print head. If this occurs, clean the print head or platen roller. For more information, see <i>Print Head Maintenance or Platen Roller Maintenance</i> on page 45. ■ Are the sensors in the correct position? Check that the sensors are correctly positioned. For more information, see <i>Checking the Sensor Position</i> on page 9. ■ Has the paper size information been registered with the printer? If the paper size information has not been registered with the printer, the media will not be fed correctly. For more information, see <i>Registering Paper Size Information With the Printer</i> on page 4.
<p>A data transmission error appears on your computer.</p>	<ul style="list-style-type: none"> ■ Is the correct port selected? Check that the correct port is selected. ■ Is the printer in cooling mode (the POWER indicator is flashing in orange)? Wait until the indicator stops flashing, and then try printing again. ■ Is someone printing via the network? If you try to print while other users are printing large amounts of data, the printer will be unable to accept your print job until ongoing printing is finished. In such a situation, execute the print job again after the other jobs are completed.

Problem	Solution
<p>Media is jammed.</p> <p>Media is not ejected correctly after printing.</p>	<ul style="list-style-type: none"> ■ Is there dust or dirt on the print head or platen roller preventing it from turning freely? For more information, see <i>Print Head Maintenance</i> or <i>Platen Roller Maintenance</i> on page 45. ■ Check that the media exit path is not blocked. ■ Is there adhesive on the media exit, or has a media misfeed occurred? For more information, see <i>Media Exit Maintenance</i> on page 46. ■ Remove the Media Roll, and then reinstall it. For more information, see <i>Inserting the Media Roll</i> on page 7. ■ Check that the Media Roll compartment top cover is firmly closed. ■ If the label peeler (optional) is being used, check that the printer driver settings for the peeler function have been specified correctly. For more information, see <i>Printer Driver Settings</i> on page 90.
<p>The print quality is poor.</p> <p>Printed labels contain white streaks.</p>	<ul style="list-style-type: none"> ■ Adjust the printing density. The print density can be specified in the printer driver's dialog box or the "Printer Setting Tool". For more information, see <i>Print Density</i> on page 30. ■ Is there dust or dirt on the print head or platen roller preventing it from turning freely? Clean the print head or platen roller. For more information, see <i>Print Head Maintenance</i> or <i>Platen Roller Maintenance</i> on page 45.
<p>Printed barcodes cannot be read.</p>	<ul style="list-style-type: none"> ■ Print labels so that barcodes are aligned with the print head as shown below. <div data-bbox="858 1480 1230 1666" style="text-align: center;"> <p>The diagram illustrates the correct printing orientation for a barcode. It shows a horizontal print head (labeled 1) positioned above a label. The label has a barcode (labeled 2) that is oriented vertically. A downward-pointing arrow (labeled 3) indicates the direction of printing, showing that the print head is aligned with the vertical barcode.</p> </div> <ul style="list-style-type: none"> 1 Print head 2 Barcode 3 Printing orientation <ul style="list-style-type: none"> ■ We recommend printing the barcodes with [Give priority to quality] selected from the [Quality] options. ■ Try using another scanner.

Problem	Solution
<p>I want to reset the printer.</p> <p>I want to delete the data transferred from the computer.</p>	<p>To reset the printer, perform the following procedure:</p> <ol style="list-style-type: none"> 1 Press and hold the  (Power) button to turn the printer off. 2 Simultaneously, press and hold the  (Feed) button and the  (Power) button until the POWER indicator lights in orange and the STATUS indicator blinks in green. 3 While pressing the  (Power) button, press the  (Feed) button six times. 4 Release the  (Power) button. <p>All of the transferred data from the computer will be deleted, and the printer will be reset to its factory settings.</p>
<p>I want to cancel the current print job.</p>	<p>Make sure that this printer is turned on, and then press the  (Power) button.</p>
<p>I want to reset the incrementing field.</p>	<p>Press and hold the  (Print) button for at least five seconds, until the POWER and STATUS indicators blink in orange three times.</p>
<p>The media cannot be fed to the beginning of a label.</p>	<ul style="list-style-type: none"> ■ If a feed error occurred, use the Custom Label Tool to apply the correct paper settings to the printer. ■ Are the media sensors in the correct position? Check that the sensors are correctly positioned. For more information, see <i>Checking the Sensor Position</i> on page 9.
<p>Data is being sent to the printer, but the POWER indicator is not flashing green.</p>	<p>Make sure that the USB cable is connected securely. Try using another USB cable.</p> <p>(TD-2125NWB/2135NWB only)</p> <p>For WLAN or Bluetooth connection, check that the appropriate LED indicator is lit.</p>
<p>The labels are not peeling correctly (when using the optional Label Peeler).</p>	<ul style="list-style-type: none"> ■ Make sure that the paper is correctly fed through the label peeler. ■ Has the peeler option setting been specified in the printer driver and with the “Printer Setting Tool”? For more information, see <i>Printer Driver Settings</i> on page 90 or <i>Media Sensor (Peeler) (TD-2125N/2135N/2125NWB/2135NWB only)</i> on page 31.
<p>The media is not ejected correctly (when using the optional label peeler).</p>	<p>Has the label peeler sensor been exposed to direct sunlight? If so, loaded media may not be detected correctly. Move the printer in a location not exposed to direct sunlight.</p>

Problem	Solution
The printer does not operate correctly (when using the optional touchpanel).	<ul style="list-style-type: none"> ■ Does the touchpanel name (A or B) printed in the top right corner of the touchpanel match the specified touchpanel name, which appears in the bottom right corner of the LCD? If they do not match, select [Set Panel] on the touchpanel, and then select the correct setting. For more information, see <i>Specifying Settings From the Touchpanel</i> on page 68. ■ Has the type of data assigned to one-touch keys been correctly specified? If the correct setting has not been specified, select [Keys Function] from the touchpanel, and then correctly select [Template] or [Database]. For more information, see <i>Selecting the Data Assigned to Keys on the One-touchpanel</i> on page 78.
No key on the touchpanel was pressed, but data was unintentionally entered (when using the optional touchpanel).	<ul style="list-style-type: none"> ■ Since foreign material, such as dust, caught between the touch panel, protective sheet, and touch panel holder may cause a malfunction. Make sure that no foreign material is attached. ■ Has the touch panel been folded? When a folded touch panel is used, the fold may press on the touch panel holder. Therefore, do not use a touch panel that has been folded.
The data that was entered is different than the data for the touchpanel key that was pressed (when using the optional touch panel display).	<ul style="list-style-type: none"> ■ Foreign matter, such as dust, between the touchpanel, protective sheet, and touchpanel holder may cause a malfunction. Make sure there is no foreign matter on or near the touchpanel. ■ Has the touchpanel been folded? When a folded touchpanel is used, the fold may press on the touchpanel holder. Do not use a folded touchpanel.

If the STATUS indicator blinks in red

If the STATUS indicator is blinking red, complete the following steps to clear the error:

- Press the ⏻ (Power) button once.
- If the error is still not cleared, turn the printer off, and then turn it on again.
- If you still cannot clear the error, contact Brother Customer Service.

Problem	Solution
The STATUS indicator is blinking.	Check the error details in the <i>LED Indicators</i> section on page 47, and then see below.
The indicators show that error 1 has occurred.	<ul style="list-style-type: none"> ■ Is the correct Media Roll installed? Check that the correct media, type (die-cut label or continuous length tape), and die-cut label size are installed. ■ Is the Media Roll installed correctly? If not, remove the Media Roll, and then reinstall it. For more information, see <i>Inserting the Media Roll</i> on page 7. If the label peeler (optional) is being used, see <i>Inserting the Media Roll</i> on page 87. ■ Are the media guides not touching the sides of the Media Roll? Move the media guides against the sides of the Media Roll. For more information, see <i>Inserting the Media Roll</i> on page 7. ■ Is there enough of the roll remaining? If not, install a new Media Roll. ■ Is the Media Roll compartment top cover open? Check that the Media Roll compartment top cover is closed. ■ (TD-2125NWB/2135NWB only) An access point could not be found, or two or more access points have been found after approximately 2 minutes.

Problem	Solution
<p>The indicators show that error 1 has occurred. (continued)</p>	<ul style="list-style-type: none"> ■ If error 1 persists, check for the following: <ul style="list-style-type: none"> - Make sure your media is longer than 39.37" (1 m). - Make sure the file formats are compatible. <p>When sending a template as a BLF file, an error is indicated if the model name in the file is different to the model name of the printer receiving the file.</p> <p>When trying to print a template, an error is displayed if the specified template does not exist.</p> <p>LED indicators shows an error if the search for a template with a linked database fails.</p> <p>LED indicators shows an error if the transferred, data causes the capacity of the user storage area to be exceeded.</p> <p>If you get such errors, turn the printer off, and then turn it on again.</p> <p>If error 1 is not cleared, contact Brother Customer Service.</p>
<p>The indicators show that error 2 has occurred.</p>	<ul style="list-style-type: none"> ■ Is the connected device supported by the USB port? <p>An overcurrent or unsupported device was detected by the USB port. Turn the printer off, and then check the connected device.</p> <p>If a USB hub is connected, the printer will automatically turn off after a certain length of time has passed.</p> ■ Is the printer in mass storage mode? <p>An error is displayed if the file system becomes corrupted or a file is copied while a mass storage file is being processed. Turn the printer off.</p> ■ Has the wireless LAN or Bluetooth connection been interrupted? (TD-2125NWB/2135NWB only). <p>The wireless LAN or Bluetooth connection established while the printer is on was interrupted. Turn the printer off, and then turn it on again.</p>

Error Messages for Touchpanel Display (Optional) (TD-2125N/ TD-2135N/TD-2125NWB/TD-2135NWB Only)

(TD-2125N/2135N/2125NWB/2135NWB only)

If an error message appears on the touchpanel LCD, (optional) check for a solution in the following table.

To clear an error message that appeared, perform the following procedures.

If the STATUS indicator on the printer is blinking red:

Press the ⏻ (Power) button once. If the error is still not cleared, turn the printer off, then on again.

If the STATUS indicator on the printer is not blinking red:

Press any key in the touchpanel once. If the error is still not cleared, turn the printer off, then on again.

If the error message is still displayed, even after performing the procedures described above, contact Brother Customer Service.

Error message	Solution
Check Media!	<ul style="list-style-type: none"> ■ Is the correct Media Roll installed? Check that the correct media, for example, type (die-cut label or continuous length tape) and die-cut label size, is installed. ■ Is the Media Roll installed correctly? If not, remove the Media Roll, and then reinstall it. For more information, see <i>Inserting the Media Roll</i> on page 7. If the label peeler (optional) is being used, see <i>Inserting the Media Roll</i> on page 87. ■ Are the media guides not touching the sides of the Media Roll? Move the media guides against the sides of the Media Roll. For more information, see <i>Inserting the Media Roll</i> on page 7. ■ Is enough of the roll remaining? If not, install a new Media Roll.
Close Cover!	<p>Is the Media Roll compartment top cover open? Check that the Media Roll compartment top cover is closed.</p>
Communication Error!	<ul style="list-style-type: none"> ■ Transfer of the data failed. When sending a template as a BLF file, an error is indicated if the model name in the file is different. ■ Has the wireless LAN or Bluetooth connection been interrupted? The wireless LAN or Bluetooth connection established while the printer is on was interrupted. Turn the printer off, and then turn it on again.
Database Record Problem!	<ul style="list-style-type: none"> ■ There is no database with the specified number. Specify a correct number. ■ An error is indicated if the search of a template with a linked database fails.

Error message	Solution
No Template Selected!	<ul style="list-style-type: none"> ■ There is no template with the specified number. Specify a correct number. ■ When printing a template, an error is indicated if the specified template does not exist.
Setting Wireless LAN Unsuccessful! Try again	<ul style="list-style-type: none"> ■ The access point could not be found. ■ An access point for establishing a connection could not be specified.
Memory Full!	<ul style="list-style-type: none"> ■ Tape exceeding 39.37" (1 m) or incompatible files cannot be printed. ■ An error is indicated if data is transferred, causing the capacity of the user storage area to be exceeded.
Wrong Password!	<ul style="list-style-type: none"> ■ Is the administrator password correct? Type in the correct password. ■ If you do not remember the password, use [Device settings] of the “Printer Setting Tool” to reset the password. For more information, see <i>Admin Password</i> on page 33.
Incorrect Value!	<p>Has a value outside of the allowable range been entered? Type in a value within the allowable range.</p>
Noncompliant USB device. Remove Device!	<p>Has a device been connected that is not supported by the USB host port? An overcurrent was detected by the USB host port, or connection of an unsupported device was detected. Turn off the printer, and then check the connected device.</p>
Mass Storage Operation error!	<p>Is the printer in mass storage mode? An error is indicated if the file system becomes corrupted or a file is copied while a mass storage file is being processed. Turn off the printer.</p>
System Error! 01	If the error message is displayed, contact Brother Customer Service.
System Error! 02	

Product Specifications

Model Name	TD-2020A	TD-2125N	TD-2135N	TD-2125NWB	TD-2135NWB
■ Printing					
Printing Technology	Direct Thermal				
Printing Resolution	203 dpi	203 dpi	300 dpi	203 dpi	300 dpi
Print Speed (Depends on the media used.)	6 ips (152.4 mm/sec)				
Maximum Print Width	2.2" (56 mm)				
Maximum Print Length	39.3" (1,000 mm)				
Minimum Print Length	0.23" (6 mm)				
Printer Control Commands	P-touch Template 2.0, ZPLII compatible, Raster, ESC/P, CPCL compatible				
AC Power Supply	AC Adapter (100 - 240 V 50/60 Hz)				
■ Size					
Weight	2.9 lb (1.32 kg)	3.0 lb (1.34 kg)			
Dimensions (W × D × H)	4.3" × 8.4" × 6.7" (110 mm × 215 mm × 172 mm)				
■ Interface					
USB	USB Ver.2.0 (Full Speed) (mini-B, Peripheral)				
Serial	Original serial cable (Option: PA-SCA-001)				
Wired LAN	Not supported	10/100BASE-TX			
USB Host Port	Not supported	Supported			
Bluetooth	Not supported			Bluetooth Ver.5.2 (Classic + LE) SPP, OPP, HCRP (Bluetooth Classic), GATT (Bluetooth Low Energy) Supported protocol: iAP	
WLAN	Not supported			Wireless LAN (2.4 GHz) IEEE 802.11 b/g/n (Infrastructure Mode) IEEE 802.11 g/n (Wireless Direct Mode) Wireless LAN (5 GHz) IEEE 802.11 a/n (Infrastructure Mode) *Ad-hoc is unsupported	

Model Name	TD-2020A	TD-2125N	TD-2135N	TD-2125NWB	TD-2135NWB
■ Operating Environment					
Windows Operating System	Windows 8.1 / 10 / 11	Win 8.1, 10, 11, Server 2012, 2012 R2, 2016, 2019, 2022			
Operating Temperature	41°F to 104°F (5°C to 40°C)				
Operating Humidity	20% to 80% (No condensation, Maximum wet bulb temperature: 80.6°F (27°C))				
Storage Temperature	-4°F to 140°F (-20°C to 60°C)				
Storage Humidity	20% to 80% (No condensation, Maximum wet bulb temperature: 113°F (45°C))				
■ Media Specifications					
Media Type	Receipt (Non-coated & Coated) Die cut label Tag Wristband				
Thickness (The media material may affect print quality.)	Receipt: 0.0023" to 0.0035" (0.058 mm to 0.090 mm) Label: 0.003" to 0.007" (0.080 mm to 0.170 mm) Tag: 0.0035" to 0.0053" (0.090 mm to 0.0035 mm) Wristband: 0.011" (0.279 mm)				
Outer Diameter	5" (127 mm)				
Core Diameter	1" (25.4 mm)				
Max. Media Width	2.48" (63 mm)				

Product Dimension

NOTE

All measured values are in millimeters.

Front view/Back view

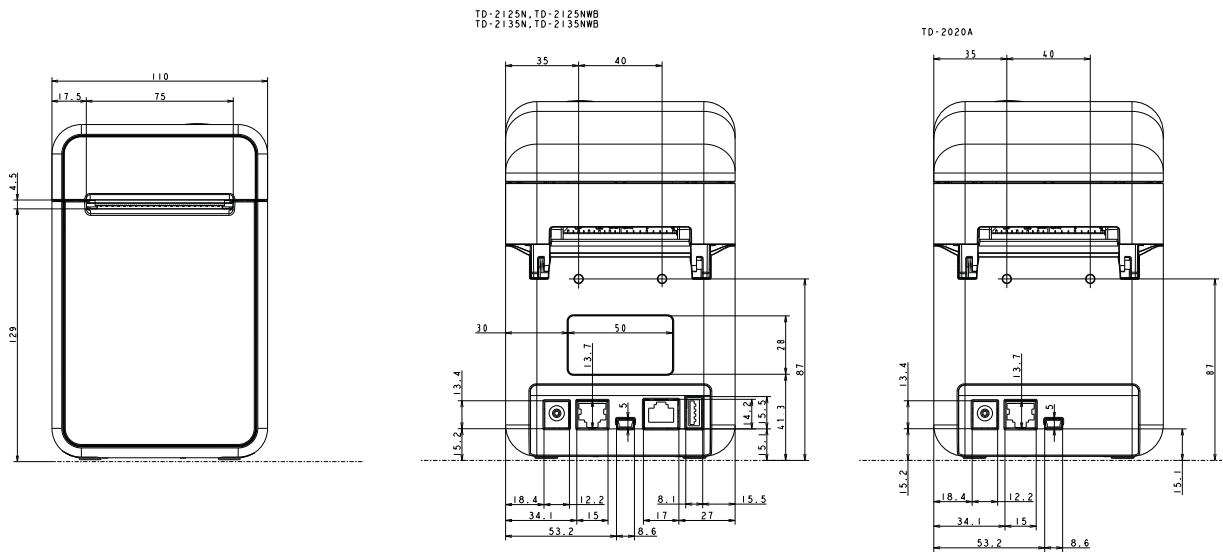

Top view/Bottom view

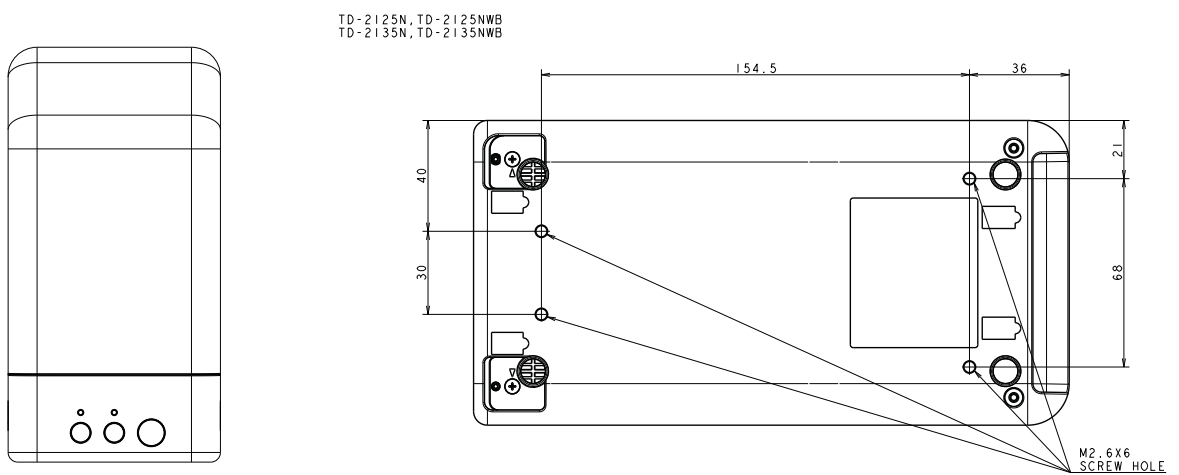

Side view

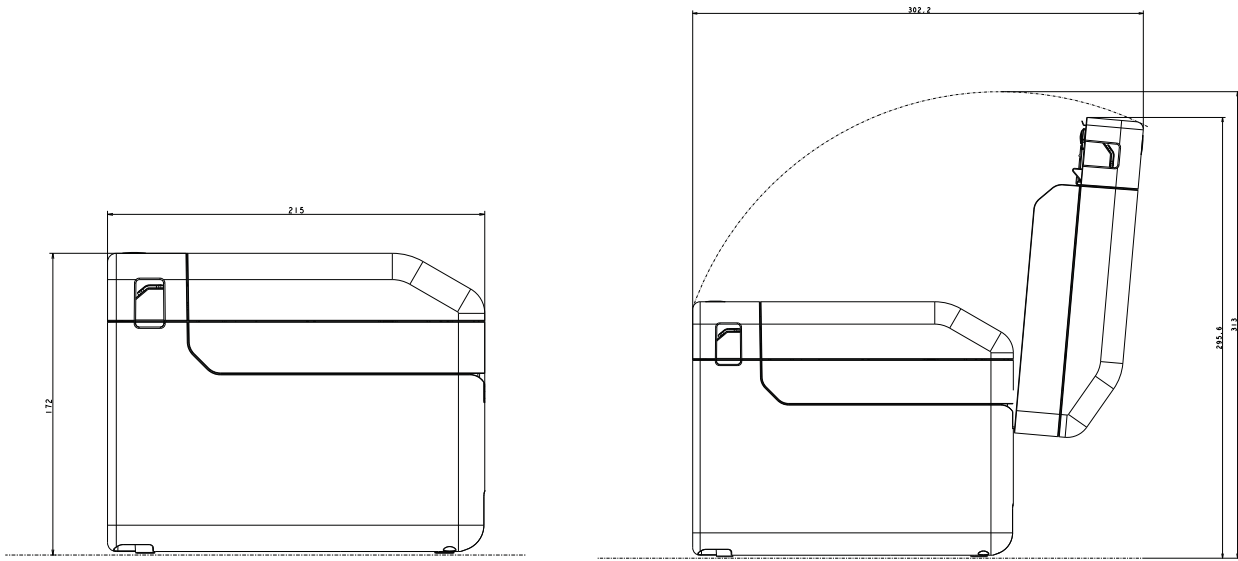

Using the RJ25 to DB9M Serial Adapter (Optional: PA-SCA-001)

Connecting the Computer and Printer With the RJ25 to DB9M Serial Adapter



Be sure to use the cable designed for your Brother optional product.

- 1 Before connecting the serial cable, make sure that the printer and the computer are turned off.
- 2 Connect the RJ25 side of the adapter to the printer.
- 3 Connect the printer end of the serial cable to the DB9M side of this adapter.
- 4 Connect the other end of the serial cable to the serial port on the computer.

NOTE

- The default communication settings are as follows:
 Baud rate: 9600bps
 Parity: None
 Bit length: 8 bits
 Flow control: Hardware
- To change the communication settings, use [P-touch Template settings] in the "Printer Setting Tool" - [Communication settings]. For more information, see the *P-touch Template Command Reference*. The latest versions can be downloaded from the support website.
support.brother.com
 Select the product, and then select [Manuals].

Product Specifications

Converts to a D-sub 9-pin male connector.

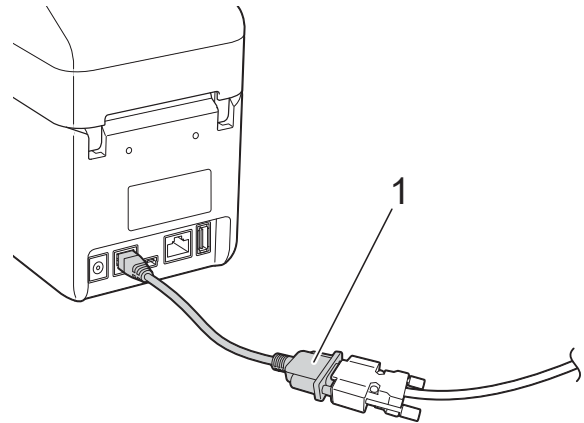

1 RJ25 to DB9M Serial Adapter

10

Using the Touchpanel Display (Optional: PA-TDU-001) (TD-2125N/TD-2135N/ TD-2125NWB/TD-2135NWB only)

The (optional) Touchpanel Display (TDU) is a touchpanel operating unit designed to attach to the printer. Since touchpanel keys can be pressed to perform operations, labels can be printed and various settings can be specified without a computer connection.

For more information on attaching the touchpanel display, refer to the touchpanel's *Quick Setup Guide*.

General Description

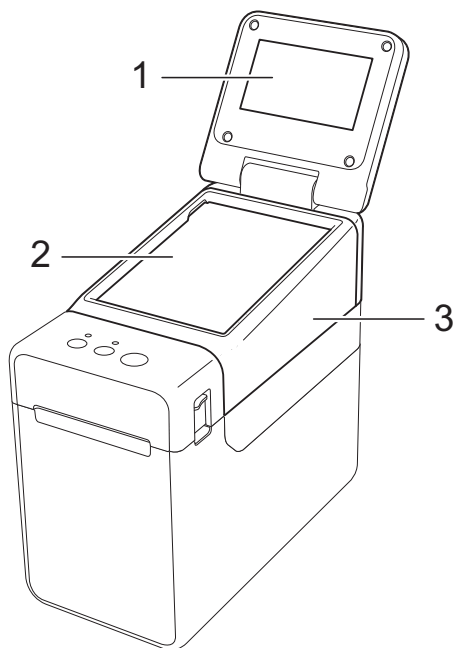

1 LCD

NOTE

A protective clear plastic sticker is placed over the LCD during manufacturing and shipping. This sticker should be removed prior to use.

2 Touchpanel

3 TDU Panel cover

LCD

Lift and adjust the LCD so that the screen is visible. Turn on the backlight if the screen is dark and difficult to read. For more information, see *Specifying Settings From the Touchpanel* on page 68.

Main Screen

When the printer is turned on, the main screen appears.

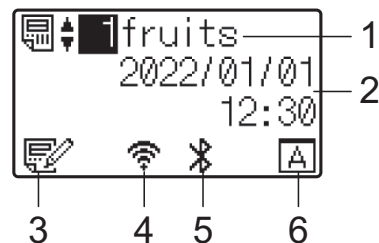



1 Template name and number

2 Time and date

3 Template editing indicator

4 Wireless LAN (Infrastructure mode)

 : Enabled (not connected)

 : Enabled (weak radio wave)

 : Enabled (middle radio wave)

 : Enabled (strong radio wave)

5 Bluetooth

6 Touchpanel setting

 : Basic control panel (A)

 : One-touchpanel (B)

Touchpanel

There are two touchpanels: the basic control panel (A) and the one-touchpanel (B). Either can be selected for use.

Press a key on the touchpanel to perform an operation.

If a label layout has been assigned in advance to a key on the one-touchpanel, a label can easily be printed simply by pressing the key of the corresponding label.

	Do not press on the touchpanel with a sharp object. Otherwise, the touchpanel may be damaged.
---	---

Basic control panel (A)

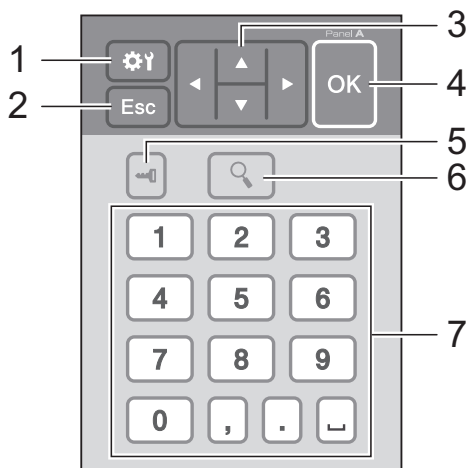

One-touchpanel (B)

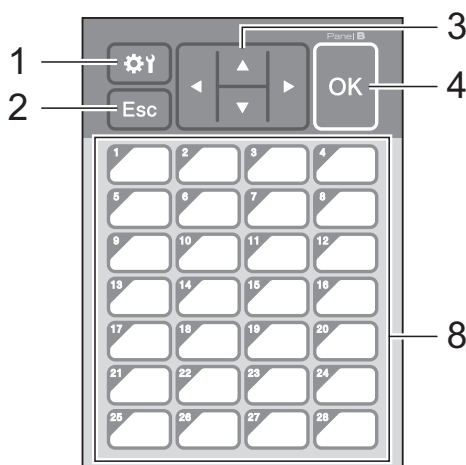

- ⚙️ (Settings key)**
Specify settings for the various parameters.
- Esc (Escape key)**
Tap to the previous operation or press and hold for at least one second to return to the main screen.
- ▲ / ▼ / ◀ / ▶**
Changes what is displayed or increases/decreases values. Holding down this key quickly changes what is displayed or increases/decreases values by 10.
- OK key**
Apply the operation or setting.
- 🔑 (Admin key)**
Specify basic settings for using the touchpanel.
- 🔍 (Search key)**
Press to display the contents of the selected template. You can also check the contents of the database linked to the template.
- Numeric keys**
Type the template number or database record number. These can also be used to edit values in the label layout.
- One-touch keys**
Use to select the label to be printed.

NOTE

The touchpanel name (A or B) is printed in the upper-right corner of the touch panel. Make sure that the specified touchpanel name, which appears in the main screen on the LCD, matches the name of the touchpanel you are using.

Information About Replacing the Touchpanel

- 1 The TDU panel cover is attached with four tabs. While pressing the two tabs (1) at the front, slide the cover up and unhook the tabs. Then, press the two tabs (2) at the back to unhook the tabs in the same way.

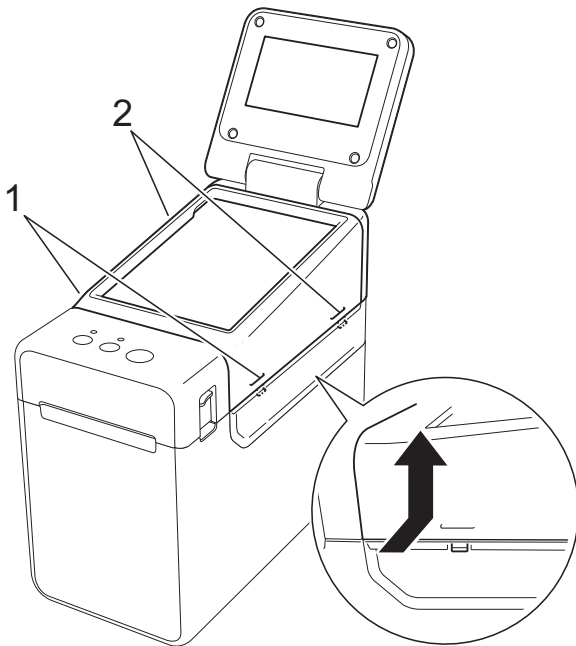

- 2 Remove the TDU panel cover, and place the touchpanel (1) to be used, then the clear protective sheet (2) on the touchpanel holder (3).

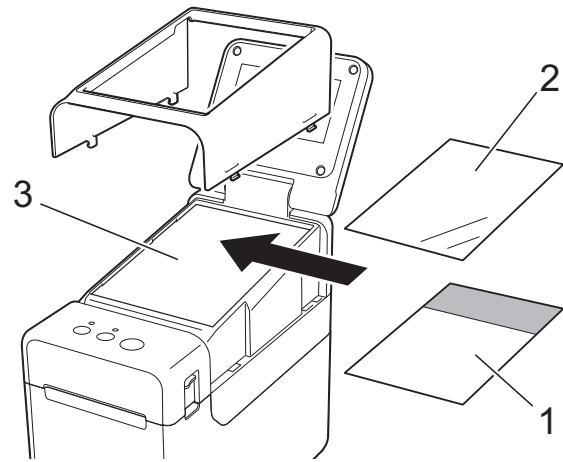

Since foreign material, such as dust, caught between the touchpanel, protective sheet and touchpanel holder may cause a malfunction. Make sure that no foreign material is attached.

- 3 Attach the TDU panel cover in its original position.



When the touchpanel is replaced, the setting for the touchpanel display must be changed. For more information, see *Selecting the Touchpanel* on page 77.

Printing With the Touchpanel Display

Follow the procedure below to print by using the touchpanel display.

1. Preparation

Connect the printer to the computer, and then install the printer driver and software. (page 3)

Install media in the printer. (page 7)

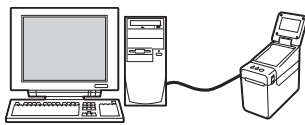

2. Create a label layout.

From the computer, use P-touch Editor, which can be downloaded from our support website, to create a label layout. (page 72)

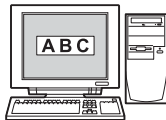

3. Transfer the label layout to the printer.

Use P-touch Transfer Manager to transfer the created label layout from the computer to the printer. (page 76)

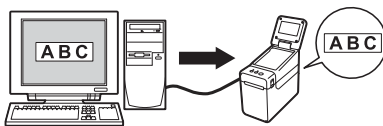

4. Print the label.

Use the touchpanel to print the label. (page 79)



Touchpanel Display Settings

The settings for the touchpanel display can be specified either by using the touchpanel, or by using a tool on a computer connected to the printer. For more information on connecting a computer and specifying settings, see *Device Settings* on page 28.

Specifying Settings From the Touchpanel

Press [⚙] (settings key) or [Admin] (admin key) to display the menu screen. Press [▲] or [▼] to select a parameter, and then press [OK].



- 1 The scroll bar indicates the first parameter with the up arrow, and the last parameter with the down arrow. If the last parameter is selected, pressing [▼] scrolls to the first parameter. If the first parameter is selected, pressing [▲] scrolls to the last parameter.
- 2 The currently selected parameter is highlighted.

With the touchpanel display attached to the printer, the following settings can be specified.

Key	Parameter	Settings	Description
⚙ (settings key)	Print Density	-5/-4/-3/-2/-1/0/+1/+2/ +3/+4/+5	Adjust the printer's printing density.
	Confirm Print	On/Off	Select whether a message appears before printing so that the number of copies can be confirmed.
	Text Direction	Normal/Inverted 180°	Select the printing orientation.
	Exit Position	Tear/Peeler	Select the media exit location.
	Backlight	On/Off	Select whether the LCD backlight is turned on.
	LCD Contrast	+2/+1/0/-1/-2	Select the LCD contrast.
	Beeper	On/Off	Select whether the printer beeps when a touchpanel key is pressed.
	Set Panel	A/B	Select which touchpanel will be used.

Key	Parameter		Settings	Description
☰ (admin key) ¹	Setup	Keys Function	Template/ Database	Select the type of data assigned to keys on the one-touchpanel. To assign templates, select [Template]. To assign databases linked to a single template, select [Database].
		Serialize Mode	Cont From Last/From Starting#	Select whether or not to serialize from the last number printed.
		Default Print#	1-999	Set the default number of copies that appears when printing.
		Set Clock	Default: 2013/01/01 24h 00:00	Set the time and date for the touch panel display.
		Time&Date Form	Date Format: 1/31/2099, 01/31/2099, 31/1/2099, 31/01/2099, 31.1.2099, 31.01.2099, 31-1-2099, 31-01-2099, 2099/1/31, 2099/01/31, 2099-1-31, 2099-01-31	Select the date format for the clock.
			Time Format: 01:59 (24), 1:59 (24), 1:59AM, 01:59AM	Select the time format for the clock.
		☑Language	Dansk/Deutsch/English/Español/Français/Italiano/Nederlands/Norsk/Português/Suomi/Svenska/日本語	Select the language of the touchpanel.
		Unit	inch/mm	Select the measurement units for displayed settings.
		Print# ²	From Starting#/Cont From Last	Select whether or not the number of copies set from the TDU, remains set after the copies are printed. This TDU setting is applied until the printer is turned off.
		Bar Code ²	With Margins/No Margins	Select whether or not margins are added around barcodes.
DB search ²	By Line#/By Data	When using a template with a linked database, select whether to search for database records by their line number or by their data.		

Key	Parameter		Settings	Description
☰ (admin key) ¹ (Continued)	Setup (Continued)	Set Temp Time ²	Default Time/Cont From Last	When directly entering the date/time to be printed, select whether or not the entered date/time remains set after the copies are printed. This setting is applied until the printer is turned off.
		Security	Disable Edit	On/Off
		Lock Settings	On/Off	Allow or disable setting changes for [⚙️] (settings key).
		Admin Password	On/Off	Set password access for [☰] (admin key).
			Enter Password: **** (4 digits)	Type in the 4-digit password.
	Configuration		Printer/ProgVer/ FontVer/Memory	Displays the model name, firmware version, font version and amount of built-in memory.

¹ [☰] (admin key) can be accessed only when touchpanel A (basic control panel) is set.

² This function is available with firmware version 1.04 or later.
The newest version can be downloaded from the support website.
support.brother.com

NOTE

- Some settings may differ depending on the firmware (printer software).
- If you want to reset the settings, use [Device settings] in the “Printer Setting Tool” to return all settings to their factory defaults. For more information, see *Device Settings* on page 28.

Setting the Time and Date

Adjust the clock to the current time and date. This time and date is displayed in the main screen.

- 1 Press [☰] (admin key).
- 2 Press [▼], select [Setup], and then press [OK].
- 3 Press [▼], select [Set Clock], and then press [OK]. The clock setting screen appears.
- 4 Press the number keys to specify the last two digits of the year, two digits for the month and two digits for the day.
For December 1, 2013, press [1] [3] [1] [2] [0] [1].
- 5 Press [▲] or [▼] to select AM, PM or 24, and then press the number keys to specify two digits each for the hour and minutes.
To enter 2:45 in the AM/PM format, press [▼] to select [PM], and then press [▶], then [0] [2] [4] [5].

- 6 Press [OK]. The main screen appears, and the specified time and date are displayed.

NOTE

The format for the time and date can be changed. Press [↵] (admin key), select [Setup], then [Time&Date Form] from the parameters, and then specify settings for [Date Format] and [Time Format].

Setting the Administrator Password

A password can be set so that basic settings specified by pressing [↵] (admin key) cannot easily be accessed. If a password is set, each time [↵] (admin key) is pressed, a password must be entered. Access to these parameters can be restricted by setting a password.

- 1 Press [↵] (admin key).
- 2 Press [▼], select [Admin Password], and then press [OK].
- 3 Press [▼], select [On], and then press [OK].
The password input screen appears.
- 4 Type in the 4-digit password, and then press [OK].
The password is set.

NOTE

- This parameter can be accessed only when touchpanel A (basic control panel) is set.
- After a password has been set, the password input screen appears when [↵] (admin key) is pressed. Type in the specified 4-digit password, and then press [OK].
- To cancel the password settings, press [↵] (admin key), type in the password to display the parameters, and then set [Admin Password] to [Off].
- If you do not remember the password, use [Device settings] in the “Printer Setting Tool” to return all settings to their factory defaults or specify the password again and apply it. For more information, see *Device Settings* on page 28.

Creating a Label Layout

From the computer, use P-touch Editor, which is available downloading from Brother support website, to create a label layout. For more information on use, see the Software User's Guide downloading from Brother support website (support.brother.com).

Creating a Template

■ Label sample



- 1 For Windows 10:
From the Start menu, click [**Brother P-touch**] - [**P-touch Editor**].

For Windows 8.1:

Click [**P-touch Editor**] in the [**Start**] or [**Apps**] screen, or double-click [**P-touch Editor**] on the desktop.

- 2 When P-touch Editor starts, select whether you want to create a new layout or open an existing layout.

- 3 Click [**Paper**] (1), and then specify the media and length (2). (This window appears in [**Express**] mode.)

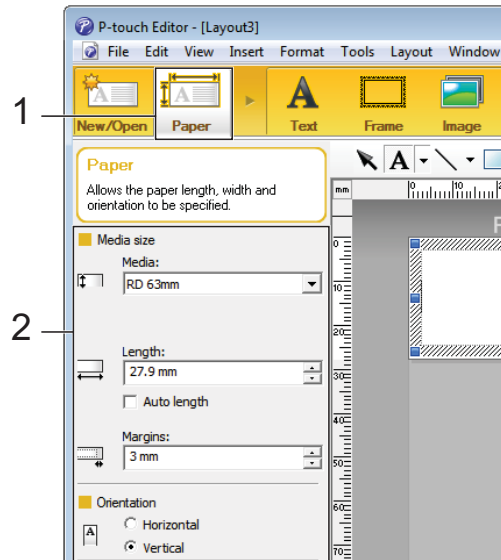

- 4 Click [**Text**] (1), and then specify the font and style (2).

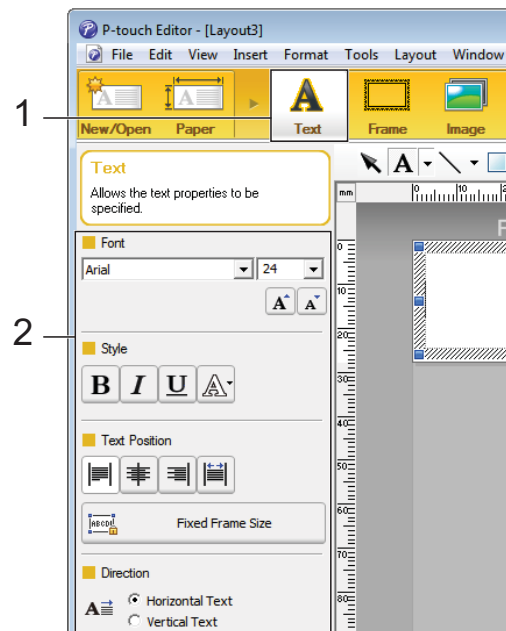

- 5 Clicking **A** displays the cursor so text can be typed in.

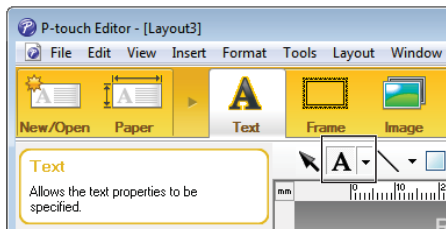

- 6 After inserting the text, click the text box to move it within the template.
- 7 Repeat steps 5 and 6 to enter text and arrange the layout. After entering text, click **[File] - [Save as]** on the menu bar, and then specify the file name for saving the data.

NOTE

The first ten characters of the file name will appear on the LCD as the template name when the touch panel display is used.

Setting the Text and Order for Displaying on the LCD

Using P-touch Editor, the text displayed on the LCD and its display order can be set.

- 1 In P-touch Editor, open the label layout to be edited.
- 2 Select the text box for text to be displayed on the LCD, right-click it, and then click **[Properties]** to display the **[Text Properties]** dialog box. In the **[Object Name]** box on the **[Expanded]** tab, set the desired number (for example, "Text1", "Text2" or "Text3"). The text will be displayed on the LCD in the order of the set numbers. To set that text not be displayed on the LCD, select the **[Text Cannot Be Edited]** check box on the **[Expanded]** tab.

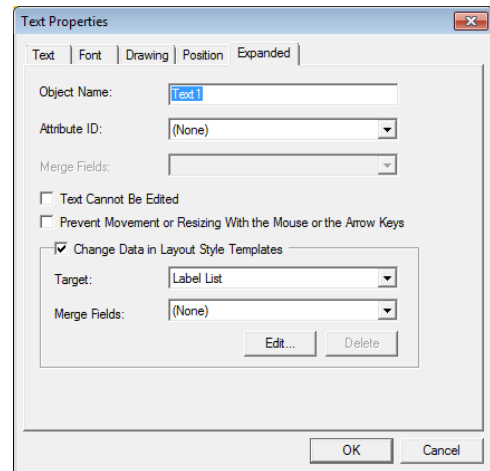

Inserting the Date and Time in a Label

- 1 In P-touch Editor, open the label layout to be edited.
- 2 On the menu bar, click **[Insert] - [Date/Time]** to display the **[Date and Time Properties]** dialog box. Select settings for the format of the text to be inserted.

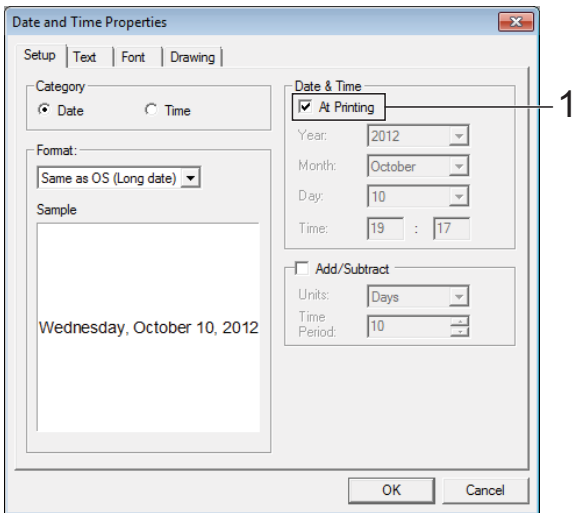

!

- If the **[At Printing]** check box (1) is selected, the date and time of printing will be inserted. If the check box is cleared, the current date and time will be inserted and will not be updated.
- The date and time inserted into the label will be printed in the printer's built-in character size. Since the character size is determined by the size of the date and time object, adjust the object to the desired size in P-touch Editor before transferring the label layout to the printer.

Linking a Database to a Template

- Label sample

Strawberry	Orange	Apple
\$ 2.85	\$ 1.55	\$ 2.15

A database can be linked to the template that was created. Since the text in the template can be replaced with text from the database, multiple labels can be printed simply by creating a single template.

For more information on specifying database settings, see **[P-touch Editor Help]**.

- 1 Prepare a database file in advance.

NOTE

- Files saved as XLS, MDB, CSV and TXT formats can be used as databases.
- Only one database can be linked to a single template. A maximum of 65,000 records can be created in that database. (The total size of templates and databases is limited to 20 MB.)
- The data entered in the database can be displayed on the LCD. Only the first 13 characters can be displayed.

- 2 In P-touch Editor, open the template to be linked to the database.

- On the menu bar, click **[File]** - **[Database]** - **[Connect]** to display the **[Open Database]** dialog box. Select **[Connect Database File]**, click **[Browse]**, and then select the database to be linked.

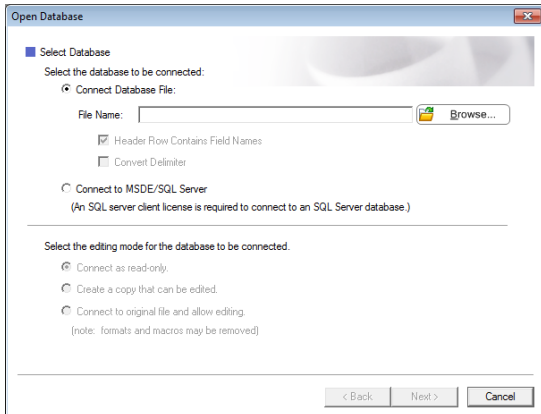

- The template and database will link, and the main window appears. Click the database row to be checked in order to display the label with the text replaced.

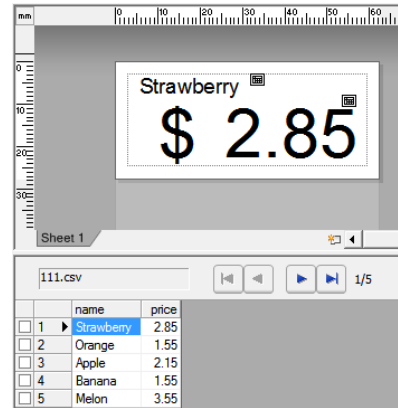

- Click **[Next]** to display a settings dialog box. With **[Database Field]** under **[Merge Fields]**, specify which database column will be linked to which object, and then click **[OK]**.

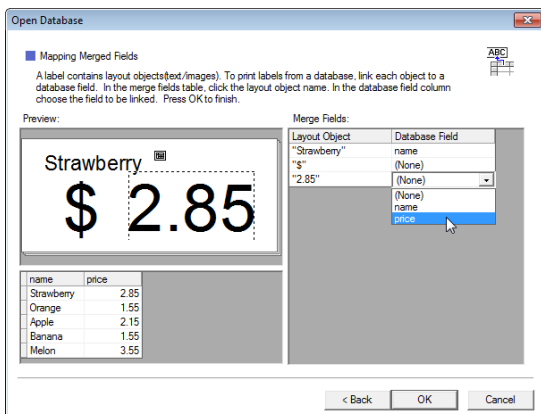

Transferring the Label Layout to the Printer

By transferring the created label layout from a computer to the printer, you can easily use the touchpanel display to print as many labels as required.

Use P-touch Transfer Manager to transfer data. For more information, see the Software User's Guide downloading from Brother support website (support.brother.com).



Before transferring data, make sure that the main screen appears on the LCD.

- 1 Connect the printer to the computer with a USB cable, and then turn on the printer.
- 2 In P-touch Editor, open the label layout to be transferred, and then click **[File]** - **[Transfer Template]** - **[Transfer]**.

NOTE

- If **[Transfer Template]** cannot be selected in P-touch Editor, make sure that the layout window in P-touch Editor is the active window.
- If the label layout has already been transferred to P-touch Transfer Manager, you can start the application.
 - For Windows 10:

From the Start menu, click **[All Programs]** - **[Brother P-touch]** - **[P-touch Tools]** - **[P-touch Transfer Manager]**.

P-touch Transfer Manager starts up.
 - For Windows 8.1:

Click **[P-touch Transfer Manager]** in the **[Start]** or **[Apps]** screen.

P-touch Transfer Manager starts up.

- 3 Select this printer from the **[Printer]** list. Right-click **[Configurations]**, click **[New]**, and then create a new folder with the desired name. (In this example, the folder **[Price Card]** is created.) Click **[Configurations]** or **[All contents]**, and then drag the data to be transferred to the **[Price Card]** folder.

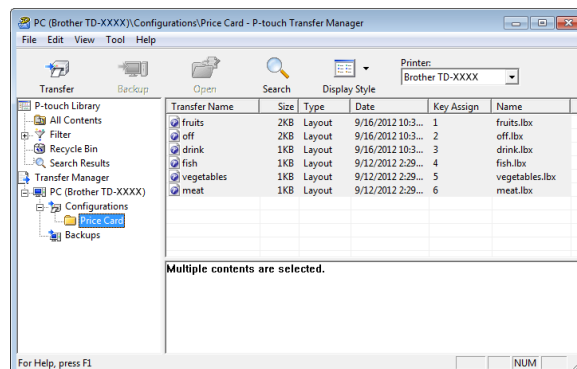

- 4 A key number (number of the template to be registered on the printer) is assigned to the file in the **[Price Card]** folder. To change the number, right-click the file, click **[Key Assign]**, and then select the desired number between 1 and 99.

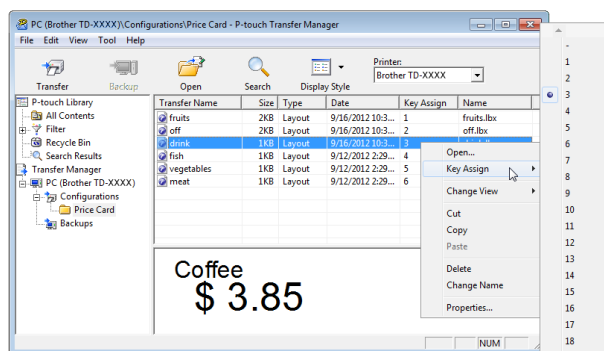

The data registered with keys 1 to 28 (1) of the one-touch panel is determined by the key number.

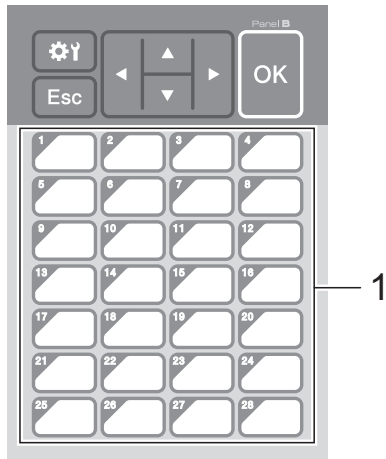

NOTE

- Up to 99 templates can be registered with this printer.
- There are various methods for transferring multiple templates together to the printer, depending on whether the printer driver is installed. For more information, see “Creating Labels” in the Software User’s Guide downloading from Brother support website (support.brother.com).
- If a new template is transferred with the same key number as another template already registered on the printer, the new template will overwrite the old one.

If the one-touch panel will be used, the number must be specified before the data is transferred.

- If templates are assigned to one-touch keys:

Templates with key numbers 1 to 28 are registered with the one-touch key of the same number.

- If databases are assigned to one-touch keys:

When a template with a linked database is selected, databases with numbers 1 to 28 are registered with the one-touch key of the same number.

For more information on specifying the data assigned to one-touch keys, see *Selecting the Data Assigned to Keys on the One-touchpanel* on page 78.

- 5 Select the [**Price Card**] folder, and then click [**Transfer**]. If a confirmation message appears, click [**OK**]. Transferring begins.

Selecting the Touchpanel

Two touchpanels, basic control panel (A) and one-touchpanel (B) can be selected for the touchpanel display.

If the one-touch panel (B) will be used, the data to be assigned to the one-touch panel keys must be specified. For more information on specifying the settings, see *Selecting the Data Assigned to Keys on the One-touchpanel* on page 78.

- 1 Press [**Settings**] (settings key).
- 2 Press [**Down**], select [Set Panel], and then press [**OK**].
- 3 Press [**Up**] or [**Down**], select [A] or [B], and then press [**OK**].
- 4 Follow the on-screen instructions to replace the touchpanel. (For more information on replacing it, see *Information About Replacing the Touchpanel* on page 66.)
- 5 Make sure that the specified touchpanel name shown in the screen matches the name of the touchpanel that is being used, and then press the [Print] button.

Selecting the Data Assigned to Keys on the One-touchpanel

The type of data assigned to one-touch keys when the one-touchpanel is used with the touchpanel display can be specified. The type of data can be either templates or databases.

- Sample label layout registered in the printer:

• Template No.1 (fruits.lbx)

Strawberry

\$ 2.85

Database

No.	Name	Price
1	Strawberry	2.85
2	Orange	1.55
3	Apple	2.15
4	Banana	1.55

• Template No.2 (off.lbx)

Price Down !!

10%OFF

Database

No.	Price
1	10%
2	15%
3	30%
4	50%

• Template No.3 (drink.lbx)

Coffee

\$ 3.85

- If [Template] was set, starting with template number 1, templates are registered with the one-touch key of the same number.

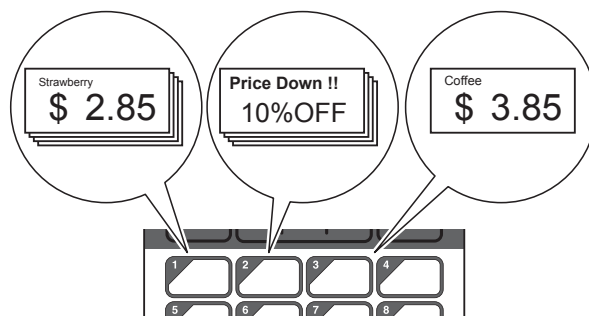

- If [Database] was set, starting with database number 1, the databases of the selected template are registered with the one-touch key of the same number. (The illustration shows when template number 1 is selected.)

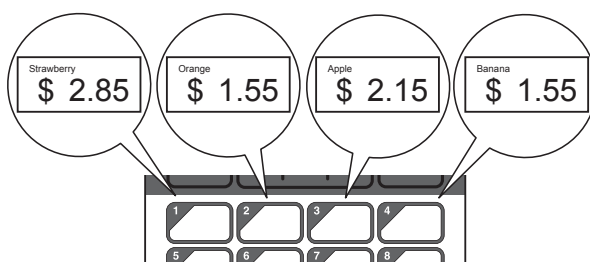

- 1 Press [Admin Key] (admin key).
- 2 Select [Setup], and then press [OK].
- 3 Select [Keys Function], and then press [OK].
- 4 Press [▲] or [▼], select [Template] or [Database], and then press [OK].

Creating a One-touchpanel

A one-touchpanel can be created using any of the following methods.

- Using stickers or in handwriting, note the names of keys directly on the included one-touchpanel.
- The actual panel figure can be found on the last page before the back cover in the Quick Setup Guide for the touchpanel display. This figure can be used by copying it onto plain paper.

Panel size: 5.213" (length) × 3.634" (width) (132.4 mm (length) × 92.3 mm (width))

- A panel format can be downloaded from the following website.

support.brother.com

[**Select your region/country**] - Choose your product - [**Downloads**]

This can be used by typing in the key names, then printing out the data on plain paper.

Printing the Label

A label layout transferred to the printer can easily be printed or edited using the touchpanel display, without a computer connection.

Printing Using the Basic Control Panel

- 1 Turn on the printer. The main screen appears.



- 2 Press [▲] or [▼] to select the number of the template to be printed, or press the number keys to type in the number, and then press [OK]. Press [Q] (search key) to display the template details in the screen.

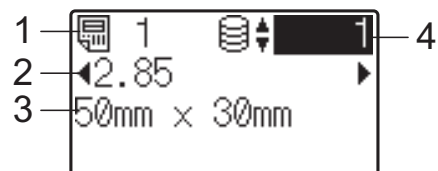



- 1 Template number
- 2 Text in template
- 3 Paper size
- 4 Database record number (only if a database is linked)

NOTE

- All text in the template can be checked by pressing [◀] or [▶].
- The text displayed on the LCD and its display order are set by using P-touch Editor. For more information, see *Setting the Text and Order for Displaying on the LCD* on page 73.

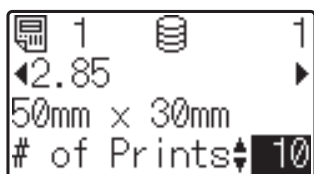
- 3 If a database is linked:
Press [▲] or [▼] to select the number of the database record to be printed, or press the number keys to type in the number, and then press [OK].
- 4 Press the  (Print) button. A message to confirm the number of copies appears.



- 5 Type in the number of copies to be printed, and then press the  (Print) button or [OK]. The labels are printed.

NOTE

- The number of copies to be printed can be set between 1 and 999.
- If the template contains a serialized number, the labels will be printed with the serialized field incremented by the specified number of times.
- If [Confirm Print] is set to [Off], printing begins when the  (Print) button is pressed in step 4.

Editing Label Contents Before Printing

To change the contents of a template that has already been transferred to the printer, the touchpanel can be used to directly edit the data. This saves you the trouble of editing the data from the computer and transferring it to the printer.

NOTE

- Only numbers can be edited.
- Edited template cannot be saved. When a different template or database is selected, the edited data reverts to the original data.



Use the basic control panel to edit data.

- 1 In the main screen, select the template to be edited, and then press [Q] (search key).
If the contents of a database record is to be edited, select the appropriate database record.
- 2 Press [◀] or [▶] to display the item to be edited, and then press [OK].
Editing mode is entered, and the editable number is highlighted.

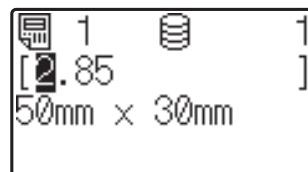

- 3 Press [◀] or [▶] to highlight the number to be edited. Press the number key of the new number to overwrite the old number. (In this example, [2.85] will be changed to [2.45]. Press [▶] to highlight [8], and then press [4] on the number keys.)

 appears in the lower-left corner of the screen to indicate that the template was edited.

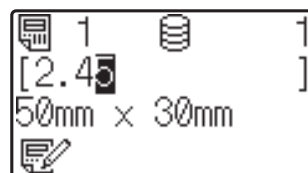

NOTE

- To return the currently displayed item to its original number, press [ESC] to exit the editing mode.
- Holding down [ESC] for at least 1 second returns the currently displayed item to its original number and returns to the main screen. If any other item has been edited,  appears.

- Press [OK] to apply the edited text, and then press the [Print] button. A message to confirm the number of copies appears.

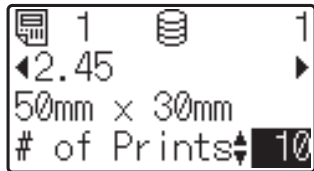

- Type in the number of copies to be printed, and then press the [Print] button or [OK]. The labels are printed.

Searching for Records in a Database Linked to a Template

After a template with a linked database is transferred to the printer, you can search for a record in the database by pressing [Q] (search key) on the basic control panel.

To select whether to search for database records by their line number or by their data, press [Admin] (admin key) on the basic control panel, and then select the desired setting for [DB search].

- **By Line#:** Select this setting to search for database records by their line number.
- **By Data:** Select this setting to search for database records by their data (only numbers up to 13 digits) entered into the first data field (ex: Column A).

NOTE

This function is available with firmware version 1.04 or later.

The newest version can be downloaded from the support website.

support.brother.com

Printing Using the One-touchpanel

If a label layout has been assigned to a key on the one-touchpanel, a label can easily be printed simply by pressing the key of the corresponding label.

!	The data registered with each one-touch key, is determined by the database number or the key number when the data was transferred from the computer to the printer. For more information, see <i>Transferring the Label Layout to the Printer</i> on page 76.
---	---

- Turn on the printer. The main screen appears.



- If databases are assigned to one-touch keys: Press [▲] or [▼] to select a template.
- Press the one-touch key for the label to be printed. The label details appear in the screen.



- Template number
- Text in label layout
- Paper size
- Database record number (only if a database is linked)
- Number of prints

NOTE

- Press [◀] or [▶] to check all of the text in the label layout. If the one-touchpanel (B) is being used, the data cannot be edited. Use the basic control panel (A) to edit the data. For more information, see *Editing Label Contents Before Printing* on page 80.
- The text displayed on the LCD and its display order are set by using P-touch Editor. For more information, see *Setting the Text and Order for Displaying on the LCD* on page 73.

- 4 With [▲] or [▼], type in the number of copies to be printed, and then press the [Print] button or [OK]. The labels are printed.

NOTE

- The number of copies to be printed can be set between 1 and 999.
- If the template contains a serialized number, the labels will be printed with the serialized field incremented by the specified number of times.
- If [Confirm Print] is set to [Off], printing begins when the one-touch key is pressed in step ③.

If a Template With a Linked Database Is Registered with a One-Touch Key

If you register a template with a linked database to a one-touch key, the displayed contents are for the database record corresponding to the number of times that you press the key. For example, with a template that has 3 database records, pressing the one-touch key once will display the contents of the first database record. Pressing it twice displays the contents of the second record, and pressing it three times will display the contents of the third record. Pressing the key four times will return to displaying the contents of the first database record.

- 1 Press the one-touch key for the label to be printed until the contents of the desired database record appears.
- 2 With [▲] or [▼], type in the number of copies to be printed, and then press the [Print] button or [OK]. The labels are printed.

	If a template with a linked database is assigned to a one-touch key, be sure that [Confirm Print] is set to [On]. If [Off] is selected, only the first database can be selected.
---	--

NOTE

- The number of copies to be printed can be set between 1 and 999.
- If the template contains a serialized number, the labels will be printed with the serialized field incremented by the specified number of times.

Printing a Different Date/Time Than the Printer's Internal Clock

The date/time can be temporarily changed before printing. When the following screen is displayed immediately before printing begins, press [Settings] (settings key) to display a screen where the date/time can be directly entered. Printing can be continued after the date/time is entered.



In addition, by pressing [Admin] (admin key), then setting [Set Temp Time] to [Cont From Last], the date/time that was directly entered will be printed until the printer is turned off.

NOTE

- If settings have been specified to add/subtract a period of time to the date/time in a template, the specified time period will be added to (or subtracted from) the directly entered date/time.
- This function is available with firmware version 1.04 or later.

The newest version can be downloaded from the support website.

support.brother.com

Printing Using a Barcode Reader

Using P-touch Template functions, you can scan barcodes to display a template transferred to the printer, replace the text if necessary, then print labels. At this time, the contents of the displayed template or the text to be replaced can be checked on the LCD.

For more information on the P-touch Template functions, see the Software User's Guide downloading from Brother support website (support.brother.com).

To check the text in the template, select the template number in the main screen so that the template details are displayed, and then press [◀] or [▶]. To edit the text, display the text to be edited, and then press [OK]. Editing mode is entered, and the editable text is highlighted.

Since the contents of the label layout can be checked before being printed, you can be sure to avoid printing the wrong label.

Label Layouts on the Printer (Checking, Deleting and Log)

With the following procedures, label layouts on the printer can be checked or deleted, or their print log can be viewed.

Checking the Contents of a Label Layout

To display template details in the screen and check the contents, press [Q] (search key) on the touchpanel. For more information, see *Printing Using the Basic Control Panel* on page 79.

Deleting a Label Layout

[Device settings] of the "Printer Setting Tool" can be used to delete a label layout from the printer. On the menu bar, click [Tools] - [Delete Template and Database] to delete a template or database registered on the printer. For more information, see *Menu Bar* on page 34.

To check the label layouts on the printer and select the data to be deleted, connect the printer to a computer and use P-touch Transfer Manager. For more information, see the Software User's Guide downloading from Brother support website (support.brother.com).

Checking the Print Log for Label Layouts

[Device settings] of the "Printer Setting Tool" can be used to check the print log. If [Save Printer Print Log] on the [Advanced] tab is set to [Enable], a print log will be saved on the printer. To export the print log and save it as a .csv file, click [Tools] - [Save Print Log in File]. For more information, see *Device Settings* on page 28.

Replacing the Time/Date Battery

A time/date battery is provided in order to maintain the settings for the internal clock. The battery will be consumed even if the printer is not used for a long period of time.

- Only use recommended batteries in the printer. Other batteries may cause damage to the printer.
- Dispose of the battery at an appropriate collection point, not in the general waste stream. In addition, be sure to observe all applicable federal, state, and local regulations.
- When storing or discarding the battery, wrap it (for example with cellophane tape), to prevent it from short-circuiting.

(Battery insulation example)

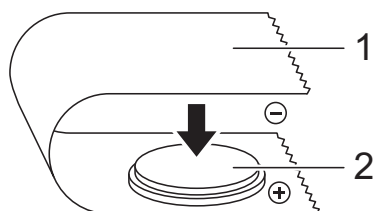

1 Cellophane tape

2 Time/date battery

- We recommend replacing the battery every two years.
- If the clock is reset while power is supplied to the printer, replace this battery. When replacing the lithium battery, purchase a CR2032 battery (recommended manufacturers: Hitachi Maxell, Ltd., FDK Corporation, Panasonic Corporation, Sony Corporation, Toshiba Corporation and VARTA Microbattery Inc.).

- 2 Press the cover release lever on either side and lift to open the Media Roll compartment top cover.
- 3 Using a coin or similar object, slowly turn the time/date battery cover in the direction of the arrow on the battery cover until it stops, and then remove the time/date battery cover.



If the time/date battery cover is forcibly turned past the stop position, it may be damaged.

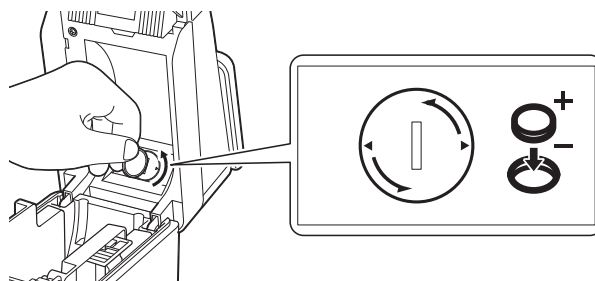

- 4 Remove the battery. As shown below, press part A of the battery to release it so that it can easily be removed.

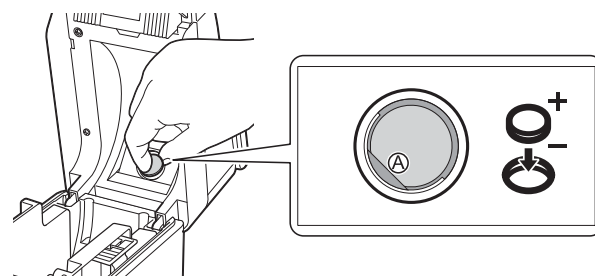

- 5 Insert the new battery.



Be sure to insert the new battery with the + and – sides facing the correct direction.

- 1 Press and hold the  (Power) button to turn the printer off, and then disconnect the printer from the AC power outlet.

- 6 Return the time/date battery cover to its original position, and then use a coin or similar object to slowly turn the time/date battery cover in the opposite direction of the arrow on the battery cover until it stops in order to install the time/date battery cover.

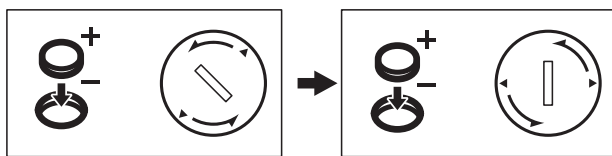
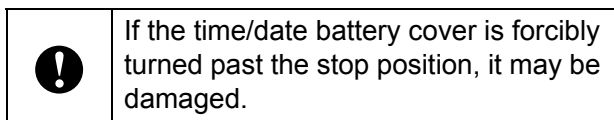

- 7 Close the Media Roll compartment top cover. Press down until it locks into place.

NOTE

The time and date can be configured from the [Admin] (admin key) on the touchpanel. For more information, see *Setting the Time and Date* on page 70.

Frequently Asked Questions

Q. How much memory is available?

A. The printer has 20 MB of built-in memory available, allowing a maximum of 99 templates to be saved. When there is no more of the built-in memory available or when 99 templates have been registered, templates can no longer be transferred to (be registered with) the printer. Delete unnecessary templates from the printer.

Q. Why does the file size change when a template is transferred to the printer?

A. Since the format of a template file added to P-touch Transfer Manager is different from the format of a file after it has been transferred to the printer, the file size changes.

Q. How can I check the number of templates that can be registered on the printer and the key numbers that are being used?

A. Follow the procedure below to check the information:

- 1 Connect the printer to the computer with a USB cable, and then turn on the printer.
- 2 For Windows 10:

From the Start menu, click **[Brother P-touch] - [P-touch Transfer Manager]**.

For Windows 8.1:

Click **[P-touch Transfer Manager]** in the **[Start]** or **[Apps]** screen.

- 3 Click “Brother TD-XXXX” (where “TD-XXXX” is the model name of your printer) in the pane on the left side to display the templates registered with the printer in the pane on the right side. The number of templates and the key numbers that are being used can be checked.

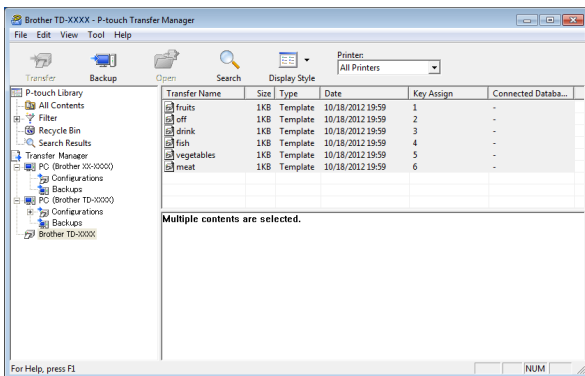

Product Specifications

Size: Approximately 4.37" (W) × 6.70" (D) × 3.07" (H) (111 mm (W) × 170 mm (D) × 78 mm (H))

Weight: 0.76 lb (0.342 kg)

Q. Why can't a template be transferred to the printer (it was transferred, but the date was not automatically updated)?

A. The printer driver may not be correctly installed. Re-install the printer driver, and then try transferring again.

If the date was not updated, check that the [**At Printing**] check box is selected in the [**Date and Time Properties**] dialog box for the template.

For more information, see *Inserting the Date and Time in a Label* on page 74.

11

Using the Label Peeler (Optional: PA-LP-001) (TD-2125N/TD-2135N/ TD-2125NWB/TD-2135NWB only)

Use the (optional) Label Peeler to print labels automatically and peel off the label backing before they are fed out of the media exit slot.

Follow the procedure below to load the correct paper.

For more information on attaching the label peeler (optional), see its instruction manual.



Before using the label peeler, the setting for using the label peeler must be specified in the printer driver. For more information, see *Printer Driver Settings* on page 90.

Inserting the Media Roll

- When using the peeling function of the label peeler to peel off labels while printing:



- We recommend to use genuine Brother roll media.
- Be sure to use die-cut labels. Do not use any other labels.

1

- Press and hold the  (Power) button to turn the printer off. Press the cover release lever (1) on either side and lift to open the Media Roll compartment top cover.

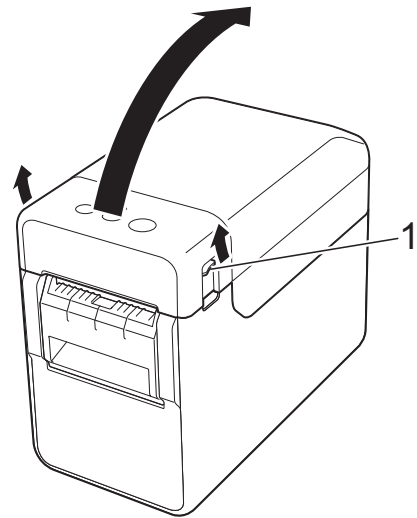

2

- Open the media guides by lifting the media guide adjustment lever (1) and pulling the media guides outwards.

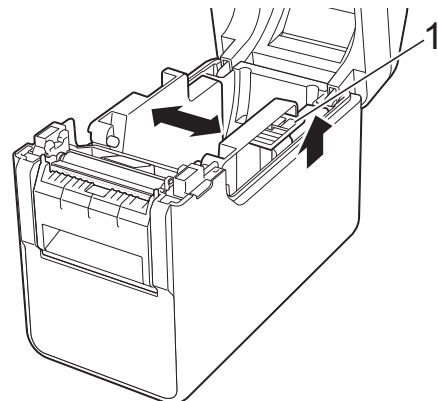

NOTE

The media guides are shipped fully open from the factory.

- 3 Insert the Media Roll so that the labels feed with the side to be printed on facing up (1), as shown.

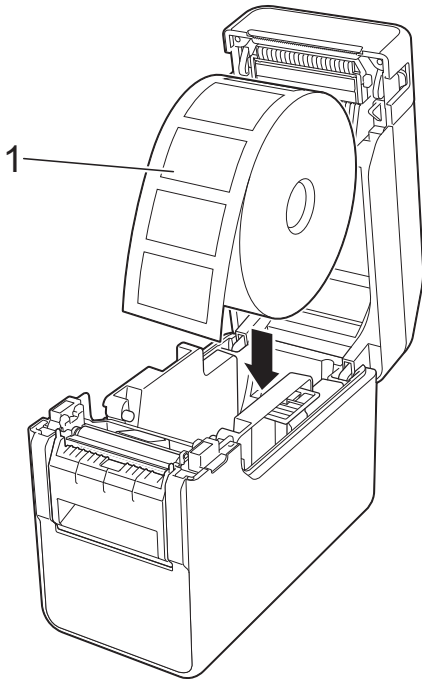

- 4 While lifting the media guide adjustment lever (1), push in both media guides (2) to fit the width of the paper.

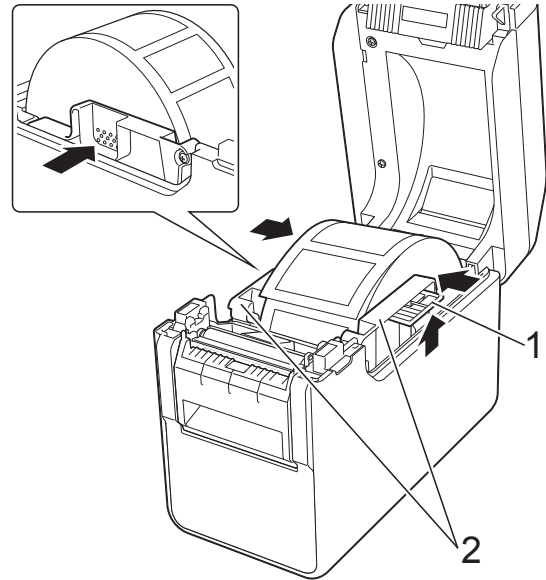

- 5 Feed the end of the Media Roll under the media tip guides (1).

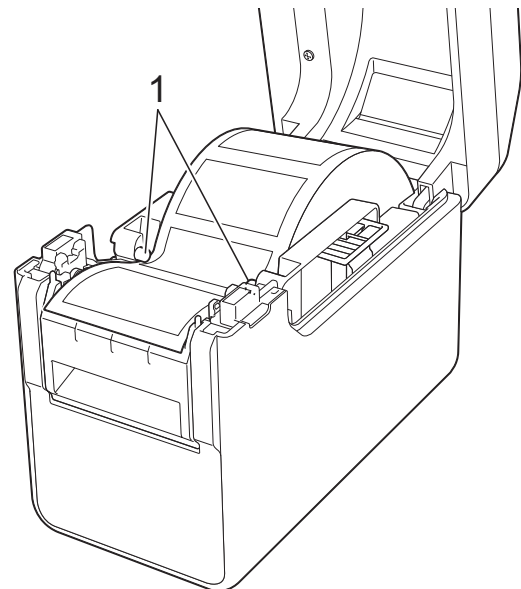

- Use Media Rolls with a maximum outer dimension of 5" (127 mm) or less. Use Media Rolls designed for TD series printers. Regardless of the size, some Media Rolls may not be usable.
- Insert the Media Roll facing the correct direction. If the Media Roll is not inserted correctly, the printer will not print on the correct side of the paper or label.
- When using media with the labels rolled up on the inside, insert the roll in the opposite direction of that shown in step 3 so that the print side of the labels will face up.

- 6** Hold the liner exit of the label peeler and open the peeler door.

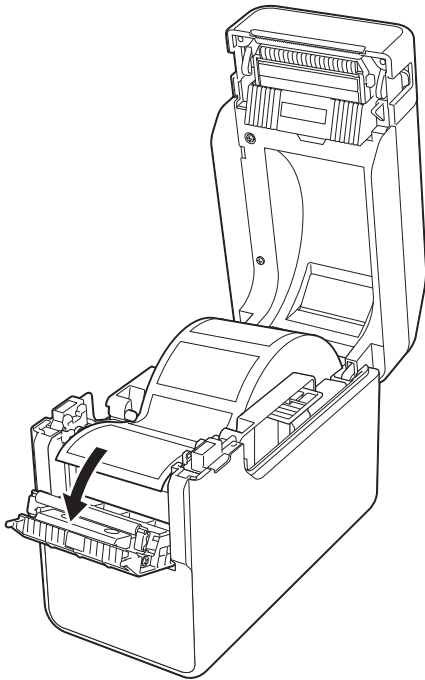

- 8** Close the peeler door.
Close it so that it locks into place.

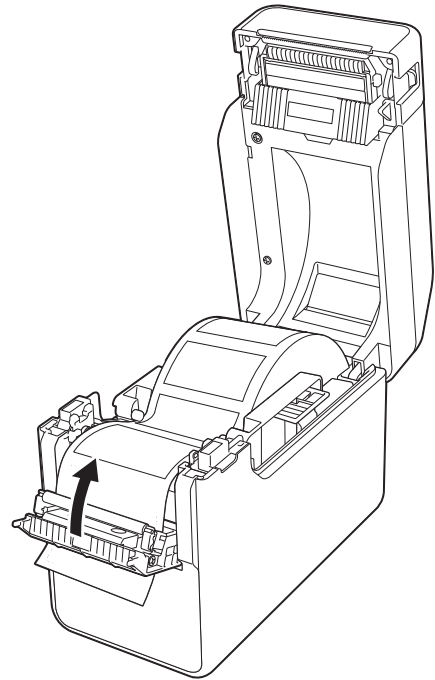

- 7** Peel the backing paper from the label and feed it through the liner exit.

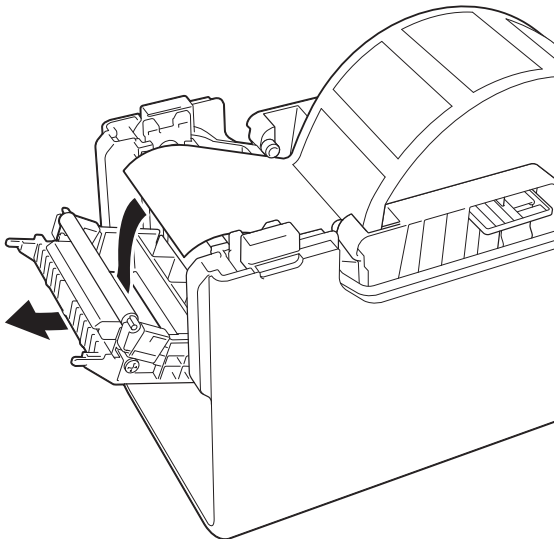

- 9** Close the Media Roll compartment top cover by pressing it in the center.
Press down until it locks into place.

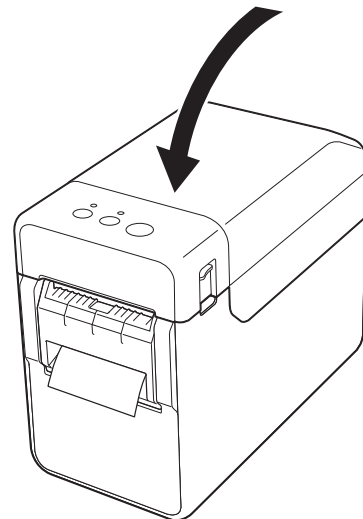

- 10 In order to remove any slack in the roll, lightly pull on the paper fed out of the liner exit until no more can be pulled out.

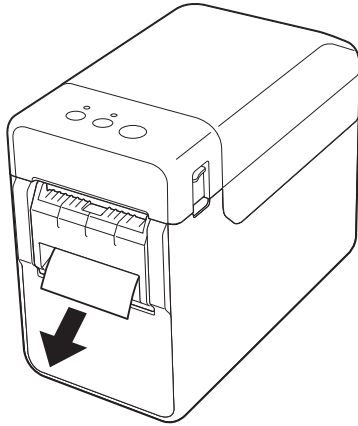

- 11 Press the  (Power) button to turn the printer on.

NOTE

If the paper size information for the die-cut labels being used has been registered with the printer, pressing the  (Feed) button will position the label at the correct starting position. For more information, see *Registering Paper Size Information With the Printer* on page 4.

- When printing without using the peeling function

Receipt paper can be installed normally, and printing can be performed without using the peeling function, even if the label peeler is installed.

For more information on loading paper, see *Inserting the Media Roll* on page 7.

NOTE

When inserting receipt paper, do not feed the paper through the liner exit.

Printer Driver Settings

- 1 Display the printer's **[Printing Preferences]** dialog box.

■ Windows 10

Go to **[Control Panel]**, right-click the printer whose settings are to be changed, and then click **[Printing Preferences]**.

■ Windows 8.1

Click **[Control Panel]** in the **[Apps]** screen - **[Hardware and Sound]** - **[Devices and Printers]**, right-click the printer whose settings are to be changed, and then click **[Printing Preferences]**.

- 2 Select the **[Use Peeler function]** check box on the **[Basic]** tab.

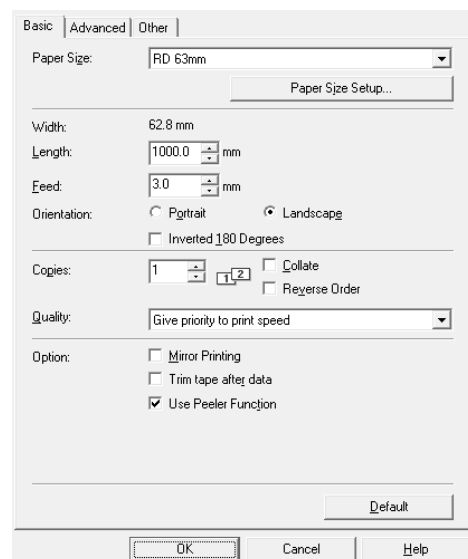

- 3 Click **[OK]** to close the dialog box.

After Printing

Printed labels can be automatically peeled off their backing paper before they are fed out of the media exit. Be sure to remove the printed label. If a label remains in the media exit, the next label will not be printed.

Use scissors to cut off the backing paper that is fed out.

NOTE

With the label peeler, a sensor detects whether or not the label has been peeled off, and controls the appropriate operation. The detection sensitivity of the sensor can be adjusted. For more information, see *Sensor Adjustment Tab* on page 31.

Product Specifications

Size: 4.26" (W) × 5.12" (D) × 1.11" (H)
(108 mm (W) × 130 mm (D) × 28 mm (H))

Weight: 0.14 lb (0.062 kg)

brother