

Support

Support / Support / Soporte / Suporte / Supporto / Поддержка / Wsparcie / Destek / 支援 / 支持 / サポート / 지원

Please visit http://www.gigabyte.com/support-downloads/customer-service to find your BRIX warranty information from the drop down list, or by clicking on the map. You will then be directed to the corresponding page for your region.	
Bitte besuchen Sie http://www.gigabyte.com/support-downloads/customer-service , um Ihre BRIX Garantieinformationen aus der Dropdown-Liste oder durch Klicken auf die Karte zu finden. Sie werden dann auf die entsprechende Seite für Ihre Region weitergeleitet.	Odwiedź stronę http://www.gigabyte.com/support-downloads/customer-service , aby poznać informacje o gwarancji BRIX, wybierając z listy rozwijanej lub klikając mapę. Następnie dojdzie do przekierowania na stronę odpowiednią dla Twojego regionu.
Bitte besuchen Sie http://www.gigabyte.com/support-downloads/customer-service , um Ihre BRIX Garantieinformationen aus der Dropdown-Liste oder durch Klicken auf die Karte zu finden. Sie werden dann auf die entsprechende Seite für Ihre Region weitergeleitet.	Lütfen http://www.gigabyte.com/support-downloads/customer-service sayfasını ziyaret edin ve açılan listeden veya harita üzerine tıklayarak BRIX garantinizi hakkında daha fazla bilgi edinin. Daha sonra bölgenize uygun sayfaya yönlendirileceksiniz.
Veuillez consulter le site http://www.gigabyte.com/support-downloads/customer-service pour trouver les informations relatives à votre garantie BRIX dans la liste déroulante ou en cliquant sur la carte. Vous serez alors dirigé vers la page correspondant à votre région.	請造訪 http://www.gigabyte.com/support-downloads/customer-service ，從下拉式清單中尋找您的 BRIX 保固資訊，或按一下網站地圖。接著網站會將您導引至所在區域的對應頁面。
Visite http://www.gigabyte.com/support-downloads/customer-service para encontrar as suas informações de garantia BRIX a partir da lista suspensa, ou ao clicar no mapa. Será depois direcionado para a página correspondente para a sua região.	请访问 http://www.gigabyte.com/support-downloads/customer-service ，在下拉列表中查找您的 BRIX 保修信息，或者点击地图。网页会跳转到您在地区对应的页面。
Visitate http://www.gigabyte.com/support-downloads/customer-service per informazioni sul vostro BRIX dal menù a scorrimento, o cliccando sulla mappa. Verrete portati sulla pagina corrispondente alla vostra regione.	http://www.gigabyte.com/support-downloads/customer-service を開いてドロップダウンリストから BRIX 保証情報を見つけるか、地図上をクリックしてください。地域の対応するページに誘導されます。
Для получения гарантийной информации об продуктах BRIX посетите сайт http://www.gigabyte.com/support-downloads/customer-service и выберите вашу страну (регион) из выпадающего списка либо на имеющейся карте. Вы будете перенаправлены на страницу вашего региона.	http://www.gigabyte.com/support-downloads/customer-service 의 드롭다운 목록에서 또는 맵을 클릭하여 BRIX 보증 정보를 찾으십시오. 그러면 사용자 지역의 해당 페이지로 이동합니다.
<ul style="list-style-type: none">• For a list of tested memory, M.2 SSD, 2.5" HDD, wireless adapters and OS supported, go to: http://www.gigabyte.com• To download the latest drivers and BIOS updates, go to: http://www.gigabyte.com• For product support, go to: http://www.gigabyte.com	<ul style="list-style-type: none">• Lista przetestowanych pamięci, dysków M.2 SSD, 2.5" HDD, adapterów bezprzewodowych i obsługiwanych systemów operacyjnych znajduje się na stronie: http://www.gigabyte.com• Aby pobrać najnowsze sterowniki i aktualizacje systemu BIOS, przejdź do: http://www.gigabyte.com• Aby uzyskać pomoc techniczną dla produktów należy wejść na stronę: http://www.gigabyte.com
<ul style="list-style-type: none">• Pour obtenir la liste des mémoires testées, des SSD M.2, des disques durs 2.5", des adaptateurs sans fil et des systèmes d'exploitation pris en charge, consultez le site: http://www.gigabyte.com• Pour télécharger les derniers pilotes et les dernières mises à jour du BIOS, rendez-vous à l'adresse suivante: http://www.gigabyte.com• Pour le support produit, consultez le site: http://www.gigabyte.com	<ul style="list-style-type: none">• Test edilmiş hafıza listesi, M.2 SSD, 2.5" HDD, kablosuz adaptörler ve desteklenen OS sürümleri hakkında bilgi almak için: http://www.gigabyte.com sayfasına gidin• En son sürücüler ve BIOS güncellemelerini indirmek için: http://www.gigabyte.com sayfasına gidin• Ürün desteği için: http://www.gigabyte.com sayfasına gidin
<ul style="list-style-type: none">• Para obtener una lista de la memoria probada, SSD M.2, HDD de 2.5", adaptadores inalámbricos y SO compatibles, vaya a: http://www.gigabyte.com• Para descargar los drivers y las actualizaciones de BIOS más recientes, vaya a: http://www.gigabyte.com• Para soporte del producto, vaya a: http://www.gigabyte.com	<ul style="list-style-type: none">• 如需已測試記憶體、M.2 SSD、2.5 吋 HDD、無線介面卡和支援的作業系統清單，請前往： http://www.gigabyte.com• 若要下載最新驅動程式和 BIOS 更新，請前往： http://www.gigabyte.com• 如需產品支援資訊，請前往： http://www.gigabyte.com
<ul style="list-style-type: none">• Para una lista de memoria testada, M.2 SSD, 2.5" HDD, adaptadores sem fios e SO suportado, ir para: http://www.gigabyte.com• Para transferir as drivers mais recentes e atualizações BIOS, ir para: http://www.gigabyte.com• Para suporte de produto, ir para: http://www.gigabyte.com	<ul style="list-style-type: none">• 要获取测试的内存、M.2 SSD、2.5" HDD、无线适配器和支持的 OS 的列表，请访问： http://www.gigabyte.com• 要下载最新的驱动器和 BIOS 更新，请访问： http://www.gigabyte.com• 要获取产品支持，请访问： http://www.gigabyte.com
<ul style="list-style-type: none">• Per una lista di memorie verificate, SSD M.2, HDD 2.5", adattatori senza cavo e sistemi operativi supportati, andate su http://www.gigabyte.com• Per scaricare i driver e i BIOS aggiornati, andate su http://www.gigabyte.com• Per supporto sul prodotto, andate su http://www.gigabyte.com	<ul style="list-style-type: none">• 試驗済みのメモリ、M.2 SSD、2.5" HDD、ワイヤレスアダプタ、対応 OSの一覧はこちら： http://www.gigabyte.com• 最新のドライバと BIOS のアップデートはこちら： http://www.gigabyte.com• 製品サポートはこちら： http://www.gigabyte.com
<ul style="list-style-type: none">• Перечень протестированных модулей памяти, накопителей M.2 SSD, 2.5" HDD, беспроводных адаптеров и поддерживаемых ОС приведен на сайте: http://www.gigabyte.com• Последние версии драйверов и обновлений BIOS можно загрузить на сайте: http://www.gigabyte.com• Для получения технической поддержки посетите сайт: http://www.gigabyte.com	<ul style="list-style-type: none">• 테스트된 메모리, M.2 SSD, 2.5" HDD, 무선 어댑터 및 OS 지원 목록은 다음 사이트를 참조하십시오: http://www.gigabyte.com• 최신 드라이버와 BIOS 업데이트를 다운로드하려면 다음 사이트를 이동하십시오: http://www.gigabyte.com• 제품 지원은 다음 사이트로 이동하십시오: http://www.gigabyte.com

Safety and Regulatory Information

Sicherheit und gesetzliche Bestimmungen / Informations sur la sécurité et la réglementation / Información sobre normativa y de seguridad / Informações de segurança e regulamentares / Informazioni di sicurezza e sui regolamenti / Соответствие требованиям безопасности / Informacje dotyczące bezpieczeństwa i przepisów / Güvenlik ve Düzeneleyici Bilgiler / 安全與規範資訊 / 安全与法规信息 / 安全および規制に関する情報 / 안전 및 규제 정보

This product must be grounded with the plug on the adapter's power cord connected to a power socket with a grounding connection.

Risk of explosion if the battery is replaced with an incorrect type. Batteries should be recycled where possible. Disposal of used Batteries must be in accordance with local environmental regulations.

Es besteht das Risiko einer Explosion, wenn der Akku durch einen nicht geeigneten Typ ersetzt wird. Akkus sollten nach Möglichkeit recycelt werden. Die Entsorgung gebrauchter Akkus muss in Übereinstimmung mit den örtlichen Umweltschriften erfolgen.

Risque d'explosion si la batterie est remplacée par un type incorrect. Dans la mesure du possible, les batteries doivent être recyclées. L'élimination des batteries usagées doit être conforme à la réglementation environnementale locale.

Existe riesgo de explosión si se sustituye la batería por una del tipo incorrecto. Las baterías deben reciclarse siempre que sea posible. La eliminación de las baterías usadas debe realizarse de acuerdo con las normas ambientales locales.

Risco de explosão se a pilha é substituída por um tipo incorreto. As pilhas devem ser recicladas quando possível. A eliminação de pilhas usadas deve ser efetuada conforme os regulamentos ambientais locais.

Sostituire la batteria con una di tipo non corretto può comportare rischio di esplosione. Se possibile, le batterie vanno riciclate. Lo smaltimento delle batterie usate va effettuato secondo le regole ambientali in vigore nella regione in cui ci si trova.

Замена батареи на батарею ненадлежащего типа может привести к взрыву. Использование батарей следует сдавать на переработку при наличии соответствующих возможностей. Утилизация использованных батарей должна осуществляться в соответствии с местными экологическими нормами.

Before you open chassis to exchange an internal component, you need to power off the device and let the device cool down at least 10 minutes.

Vor dem Öffnen des Gehäuses zum Austausch einer internen Komponente müssen Sie das Gerät ausschalten und mindestens 10 Minuten abkühlen lassen.

Avant d'ouvrir le châssis pour remplacer un composant interne, vous devez mettre l'appareil hors tension et le laisser refroidir au moins 10 minutes.

Antes de abrir el chasis para cambiar un componente interno, debe apagar el dispositivo y dejar que se enfrie durante al menos 10 minutos.

Antes de abrir o chasis para alterar um componente interno, tem de desligar o dispositivo e deixar o dispositivo arrefecer, pelo menos, 10 minutos.

Prima di aprire il telaio per cambiare un componente interno, spegnere il dispositivo e lasciarlo raffreddare per almeno 10 minuti.

Перед открытием корпуса для замены внутренних компонентов следует выключить устройство и дать ему остыть в течение 10 минут.

Failure to use the included Model GB-BS Power Adapter may violate regulatory compliance and may expose the user to safety hazards.

Falls das mitgelieferte Netzteil Modell GB-BS nicht verwendet wird, kann dies gegen die gesetzlichen Vorschriften verstoßen und den Benutzer Sicherheitsrisiken aussetzen.

Le fait de ne pas utiliser l'adaptateur d'alimentation modèle GB-BS inclus peut constituer une violation de la conformité réglementaire et peut exposer l'utilisateur à des risques de sécurité.

La no utilización del adaptador de corriente modelo GB-BS incluido puede violar el cumplimiento de la normativa y puede exponer al usuario a riesgos de seguridad.

Não utilizar o adaptador de alimentação modelo GB-BS pode violar a conformidade regulamentar e pode expor o utilizador a perigos de segurança.

Se non si usa l'adattatore per l'alimentazione modello GB-BS compreso nella confezione si rischia di violare il regolamento, e di esporre l'utente a un pericolo per la sua sicurezza.

Неиспользование прилагаемого адаптера питания модели GB-BS является нарушением нормативных требований и может привести к возникновению опасных для пользователя ситуаций.

CAUTION! Hot Surface. Do not touch.

VORSICHT! Heiße Oberfläche. Nicht berühren.

ATTENTION! Surface chaude. Ne pas toucher.

PRECAUCIÓN! Superficie caliente. No tocar.

CAUIDADO! Superficie quente. Não tocar.

ATTENZIONE! Superficie calda. Non toccare.

ОСТОРОЖНО! Горячая поверхность. Не прикасайтесь.

OSTRZEŻENIE! Gorąca powierzchnia. Nie dotykać.

DIKKATI! Sıcak Yüzey. Dokunmayın.

注意! 高温表面。請勿觸碰。

警告! 表面灼热。请勿触摸。

注意! 表面が熱くなっています。触れないでください。

경고! 표면이 뜨겁습니다. 만지지 마십시오.

경고! 표면이 뜨겁습니다. 만지지 마십시오.

At the end of its serviceable life, this product should not be treated as household or general waste. It should be handed over to the applicable collection point for the recycling of electrical and electronic equipment, or returned to the supplier for disposal.

This device complies with Part 15 of the FCC Rules. Operations is subject to the following two conditions: (1) this device may not cause harmful interference, and (2) this device must accept any interference received, including interference that may cause undesired operation.

GIGABYTE™



BRIX PRO Ultra Compact PC Kit

BRIX PRO GB-BS Ultrakompaktes PC Kit / Kit PC ultra compact BRIX PRO GB-BS /

Kit de PC ultra compacto BRIX PRO GB-BS / Kit PC BRIX PRO GB-BS Ultra Compact /

Kit per PC BRIX PRO GB-BS Ultra Compacto / Ультракompактный ПК BRIX PRO GB-BS, базовый комплект /

Zestaw BRIX PRO GB-BS Ultra Compact PC / BRIX PRO GB-BS Ultra Kompakt PC Kiti /

BRIX PRO GB-BS 系列超微型電腦 / BRIX PRO GB-BS 系列超紧凑型 PC 套件 /

BRIX PRO GB-BS 超小型PC套件 / BRIX PRO GB-BS Ultra Compact PC 키트

Quick Start Guide

Kurzanleitung / Guide de démarrage rapide / Guía de inicio rápido /

Guia de inicio rápido / Guida di avvio rapido / Краткое руководство /

Skrócona instrukcja obsługi / Hızlı Başlangıç Kılavuzu /

快速入門使用者手冊 / 快速入門指南 / クイックスタートガイド / 빠른 시작 가이드

Getting Familiar with Your Unit

Erste Schritte mit Ihrem Gerät / Se familiariser avec votre appareil / Familiarizándose con su unidad / Familiarizar-se com a unidade / Imparare a conoscere la propria unità / Знакомство с изделием /

Zapoznanie się z jednostką / Cihazınız Hakkında Bilgi Sahibi Olun / 認識您的裝置 (※系統操作溫度 0°C~35°C) / 了解您的设备 (※系統操作溫度 0°C~35°C) / ユニットの知る / 기기에 대해 알아보기

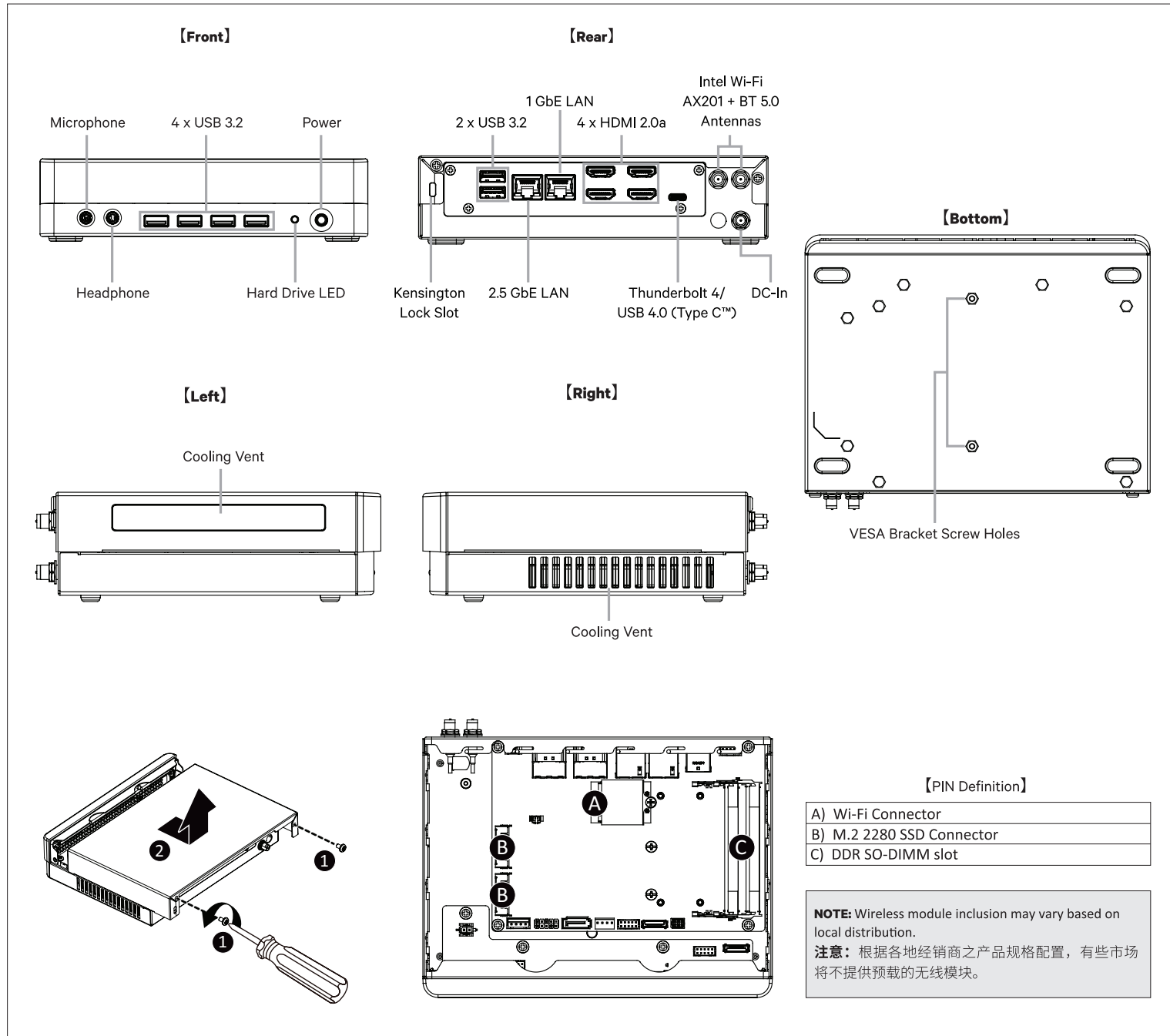

HDMI™
HIGH DEFINITION MULTIMEDIA INTERFACE



25ME0-XTFB00-Q0H
产地: 台湾 Made in Taiwan



At the end of its serviceable life, this product should not be treated as household or general waste. It should be handed over to the applicable collection point for the recycling of electrical and electronic equipment, or returned to the supplier for disposal.



This device complies with Part 15 of the FCC Rules. Operations is subject to the following two conditions: (1) this device may not cause harmful interference, and (2) this device must accept any interference received, including interference that may cause undesired operation.

GIGA-BYTE TECHNOLOGY CO., LTD.

No.6, Bao Chiang Road, Hsin-Tien Dist., New Taipei City 231, Taiwan <http://www.gigabyte.com>

©2015 GIGABYTE Technology Co., Ltd. All rights reserved. The marks mentioned herein are trademarks or registered trademarks of GIGABYTE Technology Co., Ltd. or its affiliates. All other product names mentioned herein are trademarks or registered trademarks or their respective owners.

The terms HDMI and HDMI High-Definition Multimedia Interface, and the HDMI Logo are trademarks or registered trademarks of HDMI Licensing LLC in the United States and other countries.

技嘉科技股份有限公司

新北市新店區寶強路6號

A) Wireless Module: How to Safely Remove the Module

Drahtlosmodul: Sicheres Entfernen des Moduls / Module sans fil : Comment retirer le module en toute sécurité / Módulo inalámbrico: Cómo quitar el módulo de forma segura / Módulo sem fios: Como remover com segurança o módulo / Módulo senza cavi: Come rimuovere il modulo in sicurezza / Беспроводной модуль: Безопасное отсоединение модуля / Moduł bezprzewodowy: Bezpieczne usuwanie modułu / Kablosuz Modül: Modül Güvenli Bir Şekilde nasıl Çıkarılır / 無線模組: 安全移除模組的方式 / 无线模块: 如何安全移除模块 / ワイヤレスモジュール: モジュールの安全な取り外し方法 / 무선 모듈: 모듈을 안전하게 제거하는 방법

1

Disconnect the two antennas by manually lifting off the clips that hold them in place.
向上移除連接於無線模組左側頂端天線。

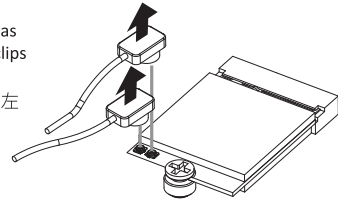

2

Remove the screw in the middle.
鬆開固定於無線模組中央頂端的螺絲。

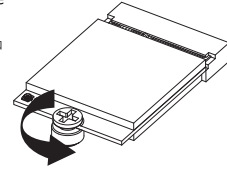

3

Carefully pull the wireless module from the slot.
小心的把無線模組從M.2插槽拔除。

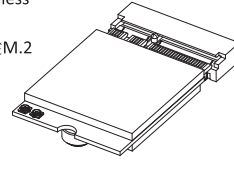

依據低功率電波輻射性電機管理辦法【第十二條】經型式認證合格之低功率射頻電機，非經許可公司、商號或使用者均不得擅自變更頻率、加大功率或變更原設計之特性及功能。【第十四條】低功率射頻電機之使用不得影響飛航安全及干擾合法通信；經發現有干擾現象時，應立即停用，並改善至無干擾時方得繼續使用。前項合法通信指電信法規定作業之無線電通信。低功率射頻電機須忍受合法通信或工業、科學及醫療用電波輻射性電機設備之干擾。」

B) M.2 SSD: How to Install the M.2 2230 SSD

M.2 SSD: Installation der M.2 2230 SSD / SSD M.2 : Comment installer le SSD M.2 2230 / SSD M.2: Como instalar el SSD M.2 2230 / M.2 SSD: Como instalar o M.2 2230 SSD / SSD M.2: Come installare l'SSD M.2 2230 / M.2 SSD: Установка модуля M.2 2230 SSD / M.2 SSD: Instalacja dysku SSD M.2 2230 / M.2 SSD: M.2 2230 SSD nasıl yüklenir / M.2 SSD : M.2 2230 SSD 安裝方式 / M.2 SSD: 如何安裝 M.2 2230 SSD / M.2 SSD : M.2 2230 SSDのインストール方法 / M.2 SSD: M.2 2230 SSD 설치 방법

1

Carefully insert the M.2 SSD into slot B.
小心地把 M.2 SSD 裝入 B 插槽。

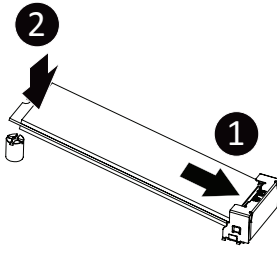

2

Insert the tab on the thermal plate into the slit near the connector, then secure the thermal plate and M.2 SSD in place with a small screw.
把散熱片裝入插槽旁邊的缺口，然後用一顆螺絲將 M.2 SSD 與散熱片固定。

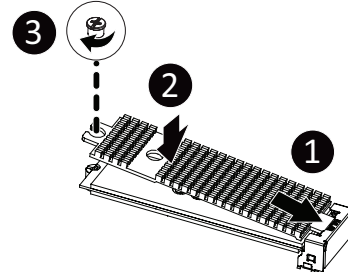

C) Memory Installation: SO-DIMM DDR4

Arbeitsspeicher Installation: SO-DIMM DDR4 / Installation de la mémoire : SO-DIMM DDR4 / Instalación de la memoria: SO-DIMM DDR4 / Instalação de memória: SO-DIMM DDR4 / Installazione della memoria: SO-DIMM DDR4 / Установка модулей памяти: SO-DIMM DDR4 / Instalacja pamięci: SO-DIMM DDR4 / Hafıza Yükleme: SO-DIMM DDR4 / 安裝記憶體: SO-DIMM DDR4 / 内存安装: SO-DIMM DDR4 / 메모리 설치: SO-DIMM DDR4

1

Carefully insert SO-DIMM memory modules.
小心並由下至上安裝 SO-DIMM 記憶體於記憶體插槽。

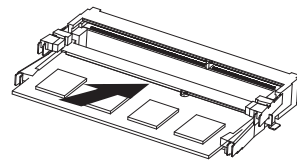

2

Push down until the modules click into place.
當記憶體固定於插槽後，再輕輕下壓至定點。

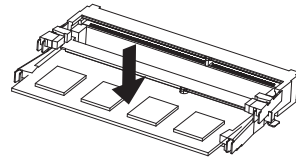

3

Carefully insert SO-DIMM memory modules.
安裝下層記憶體後，重覆前述動作安裝上層記憶體。

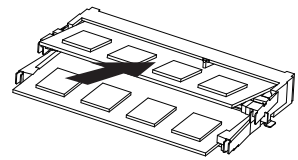

4

Push down until the modules click into place.
當記憶體固定於插槽後，再輕輕下壓至定點。

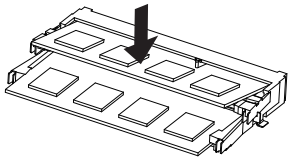

Stand Installation

Standfuß Installation / Installation du socle / Soporte vertical / Instalação no suporte / Installazione support / Установка на подставку / Montaj stojička / Stand kurulumu / 支架安裝 / 直立安裝 / 스탠드의取り付け / 스탠드 설치

1

Fit the two rubber feet onto the left side of the BRIX PRO so that the rubber pads on the bottom side of the device fits into the slot on the rubber feet.
把兩個腳座安裝在 BRIX PRO 的左側，確認 BRIX PRO 底部的皮墊有裝入腳座的凹槽中。

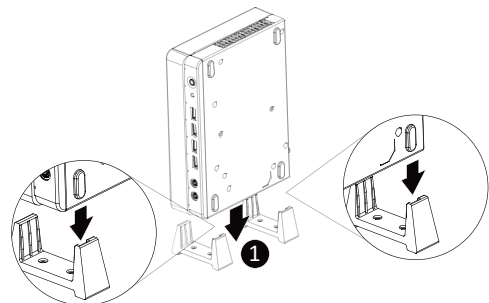

2

Ensure that the rubber feet are spaced so that the BRIX PRO is stable when upright.
妥善分配兩個腳座之間的距離，以確保 BRIX PRO 可以穩定直立擺放。

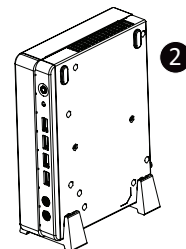

VESA Bracket

VESA Halterung / Support VESA / Soporte VESA / Soporte VESA / Staffa VESA / Кронштейн VESA / Wspornik VESA / VESA Braketi / VESA 支架 / VESA 支架 / VESA ブラケット / VESA 브래킷
NOTE! VESA screws: Length 5.0 mm with M3 type screws, Metal enclosure with bottom side.

1

Attach the screws provided on the underside of the BRIX PRO.
安裝隨附的 VESA 支撐架螺絲於 BRIX PRO 底部。

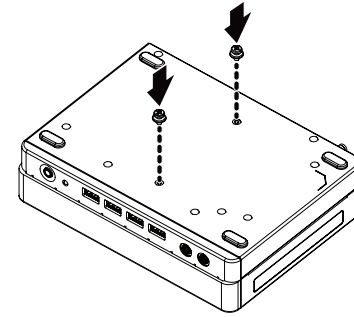

2

Attach the VESA mounting plate to the rear of a compatible display using the screws provided.
安裝隨附的 VESA 支撐架於支援 VESA 支撐架的電腦螢幕或電視機後背。

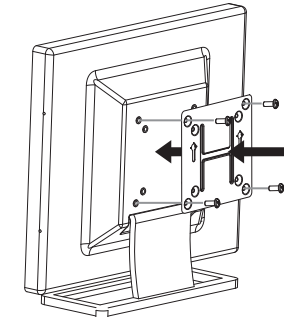

3

The BRIX PRO can now be mounted by sliding the device into place.
將已安裝 VESA 支撐架螺絲的 BRIX PRO 插入 VESA 支撐架的滑軌孔，向下壓至定位點後即可固定。

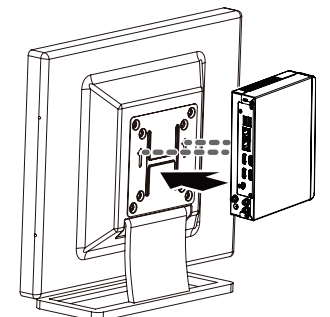

單元 Unit	限用物質及其化學符號 Restricted substances and its chemical symbols					
	鉛 Lead (Pb)	汞 Mercury (Hg)	鎘 Cadmium (Cd)	六價鉻 Hexavalent chromium (Cr ⁺⁶)	多溴聯苯 Polybrominated biphenyls (PBB)	多溴二苯醚 Polybrominated diphenyl ethers (PBDE)
電路板總成	—	○	○	○	○	○
散熱器	○	○	○	○	○	○
外殼	○	○	○	○	○	○
電源供應器	—	○	○	○	○	○
線材	—	○	○	○	○	○

備考 1. “超出 0.1 wt %”及“超出 0.01 wt %”係指限用物質之百分比含量超出百分比含量基準值。

Note 1: “Exceeding 0.1 wt %” and “exceeding 0.01 wt %” indicate that the percentage content of the restricted substance exceeds the reference percentage value of presence condition.

備考 2. “○”係指該項限用物質之百分比含量未超出百分比含量基準值。

Note 2: “○” indicates that the percentage content of the restricted substance does not exceed the percentage of reference value of presence.

備考 3. “—”係指該項限用物質為排除項目。

Note 3: The “—” indicates that the restricted substance corresponds to the exemption.