

FUJITSU LIFEBOOK U7312
FUJITSU LIFEBOOK U7412
FUJITSU LIFEBOOK U7512



Congratulations on your purchase of an innovative product from Fujitsu.

The latest information about our products, tips, updates etc. can be found on the Internet at: ["http://www.fujitsu.com/fts/"](http://www.fujitsu.com/fts/)

You can find driver updates at: ["http://support.ts.fujitsu.com/download"](http://support.ts.fujitsu.com/download)

Should you have any technical questions, please contact:

- our Hotline/Service Desk (["http://support.ts.fujitsu.com/contact/service desk"](http://support.ts.fujitsu.com/contact/service desk))
- Your sales partner
- Your sales office

We hope you enjoy working with your new Fujitsu system!



Issued by / EU importer

Fujitsu Technology Solutions GmbH

Mies-van-der-Rohe-Straße 8

80807 Munich, Germany

Name and address of the importer in the UK

Fujitsu Services Limited

22 Baker Street, London, W1U 3BW,

United Kingdom

["http://www.fujitsu.com/fts/"](http://www.fujitsu.com/fts/)

Copyright

© Fujitsu Client Computing Limited2022. All rights reserved.

Publication Date

06/2022

Edition 1

FUJITSU LIFEBOOK U7312

FUJITSU LIFEBOOK U7412

FUJITSU LIFEBOOK U7512

Operating Manual

Innovative technology	7
Ports and controls	9
Important notes	18
First-time setup of your device	22
Working with the notebook	25
Security functions	53
Connecting external devices	59
Removing and installing components during servicing	65
Settings in BIOS Setup Utility	66
Troubleshooting and tips	71
Technical data	79
Manufacturer's notes	82
Index	83

Remarks

Information on the product description meets the design specifications of Fujitsu and is provided for comparison purposes. Several factors may cause the actual results to differ. Technical data is subject to change without prior notification. Fujitsu rejects any responsibility with regard to technical or editorial mistakes or omissions.

Trademarks

Fujitsu, the Fujitsu logo and LIFEBOOK are registered trademarks of Fujitsu Limited or its subsidiaries in the USA and other countries.

Microsoft and Windows are trademarks or registered trademarks of Microsoft Corporation in the USA and/or other countries.



The terms HDMI and HDMI High-Definition Multimedia Interface and the HDMI logo are trademarks or registered trademarks of HDMI Licensing Administrator, Inc. in the United States and other countries.

Adobe Reader is a trademark of Adobe Systems Incorporated.

USB Type-C™ and USB-C™ are trademarks of the USB Implementers Forum in the USA and other countries.

All other trademarks specified here are the property of their respective owners.

Copyright

No part of this publication may be copied, reproduced or translated without the prior written consent of Fujitsu.

No part of this publication may be saved or transferred by any electronic means without the written approval of Fujitsu.

Contents

Innovative technology	7
Further information	7
Notational conventions	8
Ports and controls	9
FUJITSU LIFEBOOK U7312	9
FUJITSU LIFEBOOK U7412	12
FUJITSU LIFEBOOK U7512	15
Important notes	18
Safety notes	18
Additional safety notes for devices with wireless components	19
Energy saving	19
Energy saving under Windows	19
Travelling with your notebook	20
Before you travel	20
Notebook: transporting	20
Cleaning the notebook	21
If liquid is accidentally spilled on the notebook during use:	21
First-time setup of your device	22
Unpacking and checking the device	22
Selecting a location	23
Connecting the mains adapter	23
Switching on the device for the first time	24
Working with the notebook	25
Status indicators	25
Switching on the notebook	27
Switching off the notebook	27
Keyboard	28
Virtual numeric keypad	30
Separate number block	31
Function keys and key combinations	31
F-Lock setting	34
Keyboard with background lighting (optional)	34
Country and keyboard settings	34
Touchpad and touchpad buttons	35
Moving the pointer	35
Selecting an item	35
Executing commands	35
Dragging items	36
Touchscreen/LCD screen without touch function (device-dependent)	36
Using fingers	37
WebCam and Infrared Camera	38
ePrivacy Filter (optional)	38
Rechargeable battery	39
Charging, caring for and maintaining the battery	39
Switch the battery off and on	40
Using the power-management features	41
Adjusting system performance in Microsoft Windows	41
Adjusting fan control	42

Memory cards	43
Supported format	43
Inserting the memory card	43
Removing the memory card	43
Loudspeakers and microphones	44
SIM card (configuration dependent)	45
Inserting the SIM card	45
Removing the SIM card	46
Wireless components: wireless LAN / Bluetooth / LTE / 5G (optional)	47
Switching the wireless components on and off	47
Setting up WLAN access	47
Access via LTE / 5G (optional)	47
Ethernet and LAN	48
FUJITSU LIFEBOOK U7312	48
FUJITSU LIFEBOOK U7412 / FUJITSU LIFEBOOK U7512	48
Your Port Replicator	49
Ports on the Port Replicator	49
Connecting the notebook to the Port Replicator	50
Connecting the mains adapter to the Port Replicator	51
Switching on the notebook via the port replicator	51
Disconnecting the notebook from the Port Replicator	52
Security functions	53
Configuring the fingerprint sensor	53
Configuring the palm vein sensor	54
Using the Security Lock	54
Configuring password protection in BIOS Setup Utility	55
Protecting BIOS Setup Utility (supervisor and user password)	55
Password protection for booting of the operating system	57
Password protection for the drive	57
SmartCard reader	58
Inserting the SmartCard	58
Connecting external devices	59
Connecting an external monitor	60
Connecting USB devices	61
USB port Intel® Thunderbolt™ 4 with charging function and display port (USB Type-C)	62
USB port with charging function (Anytime USB charge)	63
How to remove USB devices correctly	63
Headset port	64
Removing and installing components during servicing	65
Settings in BIOS Setup Utility	66
Starting the BIOS Setup Utility	66
Operating the BIOS Setup Utility	67
Exiting BIOS Setup Utility	68
Exit Saving Changes - save changes and exit BIOS Setup Utility	68
Exit Discarding Changes – Discard changes and exit BIOS Setup Utility	68
Load Setup Defaults – Copy Standard Entries	68
Discard Changes – Discard changes without exiting the BIOS Setup Utility	68
Save Changes - save changes without exiting the BIOS Setup Utility	68
Save Changes and Power Off	68
Erase Disk	69

Troubleshooting and tips	71
Help if problems occur	71
Recovering drive contents from the Recovery DVD	72
Restoring the system under Windows	72
The notebook's date or time is incorrect	72
When certain characters are entered on the keyboard, only numerals are written	73
The notebook's LCD screen remains blank	73
The LCD screen is difficult to read	73
The external monitor remains blank	73
The external monitor is blank or the image is unstable	74
The notebook cannot be started	74
The notebook stops working	74
The printer does not print	75
The wireless connection to a network does not work	75
SmartCard reader is not recognised.	75
SmartCard PIN forgotten	75
SmartCard lost	76
Error messages on the screen	77
Technical data	79
LIFEBOOK	79
Rechargeable battery	80
Mains adapter (notebook computer)	80
Mains adapter (port replicator)	81
Manufacturer's notes	82
Disposal and recycling	82
TCO Certified	82
SAR limit value (Specific Absorption Rate)	82
Other certification markings	82
Index	83

Innovative technology

... and ergonomic design make your device a reliable and convenient companion.

The device boots very quickly, is ready for immediate use and offers a particularly long operating time because of its high capacity battery.

With the user-friendly "BIOS Setup Utility" you can control your notebook's hardware and better protect your system against unauthorised access by using the powerful password properties.



Information on the connections and user components of your notebook can be found in ["Ports and controls", Page 9.](#)

Further information







The Windows drivers for your device can be found on our Internet site. The factory installation of your device does not support any other operating system. Fujitsu Technology Solutions accepts no liability whatsoever if any other operating system is used.

Software oriented components of these instructions refer to Microsoft products, if they come within the scope of the delivery.

If you install other software products, pay attention to the operating instructions of the manufacturer.

Notational conventions

	Pay particular attention to text marked with this symbol. Failure to observe these warnings could pose a risk to health, damage the device or lead to loss of data. The warranty will be invalidated if the device becomes defective through failure to observe these warnings.
	Indicates important information for the proper use of the device.
	Indicates an activity that must be performed
	Indicates a result
This font	indicates data entered using the keyboard in a program dialogue or at the command line, e.g. your password (Name123) or a command used to start a program (start.exe)
This font	indicates information that is displayed on the screen by a program, e.g.: Installation is complete.
<i>This font</i>	Indicates <ul style="list-style-type: none"> • terms and texts used in a software interface, e.g.: Click on <i>Save</i> • names of programs or files, e.g. <i>Windows</i> or <i>setup.exe</i>.
"This font"	Indicates <ul style="list-style-type: none"> • cross-references to another section, e.g. "Safety information" • cross-references to an external source, e.g. a web address: For more information, go to "http://www.fujitsu.com/fts/" • Names of CDs, DVDs and titles or designations for other materials, e.g.: "Drivers & Utilities" DVD or "Safety/Regulations" Manual
Key	indicates a key on the keyboard, e.g: F10
This font	indicates terms and texts that are emphasised or highlighted, e.g.: Do not switch off the device

Ports and controls

This chapter presents the individual hardware components of your device. It gives an overview of the indicators and ports of the device. Please familiarise yourself with these components before you start to work with the device.

FUJITSU LIFEBOOK U7312

Front

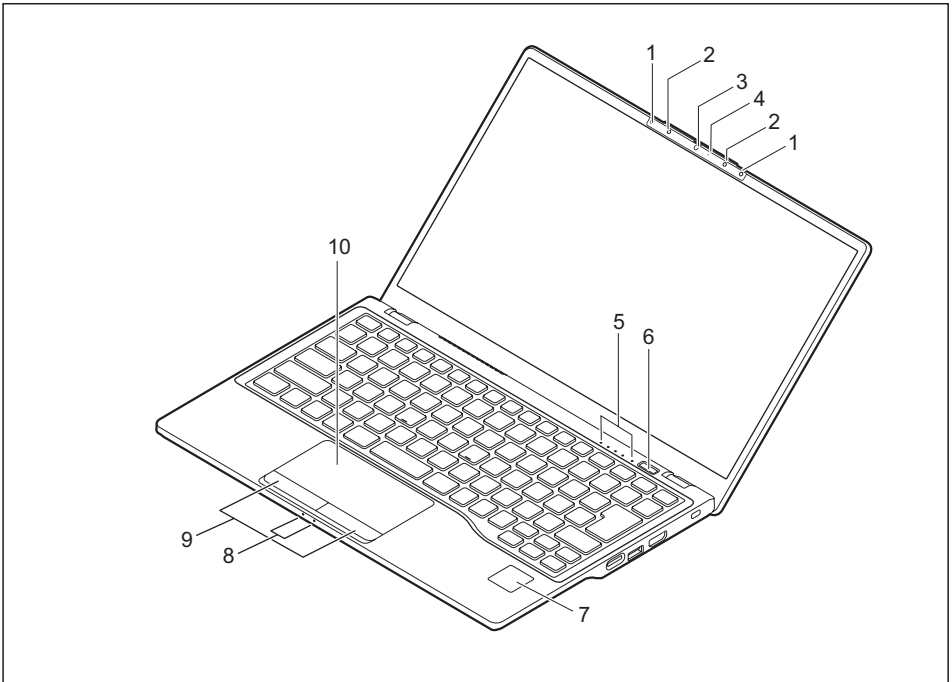

- 1 = Infra-red camera sensors (optional)
- 2 = Microphone (optional)
- 3 = WebCam (optional) with webcam shutter
- 4 = WebCam LED (optional)
- 5 = Status indicators
- 6 = ON/OFF button

- 7 = Fingerprint sensor (optional) or palm sensor (optional)
- 8 = Status indicators
- 9 = Touchpad buttons
- 10 = Touchpad

Left side

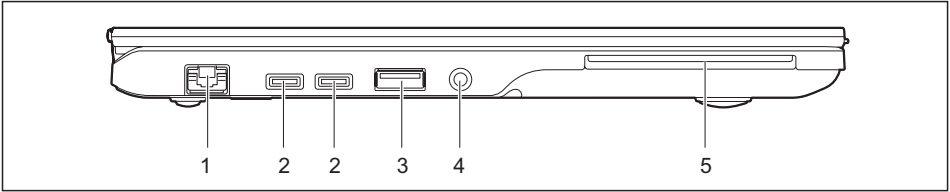

- 1 = LAN port (fold out)
- 2 = USB ports Intel® Thunderbolt™ 4 with charging function and display port (USB Type-C)
- 3 = USB 3.2 Gen1 port with charging function (USB Type-A, Anytime USB charge)
- 4 = Headset jack
- 5 = SmartCard reader (optional)

Right side

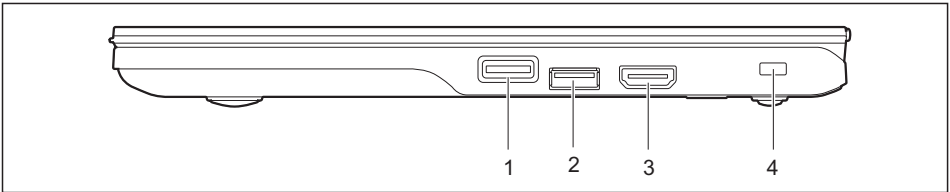

- 1 = Memory card slot
- 2 = USB port 3.2 Gen1 (USB Type-A)
- 3 = HDMI port
- 4 = Security Lock device

Rear

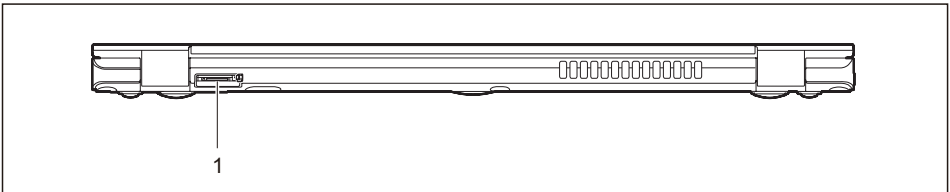

- 1 = SIM card slot (configuration-dependent, protected by cover)

Bottom

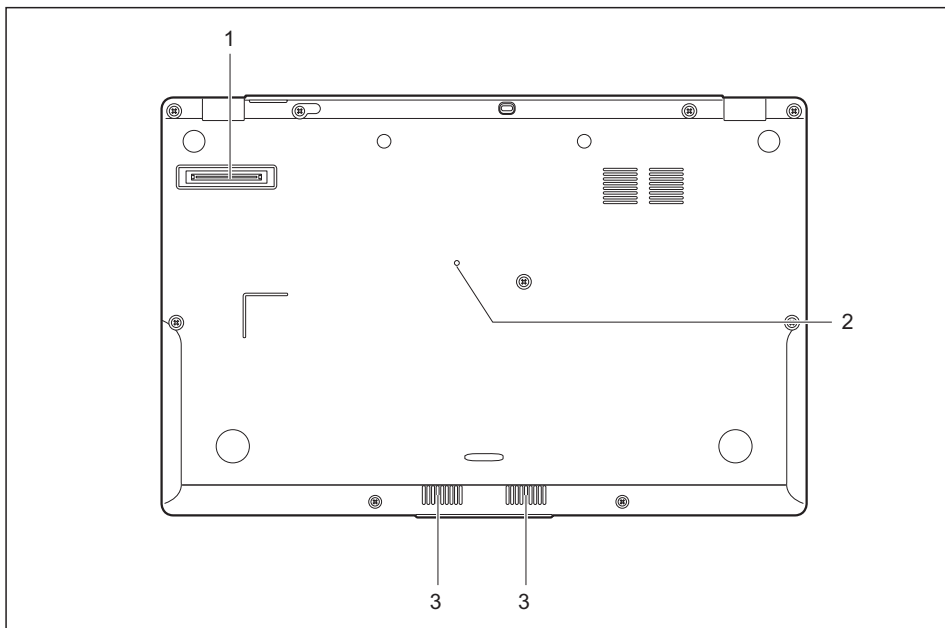

1 = Port Replicator port

2 = Off button for the battery (recessed)

3 = Loudspeakers

FUJITSU LIFEBOOK U7412

Front

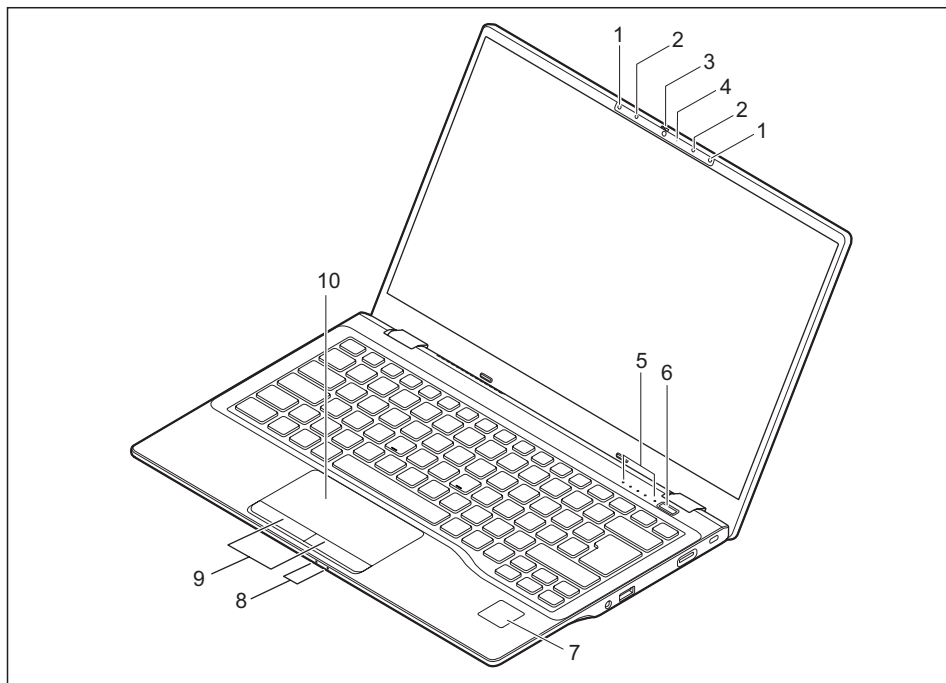

- 1 = Infra-red camera sensors (optional)
- 2 = Microphone (optional)
- 3 = WebCam (optional) with webcam shutter
- 4 = WebCam LED (optional)
- 5 = Status indicators
- 6 = Power Button

- 7 = Fingerprint sensor (optional) or palm sensor (optional)
- 8 = Status indicators
- 9 = Touchpad buttons
- 10 = Touchpad

Left side

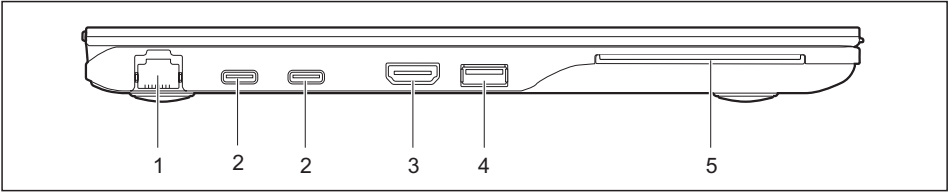

- 1 = LAN port
- 2 = USB ports Intel® Thunderbolt™ 4 with charging function and display port (USB Type-C)
- 3 = HDMI port
- 4 = USB 3.2 Gen1 port with charging function (USB Type-A, Anytime USB charge)
- 5 = SmartCard reader (optional)

Right side

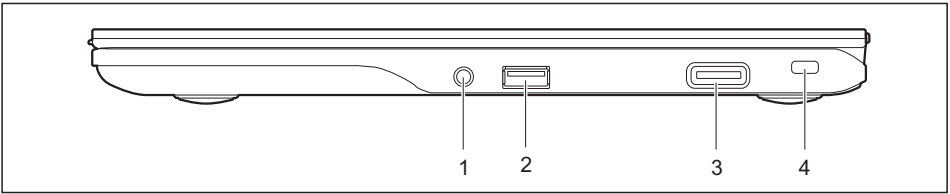

- 1 = Headset port
- 2 = USB port 3.2 Gen1 (USB Type-A)
- 3 = Memory card slot
- 4 = Security lock device

Rear

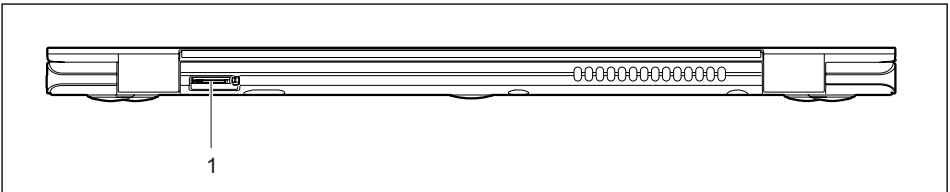

- 1 = SIM card slot (configuration-dependent, protected by cover)

Bottom

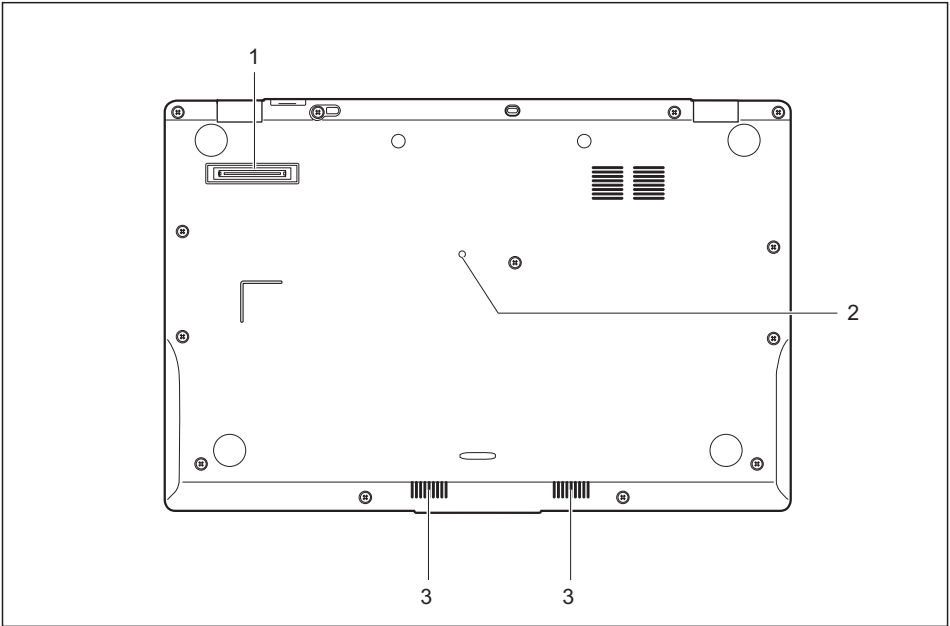

1 = Port Replicator port

3 = Loudspeaker

2 = Off button for the battery (recessed)

FUJITSU LIFEBOOK U7512

Front

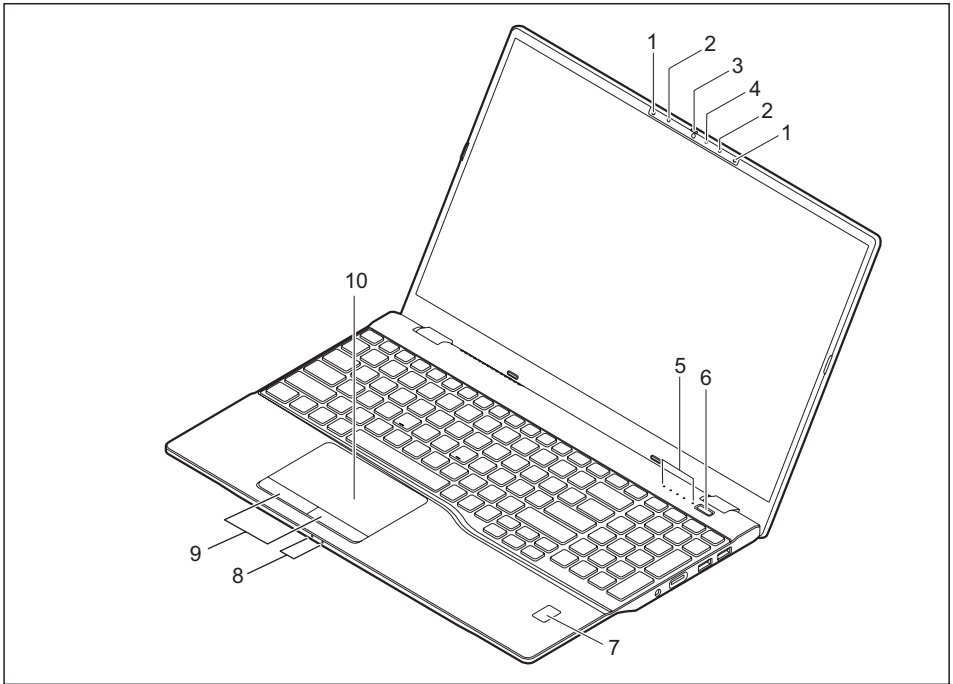

- 1 = Infra-red camera sensors (optional)
- 2 = Microphone (optional)
- 3 = WebCam (optional) with webcam shutter
- 4 = WebCam LED (optional)
- 5 = Status indicators
- 6 = ON/OFF button

- 7 = Fingerprint sensor (optional) or palm sensor (optional)
- 8 = Status indicators
- 9 = Touchpad buttons
- 10 = Touchpad

Left side

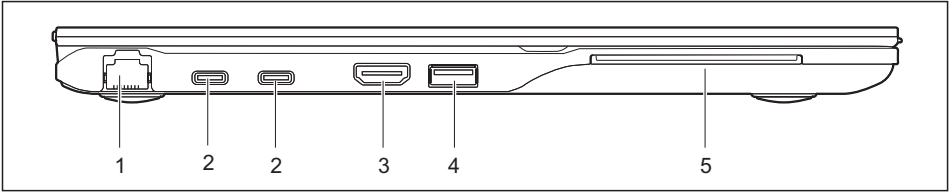

- 1 = LAN port
- 2 = USB ports Intel® Thunderbolt™ 4 with charging function and display port (USB Type-C)
- 3 = HDMI port
- 4 = USB 3.2 Gen1 port with charging function (USB Type-A, Anytime USB charge)
- 5 = SmartCard reader (optional)

Right side

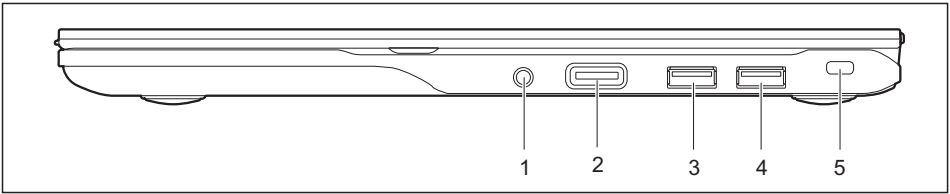

- 1 = Headset port
- 2 = Memory card slot
- 3 = USB port 3.2 Gen1 (USB Type-A)
- 4 = USB port 3.2 Gen1 (USB Type-A)
- 5 = Security Lock Device

Rear

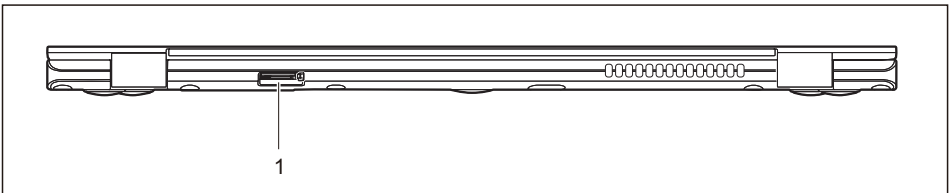

- 1 = SIM card slot (configuration-dependent, protected by cover)

Bottom

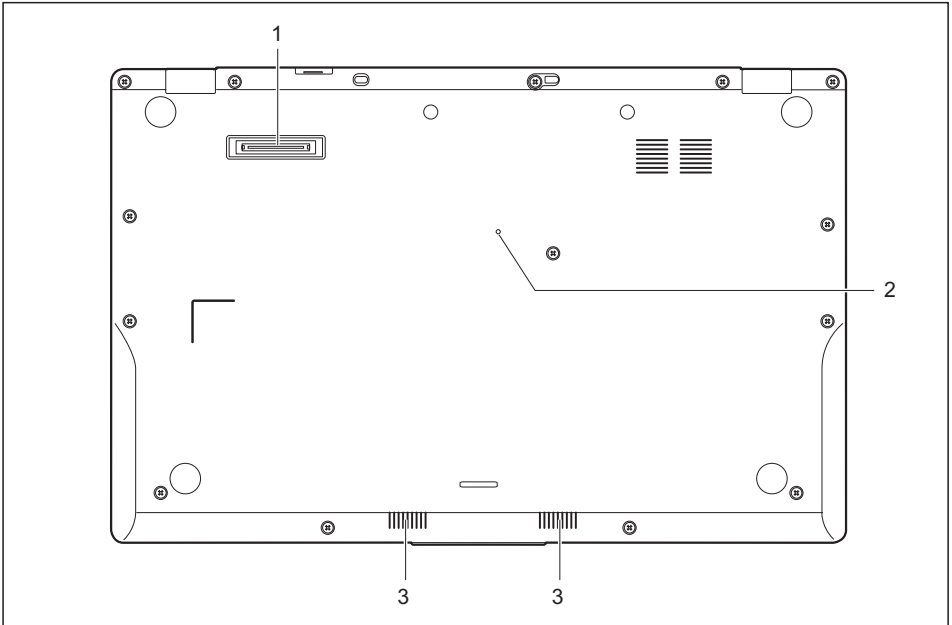

1 = Port replicator port

2 = Off button for the battery (recessed)

3 = Loudspeakers

Important notes



This chapter contains essential safety information which must be followed when working with your notebook. Other notes also provide useful information which will help you with your notebook.

Safety notes



Please follow the safety notes provided in the "Safety/Regulations" manual as well as the safety notes given below.

Please pay special attention to the sections in the manual marked with the symbol on the left.

When connecting and disconnecting cables, observe the relevant notes in this operating manual.

In order to prevent burn injury or the device from overheating, do not lay the device directly on your lap and make sure that the ventilation openings are not obstructed.

Read the information on the ambient conditions in the ["Technical data", Page 79](#) and ["First-time setup of your device", Page 22](#) before preparing your notebook for use and switching it on for the first time.

When cleaning the device, please observe the relevant notes in the section ["Cleaning the notebook", Page 21](#).

Pay attention to the additional safety notes for devices with wireless components provided in the "Safety/Regulations" manual.

Please refer to the notes in the chapter ["Removing and installing components during servicing", Page 65](#).

This notebook complies with the relevant safety regulations for data processing equipment. If you have questions about using your notebook in a particular area, please contact your sales outlet or our Hotline/Service Desk.

Opening angle of the LCD screen

Please open the LCD screen carefully until you feel resistance. Do not try to open it further with force!

To open it, take hold of the screen in the centre of the front by the slightly protruding grip edge.

Additional safety notes for devices with wireless components

If a wireless component (Wireless LAN, Bluetooth, UMTS, LTE, 5G) is incorporated in your notebook, you must be sure to observe the following safety notes when using your notebook:

- Switch off the wireless components when you are in an aircraft or driving in a car.
- Switch off the wireless components when you are in a hospital, an operating room or near a medical electronics system. The transmitted radio waves can impair the operation of medical devices.
- Switch off the wireless components when you let the device get near flammable gases or into hazardous environments (e.g. petrol station, paintshops), as the transmitted radio waves can cause an explosion or a fire.



For information on how to switch wireless components on and off, see chapter "[Switching the wireless components on and off](#)", Page 47.

Energy saving

Switch the notebook off when it is not in use. Switch off external, connected devices if you are not using them. If you use the energy saving functions, the notebook uses less energy. You will then be able to work for longer before having to recharge the battery.



Energy efficiency is increased and the environmental impact is reduced. You save money while protecting the environment.

Energy saving under Windows

- ▶ Make use of the power management features (see "[Using the power-management features](#)", Page 41").

Travelling with your notebook

Please observe the points listed below when travelling with your notebook.

Before you travel

- ▶ Backup important data stored on the drives.
- ▶ Switch off the wireless component for data security reasons. With data traffic via a wireless connection, it is also possible for unauthorised third parties to receive data.



Information on activating data encryption is provided in the documentation for your wireless component.

- ▶ If you wish to use your notebook during a flight, first check with the flight attendants if it is OK to do so.

When travelling in other countries

- ▶ If you are travelling abroad, check that the mains adapter can be operated with the local mains voltage. If this is not the case, obtain the appropriate mains adapter for your notebook. Do not use any other voltage converter!
- ▶ Check whether the local mains voltage and the power cable are compatible. If this is not the case, buy a power cable that matches the local conditions.
- ▶ Contact the relevant authorities of the country you will be travelling in as to whether you may operate the radio component integrated into your notebook computer. Please observe the additional safety instructions for devices with radio components, found in the handbook "Safety/formalities".

Notebook: transporting



Protect the notebook from severe shocks and extreme temperatures (e.g. direct sunlight in a car).

- ▶ Switch the notebook off.
- ▶ Unplug the mains adapter and all external devices from the power socket.
- ▶ Disconnect the mains adapter cable and the data cables for all external devices.
- ▶ Close the LCD screen.
- ▶ To protect against damaging jolts and bumps, use a notebook carrying case to transport your notebook.

Cleaning the notebook



Do not clean any interior parts yourself; leave this job to a service technician.

Only use cleaning products designed for computers. Normal household cleaners and polishes can damage the markings on the keyboard and the device, the paintwork or the notebook itself.

Ensure that no liquid enters the notebook.

The LCD screen very sensitive to scratches. Only clean the display surface with a very soft, slightly damp cloth.

- ▶ Switch the notebook off.
- ▶ To prevent the device from being switched on unintentionally, remove the AC plug of the power adapter from the power outlet and switch off the battery (see chapter ["Switch the battery off and on", Page 40](#)).



The surface can be cleaned with a dry cloth. If particularly dirty, use a damp cloth that has been dipped in water mixed with mild domestic detergent and then carefully wrung out.

You can use disinfectant wipes to clean the keyboard and the touchpad.

Ensure that no liquid enters the device.

- ▶ Do not spray any liquid on the device!

If liquid is accidentally spilled on the notebook during use:

- ▶ Switch off the notebook and remove the power adapter.
- ▶ Turn the notebook over so as to let the liquid run out of it.
- ▶ Disconnect the battery (see Chapter ["Switch the battery off and on", Page 40](#)).
- ▶ Allow the notebook to dry for at least 24 hours.
- ▶ If the notebook cannot be switched on after reconnecting the power adapter, please contact our Hotline/Service desk.

First-time setup of your device



Please read the chapter ["Important notes", Page 18.](#)

If your device is equipped with a Windows operating system, the necessary hardware drivers and supplied software are already pre-installed.

Before you switch on the device for the first time, connect it to the mains voltage using the mains adapter, see ["Connecting the mains adapter", Page 23.](#) The mains adapter must be connected during the entire installation process.

A system test is performed when your device is first switched on. Various messages can appear. The display may remain dark for a short time or may flicker.

Please follow the instructions on the screen.

NEVER switch off your device during the first-time setup process.

When the device is delivered, the battery is located in the battery compartment. The battery must be charged if you want to operate your device using the battery.

When used on the move, the built-in battery provides the device with the necessary power. You can increase the operating time by using the available energy-saving functions.

For instructions on how to connect external devices (e.g. mouse, printer) to your device, please refer to the operating manual for your device.

Unpacking and checking the device



Should you discover any damage that occurred during transportation, notify your local sales outlet immediately!

- ▶ Unpack all the individual parts.
- ▶ Check your device for any visible damage which may have occurred during transportation.



You may need the packaging in the future, if you need to transport your device.

Selecting a location



Select a suitable location for the device before setting it up. Follow the instructions below when doing so:

- Never place the device or the mains adapter on a heat-sensitive surface. The surface could be damaged as a result.
- Never place the device on a soft surface (e.g. carpeting, upholstered furniture, bed). This can block the air vents and cause overheating and damage.
- The underside of the device heats up during normal operation. Prolonged contact with the skin may become unpleasant or even result in burns.
- Place the device on a stable, flat, non-slippery surface. Please note that the rubber feet of the device may mark certain types of delicate surfaces.
- Keep other objects at least 100 mm / 3.94 inches away from the device and its mains adapter to ensure adequate ventilation.
- Never cover the ventilation slots of the device.
- Do not expose the device to extreme environmental conditions. Protect the device from dust, humidity, and heat.

Connecting the mains adapter



Observe the safety notes in the enclosed "Safety/Regulations" manual.

The supplied power cable conforms to the requirements of the country in which you purchased your device. Make sure that the power cable is approved for use in the country in which you intend to use it.

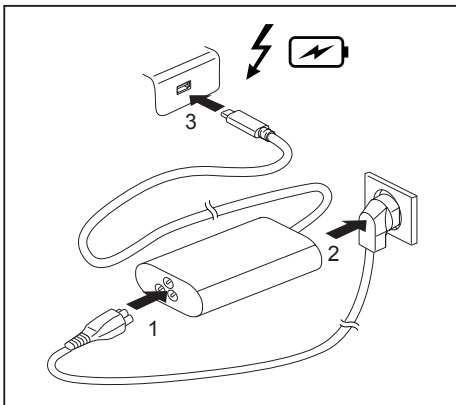

- ▶ Connect the power cable (1) to the power adapter provided for the device, see chapter "[Technical data](#)", Page 79.
- ▶ Plug the mains cable (2) into a mains outlet.
- ▶ Connect the USB Type-C cable (3) of the power adapter to one of the two Intel® Thunderbolt™ 4 USB power ports of the device.

Switching on the device for the first time



When you switch on the device for the first time, the supplied software is installed and configured. Because this procedure must not be interrupted, you should set aside enough time for it to be fully completed and connect the device to the mains using the mains adapter.

During the installation process, DO NOT restart the device unless you are requested to do so!

To make it easier to use your device for the first time, the operating system is pre-installed on the drive.

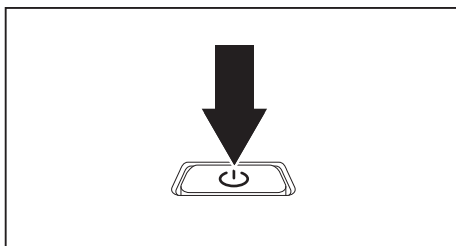

► Switch on your device.

► During installation, follow the instructions on screen.



If a Windows operating system is installed on your device, you will find more information on the system and drivers, help programmes, updates, manuals etc. on the device or on the Internet under "<http://www.fujitsu.com/fts/support/>".

You can find information and help on the Windows operating system functions on the Internet at "<http://windows.microsoft.com/>".

Working with the notebook

This chapter describes the basics for operating your notebook. Please read the chapter entitled ["Connecting external devices", Page 59](#) for instructions on how to connect devices such as a mouse and a printer to the notebook.









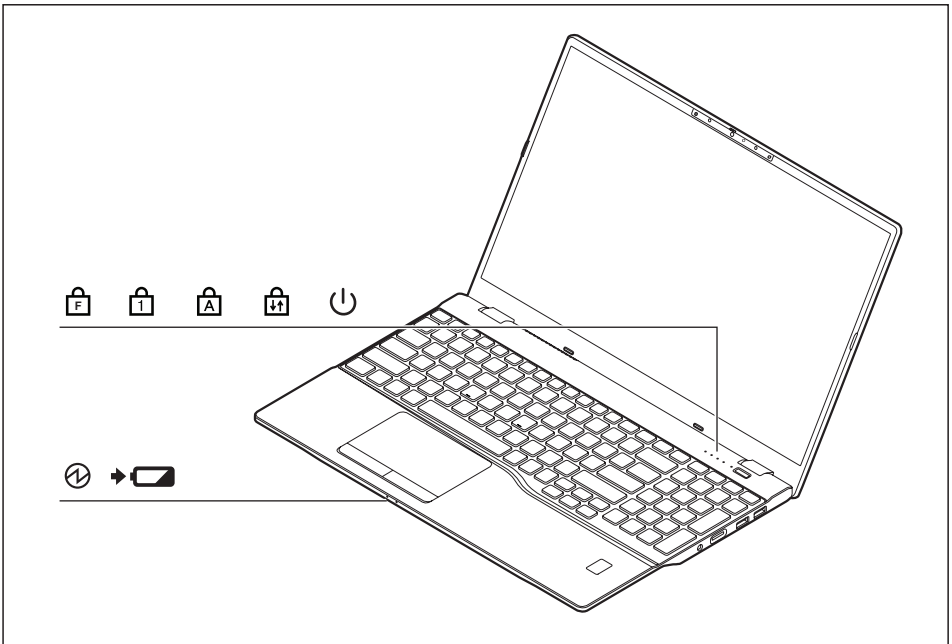



Please refer to the notes in ["Important notes", Page 18](#).

Status indicators

The status indicators provide information about the status of the power supply and of the keyboard functions.



Indicator	Description
	<p>Power-on indicator / Standby</p> <ul style="list-style-type: none"> Indicator is illuminated: The notebook is switched on. Indicator flashes: The notebook is in standby mode. Indicator is off: The notebook is switched off.
	<p>Battery status indicator/mains connection The state of charge of the battery is shown by the battery indicator.</p> <ol style="list-style-type: none"> With AC adapter connected: <ul style="list-style-type: none"> The indicator lights up orange: The battery is charging. The indicator is off: Charging is completed. The indicator flashes orange: The battery cannot be charged as the battery is too hot or cold for charging. The charging process is continued as soon as the battery reaches a permissible temperature again. Running on battery (without AC adapter): <ul style="list-style-type: none"> The indicator is off: Battery level is 100-21%. The indicator lights up red: Battery level is 20-0%. Battery abnormality/error: The indicator flashes red.
	<p>F Lock indicator</p> <p>The indicator lights up: The key combination  +  has been pressed. Instead of the imprinted standard functions of the function keys, the Fn functions can be executed by pressing the keys directly (see chapter "Function keys and key combinations", Page 31).</p>
	<p>Num Lock indicator</p> <p>Indicator is illuminated: The  key has been pressed. The virtual numerical keypad is activated. You can output the characters indicated on the upper right of the keys.</p>
	<p>Caps Lock indicator</p> <p>Indicator is illuminated: The Caps Lock key has been pressed. All the characters you type will appear in upper case. In the case of overlay keys, the character printed on the upper left of the key will appear when that key is pressed.</p>
	<p>Scroll Lock indicator</p> <p>Indicator is illuminated: the key combination  +  has been pressed. The effect that this key has varies between applications.</p>

Switching on the notebook

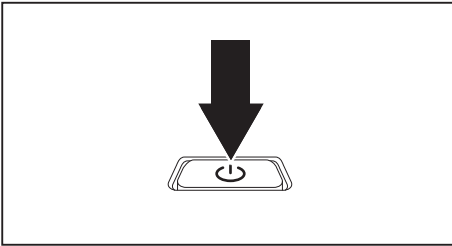

↳ The power-on indicator is lit.

- ▶ Open the LCD screen.
- ▶ Press the ON/OFF button for about 1 second to switch the notebook on.

Switching off the notebook



Back up your data and close all applications before you switch off your device. Otherwise data might be lost.

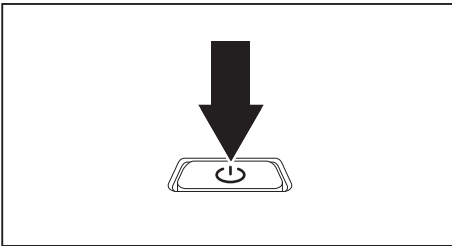

- ▶ Shut down the operating system correctly.
- ▶ If the notebook does not switch itself off automatically, press the ON/OFF button for about 5-10 seconds.
- ▶ Close the LCD screen.

Keyboard



The keyboard of your notebook is subject to continuous wear through normal use. The key markings are especially prone to wear. The key markings are liable to wear away over the life of the notebook.

The keyboard has been designed to provide all the functions of an enhanced keyboard. Some enhanced keyboard functions are mapped with key combinations.







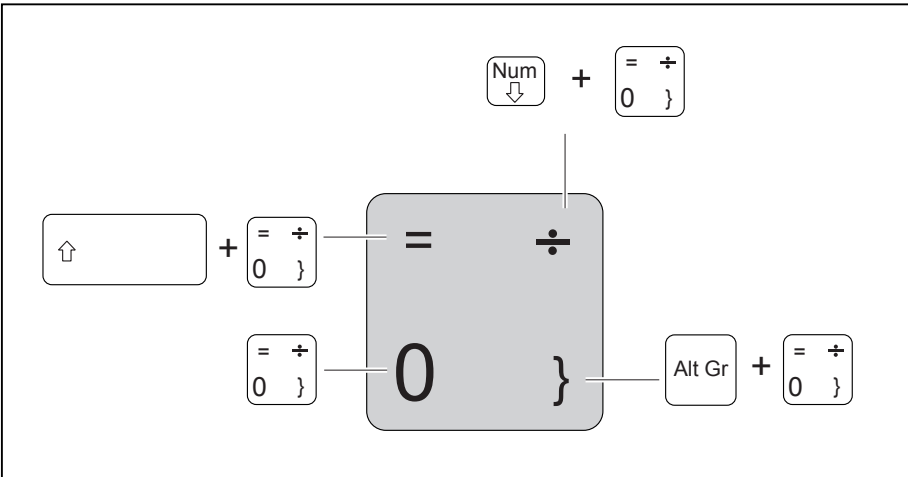

The following description of keys refers to Windows. Additional functions supported by the keys are described in the relevant manuals supplied with your application programs.

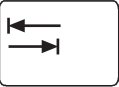
The figure below shows how to access the different characters on keys with overlaid functions. The example applies when the Caps Lock key has not been activated.



The illustrations shown below may differ from your actual device.

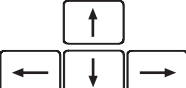

Key	Description
	<p>Backspace key The Backspace key deletes the character to the left of the cursor.</p>
	<p>Tab key The Tab key moves the cursor to the next tab stop.</p>
	<p>Enter key (return) The Enter key terminates a command line. The command you have entered is executed when you press this key.</p>
	<p>Caps Lock key The Caps Lock key activates the Caps Lock mode, and the corresponding icon is displayed in the Windows information area. In Caps Lock mode, all of the characters you type appear in upper case. In the case of overlay keys, the character printed on the upper left of the key will appear when that key is pressed. To cancel the Caps Lock function, simply press the Caps Lock key again.</p>
	<p>Shift key The Shift key causes uppercase characters to appear. In the case of overlay keys, the character printed on the upper left of the key appears when that key is pressed.</p>
	<p>Fn key The  key activates the Fn function of an overlay key (see chapter "Function keys and key combinations", Page 31).</p>
	<p>Cursor keys The cursor keys move the cursor in the direction of the arrow, i.e. up, down, left, or right.</p>
	<p>Windows key The Windows key switches between the start screen and the last used application.</p>
	<p>Menu key The Menu key opens the menu for the active application.</p>

Virtual numeric keypad



LIFEBOOK U7312 and LIFEBOOK U7412 have virtual number blocks, LIFEBOOK U7512 has a separate number block.

To provide the convenience of a numeric keypad, your keyboard is equipped with a virtual numeric keypad. The special keys of the virtual numeric keypad are recognisable by the numbers and symbols printed in the upper right corner of each key. If you have switched on the virtual numeric keypad, you can output the characters shown on the upper right of the keys.



The keyboard layout shown below may differ from your actual device.

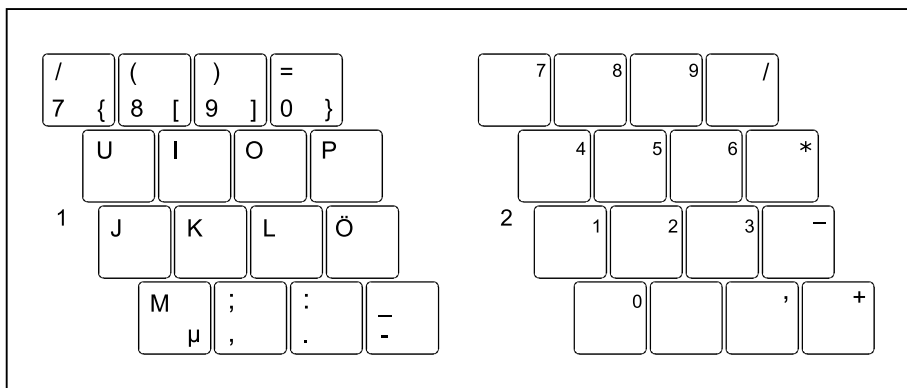

1 = Valid characters when the **Num** key is not activated

2 = Valid characters when the **Num** is activated

Further information about the status indicators can be found in chapter ["Status indicators", Page 25](#).

Default settings

With default settings, each button must be pressed in combination with **Fn** in order to enter the characters of the virtual numeric keypad.

In the BIOS setup utility, you can enable the function that allows you to enter the characters of the virtual numeric keypad directly without **Fn**.

► To do so, in the *Advanced-KeyBoard Features* menu select *On* or *Off* instead of *On/Padlock Off*.



With Windows, the Num Lock function can still be switched on and off using the *Num* key regardless of whether *On* or **Off** is set in the BIOS.

Separate number block



LIFEBOOK U7312 and LIFEBOOK U7412 have virtual number blocks,
LIFEBOOK U7512 has a separate number block.

The keyboard of your notebook has a separate number block on the far right.

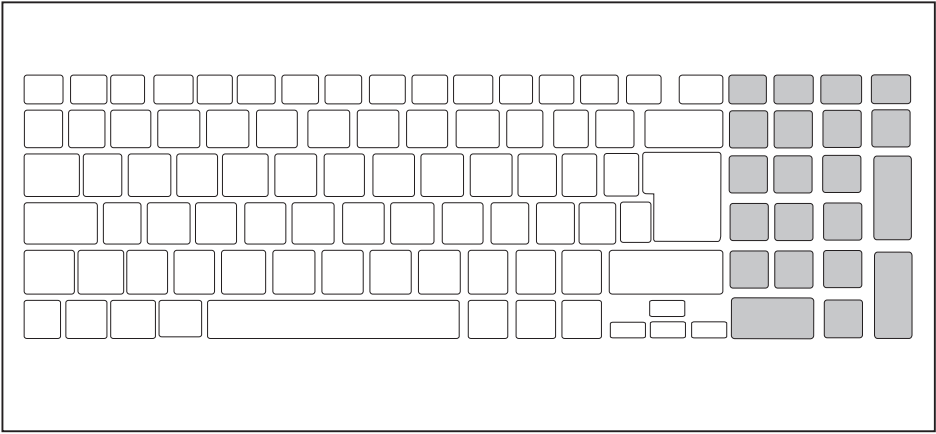

Function keys and key combinations

The following description of the function keys and key combinations applies to Windows operating systems. Some of the functions described below may not work in other operating systems and with some device drivers.







Other key combinations are described in the relevant manuals supplied with your application programs.

Key combinations are entered as follows:

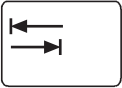
- ▶ Press the first key in the combination and keep it pressed.
- ▶ While holding the first key down, press the other key or keys in the combination.

Function key	Description
F1	Switch microphone on/off This function key switches the microphone off and on.
F2	Switching the loudspeakers on and off This function key switches the speaker of the notebook off and on.
F3	Decrease volume This function key reduces the volume of the built-in loudspeakers.







Function key	Description
F4	<p>Increase volume This function key increases the volume of the built-in loudspeakers.</p>
F5	<p>Switching the wireless components on / off This function key switches the wireless components off or on.</p>
F6	<p>Switching the touchpad and touchpad buttons on/off This function key switches the touchpad and the touchpad buttons off or on.</p>
F7	<p>Decrease screen brightness This function key decreases the brightness of the screen.</p>
F8	<p>Increase screen brightness This function key increases the brightness of the screen.</p>
F9	<p>LIFEBOOK U7512: Power management functions Use this function key to activate the energy saving functions (see chapter "Using the power-management features", Page 41).</p>
	<p>LIFEBOOK U7312 and U7412: ePrivacy Filter This function key activates and deactivates the optional side view protection (ePrivacy Filter) ("ePrivacy Filter (optional)", Page 38).</p>
F10	<p>Toggle output screen If an external monitor is connected, the screen on which the output is to be displayed can be selected with this function key. Screen output is possible:</p> <ul style="list-style-type: none"> • only on the notebook's LCD screen • on the LCD screen of the notebook and the external monitor at the same time • only on the external monitor <p>This setting is useful if you would like a high resolution and a high refresh rate on an external monitor.</p>
F11	<p>Prt Scrn This function key takes a screenshot of the current screen display and saves it to the clipboard.</p>
F12	<p>Num Lock This function key activates the virtual number block. The characters found on the upper right of the keys are then output.</p>

Combination	Description
 + 	Switch between open applications Use this key combination to switch between several open applications.
 +  + 	Windows security/Task-Manager This key combination opens the Windows security/Task-Manager window.
 + 	Back tab This key combination moves the cursor back to the previous tab stop.



Key combinations using the Windows keys are detailed in the manual for your operating system.

In addition, the following non-labelled key combinations are supported:

-  +  = Pause
-  +  = Break
-  +  = SysRq

F-Lock setting

The F-Lock setting can be used to set either the hot keys or the function keys as the primary function for the upper row of keys.

The F-Lock function is deactivated by default as delivered.

▶ F-Lock is turned on and off by pressing **[Fn] + [Esc]**.

↳ When F-Lock is turned on, it remains activated like the **[Caps Lock]** key.

Changing the F-Lock setting changes the primary and secondary key functions as follows:

Status	Hot Key	Function key
F-Lock is deactivated (F-Lock symbol is not illuminated)	The hot key functions are the primary behaviour: <ul style="list-style-type: none"> ▶ They are used by simply pressing the corresponding hot key. 	The function keys become the secondary behaviour: <ul style="list-style-type: none"> ▶ They are used by pressing [Fn] + the function key.
F-Lock is activated (F-Lock symbol is illuminated)	The hot key functions are the secondary behaviour: <ul style="list-style-type: none"> ▶ They are used by pressing [Fn] + the hot key. 	The function keys become the primary behaviour: <ul style="list-style-type: none"> ▶ They are used by simply pressing the corresponding function key.



The F-Lock toggle function can be deactivated in the BIOS setup utility.

If the F-Lock toggle function is deactivated, the F-Lock symbol is continuously on and the function keys become the primary function.

▶ To do so, in the *Advanced - Keyboard Features - F-Lock* menu select *disabled* instead of *enabled*.

Keyboard with background lighting (optional)



On this version of the keyboard, repeated pressing of the key combination **[Fn] + [space bar]** allows the background lighting to be switched on and off and also a choice to be made between two levels of brightness.

In battery mode, it is recommended to turn on the backlight only when needed and to use the lower brightness level to maximize battery life.

Country and keyboard settings

▶ Change the country and keyboard settings as described in the documentation for your operating system.

Touchpad and touchpad buttons



Keep the touchpad clean. Protect it from dirt, liquids and grease.

Never use the touchpad if your fingers are dirty.

Do not rest heavy objects (e.g. books) on the touchpad or the touchpad buttons.

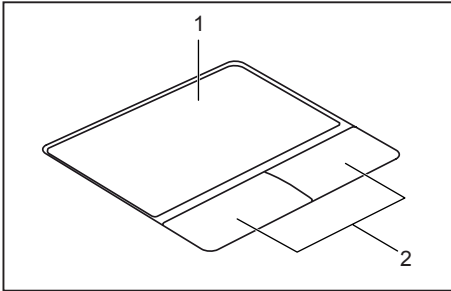

1 = Touchpad

2 = Touchpad buttons

You can move the cursor using the touchpad.

The touchpad buttons allow you to select and execute commands. They correspond to the buttons on a conventional mouse.



You can also deactivate the touchpad via the keyboard, so that you cannot move the cursor unintentionally (see chapter ["Function keys and key combinations", Page 31](#)).

Moving the pointer

- ▶ Move your finger on the touchpad.
- ↳ The pointer will move.

Selecting an item

- ▶ Move the pointer to the item you wish to select.
- ▶ Tap the touchpad once or press the left button once.
- ↳ The item is selected.

Executing commands

- ▶ Move the pointer to the field you wish to select.
- ▶ Tap the touchpad twice or press the left button twice.
- ↳ The command is executed.

Dragging items

- ▶ Select the desired item.
- ▶ Press and hold the left button and, with your finger on the touchpad, drag the item to the desired position.
- ↳ The item will be moved.

Touchscreen/LCD screen without touch function (device-dependent)

High-quality LCD screens (TFT) are installed in Fujitsu notebooks. For technical reasons, these screens are manufactured for a certain resolution. An optimum and sharp image can only be ensured with the resolution intended for the particular screen. A screen resolution which differs from the specification can result in an unclear picture.

The resolution of your notebook's screen is optimally set at the factory.

With the present standards of production technology, absolutely flawless screen images cannot be guaranteed. There may be a few constantly light or dark pixels (picture elements) on the screen. The maximum permitted number of such faulty pixels is specified in the international standard ISO 9241-307 (Class II).

Example:

A screen with an HD resolution of 1366 x 768 has 1366 x 768 = 1049088 pixels. Each pixel consists of three subpixels (red, green and blue), making a total of about 3 million subpixels. According to ISO 9241-307 (class II), a maximum of 2 light and 2 dark pixels and in addition 5 light or 10 dark subpixels or an equivalent mix (1 light subpixel counts as 2 dark subpixels) are allowed to be defective.

Pixel	A pixel consists of 3 subpixels, normally red, green and blue. A pixel is the smallest element that can be generated by complete functionality of the display.
Subpixel	A subpixel is a separately addressable internal structure within a pixel that enhances the pixel function.
Cluster	A cluster contains two or more defective pixels or subpixels in a 5 x 5 pixel block.

Background lighting

LCD screens are operated with background lighting. The luminosity of the background lighting can decrease during the period of use of the notebook. However, you can set the brightness of your screen individually.

Synchronising the display on the LCD screen and an external monitor

For more information, please refer to the chapter "[Function keys and key combinations](#)", [Page 31](#) under "Display output, switch between".

Using fingers

You can use your finger on the touch screen of your device to execute commands and start applications.

Action	Description
Tapping	<ul style="list-style-type: none"> ▶ Tap on a symbol, menu, button or folder to select this option or to activate it.
Type, hold, release	<ul style="list-style-type: none"> ▶ Type and hold a symbol and release it again. The selected action is performed.
Dragging	<ul style="list-style-type: none"> ▶ Tap and hold a symbol and drag it to another place. <p>You can for instance drag apps or widgets onto the home page in this way.</p>
Double-tap	<ul style="list-style-type: none"> ▶ To enlarge a view, quickly tap twice on a web page, map or another screen. <p>When you double-tap on an image in a web browser, it will be enlarged and another double-tap will make it smaller again.</p>
Zoom in/Zoom out	<ul style="list-style-type: none"> ▶ With some apps, you can enlarge the display size by moving two fingers apart on the touchscreen, and reduce it by moving your fingers together.
Input fields	<p>Data must be entered for some apps, for instance an Internet page or your name and password.</p> <ul style="list-style-type: none"> ▶ Tap on the input field. <p>An on-screen keyboard opens, with which you can enter your data.</p>

WebCam and Infrared Camera



Depending on the device version, your device may have an integral Webcam with microphone.

Depending on the variant, the device contains an infrared camera instead of the webcam, enabling authentication with Microsoft Windows Hello.

Depending on the software used, you can use your Webcam to take pictures, record video clips or take part in web chats.

The WebCam has its own status indicator. The indicator lights up when the WebCam is switched on.

The webcam has a sliding shutter with which the camera can be covered.

- The picture quality depends on the lighting conditions and the software being used.
- You can only operate the webcam with a particular application (e.g. an Internet telephony program or a video conferencing program which supports a webcam).
- When using the webcam the notebook support must not wobble.
- The webcam automatically adjusts itself to the current light level. For this reason the LCD screen may flicker while the light level is adjusted.



Further information on using the webcam and on the additional settings which are possible for your webcam can be found in the help function of the program which uses the webcam.

ePrivacy Filter (optional)

If your monitor is equipped with the optional electronic privacy filter, you can activate and deactivate it by pressing the **[F9]** key. This can be used to restrict the possible side viewing angle for the monitor.

This feature can also be permanently enabled or disabled In the *BIOS setup utility* under *Advanced - Internal Device Configurations - ePrivacyFilter*. In this case it is no longer possible to switch the function on and off with the **[F9]** key.

Rechargeable battery

When not plugged into a mains socket, the notebook runs on its built-in battery. You can increase the life of the battery by caring for the battery properly. The average battery life is about 1000 charge/discharge cycles.

You can extend the battery life by taking advantage of the available energy saving functions.

Using *Battery Utility*, you can limit the max. charge to 80% instead of 100% capacity by configuring *Battery Charge Mode*. This will correspondingly reduce the potential battery life when discharging.

In particular, when you primarily use the laptop in one location with the mains adapter permanently connected, we recommend configuring *Battery Charge Mode* to 80% in order to extend the battery life.

If you require the maximum battery life for mobile use, we recommend configuring *Battery Charge Mode* to 100%.

You can find *Battery Utility* in the Windows start menu under *Settings - Extras* and online at "<https://support.ts.fujitsu.com/>"

Charging, caring for and maintaining the battery

The notebook's rechargeable battery can only be charged when the ambient temperature is between 5 °C / 41 °F and max. 35 °C / 95 °F.

If the battery is regularly charged at ambient temperatures above 25 °C, this may reduce the battery life.

You can charge the battery by connecting the notebook to the mains adapter (see "[Connecting the mains adapter](#)", [Page 23](#)).

Please note that the rechargeable battery will not be charged if its state of charge is between 90 % and 100 %. If the state of charge of the rechargeable battery is less than 90 % and the mains adapter is connected, the battery will be charged to 100 %.

When the battery state of charge is low, a message from the operating system appears. If you do not connect the mains adapter within about 5 minutes of the message appearing, your notebook will automatically switch off.

monitoring the battery charging level

Windows also has a "Battery status meter" in the taskbar for monitoring the battery capacity. When you place the mouse pointer on the battery symbol, the system displays the battery status.

Switch the battery off and on

Switch off the battery



You need the mains adapter to switch the battery on.

- ▶ Shut down the operating system (shut down).
 - ▶ Disconnect the device from the mains adapter and if applicable, from the Port Replicator as well.
 - ▶ Use a pencil or a wire (e.g. a paperclip) to press firmly into the opening of the off button for the battery, this will switch off the system.
- ↳ The device is currentless.

Switch on the battery

- ▶ Connect the device to the mains adapter of the notebook or to the Port Replicator.
- ▶ Switch the device on again.

Using the power-management features

The notebook uses less power when the available power-management features are used. You will then be able to work longer when using the battery before having to recharge it.



Power efficiency is increased and environmental pollution reduced. By choosing the best power options, you can make significant savings and at the same time help protect the environment.

When you close the LCD screen, depending on the setting in Windows, the notebook automatically enters a power saving mode.

- ▶ Select the power management functions in your Control Panel.



If you need further information about an option, you can get help about most settings by pressing the key combination **[Fn] + [F1]** to show the Microsoft help.

When the notebook is in power-saving mode, the following must be remembered:



During power-saving mode, open data is held in main memory or in a swap file on the file. Never turn off your notebook while it is in a power saving mode. If the built-in battery is nearly empty, close the open files and do not go into power saving mode.

If you do not intend to use your notebook for a long period of time:

- ▶ Exit power saving mode if necessary via the mouse or keyboard or by switching on the notebook.
- ▶ Close all opened programs and completely shut down the notebook.

Adjusting system performance in Microsoft Windows

Your system is supplied with an optimally adjusted balance between system performance, fan noise and battery life.

Windows 10: If required, you can change the system performance in mains operation or in battery operation separately by selecting the battery icon in the *Windows taskbar* with the *Windows Performance Power Slider*.

Windows 11: You can adjust the "Power Mode" after right-clicking on the battery icon in the corresponding menu.

- Maximum system performance increases fan noise and reduces battery life.
- Maximum battery life limits system performance.

Adjusting fan control

You can adjust the fan control in the BIOS Setup Utility. The following settings are available:

- *Normal*: The system is cooled to ensure that the maximum system performance is always available and to keep the housing temperature as low as possible.
- *Silent*: The fan rotation speed, and thereby the noise created by the fan, is reduced.

The default setting of this system is *Silent*.

- ▶ Call up the *BIOS Setup Utility*.
- ▶ In the menu *Advanced - Miscellaneous Configurations* select the *Fan Control* function.
- ▶ Choose the setting *Normal* or *Silent*.



Instructions for how to call up and operate the *BIOS-Setup-Utility* can be found in chapter ["Settings in BIOS Setup Utility", Page 66](#).



With the Fujitsu Utility *Function Manager* you can also switch between these two settings with Windows. In the *Function Manager*, select the *Fan* menu item with the options *Quiet Mode* (corresponds to *Silent*) and *Normal Mode*.

Memory cards

Your notebook is equipped with an integrated memory card reader.



Observe the manufacturer's instructions when handling the memory cards.

Supported format

Your notebook supports the following format:

- Secure Digital (microSD™ Card)

Inserting the memory card

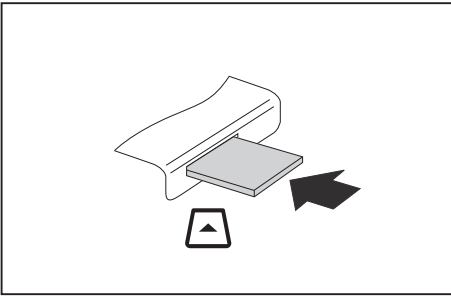

- ▶ Carefully push the memory card into the slot until you feel it click into place. The label area must be facing upward. Do not apply any force, otherwise the delicate contact surfaces could be damaged.
- ↳ Depending on the particular type used, the memory card may protrude slightly from the slot.

Removing the memory card



In order to protect your data, always follow the correct procedure for removing the card (see the documentation for your operating system).

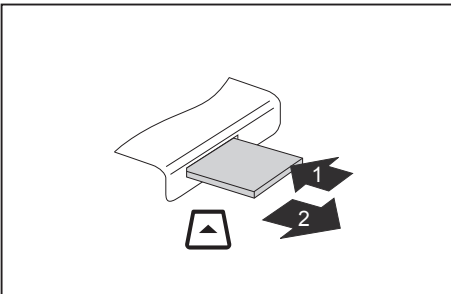

- ▶ On devices with card locking: Press on the memory card (1).
- ↳ The memory card is released and can now be removed.
- ▶ Pull the memory card out of the slot (2).

Loudspeakers and microphones

You will find information about the exact position of speakers and microphones in chapter ["Ports and controls", Page 9](#).

Please refer to chapter ["Function keys and key combinations", Page 31](#) for information on setting the volume and also enabling/disabling the loudspeakers via the keyboard.



If you attach an external microphone, the built-in microphone is disabled.

When you connect headphones or external speakers, the built-in speakers are disabled.

Information on connecting headphones and a microphone can be found in ["Connecting external devices", Page 59](#).

SIM card (configuration dependent)



The procedure is the same for all device variants.

All device variants support nano SIM cards.

A SIM Card (Subscriber Identity Module) is a chip card which is inserted in a mobile telephone or notebook and, together with an integrated LTE module, enables access to a mobile radio network.



Follow the instructions supplied by the provider of the SIM card.

Inserting the SIM card

- ▶ Switch off the battery so that the device is currentless (see ["Switch the battery off and on", Page 40](#)).

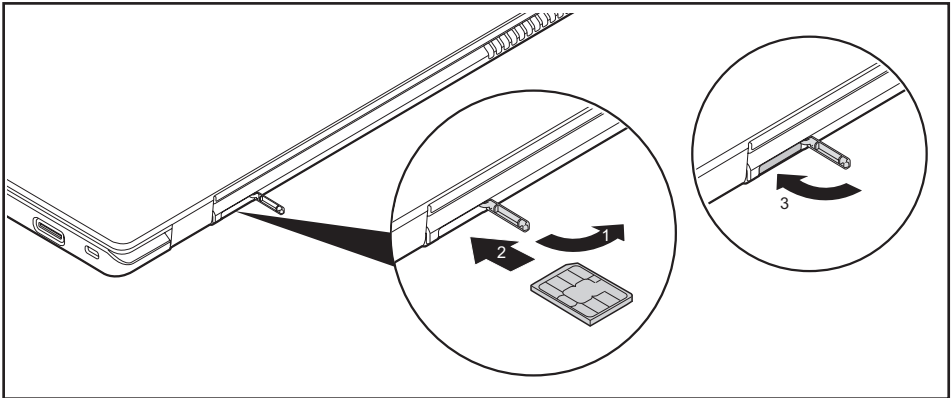

- ▶ Open the cover of the SIM card slot (1).
- ▶ Slide the SIM card into the slot (2) with the metal contacts facing upwards and as shown by the symbols next to the SIM card slot until it clicks into place.
- ▶ Close the cover of the SIM card slot (3).

Removing the SIM card

- ▶ Switch off the battery so that the device is currentless (see ["Switch the battery off and on", Page 40](#)).

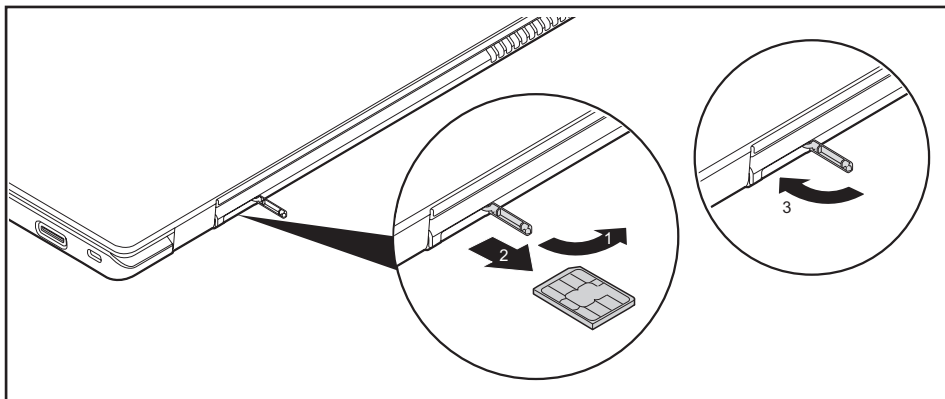

- ▶ Open the cover of the SIM card slot (1).
- ▶ Press on the edge of the SIM card so that it jumps up slightly out of the slot.
- ▶ Pull the SIM card out of its slot in the direction of the arrow (2).
- ▶ Close the cover of the SIM card slot (3).

Wireless components: wireless LAN / Bluetooth / LTE / 5G (optional)



The installation of radio components not approved by Fujitsu will invalidate the certifications issued for this device.

Switching the wireless components on and off

- ▶ Press the key with the radio symbol () to switch the wireless components on and off (flight mode).



If you disconnect the wireless components, the wireless LAN antennas and the Bluetooth and LTE or 5G modules are disconnected.

Pay attention to the additional safety notes for devices with wireless components provided in the "Safety/Regulations" manual.

You can obtain more information on LTE from your service provider.

Setting up WLAN access

- Requirement: A WLAN must be available and you must have the corresponding access information.



Information on configuring the WLAN access can be found in the documentation for your operating system.

Access via LTE / 5G (optional)



You can purchase the accessories for LTE reception from your retailer or your Fujitsu Technology Solutions dealer.

If you have ordered an LTE or 5G module, your device is already pre-set on delivery.

For information about connecting with the LTE or 5G network, please see the documentation for the hardware that you will be using.

Your device can connect with the Internet via the LTE module. To do this, use one of the following types of connection:

- USB dongle
 - a USB stick with your mobile phone provider's SIM card
- a mobile end-device (e.g. mobile phone) with Bluetooth connection
- a mobile end-device (e.g. mobile phone) with data cable

Ethernet and LAN

The internal network module of your notebook supports Ethernet LAN. You can use it to establish a connection to a local network (LAN = Local Area Network).



Your network administrator can help you to configure and use the LAN connections.

The network cable is not included in the delivery scope. This type of cable can be obtained from a specialist dealer.

Use a shielded network cable (CAT 5e).

FUJITSU LIFEBOOK U7312

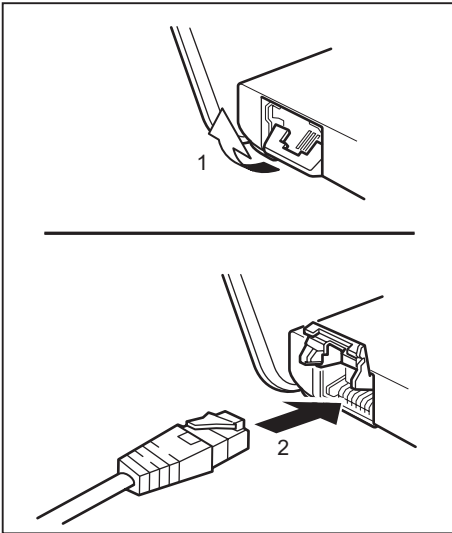

- ▶ Open the holder for the LAN connector (1).
- ▶ Connect the network cable to your LAN adapter (2).
- ▶ Connect the network cable to your network port.

FUJITSU LIFEBOOK U7412 / FUJITSU LIFEBOOK U7512

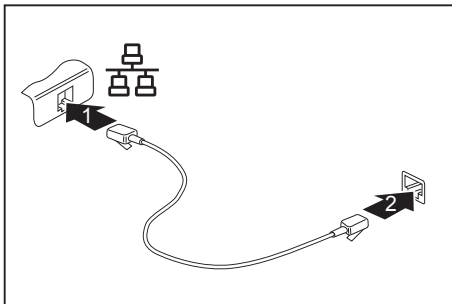

- ▶ Connect the network cable to the LAN port of the notebook (1).
- ▶ Connect the network cable to your network connection (2).

Your Port Replicator

The Port Replicator is a device that helps you to quickly connect your notebook to your peripheral devices, such as a monitor, printer etc.

The features offered by the Port Replicator include standard ports for monitor, audio, mouse and keyboard.

You need only dock the notebook in order to work with your peripheral devices.

i

In addition to the port replicator with mechanical docking described here, this system also supports optionally available USB Type-C or Thunderbolt port replicators that are connected to the system via the USB Type-C connector.

Ports on the Port Replicator

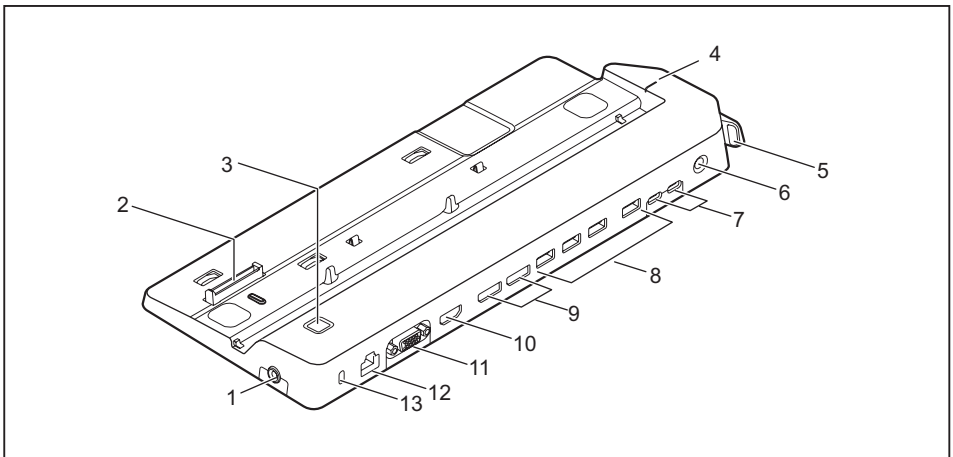

- | | |
|---|------------------------------------|
| 1 = Headset port | 8 = USB port 3.2 Gen1 (USB Type-A) |
| 2 = Connector on the Port Replicator for the docking port on the bottom of the notebook | 9 = Displayports |
| 3 = ON/OFF button | 10 = HDMI port |
| 4 = Mark for positioning the notebook | 11 = VGA monitor port |
| 5 = Unlocking lever | 12 = LAN port |
| 6 = DC jack socket (DC IN) | 13 = Security Lock device |
| 7 = USB port 3.2 Gen1 (USB Type-C) | |

Connecting the notebook to the Port Replicator



The suitable power adapter must be connected to the port replicator when the notebook is connected to the port replicator.

We recommend that the notebook is not operated with the LCD screen closed when the notebook is connected to the Port Replicator. The resulting overheating can cause reduced performance and increased activity of the integrated fan.

- ▶ If the power adapter cable is connected to the notebook, disconnect it from the Intel® Thunderbolt™ 4 USB Type-C port of the notebook.

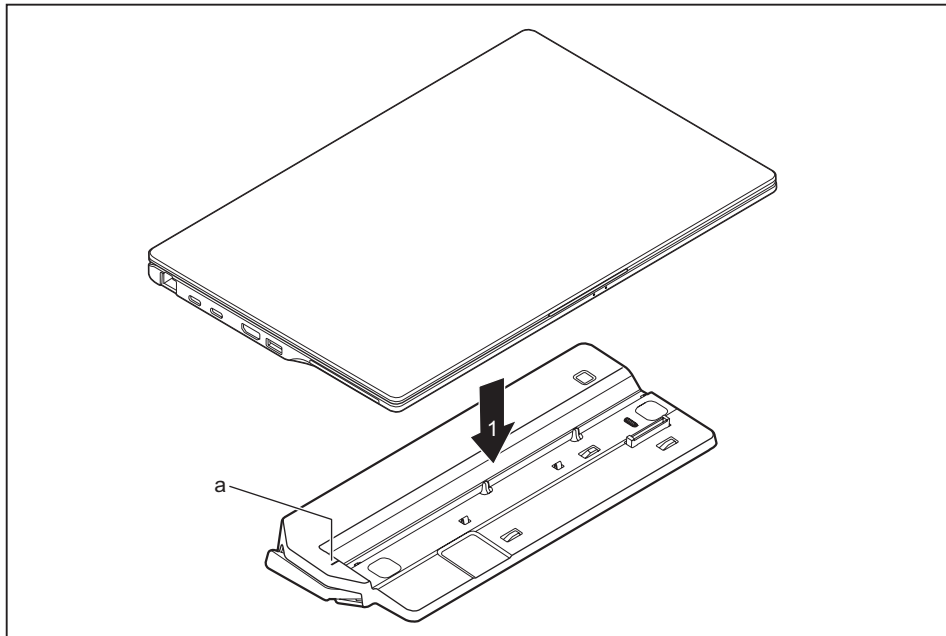

- ▶ Position the notebook so that the back edge is in line with the mark (a) of the port replicator.
- ▶ Place the notebook onto the Port Replicator (1) and ensure that it locks into place correctly.

Connecting the mains adapter to the Port Replicator

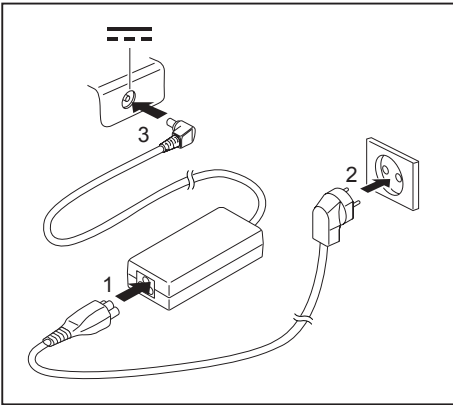

- ▶ Connect the power cable (1) to the power adapter provided for the device, see chapter "[Technical data](#)", [Page 79](#).
- ▶ Plug the power cable into the mains socket (2).
- ▶ Connect the mains adapter cable to the DC jack (DC IN) of the Port Replicator (3).



When the notebook is connected to a Port Replicator, the operating system creates a hardware profile for the "Docked" mode. In this profile, for example, the setting is saved as to which monitor was last used for output. This profile will be loaded, as soon as the notebook is connected to a Port Replicator of the same type.

Switching on the notebook via the port replicator

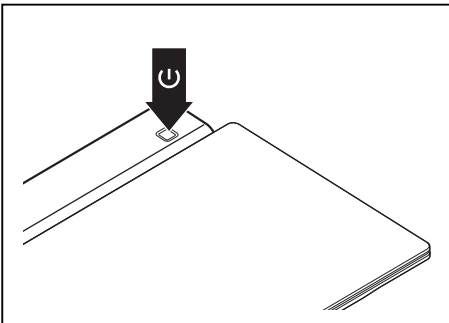

- ▶ Press the ON/OFF button on the port replicator to switch the notebook on.
- ↳ The power-on indicator of the Port Replicator lights up.

Disconnecting the notebook from the Port Replicator

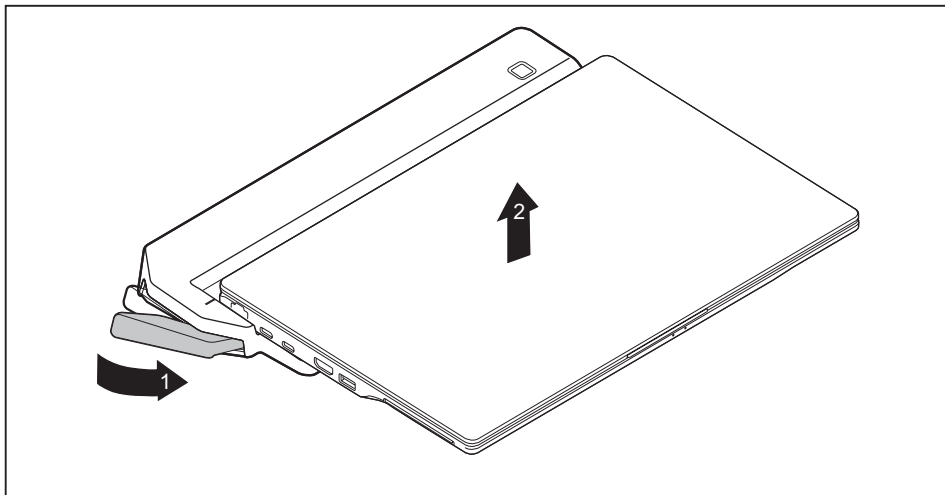

- ▶ Pull the unlocking lever in the direction of the arrow (1), until you hear the notebook unlatch.
- ▶ Lift off the notebook (2).

Security functions

Your notebook has several security features that you can use to secure your system from unauthorised access.

This chapter explains how to use each function, and what the benefits are.



Please remember that in some cases, for example, forgetting your password, you may be locked out and unable to access your data. Therefore, please note the following information:

- Make regular backups to external data carriers such as external hard drives, USB memory modules, DVDs or Blu-ray Discs.
- Some security functions need you to choose passwords. Make a note of the passwords and keep them in a safe place.

If you forget your passwords you will need to contact our Service Desk. Deletion or resetting of passwords is not covered by your warranty and a charge will be made for assistance.



If you change the *Password Severity* setting from *Strong* to *Stringent* in the *Security BIOS Setup Utility* menu, the Fujitsu Service Desk can no longer reset the password. In this case, the system can remain permanently unusable.

Therefore, Fujitsu recommends to generally set up a supervisor password with the setting *Password Severity = Strong*.

Configuring the fingerprint sensor



Whether or not your device has a fingerprint sensor depends on the device configuration you have ordered.

The fingerprint sensor can record an image of a fingerprint. With additional fingerprint software, this image can be processed and used instead of a password.

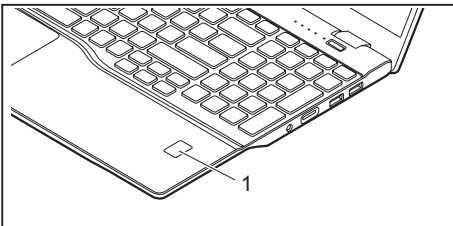

- ▶ You must install the fingerprint software in order to be able to use the fingerprint sensor (1).



The current *AuthConductor Client Basic* software for hand vein and fingerprint sensor is available on the Internet at ["https://support.ts.fujitsu.com/"](https://support.ts.fujitsu.com/)

After selecting the product and the operating system, you will find the software under *Downloads, Applications, Tools and Utilities*.

Configuring the palm vein sensor



Whether your device has a palm vein sensor depends on the device configuration you have ordered.

The palm vein sensor can record the image of the pattern of the veins of the hand. This image is evaluated by additional software and can be used instead of a password.

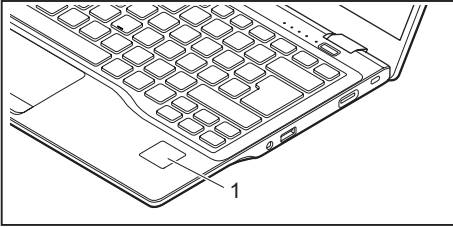

- ▶ To be able to use the palm vein sensor (1), you must install the software.



The current *AuthConductor Client Basic* software for hand vein and fingerprint sensor is available on the Internet at ["https://support.ts.fujitsu.com/"](https://support.ts.fujitsu.com/)

After selecting the product and the operating system, you will find the software under *Downloads, Applications, Tools and Utilities*.

Using the Security Lock

Your device comes with a Security Lock mechanism for the Kensington Lock Cable. You can use the Kensington Lock Cable, a sturdy steel cable, to help protect your notebook from theft. The Kensington Lock Cable is available as an accessory.



Fujitsu recommends the use of a combination lock.

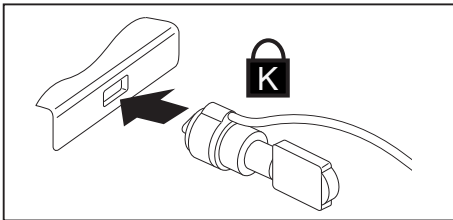

- ▶ Fit the Kensington Lock Cable to the mechanism on your notebook.



Attach another Kensington Lock Cable to your Port Replicator to protect your Port Replicator from theft as well.

Configuring password protection in BIOS Setup Utility



Before using the various options for password protection in the *BIOS Setup utility* to increase data security, please observe the following:

Make a note of the passwords and keep them in a safe place. If you forget your supervisor password you will not be able to access your notebook. Deletion of the password is not covered by your warranty and a charge will be made for assistance.



Your password can be up to 32 characters long and can contain letters, numbers and special characters.

When using special characters, you must remember that these are dependent on the country variants of the keyboard used.



If you change the *Password Severity* setting from *Strong* to *Stringent* in the *Security BIOS Setup Utility* menu, the Fujitsu Service Desk can no longer reset the password. In this case, the system can remain permanently unusable.

Therefore, Fujitsu recommends to generally set up a supervisor password with the setting *Password Severity* = *Strong*.

Protecting BIOS Setup Utility (supervisor and user password)



If you have opened these operating instructions on the screen, we recommend that you print them out. You cannot call the instructions onto the screen while you are setting up the password.

The supervisor password and the user password both prevent unauthorised use of the *BIOS Setup Utility*. With the aid of the supervisor password you can access all of the functions of the *BIOS Setup Utility*, while the user password will only give you access to some of the functions. You can only set up a user password if a supervisor password has already been assigned.



Please refer to section ["Settings in BIOS Setup Utility", Page 66](#) for a description of how to call up and operate the *BIOS-Setup-Utility*.

Assigning the supervisor and user passwords

- ▶ Start the *BIOS Setup Utility* and go to the *Security* menu.
- ▶ Select the *Set Supervisor Password* field and press the Enter key.
- ↳ With *Enter new Password*: you are asked to enter a password.
- ▶ Enter the password and press the Enter key.
- ↳ *Confirm new Password* requires you to confirm the password.
- ▶ Enter the password again and press the Enter key.
- ↳ *Changes have been saved* is a confirmation that the new password has been saved.
- ▶ To set the user password, select *Set User Password* and proceed exactly as when configuring the supervisor password.
- ↳ If you do not want to change any other settings, you can exit *BIOS Setup Utility*.
- ▶ In the *Exit* menu, select the option *Save Changes & Exit*.
- ▶ Select *Yes* and press the Enter key.
- ↳ The notebook is then rebooted and the new password comes into effect. It will now be necessary to first enter your supervisor or user password in order to open the *BIOS Setup Utility*. Please note that the user password only provides access to a few of the BIOS settings.

Changing the supervisor or user password

You can only change the supervisor password when you have logged into the *BIOS Setup Utility* with the supervisor password.

- ▶ Call the *BIOS Setup Utility* and go to the *Security* menu.
- ▶ When changing the password, proceed exactly as for password assignment.

Removing passwords

To remove a password (without setting a new password) perform the following steps:

- ▶ Start the *BIOS Setup Utility* and go to the *Security* menu.
- ▶ Highlight the *Set Supervisor Password* or *Set User Password* field and press the Enter key.
- ↳ You will be requested to enter the current password by the *Enter Current Password* prompt. You will be requested to enter a new password by the *Enter New Password* prompt.
- ▶ Press the Enter key twice.
- ▶ In the *Exit* menu, select the option *Save Changes & Exit*.
- ▶ Select *Yes* and press the Enter key.
- ↳ The notebook will now reboot with the password removed.
Removing the supervisor password simultaneously deactivates the user password.

Password protection for booting of the operating system



With the supervisor password you have set in the *BIOS Setup Utility* (see section ["Assigning the supervisor and user passwords", Page 56](#)), you can also prevent starting of the operating system.

Activating system protection

- ▶ Start the *BIOS Setup Utility* and go to the *Security* menu.
- ▶ Select the *Password on Boot* option and press the Enter key.
- ▶ Select the desired option (*Disabled*, *First Boot* or *Every Boot*) and press the Enter key
- ▶ Select the *Save Changes & Exit* option under *Exit*.
- ↳ The notebook reboots. You will be prompted to enter your password (the supervisor password).

Deactivating system protection

- ▶ Start the *BIOS Setup Utility* and go to the *Security* menu.
- ▶ Select the *Password on Boot* option and press the Enter key.
- ▶ Select the *Disabled* option and press the Enter key.
- ↳ If you do not want to change any other settings, you can exit *BIOS Setup Utility*.
- ▶ Select the *Save Changes & Exit* option under *Exit*.
- ↳ The notebook will reboot. The system is no longer password-protected.

Password protection for the drive

If a supervisor password has been assigned, a password for the drive can also be set in the *Hard Disk Security* menu.

The drive is protected by this password. Data from this drive can only be read into another system if the correct password has been entered.

SmartCard reader



Depending on the device configuration, your notebook may be equipped with a SmartCard reader.

SmartCards are not supplied as standard equipment. You can use all SmartCards that comply with the ISO standard 7816-1, -2 or -3. These SmartCards are available from various manufacturers.

With the appropriate software you can use your SmartCard as an alternative to password protection, but also as a digital signature, for encrypting your e-mails or for home banking.

We recommend that you always use two SmartCards. Always keep one of the SmartCards in a safe place if you are carrying the other SmartCard with you.

In order to be able to take advantage of all the security features of your notebook, you will need a CardOS SmartCard.



The SmartCard can only be used with a PIN, offering maximum protection even if you lose the SmartCard. In order to maximise your security, the CardOS SmartCard is disabled if three incorrect attempts are made to enter the PIN.

When you use the CardOS SmartCard for the first time, you will either need to enter the preset PIN "12345678" or the PIN given to you by your systems administrator.

Inserting the SmartCard



Do not use force when inserting and removing the SmartCard.

Make sure that foreign objects do not fall into the SmartCard reader.

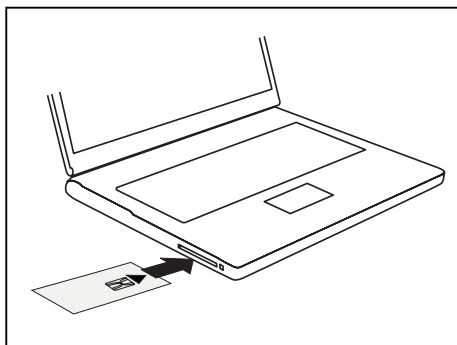

- ▶ Slide the SmartCard into the SmartCard reader with the chip facing upwards (on some variants it faces down) and to the front.

Connecting external devices



Always refer to the safety information provided in ["Important notes", Page 18](#) before connecting or disconnecting any devices to or from your notebook.

Always read the documentation supplied with the device you wish to connect.

Never connect or disconnect cables during a thunderstorm.

Never pull at a cable when disconnecting it. Always grasp the plug.



With some devices such as USB devices, it is not necessary to switch off the notebook and the device before connecting/disconnecting. For more information about whether or not devices need to be switched off, please refer to the documentation supplied with the external device.

Some of the external devices require special drivers (see the operating system and external device documentation).

Connecting an external monitor

An analogue screen is connected to the analogue VGA screen port and a digital screen to the display port or HDMI port on the optional port replicator.

The HDMI port on your notebook or the optional port replicator can also be used to connect an external amplifier, LCD TV or a plasma TV with an HDMI connection.

Screen output is limited to a maximum of three screens at the same time (see ["Function keys and key combinations", Page 31](#), section "Toggling the screen output").

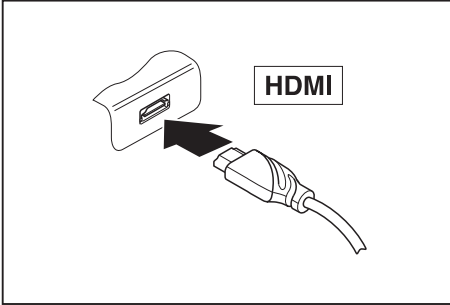

Digital HDMI port (on LIFEBOOK or optional port replicator)

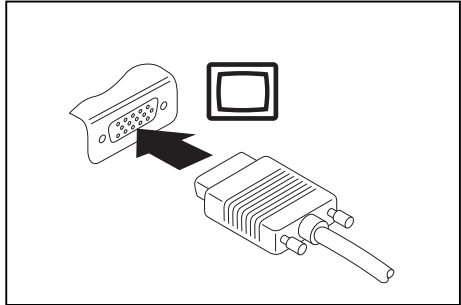

Analogue VGA monitor port (on optional port replicator)

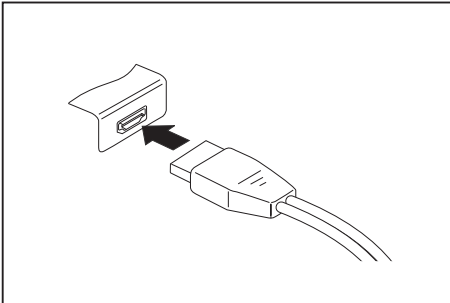

Digital display port (on the optional port replicator)

- ▶ Switch off the notebook and the external monitor.
- ▶ Plug the data cable of the external monitor into the monitor port.
- ▶ First switch on the external monitor and then the notebook.



You can also switch between the external monitor and the LCD monitor of the notebook, see chapter ["Function keys and key combinations", Page 31](#).

You can display the same picture on the external monitor and the notebook LCD monitor simultaneously.

Connecting USB devices

On the USB ports, you can connect external devices that also have a USB port (e.g. a DVD drive, a printer, a scanner or a modem).



USB devices are hot-pluggable. This means you can connect and disconnect devices while your operating system is running.

USB 1.x has a maximum data transfer rate of 12 Mbit/s.

USB 2.0 has a data transfer rate of up to 480 Mbit/s.

USB 3.0 has a data transfer rate of up to 5 Gbit/s.

USB 3.2 (Gen1) has a data transfer rate of up to 5 Gbit/s.

USB 3.2 (Gen2) has a data transfer rate of up to 10 Gbit/s.

Additional information can be found in the documentation for the USB devices.

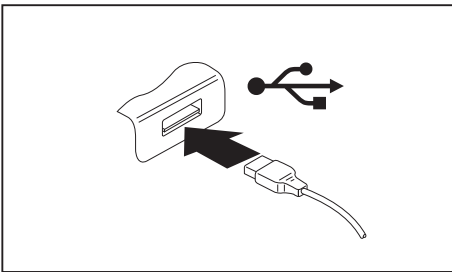

- ▶ Connect the data cable to the external device.
- ▶ Connect the data cable to a USB port of the notebook.



Device drivers

USB devices will be automatically recognised and installed by your operating system.

USB port Intel® Thunderbolt™ 4 with charging function and display port (USB Type-C)

At this USB port, you can charge a connected USB device or operate devices without additional power supply.

This is also possible with connected notebook computers by going to the *BIOS Setup Utility* under the menu *Advanced > Miscellaneous Configurations* and activating the function *USB Type-C Power Delivery on System-Off*. Instructions for how to call up and operate the *BIOS Setup Utility* can be found in section ["Settings in BIOS Setup Utility", Page 66](#).

With the USB Type-C Port Replicator available as an accessory, the notebook can be supplied with power via this USB port.



USB devices are hot-pluggable. This means you can connect and disconnect the cables of USB devices while the system is running.

Additional information can be found in the documentation for the USB devices.

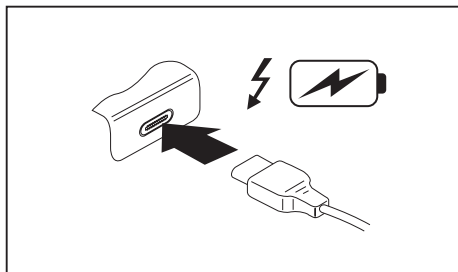

- ▶ Connect the data cable to the external device.
- ▶ Connect the data cable to the USB port Intel® Thunderbolt™ 4 with charging function and display port (USB Type-C) of the notebook.

USB port with charging function (Anytime USB charge)

You can use this USB port to charge or supply power to a connected USB device (e.g. to charge a PDA or a mobile phone or to connect a USB lamp).

Charging is also possible when the notebook is switched off, if the *Anytime USB Charge* function is activated in the *Advanced* menu of the *BIOS Setup Utility*. If the setting *AC* is selected, the device will only be charged when the mains adapter is connected.

Please refer to section "[Settings in BIOS Setup Utility](#)", [Page 66](#) for a description of how to call up and operate the *BIOS-Setup-Utility*.



It is recommended that the notebook be operated with the power supply connected whenever the USB port with charging function is in use, as this function will drain the battery more quickly if an external USB device is being charged.

The power supply unit must already be connected when the notebook is switched off, as otherwise the USB charging function will be disabled and the connected USB devices will not be charged.



Some USB devices (e.g. mobile telephones) require a driver in order to utilise the USB charging function. In this case the USB charging function will not work when the notebook is switched off, as no drivers are active when the notebook is switched off.

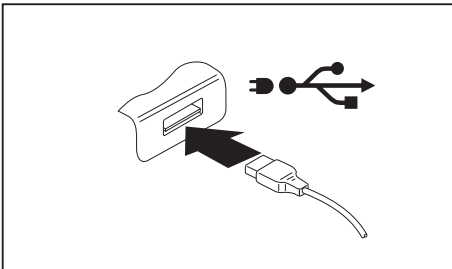

- ▶ Connect the data cable to the external device.
- ▶ Connect the data cable to a USB port (Anytime USB charge) of the notebook.

How to remove USB devices correctly



Always correctly remove the device according to the rules described below, to ensure that none of your data is lost.

- ▶ Left click on the icon to safely remove hardware, located in the taskbar.
- ▶ Select the device which you want to shut down and remove.
- ▶ Press the Enter key.
- ↳ Wait for the dialogue box which tells you that it is now safe to remove the device.

Headset port

The headset port lets you connect a headset, headphones, external speakers or microphones to your notebook.

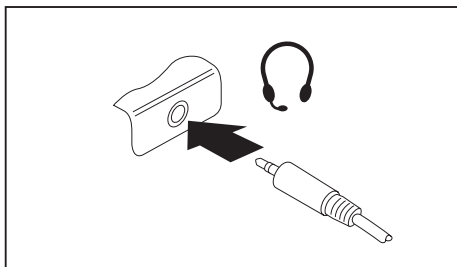

- ▶ Connect the audio cable to the external device.
- ▶ Connect the audio cable to the headset port of the notebook.
- ↳ The internal loudspeakers are disabled.



If you buy a cable from a retailer, please note the following information:

The headset port on your notebook is a "3.5 mm jack socket".

If you want to connect a headset, headphones or loudspeakers, you will need a "3.5 mm jack plug".

Removing and installing components during servicing



Only qualified technicians should repair your notebook. Unauthorised opening or incorrect repair may greatly endanger the user (electric shock, fire risk) and will invalidate your warranty.

After consulting the Hotline/Service desk, you may remove and install certain components described in the separate manual "LIFEBOOK U7312 / U7412 / U7512 System Upgrades and Repairs" yourself.

Please note that the majority of pages in the manual are marked "Service Partner only"; this means that you must not remove those components yourself. The instruction manual can be found at: ["http://support.ts.fujitsu.com/download"](http://support.ts.fujitsu.com/download).



Removing and installing components without consulting the Hotline/Service desk will invalidate the warranty for your notebook.

Settings in BIOS Setup Utility

The *BIOS Setup Utility* allows you to set the system functions and the hardware configuration for the notebook.

When it is delivered, the notebook is set to factory default settings. You can change these settings in *BIOS Setup Utility*. Any changes you make take effect as soon as you save and exit the *BIOS Setup Utility*.

The *BIOS Setup Utility* program contains the following menus:

<i>Info</i>	Displays information relating to the BIOS, processor and notebook
<i>System</i>	Advanced system settings
<i>Advanced</i>	Configuring various hardware parts such as USB ports, keyboards, processors
<i>Security</i>	Password settings and security functions
<i>Boot</i>	Configuration of the start-up sequence
<i>Exit</i>	Exits the <i>BIOS Setup Utility</i>

Starting the BIOS Setup Utility

- ▶ Start the device (switch off/on or reboot the Operating System).
- ▶ When switching on your device, press on function key **F2** until the *BIOS-Setup-Utility* is displayed.
- ▶ If a password has been assigned, enter the password and press the Enter key.



If you have forgotten the password, contact your system administrator or contact our customer service centre.

The *BIOS Setup Utility* starts.



Instead of pressing function key **F2**, if you press function key **F12** when switching on your device, a boot menu with options will appear. You can use this to start the system, also via other data sources, e.g. via a network.

You can also access the *BIOS-Setup-Utility* from the boot menu with the tab key.

Operating the BIOS Setup Utility



Press the **F1** key to display help on the operation of the *BIOS Setup Utility*. The description of the individual settings is shown in the right-hand window of the *BIOS Setup Utility*.

With the **F9** key you can load the default settings of the *BIOS Setup Utility*.

- ▶ Use the cursor keys **←** or **→** to select the menu in which you would like to configure settings.
↳ The menu is displayed on the screen.
- ▶ Select the option that you want to change with the cursor keys **↑** or **↓**.
- ▶ Press the Enter key.
- ▶ Press the **ESC** key to exit the selected menu.
- ▶ For future reference, make a note of the changes you have made (e.g. in this manual).

Exiting BIOS Setup Utility

You need to select the desired option in the *Exit* menu and activate it by pressing the Enter key:

Exit Saving Changes - save changes and exit BIOS Setup Utility

- ▶ To save the current menu settings and exit the *BIOS Setup Utility*, select *Exit Saving Changes* and *Yes*.
- ↳ The notebook is rebooted and the new settings come into effect.

Exit Discarding Changes – Discard changes and exit BIOS Setup Utility

- ▶ To discard the changes, select *Exit Discarding Changes* and *Yes*.
- ↳ The settings in place when *BIOS Setup Utility* was called remain effective. *BIOS Setup Utility* is terminated and the notebook is rebooted.

Load Setup Defaults – Copy Standard Entries

- ▶ To copy the standard entries for all menus of the *BIOS Setup Utility*, choose *Load Setup Defaults* and *Yes*.

Discard Changes – Discard changes without exiting the BIOS Setup Utility

- ▶ To discard the changes you have made, select *Discard Changes* and *Yes*.
- ↳ The settings in place when *BIOS Setup Utility* was called remain effective. You can now make additional settings in the *BIOS Setup Utility*.
- ▶ If you want to exit *BIOS Setup Utility* with these settings, select *Exit Saving Changes* and *Yes*.

Save Changes - save changes without exiting the BIOS Setup Utility

- ▶ To save the changes, select *Save Changes* and *Yes*.
- ↳ The changes are saved. You can now make additional settings in the BIOS Setup Utility.
- ▶ If you want to exit BIOS Setup Utility with these settings, choose *Exit Saving Changes* and *Yes*.

Save Changes and Power Off

- ▶ To save the changes and switch off your device, select *Save Changes and Power Off* and *Yes*.
- ↳ The changes are saved. Your device is shut down.

Erase Disk

Erase Disk is a solution that is integrated into the firmware of the FUJITSU Computer (UEFI: Unified Extensible Firmware Interface), to delete all the data from a hard disk or a solid state drive (SSD) memory module.

This function can be used to permanently delete all data from hard disks or SSD memory modules, before they are discarded or the complete computer system is disposed of. The function can also be used if hard disks/SSD memory modules must be completely deleted, e.g. before installing a new operating system.



The application can only be selected and run if an administrator/supervisor password has been assigned (Menu *BIOS Setup - Security*).

Proceed as follows to delete data from hard disks/SSD memory modules:

- ▶ Call the *BIOS Setup* with the Administrator/Supervisor password.
- ▶ To start the application, select *Erase Disk (BIOS Setup - Advanced or BIOS Setup - Security)* and set *Start after Reboot*.
- ▶ Then select *Save Changes and Exit* in the menu *Save & Exit / Exit* to initiate a reboot and start *Erase Disk*.



Because of the reboot, the *Erase Disk* will be started. You have the option to interrupt the process during the user selection.

- ▶ After the application starts, the Administrator/Supervisor password must be entered for security reasons.
- ↳ A dialogue field appears in which a particular, several or all the hard disks/memory modules can be selected for deletion. This depends on the number of hard disks/SSD storage modules in your system.
- ▶ Select the hard disk(s)/SSD memory modules to be deleted. The selected hard disk(s)/SSD memory modules will be deleted one-by-one.



Erase Disk offers four deletion options, from *fast* (with one deletion pass) to *very secure* (with 35 deletion passes). Depending on the algorithm chosen, the process can take between ~10 seconds and ~10 minutes per GB:

- *Zero Pattern* (1 pass)
- *German BSI/VSITR* (7 passes)
- *DoD 5220.22-M ECE* (7 passes)
- *Guttmann* (35 passes)



SSD drives are securely erased with the *Enhanced Secure Erase ATA* command integrated in the firmware.

- ▶ Select the desired deletion algorithm for the selected hard disks/SSD memory modules.



The complete deletion process can be recorded as an audit-compliant log and copied to an external USB stick, which must be formatted as FAT32. Please connect only one external USB stick.

- ▶ Select whether a status report should be written to the USB stick.



The user can select the following tasks which should be run by the system after the deletion process:

- *Reset administrator and user password*
- *Load BIOS setup defaults*
- *Shutdown the Computer*
- *Exit Erase Disk with no additional options upon completion*

- ▶ Select the function which you require.

↳ The deletion process starts.

Troubleshooting and tips



Follow the safety notes in the "Safety/Regulations" manual when connecting or disconnecting cables.

If a fault occurs, try to correct it as described. If you fail to correct the problem, proceed as follows:

- ▶ Make a note of the steps and the circumstances that led to the fault. Also make a note of any error messages displayed.
- ▶ Switch the notebook off.
- ▶ Please contact the Hotline/Service Desk.



The telephone numbers can be found at: ["http://support.ts.fujitsu.com/contact/servicedesk"](http://support.ts.fujitsu.com/contact/servicedesk). Have the following information ready when you call:

- The model name and serial number of the notebook. The serial number is located on a sticker on the underside of the notebook.
- Notes of any messages that appear on the screen and information on acoustic signals.
- Any changes you have made to the hardware or software since receiving the notebook.
- Any changes you have made to the *BIOS Setup* settings since receiving the notebook.
- Your system configuration and all peripheral devices connected to your system.
- Your sales contract.



Our notebooks have been designed primarily with mobile applications in mind. This means that considerable effort has been made to optimise components and equipment in terms of weight, space and energy requirements. Depending on the particular configuration you have purchased, it is possible that functionality may be slightly reduced compared to a desktop PC if you are running processor-intensive gaming software, e.g. games with intensive 3D graphics. Updating your hardware with drivers which have not been approved by Fujitsu Technology Solutions may result in performance losses, data losses or malfunction of the equipment. A list of approved drivers and current BIOS versions can be downloaded from: ["http://support.ts.fujitsu.com/Download/Index.asp"](http://support.ts.fujitsu.com/Download/Index.asp)

Help if problems occur

Should you encounter a problem with your computer that you cannot resolve yourself:

- ▶ Note the ID number of your device. The ID number is found on the type rating plate on the back or underside of the casing.
- ▶ Contact the Service Desk responsible for your country for clarification of the problem: ["http://support.ts.fujitsu.com/contact/servicedesk"](http://support.ts.fujitsu.com/contact/servicedesk). When you do this, please have ready the ID number and serial number of your system.

Recovering drive contents from the Recovery DVD

You can use the "Windows Recovery DVD" (optionally available) and the "Drivers & Utilities" DVD to reinstall the operating system.

The instructions are provided on the case of the Recovery DVD.



You will need an external optical drive available as an accessory.



During the reinstall process your personal files and any installed programs will be deleted. We advise you to backup your files to an external hard drive or DVD disk before you start.

- ▶ Switch the notebook on.
- ▶ Press function key **[F12]**.
- ▶ Insert the "Windows Recovery DVD" into the optical drive.
- ▶ Select the DVD drive and press the Enter key.
- ▶ Follow the instructions on the screen.

After the installation you must install all the drivers again. Some installed hardware components will not be correctly supported until this has been done.

- ▶ Insert the "Drivers & Utilities" DVD into the optical drive. The DVD starts automatically.
- ▶ Click on the *Desk Update* button.
- ▶ Select *Automatic driver installation (Express)* and click on *Start installation*.
- ▶ Follow the instructions on the screen.
- ▶ Restart your notebook when the driver installation is completed.

Restoring the system under Windows

If necessary, you can reset your system to the original state of the drive.

- ▶ Select *Settings* from the Start menu.
 - ▶ Select your *system*.
 - ▶ Select *Recovery*.
 - ▶ Select *Reset this PC*.
- ↳ The system will be reset.

The notebook's date or time is incorrect

Cause	Troubleshooting
Time and date are incorrect.	▶ With the <i>BIOS-Setup-Utility</i> , you can set the date and time in the <i>main</i> menu.
If the time and date are still set incorrectly after switching on the notebook.	▶ Please contact your sales outlet or our Hotline/Service Desk.

When certain characters are entered on the keyboard, only numerals are written

Cause	Troubleshooting
The virtual numeric keypad of your device is activated, see "Virtual numeric keypad", Page 30	▶ Press the [Num] key.

The notebook's LCD screen remains blank

Cause	Troubleshooting
Monitor is switched off.	▶ Press a key or touch the touchpad.
External monitor or television set connected.	▶ Press the key combination to switch the screen output, see "Function keys and key combinations", Page 31 .

The LCD screen is difficult to read

Cause	Troubleshooting
Reflected glare	▶ Turn the notebook or alter the tilt of the LCD screen. ▶ Increase the brightness of the screen.

The external monitor remains blank

Cause	Troubleshooting
Monitor is switched off.	▶ Switch the external monitor on.
Power saving has been activated (monitor is blank).	▶ Press any key to continue.
Brightness is set to dark.	▶ Adjust the brightness of the monitor.
Screen output is set to the notebook's LCD screen	▶ Press the key combination to switch the screen output, see "Function keys and key combinations", Page 31 .
The external monitor's power cable or data cable is not connected properly.	▶ Switch off the external monitor and the notebook. ▶ Check whether the power cable is plugged properly into the external monitor and into the power socket. ▶ Check whether the data cable is properly connected to the notebook and the external monitor (if it is plugged in with a connector). ▶ Switch on the external monitor and the notebook.

The external monitor is blank or the image is unstable

Cause	Troubleshooting
<p>The wrong external monitor has been selected or the wrong screen resolution has been set for the application program.</p>	<ul style="list-style-type: none"> ▶ Terminate the application program in Windows by pressing [Alt] + [F4]. If the fault persists after closing the program, use the key combination for switching the screen output (see "Function keys and key combinations", Page 31) to switch over to the notebook's LCD screen. Change the following setting: ▶ Set the screen resolution: Set the screen resolution as described in the documentation for your operating system. ▶ Select monitor: Select monitor 1 or 2 as described in the documentation for your operating system.

The notebook cannot be started

Cause	Troubleshooting
<p>The battery is dead.</p>	<ul style="list-style-type: none"> ▶ Charge the battery. <p>or</p> <ul style="list-style-type: none"> ▶ Connect the mains adapter to the notebook.
<p>The power adapter is not connected correctly.</p>	<ul style="list-style-type: none"> ▶ Check whether the mains adapter is connected correctly to the notebook. ▶ Switch the notebook on.

The notebook stops working

Cause	Troubleshooting
<p>Notebook is in energy saving mode.</p>	<ul style="list-style-type: none"> ▶ Leave energy saving mode.
<p>An application programme has caused the malfunction.</p>	<ul style="list-style-type: none"> ▶ Close the application program or restart the notebook (by restarting the operating system or switching the device off and back on again).
<p>The battery is dead.</p>	<ul style="list-style-type: none"> ▶ Charge the battery. <p>or</p> <ul style="list-style-type: none"> ▶ Insert a charged battery. <p>or</p> <ul style="list-style-type: none"> ▶ Connect the mains adapter to the notebook.

The printer does not print

Cause	Troubleshooting
The printer is not switched on.	<ul style="list-style-type: none"> ▶ Make sure that the printer is switched on and ready for operation (refer to the documentation supplied with the printer).
The printer is not connected correctly.	<ul style="list-style-type: none"> ▶ Check that the data cable connecting the notebook to the printer is properly connected.
The printer driver is faulty or not correctly installed, or it is the wrong printer driver.	<ul style="list-style-type: none"> ▶ Check that the data cable connecting the notebook to the printer is properly connected. ▶ Check whether the correct printer driver is loaded (refer to the printer documentation).

The wireless connection to a network does not work

Cause	Troubleshooting
The wireless component is disabled.	<ul style="list-style-type: none"> ▶ Switch the wireless component on (see "Switching the wireless components on and off", Page 47).
The wireless component is enabled. Despite this, the wireless connection to a network does not work.	<ul style="list-style-type: none"> ▶ Check whether the wireless connection is switched on via the software. ▶ Further information on using the wireless component can be found in the help files.

SmartCard reader is not recognised.

Cause	Troubleshooting
Chip card inserted incorrectly.	<ul style="list-style-type: none"> ▶ Check if you inserted your SmartCard into the SmartCard reader correctly. ▶ Check whether the SmartCard you are using is supported. Your SmartCard must comply with the ISO standard 7816-1, -2, -3 and -4.

SmartCard PIN forgotten

Cause	Troubleshooting
PIN forgotten	<ul style="list-style-type: none"> ▶ If you are working in a network, contact your system administrator, who can unlock your notebook with a Supervisor PIN.

SmartCard lost

Cause	Troubleshooting
SmartCard lost	▶ If you are working in a network, contact your system administrator, who can boot up your notebook with a Supervisor SmartCard.

Error messages on the screen

This section describes the error messages generated by the BIOS Setup. Error messages displayed by the operating system or programmes are described in the relevant documentation.



If the error message appears repeatedly, despite troubleshooting measures, please contact the place of purchase or our customer service centre.

Error message/cause	Resolution
<p><i>CMOS battery bad</i></p> <p>If the error message occurs repeatedly, the buffer battery in the notebook is flat.</p>	<ul style="list-style-type: none"> ▶ Contact your sales outlet or our customer service centre.
<p><i>System CMOS checksum bad - Default configuration used</i></p> <p>The system configuration information is incorrect.</p>	<ul style="list-style-type: none"> ▶ Switch the notebook off. ▶ Switch the notebook on. ▶ Press the function key [F2] to access the <i>BIOS Setup</i>. ▶ In the <i>BIOS Setup</i>, select the <i>Exit</i> menu. ▶ Select the entry <i>Load Setup Defaults</i>. ▶ Select <i>OK</i> and press the Enter key.
<p><i>Extended memory failed at offset: xxxx Failing Bits: zzzz zzzz</i></p> <p>When testing the extended memory an error has resulted at the address xxxx.</p>	<ul style="list-style-type: none"> ▶ Check whether the additional memory module has been inserted correctly.
<p><i>Failure Fixed Disk n</i></p> <p>The drive settings are incorrect.</p>	<ul style="list-style-type: none"> ▶ Start the <i>BIOS Setup (Primary Master submenu)</i> and select the correct settings.
<p><i>Keyboard controller error</i></p>	<ul style="list-style-type: none"> ▶ Switch the notebook off using with the ON/OFF button. ▶ Wait 3 - 5 seconds and switch on the notebook again.
<p><i>Keyboard error</i></p>	<p>If you are using an external keyboard:</p> <ul style="list-style-type: none"> ▶ Check the connection and reboot the notebook.
<p><i>nn Stuck key</i></p>	<ul style="list-style-type: none"> ▶ Make sure that no key is pressed.
<p><i>Operating system not found</i></p>	<ul style="list-style-type: none"> ▶ Check whether your drive has been correctly configured in the <i>BIOS Setup</i>. ▶ Make sure that the operating system is installed on the corresponding drive.
<p><i>Press <F1> to resume, <F2> to SETUP</i></p> <p>This error message appears if an error occurs during the self-test before starting the operating system.</p>	<ul style="list-style-type: none"> ▶ Press the [F1] function key to start the operating system. ▶ Press the function key [F2] to access the <i>BIOS Setup</i>.

Error message/cause	Resolution
<i>Previous boot incomplete - Default configuration used</i> Due to an error during the previous system boot, default values were used for certain settings. Check the settings in the BIOS Setup.	▶ Press the <input type="text" value="F1"/> function key when prompted to do so.
<i>Real time clock error</i>	▶ Contact your sales outlet or our customer service centre.
<i>nnnnK Shadow RAM failed at offset: xxxx Failing Bits: zzzz</i>	▶ Contact your sales outlet or our customer service centre.
<i>System battery is dead - Replace and run SETUP</i>	▶ Contact your sales outlet or our customer service centre.
<i>System cache error - Cache disabled</i>	▶ Contact your sales outlet or our customer service centre.
<i>System timer error</i>	▶ Contact your sales outlet or our customer service centre.

Technical data

LIFEBOOK

	LIFEBOOK U7312	LIFEBOOK U7412	LIFEBOOK U7512
Ambient conditions			
Operating temperature	5 °C 35 °C / 41 °F 95 °F		
Temperature in transit	-10 °C 60 °C / 14 °F 140 °F		
Relative humidity	20 % ... 80 % (no condensation)		
Operating height	up to 3048 m		
Dimensions			
Width x depth x height	308 mm x 199,5 mm x 18,9 mm / 12,13" x 7,85" x 0,74"	322 mm x 211 mm x 18,9 mm / 12,68" x 8,31" x 0,74"	357 mm x 230 mm x 19,1 mm / 14,06" x 9,06" x 0,75"
Weight	from 0.99 kg / 2,18 lbs	from 1.13 kg / 2,49 lbs	from 1.37 kg / 3,02 lbs
Main memory			
Slots	2 slots 260-pin DDR4 – 3200 SO-DIMM with a total of max. 64 GB		
Approved memory modules	4 GByte, 8 GByte, 16 GByte or 32 GByte DDR4 - 3200 MHz SO-DIMM		



The data sheet for the device provides further technical data. You will find the data sheet on your device or on the Internet at ["http://www.fujitsu.com/fts/support/"](http://www.fujitsu.com/fts/support/).

Rechargeable battery



CAUTION!

Risk of explosion if the battery is replaced with an incorrect battery type.



You can find information on the batteries used in your device on the Internet at ["http://www.fujitsu.com/fts/support/"](http://www.fujitsu.com/fts/support/).

	4-cell battery 65 Wh for U7512	4-cell battery 60 Wh for U7312 and U7412
Rated voltage	15.12 V	15.44 V
Rated capacity	4280 mAh	3915 mAh
Type	Lithium ions	
Interchangeability	Fujitsu Technology Solutions recommends that you let an authorised service provider take care of the replacement.	

	Battery Button Cell CR2032
Type	Lithium metal
Interchangeability	By authorized service provider

Mains adapter (notebook computer)

Electrical data	
Primary	
Nominal voltage	100 V – 240 V (automatic)
Nominal frequency	50 Hz to 60 Hz (automatic)
Secondary	
Nominal power	65 W
Rated voltage	20 V
Maximum rated current	3.25 A
Connector type	USB Type-C

An additional mains adapter or power cable can be ordered at any time.

Mains adapter (port replicator)

Electrical data	
Rated voltage	100 V to 240 V (automatic)
Rated frequency	50 Hz – 60 Hz (automatic)
Secondary	
Nominal power	90 W
Nominal voltage	19 V
Max. rated current	4.74 A

An additional mains adapter or power cable can be ordered at any time.

Manufacturer's notes

Disposal and recycling

If the battery is not replaceable by the user, have it replaced and disposed of by an authorized service provider.

Information about this subject can be found on your notebook or on our website:

["https://www.fujitsu.com/emeia/about/local/csr/recycling/"](https://www.fujitsu.com/emeia/about/local/csr/recycling/)

TCO Certified

Please note that TCO-certified systems bear the "TCO certified" logo. Further information is given in the "TCO certified" manual appendix at ["http://support.ts.fujitsu.com/Manuals/"](http://support.ts.fujitsu.com/Manuals/).

SAR limit value (Specific Absorption Rate)

Body SAR value < 2W/kg

Other certification markings

Any other certification markings are listed in the "Manual Appendix - Additional Certifications" supplement.

If such markings are available, you can find the supplement on the Internet at ["http://support.ts.fujitsu.com/Manuals/"](http://support.ts.fujitsu.com/Manuals/) with the Operating Manual for your device.

The model names for certifications are as follows:

- LIFEBOOK U7312 Model: 7U13A3
- LIFEBOOK U7412 Model: 7U14A3
- LIFEBOOK U7512 Model: 7U15A3

Index

A

Alt + Tab 33
 Anti-theft protection 54
 Audio ports 64

B

Back tab 33
 Background lighting 34
 Backspace 29
 Battery
 battery life 39
 caring for and maintaining 39
 charge level 39, 41
 charging 39
 Battery indicator 26
 Battery status indicator
 see Battery indicator 26
 Battery status meter 39
 Battery symbol
 see Battery indicator 26
 BIOS Setup Utility
 calling 66
 exiting 68
 operating 67
 protecting with password 55
 settings 66
 Bluetooth
 Switching the module off 47
 Switching the module on 47
 Bluetooth, safety notes 19
 Buttons 28

C

Caps Lock 29
 indicator 26
 Certification markings 82
 Cleaning 21
 Components
 installing / removing 65
 Configuration, BIOS Setup Utility 66
 Connecting audio devices 64
 Connecting headphones 64
 Ctrl+Alt+Del 33
 Cursor control 29
 Cursor keys 29

D

Date is incorrect 72
 Device

 setting up 23
 Disable
 microphone 31
 Display port 60
 Drive
 Restore content 72

E

Enable
 microphone 31
 Energy
 energy saving 19
 Energy saving 19
 Energy saving functions 32
 Energy saving mode
 leaving 74
 Enter 29
 Enter key 29
 Error message:
 on the screen 77
 Error messages on the screen 77
 Ethernet LAN 48

F

F Lock
 Indicator 26
 F1 31
 F10 32
 F2 31
 F3 31
 F4 32
 F5 32
 F6 32
 F7 32
 F8 32
 F9 32
 Fault
 correction 71
 Fingerprint sensor 53
 configure 53
 First-time setup 22
 Fn key 29

G

Getting started 22

H

Hardware configuration 66
 HDMI port 60

- I**
- Important notes 18
- Incorrect date/time 72
- Indicator
 - Caps Lock 26
 - F Lock 26
 - Num Lock 26
 - Scroll Lock 26
- Intel Thunderbolt 62

- K**
- Key combinations 31
- Keyboard 28
 - Background lighting 34
 - cleaning 21

- L**
- LCD screen
 - cleaning 21
 - decrease brightness 32
 - difficult to read 73
 - notes 36
 - reflected glare 73
 - remains blank 73
- LCD screen is too dark 73
- Life, battery 39
- Line feed 29
- Loudspeakers 44
 - switch off 31
 - switch on 31

- M**
- Mains adapter
 - connecting 23
 - setting up 23
- Mechanical backup 54
- Memory card
 - handling 43
 - inserting 43
 - removing 43
- Microphone 44
- Mobile operation 20
- Monitor
 - connecting 60
 - drifting display 74
 - remains blank 73
- Monitor port
 - see VGA screen port 60

- N**
- Notebook
 - before you travel 20
 - cannot be started 74
 - cleaning 21
 - stops working 74
 - switching off 27
 - transporting 20
 - using 25
- Notebook, operation 25
- Notes 18
 - cleaning 21
 - disposal / recycling 82
 - energy saving 19
 - LCD screen 36
 - Safety 18
 - transport 20
- Num Lock
 - indicator 26, 30–31
- Numeric keypad 28
 - see Separate numeric keypad 31
 - see Virtual numeric keypad 30

- O**
- Operating system
 - activating system protection 57
 - cancel system protection 57
 - protecting with password 57
- Operating system, restoring 72

- P**
- Packaging 22
- Palm vein sensor 54
 - Configuring 54
- Password
 - changing 56
 - entering 56
 - removing 56
- Password protection 55
- Port Replicator
 - Connecting a notebook 50
- Ports 49
 - Port Replicator 49
- Power
 - power consumption 41
 - power-management features 41
- Power-on indicator 26
- Preparing for operation 23
- Printer does not print 75

- R**
- Rechargeable battery 39
 - see Battery 39

- Return 29
- S**
- Safety notes 18
- SAR 82
- Screen
 - no screen display 74
- Screen brightness
 - decrease 32
 - increase 32
- Screen port
 - see display port 60
 - see HDMI port 60
 - see VGA screen port 60
- Scroll Lock
 - indicator 26
- Security functions 53
 - SystemLock 58
- Security functions, SmartCard 58
- Security Lock 54
- Selecting a location 23
- Separate numeric keypad 31
- Servicing 65
- Setup
 - see BIOS Setup Utility 66
- Shift 29
- Shift + Tab 33
- Shift key 29
- Slot
 - Memory cards 43
- Standby indicator 26
- Status indicators 25
- Supervisor password
 - changing 56
 - entering 56
 - removing 56
- Switching on
 - the notebook 27
- Switching on for the first time 24
- System configuration 66
- System settings, BIOS Setup Utility 66
- T**
- Tab key 29
- TCO Certified 82
- Technical data 79
 - Mains adapter 80–81
 - notebook 79
- The wireless connection to a network
 - does not work 75
- Time not correct 72
- Tips 71
- Toggle output screen 32
- Touchpad 32, 35
 - buttons 35
 - cleaning 21
 - dragging items 36
 - executing commands 35
 - moving the pointer 35
 - selecting an item 35
 - switch off 32
- Touchpad buttons 32
- Transport
 - Transport damage 22
- Transportation 20
- Travel, notebook 20
- Troubleshooting 71
- U**
- USB charging function 63
- USB ports 61
- USB-Anschluss mit Aufladefunktion (USB Type-C) 62
- User password
 - changing 56
 - entering 56
 - removing 56
- Using the Kensington Lock Cable 54
- V**
- VGA Display Port 60
- Virtual numeric keypad 30
- Volume
 - decrease 31
 - increase 32
- Volume control 44
- W**
- Webcam 38
- Windows key 29
- Wireless component:
 - safety notes 19
- Wireless components
 - switch off 32
 - switch on 32
- Wireless LAN
 - Switching the module off 47
 - Switching the module on 47
- Wireless LAN:
 - safety notes 19