





# REPAIR HINTS

[bg]	Съвети за ремонт .....	2
[hr]	Savjeti za popravak .....	25
[cs]	Poznámky k opravě .....	47
[da]	Tip til reparation .....	70
[nl]	Reparatie informatie .....	92
[en]	Repair hints .....	115
[et]	Remonditeave .....	138
[fi]	Korjausvinkit .....	160
[fr]	Conseils de réparation .....	182
[de]	Reparatur Hinweise .....	205
[el]	Υποδείξεις επισκευής .....	228
[hu]	Javítási útmutató .....	251
[it]	Consigli di riparazione .....	274
[lv]	Informācija par remontu .....	297
[lt]	Informacija apie remontą .....	319
[no]	Reparasjonstips .....	341
[pl]	Wskazówki naprawy .....	363
[pt]	Dicas de resolução .....	386
[ro]	Indicii pentru reparații .....	409
[sk]	Poznámky k opravám .....	432
[sl]	Nasveti za popravilo .....	455
[es]	Consejos de reparación .....	477
[sv]	Reparationsinformation .....	500
[tr]	Onarım İpuçları .....	522

# Съвети за ремонт - Фризер

 <b>Относно този документ</b> .....	<b>3</b>
1.1 Важна информация.....	3
1.1.1 Цел.....	3
1.2 Обяснение на символите.....	3
1.2.1 Нива на опасност.....	3
1.2.2 Символи за опасност.....	3
1.2.3 Структура на предупрежденията.....	4
1.2.4 Общи символи.....	4
 <b>Безопасност</b> .....	<b>5</b>
2.1 Общи инструкции за безопасност.....	5
2.1.1 Всички домашни уреди.....	5
 <b>Инструменти и помощни средства</b> .....	<b>6</b>
 <b>Ремонт</b> .....	<b>7</b>
4.1 Смяна на уплътнителя на вратата.....	7
4.1.1 Сваляне на уплътнителя на вратата.....	7
4.1.2 Монтиране на уплътнителя на вратата.....	7
4.2 Смяна на дръжката на вратата.....	10
4.2.1 Изваждане на дръжката на вратата.....	10
4.2.2 Монтиране на дръжката на вратата.....	10
4.3 Смяна на easy opening handle.....	11
4.3.1 Сваляне на easy opening handle.....	11
4.3.2 Монтиране на easy opening handle.....	11
4.4 Смяна на горната панта на вратата.....	12
4.4.1 Сваляне на пантата на вратата.....	12
4.4.2 Монтиране на пантата на вратата.....	14
4.5 Смяна на горната панта на вратата (врата с дисплей).....	15
4.5.1 Сваляне на пантата на вратата.....	16
4.5.2 Монтиране на пантата на вратата.....	17
4.6 Смяна на долната панта на вратата.....	18
4.6.1 Смяна на долната панта на вратата.....	18
4.6.2 Монтиране на долната панта на вратата.....	19
4.7 Смяна на рафта.....	20
4.7.1 Изваждане на рафта.....	20
4.7.2 Монтиране на рафта.....	20

4.8 Смяна на контейнера за замразени хранителни продукти.....	21
4.8.1 Изваждане на контейнера за замразени хранителни продукти.....	21
4.8.2 Монтиране на контейнера за замразени хранителни продукти.....	21
4.9 Смяна на ледогенератора.....	22
4.9.1 Изваждане на ледогенератора.....	22
4.9.2 Монтиране на ледогенератора.....	22
4.10 Смяна на LED осветлението отгоре.....	23
4.10.1 Сваляне на LED осветлението.....	23
4.10.2 Монтиране на LED осветлението отгоре.....	24

# **i** Относно този документ

## 1.1 Важна информация

### 1.1.1 Цел

Тези съвети за ремонт помагат на потребителя да ремонтира сам уреди в съответствие с регламента за екологосъобразно проектиране на уредите (от 03.2021 г.).

Те съдържат информация как да сменят определени резервни части, включително предупреждения и рискове.

Ако имате някакви въпроси, моля свържете се с нашия отдел за обслужване на клиенти. Ние носим отговорност за щети, само ако съветите за ремонт са спазени правилно.

## 1.2 Обяснение на символите

### 1.2.1 Нива на опасност

Предупредителните нива се състоят от символ и сигнална дума. Сигналната дума показва сериозността на опасността.





Ниво на предупреждение	Значение
 <b>ОПАСНОСТ</b>	Неспазването на предупредителното съобщение ще доведе до смърт или сериозни наранявания.
 <b>ПРЕДУПРЕЖДЕНИЕ</b>	Неспазването на предупредителното съобщение може да доведе до смърт или сериозни наранявания.
 <b>ВНИМАТЕЛНО</b>	Неспазването на предупредителното съобщение може да доведе до леки наранявания.
<b>ВНИМАНИЕ!</b>	Неспазването на предупредителното съобщение може да доведе до имуществени щети.

Таблица 1: Нива на опасност

### 1.2.2 Символи за опасност

Символите за опасност са символични изображения, които дават индикация за вида опасност.

В този документ се използват следните символи за опасност:

Символ за опасност	Значение
	Общо предупредително съобщение
	Опасност от електрическо напрежение
	Риск от експлозия
	Опасност от порязвания

## **i** Относно този документ





Символ за опасност	Значение
	Опасност от премазване
	Опасност от горещи повърхности
	Опасност от силно магнитно поле
	Опасност от нейонизиращо лъчение

Таблица 2: Символи за опасност

### 1.2.3 Структура на предупрежденията

Предупрежденията в този документ имат стандартизиран външен вид и стандартизирана структура.

	<p><b>ОПАСНОСТ</b></p> <p><b>Вид и източник на опасността!</b> Възможни последици от игнориране на опасността/предупреждението.</p> <ul style="list-style-type: none"> <li>▶ Мерки и забрани за предотвратяване на опасността.</li> </ul>
--	---

Следният пример показва предупреждение, което уведомява за токов удар, предизвикан от части под напрежение. Споменава се мярката за избягване на опасността.

	<p><b>ОПАСНОСТ</b></p> <p><b>Риск от токов удар поради части под напрежение!</b> Смърт от токов удар</p> <ul style="list-style-type: none"> <li>▶ Изключете уредите от електрическото захранване поне 60 секунди преди започване на ремонта.</li> </ul>
--	---

### 1.2.4 Общи символи

В този документ се използват следните общи символи:







Общ символ	Значение
	Идентифициране на специален съвет (текст и/или графика)
	Идентифициране на прост съвет (само текст)
	Идентифициране на връзка към видео урок
	Идентифициране на необходимите инструменти
	Идентифициране на необходимите предварителни условия
	Идентифициране на условие (ако ..., тогава ...)
	Идентифициране на резултат
Старт	Идентифициране на ключ или бутон
[00123456]	Идентифициране на каталожен номер
Статус	Идентифициране на показания текст/прозорец (на дисплея на уреда)

Таблица 3: Общи символи

## **2.1 Общи инструкции за безопасност**

### **2.1.1 Всички домашни уреди**

#### **Риск от токов удар поради части под напрежение!**

- Грешки при ремонти, включващи електрически компоненти, могат да доведат до токов удар!
- Разкачете уреда от електрическата мрежа за поне 60 секунди, преди да започнете работа.
- След ремонта трябва да се извърши проверка за безопасност съгласно VDE 0701 или в съответствие със специфичните за страната разпоредби.

#### **Риск от нараняване от остри ръбове!**

- Носете предпазни ръкавици.

#### **Риск от премазване по време на ремонт, поддръжка, отстраняване на неизправности и сервиз поради тежки и движещи се компоненти**

- Носете защитни обувки.
- Закрепете тежките компоненти, така че да не паднат.
- Не позволявайте контакт на части от тялото с движещи се компоненти.

#### **Риск за безопасността/функцията на уреда!**

- Използвайте само оригинални резервни части.

#### **Риск от повреда на електростатично чувствителни компоненти (ESD)!**

- Не докосвайте модулите, включително връзки и проводникови пътища.

## Инструменти и помощни средства

посочване	Подробности	Изображения
Защитна кърпа [00342013]	60 см x 50 см	
Кръстата отвертка PH2		
Накрайник Torx TX20 [00340865]	6,3 мм (1/4")	
Плоска отвертка	Врх 2,4 мм x 0,4 мм x 60 мм, в комплекта [00341820]	

## 4.1 Смяна на уплътнителя на вратата

### Изискване:

- ✔ Вратата е отворена.

### 4.1.1 Сваляне на уплътнителя на вратата

1. Освободете уплътнителя на вратата от жлеба отляво и отдясно.





2. Извадете уплътнителя на вратата от жлеба.



- ➡ Уплътнителят на вратата е свален.

### 4.1.2 Монтиране на уплътнителя на вратата

	Дебелината на новия уплътнител на вратата може леко да се отличава от тази на стария уплътнител. Това няма да повлияе на начина на затваряне и нейната работа в дългосрочен план.
	Ако вашият уред има регулируеми панти или приставки за панти, можете да оптимизирате начина на затваряне по-късно.
	Малките странични отвори в уплътнителя на вратата са функционални (необходими за вентилация). Те не са производствени грешки.

1. Проверете жлеба на уплътнителя за повреди.



4. Натиснете ъглите на уплътнителя отгоре и отдолу към жлеба.

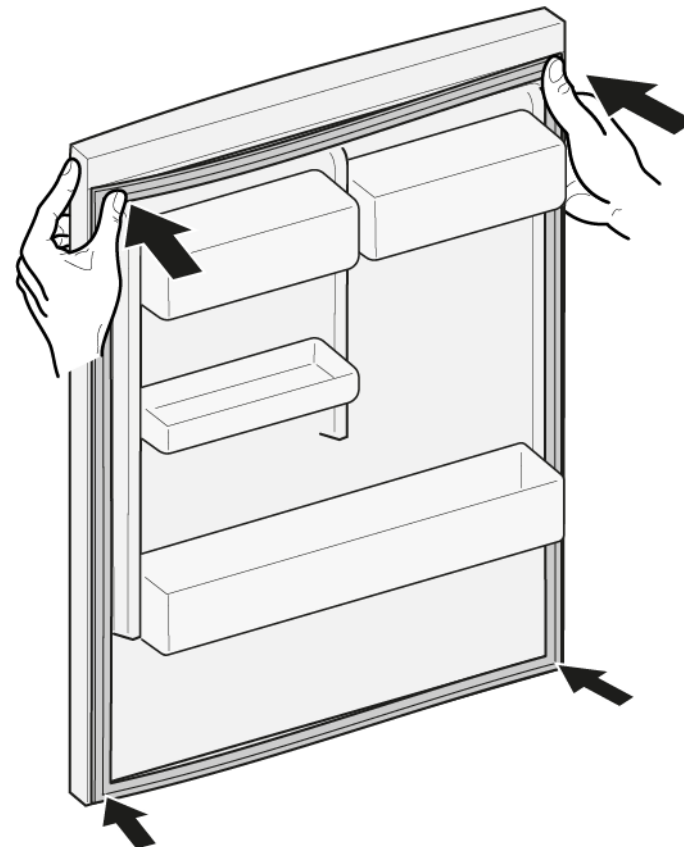

2.  Ако жлебът на уплътнителя е повреден:  
- Свържете се с отдела за обслужване на клиенти.

3.  Леката деформация на уплътнителя на вратата е нормална и не засяга неговата функция. Препоръчително е да изправите уплътнителя на вратата, преди да го поставите в уреда.

Загрейте уплътнителя на вратата със сешоар или гореща вода и променете формата му.





5. Постепенно вкарайте с натискане целия уплътнител в жлеба.





 Уплътнителят на вратата е монтиран.

## 4.2 Смяна на дръжката на вратата

### Специални инструменти:

-  Накрайник Torx TX20      6,3 мм (1/4")      [00340865]
-  Плоска отвертка      Врѝх 10 мм x 1,6 мм x 200 мм

### Изискване:

-  Уредът е изключен от захранването.
-  Вратата е отворена.

### 4.2.1 Изваждане на дръжката на вратата

- ▶ 1. Свалете двете капачки на винтовете (1).
- ▶ 2. Развийте двата винта (2).
- ▶ 3. Свалете дръжката на вратата (3).

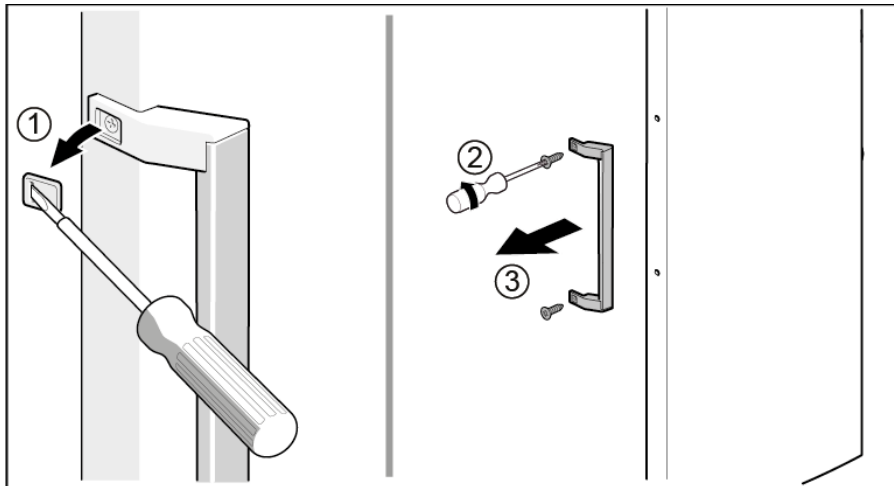

-  Дръжката на вратата е свалена.

### 4.2.2 Монтиране на дръжката на вратата



- ▶ Монтирайте в обратен ред.

### 4.3 Смяна на easy opening handle

Специални инструменти:

-  Кръстата отвертка PH2

Изискване:

-  Уредът е изключен от захранването.
-  Вратата е отворена.

#### 4.3.1 Сваляне на easy opening handle

- ▶ 1. Свалете капачето на easy opening handle (1).
- ▶ 2. Развийте двата винта (2).

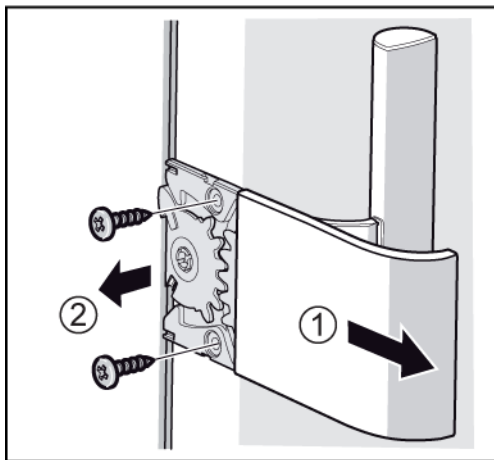

-  Easy opening handle е свалена.

#### 4.3.2 Монтиране на easy opening handle

Механизмът на easy opening handle трябва да бъде правилно настроен преди монтажа. Правилното разположение на буталния прът (1), назъбените квадранти (2) и (3), пружината (4) и ограничителя (5) за монтаж на вратата отляво е показано на графиката.

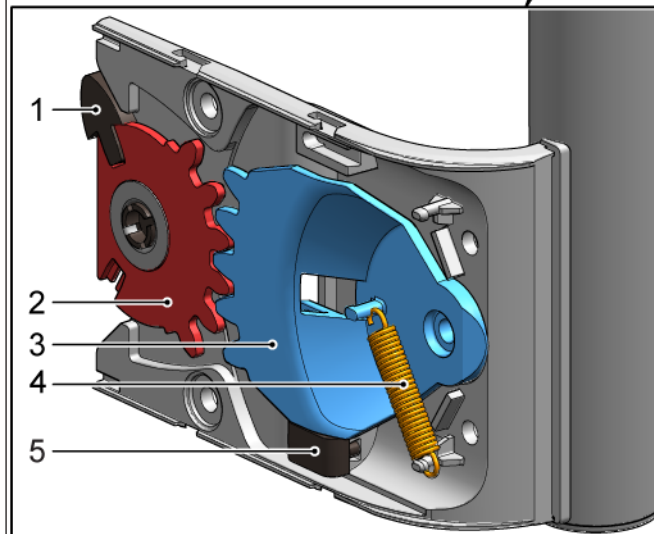
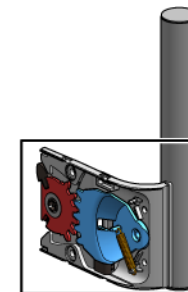

Разположението на подкомпонентите на easy opening handle при монтаж на вратата отляво е описано в документа "Инструкция за монтаж".

- ▶ Монтирайте в обратен ред.

## 4.4 Смяна на горната панта на вратата

Специални инструменти:

 Накрайник Torx TX20      6,3 мм (1/4")      [00340865]

	<b>⚠ ПРЕДУПРЕЖДЕНИЕ</b>
	<b>Тежки, обемисти уреди!</b> Травми на гърба и мускулите <ul style="list-style-type: none"><li>▶ Операцията по отстраняване на вратите на уреда трябва да се извършва само от обучени специалисти.</li><li>▶ За преместването на уреда са необходими двама души.</li><li>▶ Използвайте само подходящи инструменти и оборудване.</li></ul>

	<b>⚠ ВНИМАТЕЛНО</b>
	<b>Остри ръбове!</b> Наранявания от порязване <ul style="list-style-type: none"><li>▶ Носете предпазни ръкавици.</li></ul>

	<b>⚠ ПРЕДУПРЕЖДЕНИЕ</b>
	<b>Приплъзване на наклонени уреди!</b> Костни фрактури/наранявания от премазване <ul style="list-style-type: none"><li>▶ Укрепете уредите срещу приплъзване.</li></ul>

	<b>⚠ ВНИМАТЕЛНО</b>
	<b>Риск от падащи части поради разхлабени винтове!</b> Нараняване поради падащи части. <ul style="list-style-type: none"><li>▶ Закрепете компонента, така че да не падне.</li></ul>

	<b>ВНИМАНИЕ!</b>
	<b>Риск от падащи части поради разхлабени винтове!</b> Повреда на други части на уреда или в дома на клиента, напр. дъното. <ul style="list-style-type: none"><li>▶ Закрепете компонента, така че да не падне.</li></ul>

Изискване:

- ✔ Уредът е изключен от захранването.
- ✔ Вътрешните фитинги на уреда са отстранени.

### 4.4.1 Сваляне на пантата на вратата

1. Поставете уреда легнал на задната си страна.

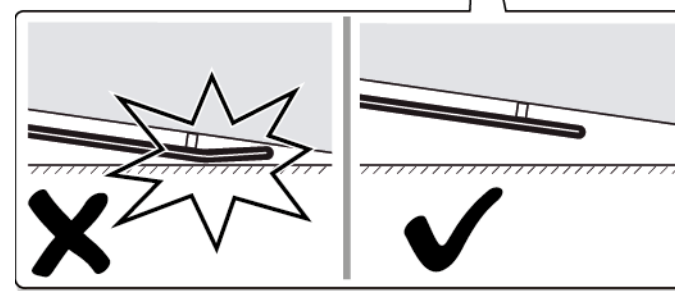
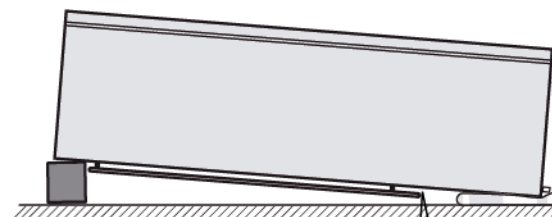
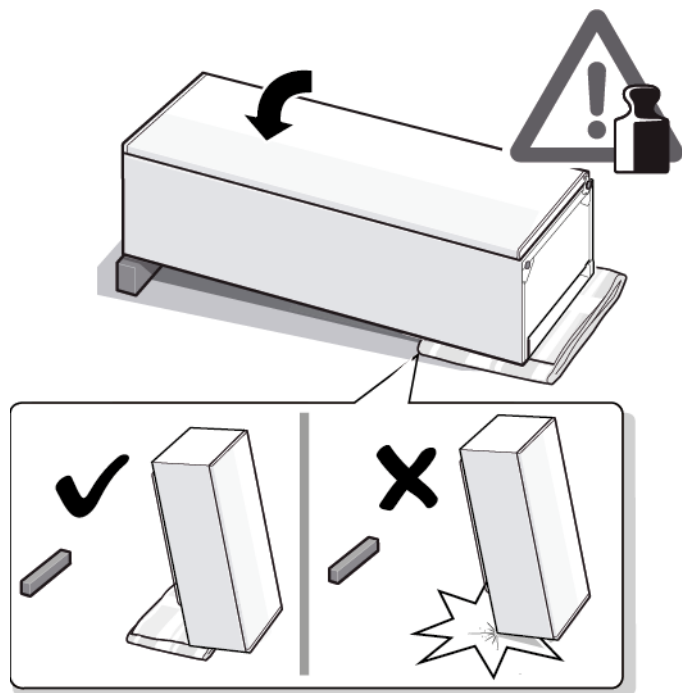

2. 1. Натиснете капачето на горната панта от двете страни (1).
2. Извадете капачето на горната панта (2).
3. Свалете капачето на горната панта (3).

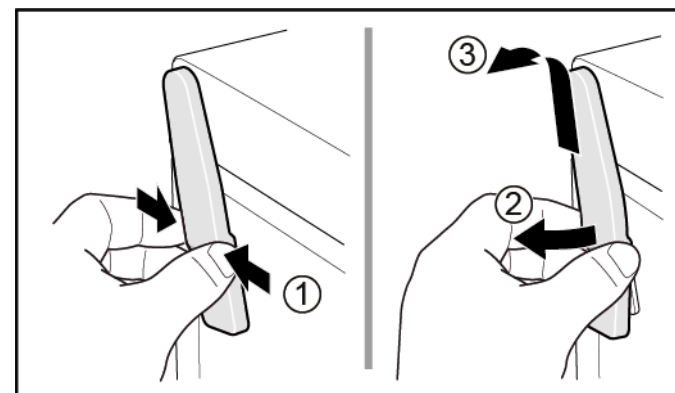

3. 1. Развийте двата винта (1).
2. Свалете горната панта (2).

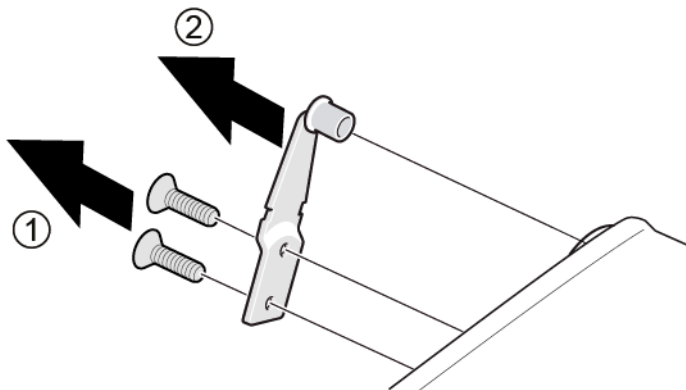

 Горната панта на вратата е свалена.

#### 4.4.2 Монтиране на пантата на вратата

- ▶ Монтирайте в обратен ред.

#### 4.5 Смяна на горната панта на вратата (врата с дисплей)

Специални инструменти:

 Накрайник Torx TX20      6,3 мм (1/4")      [00340865]

	<b>⚠ ПРЕДУПРЕЖДЕНИЕ</b>
	<p><b>Тежки, обемисти уреди!</b> Травми на гърба и мускулите</p> <ul style="list-style-type: none"> <li>▶ Операцията по отстраняване на вратите на уреда трябва да се извършва само от обучени специалисти.</li> <li>▶ За преместването на уреда са необходими двама души.</li> <li>▶ Използвайте само подходящи инструменти и оборудване.</li> </ul>

	<b>⚠ ВНИМАТЕЛНО</b>
	<p><b>Остри ръбове!</b> Наранявания от порязване</p> <ul style="list-style-type: none"> <li>▶ Носете предпазни ръкавици.</li> </ul>

	<b>⚠ ПРЕДУПРЕЖДЕНИЕ</b>
	<p><b>Приплъзване на наклонени уреди!</b> Костни фрактури/наранявания от премазване</p> <ul style="list-style-type: none"> <li>▶ Укрепете уредите срещу приплъзване.</li> </ul>



	<b>⚠ ВНИМАТЕЛНО</b>
	<p><b>Риск от падащи части поради разхлабени винтове!</b> Нараняване поради падащи части.</p> <ul style="list-style-type: none"> <li>▶ Закрепете компонента, така че да не падне.</li> </ul>

	<b>ВНИМАНИЕ!</b>
	<p><b>Риск от падащи части поради разхлабени винтове!</b> Повреда на други части на уреда или в дома на клиента, напр. дъното.</p> <ul style="list-style-type: none"> <li>▶ Закрепете компонента, така че да не падне.</li> </ul>

	<b>⚠ ОПАСНОСТ</b>
	<p><b>Риск от токов удар поради части под напрежение!</b> Опасност за живота от токов удар в случай на неправилен ремонт</p> <ul style="list-style-type: none"> <li>▶ Електрическите части трябва да се ремонтират от квалифицирани електротехници.</li> <li>▶ След ремонта трябва да се извърши проверка за безопасност съгласно VDE 0701 или в съответствие със специфичните за страната разпоредби.</li> </ul>

	<b>⚠ ОПАСНОСТ</b>
	<p><b>Риск от токов удар поради части под напрежение!</b> Смърт от токов удар</p> <ul style="list-style-type: none"> <li>▶ Изключете уредите от електрическото захранване поне 60 секунди преди започване на ремонта.</li> </ul>

**Изискване:**

-  Уредът е изключен от захранването.
-  Вътрешните фитинги на уреда са отстранени.

#### 4.5.1 Сваляне на пантата на вратата

1. Поставете уреда легнал на задната си страна.

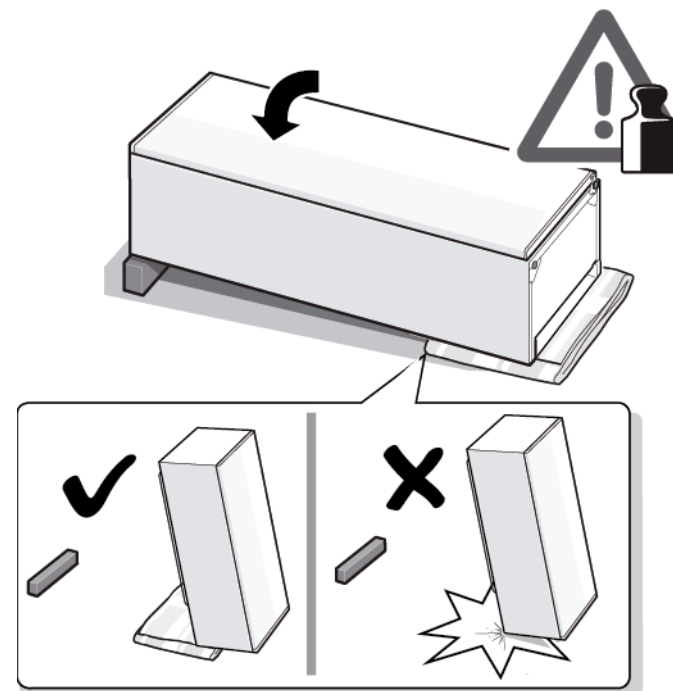



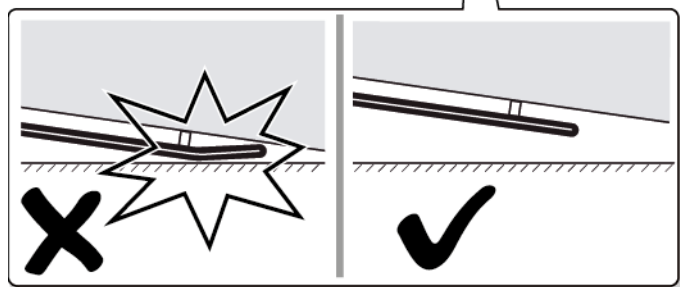
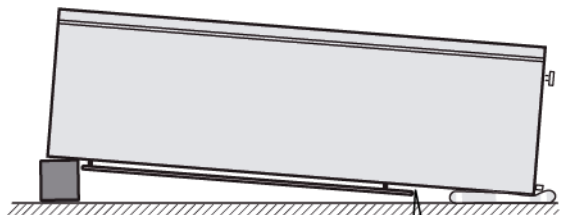

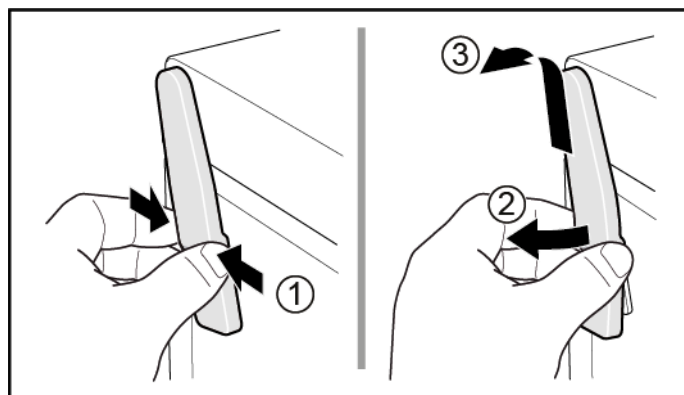

2. 1. Натиснете капачето на горната панта от двете страни (1).
2. Извадете капачето на горната панта (2).
3. Свалете капачето на горната панта (3).

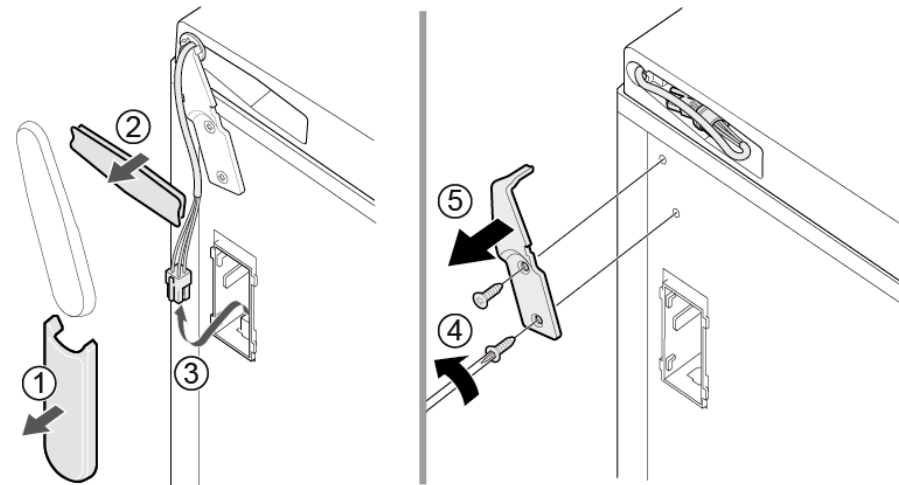

3. 1. Свалете капака на кабелната кутия (1).
2. Свалете кабелната защита (2).
3. Изключете електрическата връзка (3).
4. Развийте двата винта (4).
5. Свалете горната панта (5).



 Горната панта на вратата е свалена.

#### 4.5.2 Монтиране на пантата на вратата

- ▶ Монтирайте в обратен ред.

## 4.6 Смяна на долната панта на вратата

Специални инструменти:

 Накрайник Torx TX20      6,3 мм (1/4")      [00340865]

	<b>⚠ ПРЕДУПРЕЖДЕНИЕ</b>
	<p><b>Тежки, обеимисти уреди!</b> Травми на гърба и мускулите</p> <ul style="list-style-type: none"> <li>▶ Операцията по отстраняване на вратите на уреда трябва да се извършва само от обучени специалисти.</li> <li>▶ За преместването на уреда са необходими двама души.</li> <li>▶ Използвайте само подходящи инструменти и оборудване.</li> </ul>



	<b>⚠ ВНИМАТЕЛНО</b>
	<p><b>Остри ръбове!</b> Наранявания от порязване</p> <ul style="list-style-type: none"> <li>▶ Носете предпазни ръкавици.</li> </ul>

	<b>⚠ ПРЕДУПРЕЖДЕНИЕ</b>
	<p><b>Приплъзване на наклонени уреди!</b> Костни фрактури/наранявания от премазване</p> <ul style="list-style-type: none"> <li>▶ Укрепете уредите срещу приплъзване.</li> </ul>

	<b>⚠ ВНИМАТЕЛНО</b>
	<p><b>Риск от падащи части поради разхлабени винтове!</b> Нараняване поради падащи части.</p> <ul style="list-style-type: none"> <li>▶ Закрепете компонента, така че да не падне.</li> </ul>

	<b>ВНИМАНИЕ!</b>
	<p><b>Риск от падащи части поради разхлабени винтове!</b> Повреда на други части на уреда или в дома на клиента, напр. дъното.</p> <ul style="list-style-type: none"> <li>▶ Закрепете компонента, така че да не падне.</li> </ul>

Изискване:

-  Уредът е изключен от захранването.
-  Вътрешните фитинги на уреда са отстранени.
-  Уредът е поставен легнал назад.

 [Горната панта е свалена.→15](#)

### 4.6.1 Смяна на долната панта на вратата

1. Извадете вратата.

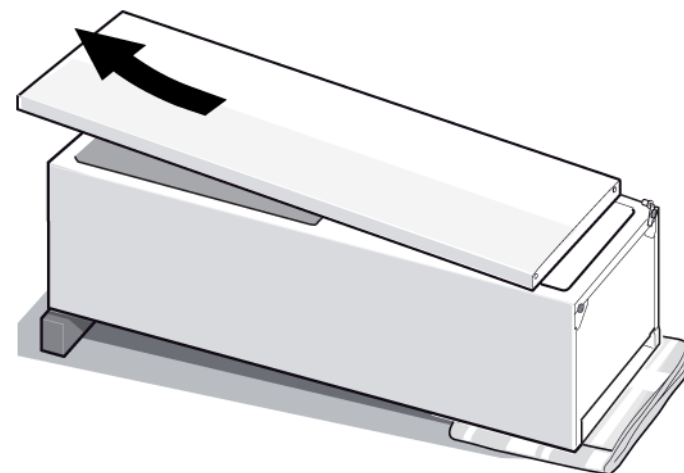

- 2.
1. Развийте винта (1).
  2. Извъртете долната панта навън (2).
  3. Свалете долната панта (3).

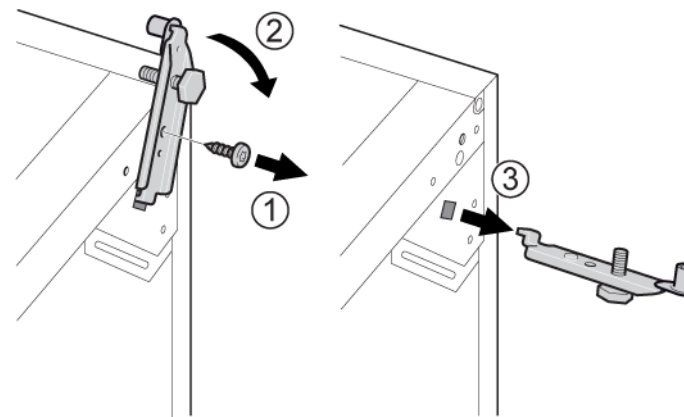

 Долната панта е свалена.

#### 4.6.2 Монтиране на долната панта на вратата

- ▶ Монтирайте в обратен ред.

## 4.7 Смяна на рафта

### Изискване:

- ✔ Вратата е отворена.

### 4.7.1 Изваждане на рафта

- ▶ Издърпайте рафта.

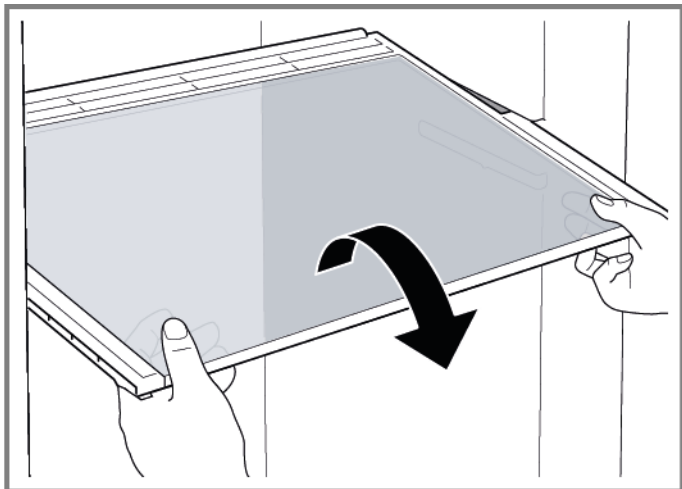

- ➡ Рафтът е свален.

### 4.7.2 Монтиране на рафта

- ▶ Монтирайте в обратен ред.

## 4.8 Смяна на контейнера за замразени хранителни продукти

### Изискване:

- ✓ Вратата е отворена.

### 4.8.1 Изваждане на контейнера за замразени хранителни продукти

- ▶ 1. Издърпайте докрай контейнера за замразени хранителни продукти (1).
- ▶ 2. Извадете контейнера за замразени хранителни продукти (2).

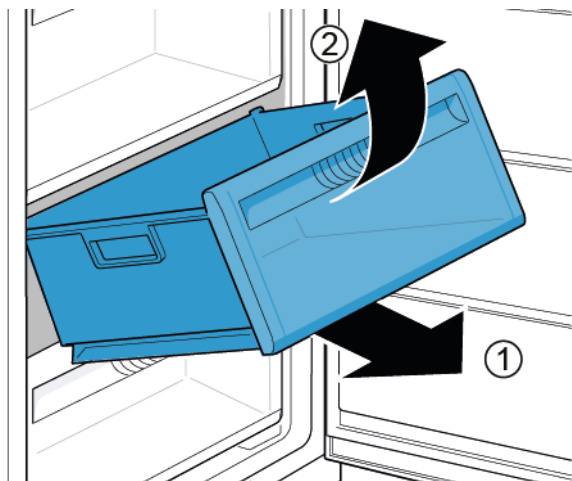

- ➡ Контейнерът за замразени хранителни продукти е изваден.

### 4.8.2 Монтиране на контейнера за замразени хранителни продукти

- ▶ Монтирайте в обратен ред.

## 4.9 Смяна на ледогенератора

### Изискване:

- ✔ Вратата е отворена.

### 4.9.1 Изваждане на ледогенератора

- ▶ 1. Издърпайте рафта с контейнера за замразени хранителни продукти и ледогенератора (1).
- ▶ 2. Освободете куките (2).
- ▶ 3. Извадете ледогенератора (3).

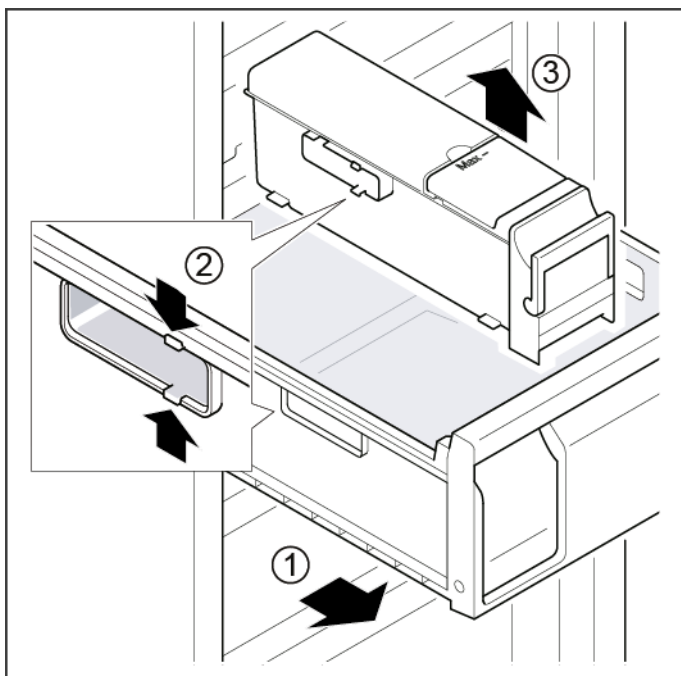

➡ Ледогенераторът е изваден.

### 4.9.2 Монтиране на ледогенератора

- ▶ Монтирайте в обратен ред.

## 4.10 Смяна на LED осветлението отгоре

### Специални инструменти:

-  Плоска отвертка      Врѝх 2,4 мм x 0,4 мм x 60 мм, в комплекта [00341820]



	<p>Вашият уред е снабден с LED осветление, което не изисква поддръжка. Това осветление може да бъде ремонтирано само от специалисти от службата за обслужване на клиенти или от квалифицирани техници!</p>
---	--

	<p style="text-align: center;"><b>⚠ ОПАСНОСТ</b></p> <p><b>Риск от токов удар поради части под напрежение!</b> Опасност за живота от токов удар в случай на неправилен ремонт</p> <ul style="list-style-type: none"> <li>▶ Електрическите части трябва да се ремонтират от квалифицирани електротехници.</li> <li>▶ След ремонта трябва да се извърши проверка за безопасност съгласно VDE 0701 или в съответствие със специфичните за страната разпоредби.</li> </ul>
--	--

	<p style="text-align: center;"><b>⚠ ОПАСНОСТ</b></p> <p><b>Риск от токов удар поради части под напрежение!</b> Смърт от токов удар</p> <ul style="list-style-type: none"> <li>▶ Изключете уредите от електрическото захранване поне 60 секунди преди започване на ремонта.</li> </ul>
--	---

	<p style="text-align: center;"><b>⚠ ВНИМАТЕЛНО</b></p> <p><b>Остри ръбове!</b> Наранявания от порязване</p> <ul style="list-style-type: none"> <li>▶ Носете предпазни ръкавици.</li> </ul>
--	--

### Изискване:

-  Уредът е изключен от захранването.
-  Вратата е отворена.
-  Горните вътрешни фитинги се отстраняват.

### 4.10.1 Сваляне на LED осветлението

1. Преместете LED осветлението наляво.

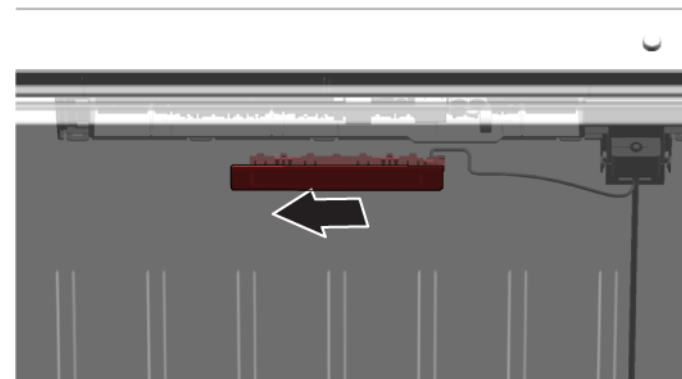

-  Свързването към електрическата мрежа на LED осветлението е прекъснато.

2. Освободете кукиите на LED осветлението.

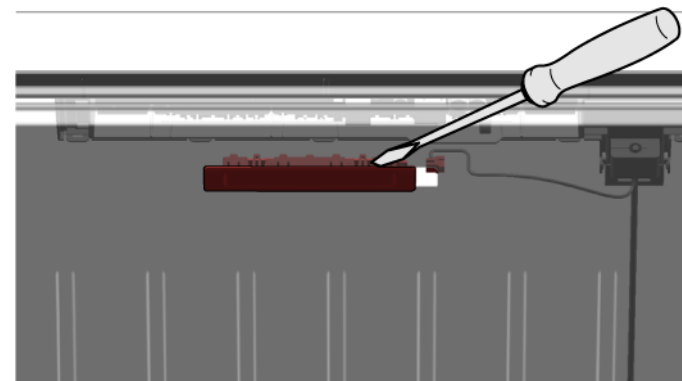

3. Свалете LED осветлението, придвижвайки го напред.

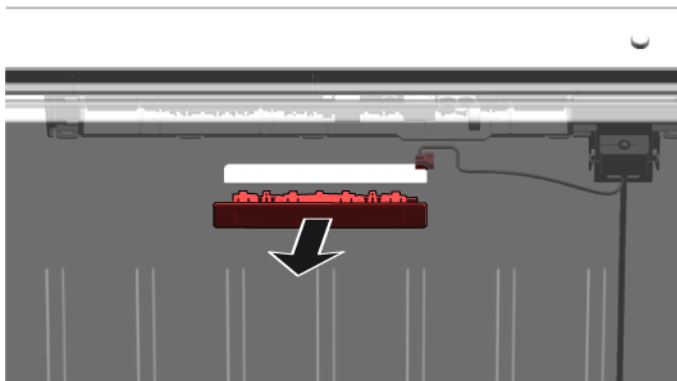





- ➔ LED осветлението е свалено.

#### 4.10.2 Монтиране на LED осветлението отгоре

- ▶ Монтирайте в обратен ред.



# Savjeti za popravak - Zamrzivač

 <b>O ovom dokumentu</b> .....	<b>26</b>
1.1 Važne informacije .....	26
1.1.1 Svrha .....	26
1.2 Objasnjenje oznaka .....	26
1.2.1 Stupnjevi opasnosti .....	26
1.2.2 Oznake opasnosti .....	26
1.2.3 Struktura upozorenja .....	27
1.2.4 Opće oznake .....	27
 <b>Sigurnost</b> .....	<b>28</b>
2.1 Opće sigurnosne upute .....	28
2.1.1 Svi kućanski uređaji .....	28
 <b>Alat i pomagala</b> .....	<b>29</b>
 <b>Popravak</b> .....	<b>30</b>
4.1 Zamjena brtve vrata .....	30
4.1.1 Uklanjanje brtve vrata .....	30
4.1.2 Postavljanje brtve vrata .....	30
4.2 Zamjena ručke za vrata .....	33
4.2.1 Uklanjanje ručke za vrata .....	33
4.2.2 Postavljanje ručke za vrata .....	33
4.3 Zamjena ručke easy opening handle .....	34
4.3.1 Uklanjanje ručke easy opening handle .....	34
4.3.2 Postavljanje ručke easy opening handle .....	34
4.4 Zamjena gornjeg zgloba vrata .....	35
4.4.1 Uklanjanje zgloba vrata .....	35
4.4.2 Postavljanje zgloba vrata .....	37
4.5 Zamjena gornjeg zgloba vrata (vrata sa zaslonom) .....	38
4.5.1 Uklanjanje zgloba vrata .....	39
4.5.2 Postavljanje zgloba vrata .....	40
4.6 Zamjena donjeg zgloba vrata .....	41
4.6.1 Zamjena donjeg zgloba vrata .....	41
4.6.2 Postavljanje donjeg zgloba vrata .....	41
4.7 Zamjena police .....	42
4.7.1 Uklanjanje police .....	42
4.7.2 Postavljanje police .....	42

4.8 Zamjena spremnika za zamrznute namirnice .....	43
4.8.1 Uklanjanje spremnika za zamrznute namirnice .....	43
4.8.2 Postavljanje spremnika za zamrznute namirnice .....	43
4.9 Zamjena ledomata .....	44
4.9.1 Uklanjanje ledomata .....	44
4.9.2 Postavljanje ledomata .....	44
4.10 Zamjena LED gornjeg svjetla .....	45
4.10.1 Uklanjanje LED svjetla .....	45
4.10.2 Postavljanje gornjeg LED svjetla .....	46

# **i** O ovom dokumentu

## 1.1 Važne informacije

### 1.1.1 Svrha

Ove upute za popravak služe kao podrška korisnicima prilikom samostalnog popravljivanja uređaja u skladu s primjenjivom Direktivom o ekološkom dizajnu (od ožujka 2021.).

One sadrže informacije o zamjeni određenih rezervnih dijelova, kao i napomene o upozorenjima i opasnostima.

Ako imate dodatna pitanja, obratite se našoj službi za korisnike. Mi snosimo odgovornost za oštećenja samo u slučaju pridržavanja uputa za popravak.

## 1.2 Objašnjenje oznaka

### 1.2.1 Stupnjevi opasnosti

Stupnjevi upozorenja sastoje se od oznake i signalne riječi. Signalna riječ ukazuje na ozbiljnost opasnosti.





Stupanj upozorenja	Značenje
 <b>OPASNOST</b>	Nepridržavanje poruke upozorenja rezultirat će smrtnim ili teškim ozljedama.
 <b>UPOZORENJE</b>	Nepridržavanje poruke upozorenja može rezultirati smrtnim ili teškim ozljedama.
 <b>OPREZ</b>	Nepridržavanje poruke upozorenja može rezultirati lakšim ozljedama.
 <b>POZORI!</b>	Nepridržavanje poruke upozorenja može rezultirati oštećenjem imovine.

Tablica 1: Stupnjevi opasnosti



### 1.2.2 Oznake opasnosti

Oznake opasnosti simbolička su reprezentacija s oznakom vrste opasnosti.

U ovom dokumentu koriste se sljedeće oznake opasnosti:

Oznaka opasnosti	Značenje
	Opća poruka upozorenja
	Opasnost od električnog napona
	Opasnost od eksplozije
	Opasnost od porezotina
	Opasnost od prignječenja

## O ovom dokumentu

Oznaka opasnosti	Značenje
	Opasnost od vrućih površina
	Opasnost od jakog magnetskog polja
	Opasnost od neionizirajućeg zračenja

Tablica 2: Oznake opasnosti

### 1.2.3 Struktura upozorenja

Upozorenja u ovom dokumentu imaju normirani izgled i strukturu.



	<div style="background-color: red; color: white; padding: 2px; text-align: center;"> <b>OPASNOST</b></div> <p><b>Vrsta i izvor opasnosti!</b> Moguće posljedice zanemarivanja opasnosti/upozorenja.</p> <ul style="list-style-type: none"> <li>▶ Mjere i zabrane za sprječavanje opasnosti.</li> </ul>
--	---





Sljedeći primjer pokazuje upozorenje na strujni udar od dijelova koji provode struju. Spominje se mjera za izbjegavanje opasnosti.

	<div style="background-color: red; color: white; padding: 2px; text-align: center;"> <b>OPASNOST</b></div> <p><b>Opasnost od strujnog udara zbog dijelova koji provode struju!</b> Smrt od strujnog udara</p> <ul style="list-style-type: none"> <li>▶ Isključite uređaj iz električnog napajanja najmanje 60 sekundi prije izvođenja popravaka.</li> </ul>
---	--

### 1.2.4 Opće oznake

U ovom dokumentu koriste se sljedeće opće oznake:

Opća znaka	Značenje
	Oznaka posebnog savjeta (tekst i/ili grafika)
	Oznaka jednostavnog savjeta (samo tekst)
	Oznaka veze na videovodič

Opća znaka	Značenje
	Oznaka potrebnog alata
	Oznaka potrebnih preduvjeta
	Oznaka uvjeta (ako ..., tad ...)
	Oznaka rezultata
[Početak]	Oznaka tipke ili gumba
[00123456]	Oznaka broja materijala
Status	Oznaka prikazanog teksta / prozor (na zaslonu uređaja)

Tablica 3: Opće oznake

## 2.1 Opće sigurnosne upute

### 2.1.1 Svi kućanski uređaji

#### **Opasnost od strujnog udara zbog dijelova koji provode struju!**

- Pogreške izazvane popravcima električnih sastavnih dijelova mogu dovesti do strujnog udara!
- Isključite uređaj iz struje na najmanje 60 sekundi prije početka radova.
- Nakon popravka provedite sigurnosni test u skladu s VDE 0701 ili nacionalnim propisima.

#### **Opasnost od ozljeda zbog oštih rubova!**

- Nosite zaštitne rukavice.

#### **Opasnost od prignječenja tijekom izvođenja radova na popravcima, održavanju, rješavanju problema i servisiranju teških i pokretnih sastavnih dijelova**

- Nosite zaštitnu obuću.
- Osigurajte teške sastavne dijelove od pada.
- Nemojte umetati dijelove tijela u pokretne sastavne dijelove.



#### **Opasnost za sigurnost/rad uređaja!**

- Koristite samo originalne rezervne dijelove.

#### **Opasnost od oštećenja elektrostatički osjetljivih sastavnih dijelova (ESD)!**

- Nemojte dodirivati module, uključujući priključke i rute vodiča.

## Alat i pomagala

Oznaka	Pojedinosti	Slike
Zaštitna navlaka [00342013]	60 cm x 50 cm	
Odvijač Phillips PH2		
Nastavak Torx TX20 [00340865]	6,3 mm (1/4")	
Odvijač s utorom	Nož 2,4 mm x 0,4 mm x 60 mm, u kompletu [00341820]	

## 4.1 Zamjena brtve vrata

### Zahtjev:

- ✔ Vrata su otvorena.

### 4.1.1 Uklanjanje brtve vrata

1. Otpustite brtvu vrata iz utora u desnom i lijevom kutu.



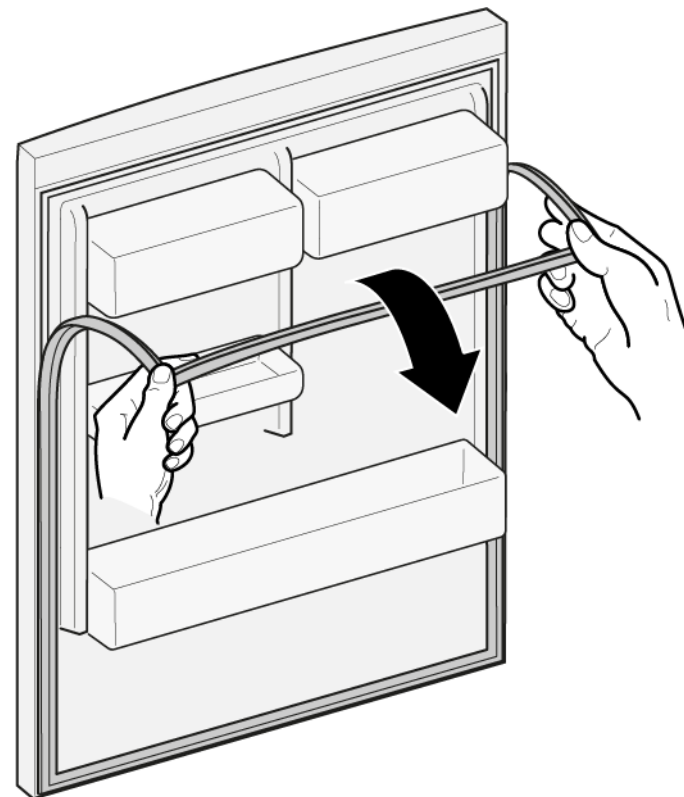

2. Izvucite brtvu vrata iz utora.



- ➡ Brtva vrata je uklonjena.

### 4.1.2 Postavljanje brtve vrata

	Debljina nove brtve vrata može malo odstupati od debljine stare brtve vrata. To neće utjecati na zatvaranje i dugoročnu funkciju.
	Ako uređaj ima prilagodljive zglobove ili nastavke zglobova, možete dodatno optimizirati zatvaranje.
	Mali bočni otvori u brtvi vrata su funkcijski (potrebni za ventilaciju). Nije riječ o proizvodnim pogreškama.

1. Provjerite ima li oštećenja na utoru za brtvu.

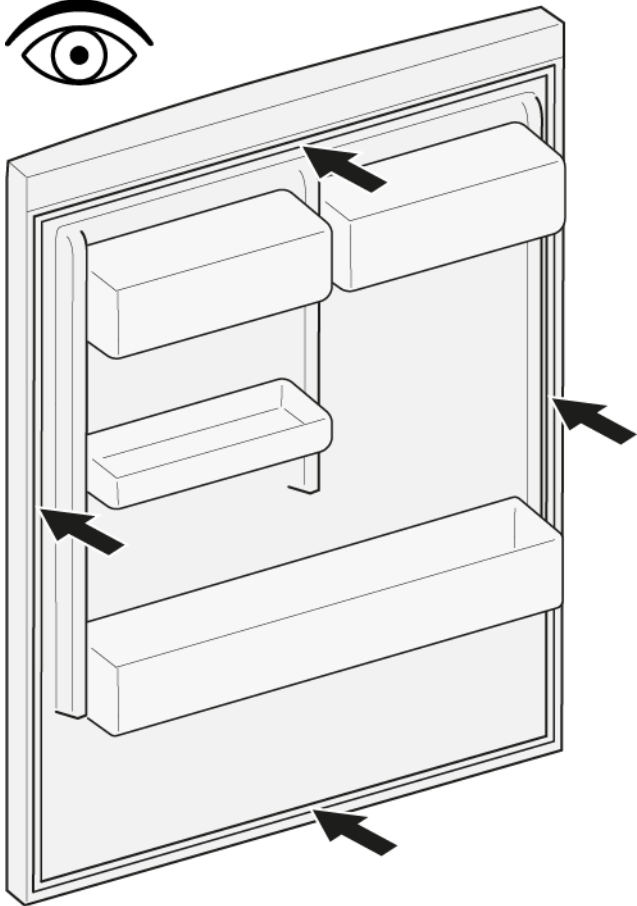

4. Gurnite kutove brtve na vrh i dno utora.

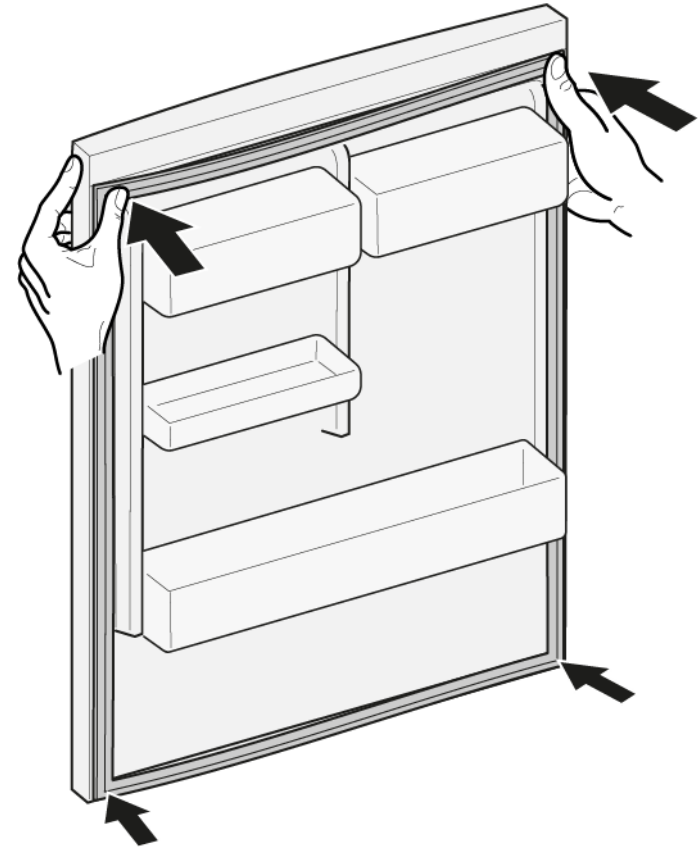

2.  Ako je utor za brtvu oštećen.  
- Obratite se službi za korisnike.

3.  Blago odstupanje brtve vrata normalno je i ne utječe na funkciju. Preporučuje se izravnati brtvu vrata prije umetanja u uređaj.

Zagrijte brtvu vrata sušilom za kosu ili vrućom vodom i ručno je oblikujte.

5. Utisnite cijelu brtvu korak po korak u utor.

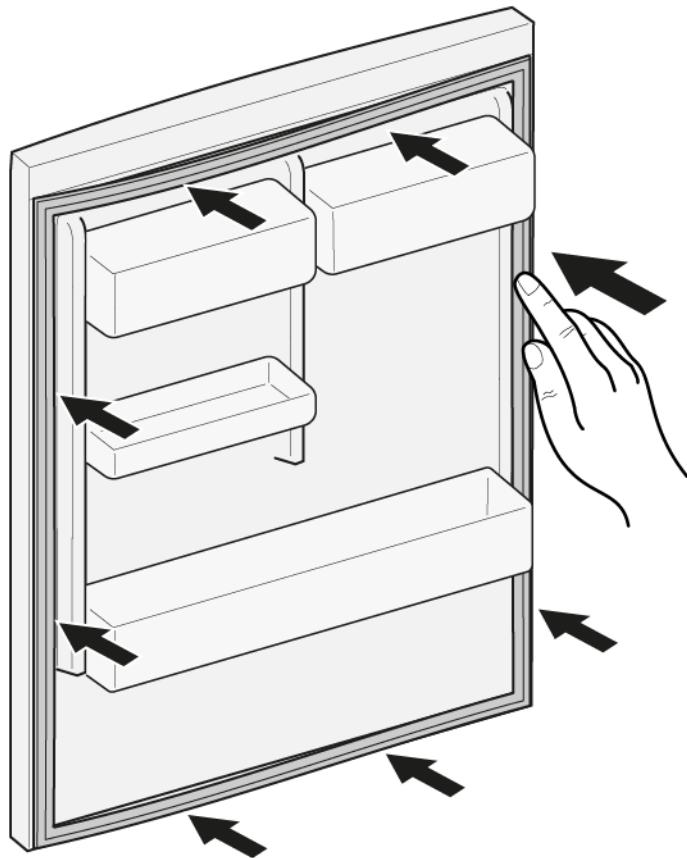



 Brtva vrata je postavljena.





## 4.2 Zamjena ručke za vrata

### Specijalni alati:

- |   |                             |            |
|---|-----------------------------|------------|
|  Nastavak Torx TX20 | 6,3 mm (1/4")               | [00340865] |
|  Odvijač s utorom   | Nož 10 mm x 1,6 mm x 200 mm |            |

### Zahtjev:

-  Uređaj je isključen iz napajanja.
-  Vrata su otvorena.

### 4.2.1 Uklanjanje ručke za vrata

- ▶ 1. Uklonite dva navojna čepa (1).
- ▶ 2. Odvijte dva vijka (2).
- ▶ 3. Uklonite ručku za vrata (3).

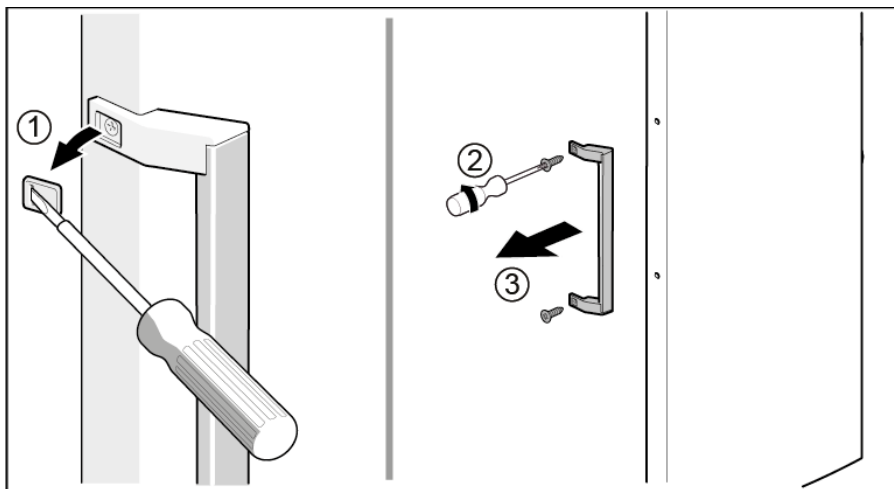

-  Ručka za vrata je uklonjena.

### 4.2.2 Postavljanje ručke za vrata

- ▶ Postavite obratnim redoslijedom.

## 4.3 Zamjena ručke easy opening handle

### Specijalni alati:

- 🔩 Odvijač Phillips PH2

### Zahtjev:

- ✅ Uređaj je isključen iz napajanja.
- ✅ Vrata su otvorena.

### 4.3.1 Uklanjanje ručke easy opening handle

- ▶ 1. Uklonite poklopac ručke easy opening handle (1).
- ▶ 2. Odvijte dva vijka (2).

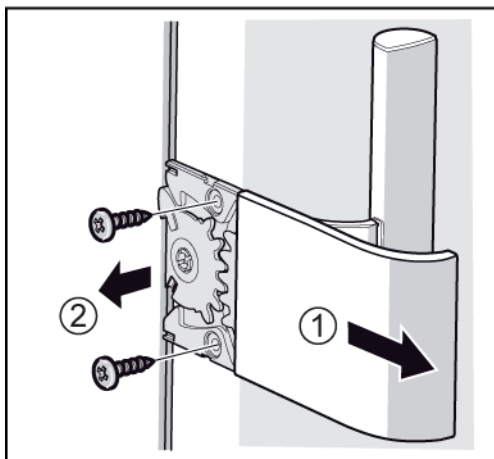

- ➡ Ručka easy opening handle je uklonjena.

### 4.3.2 Postavljanje ručke easy opening handle

Mehanizam ručke easy opening handle mora se pravilno namjestiti prije postavljanja. Ispravno namještanje potisne šipke (1), zupčastih kvadranta (2) i (3), opruge (4) i graničnika (5) za postavljanje lijeve strane vrata prikazano je na grafici.

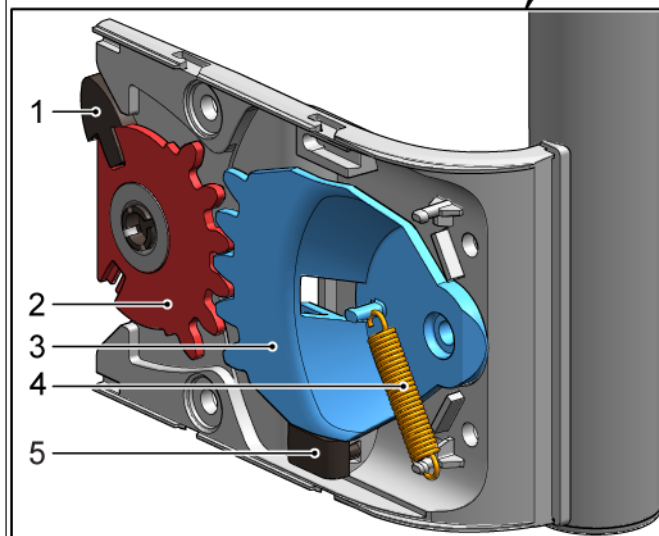

Namještanje podkomponenti ručke easy opening handle za postavljanje desne strane vrata opisano je u uputama za postavljanje.

- ▶ Postavite obratnim redoslijedom.

## 4.4 Zamjena gornjeg zgloba vrata

### Specijalni alati:

 Nastavak Torx TX20      6,3 mm (1/4")      [00340865]

	<b>⚠ UPOZORENJE</b>
	<b>Teški, veliki uređaji!</b> Ozljede leđa i kralježnice ▶ Uklanjanje vrata uređaja smiju obavljati samo obučeni stručnjaci. ▶ Za pomicanje uređaja potrebne su dvije osobe. ▶ Koristite samo prikladan alat i opremu.

	<b>⚠ OPREZ</b>
	<b>Oštri rubovi!</b> Porezotine ▶ Nosite zaštitne rukavice.

	<b>⚠ UPOZORENJE</b>
	<b>Isklizavanje nagnutih uređaja!</b> Puknuća kostiju / ozljede od prignječenja ▶ Osigurajte uređaje od isklizavanja.

	<b>⚠ OPREZ</b>
	<b>Opasnost od padanja dijelova zbog otpuštenih vijaka!</b> Ozljeda od dijelova koji padaju. ▶ Osigurajte sastavne dijelove od pada.

	<b>POZOR!</b>
	<b>Opasnost od padanja dijelova zbog otpuštenih vijaka!</b> Oštećenje drugih dijelova uređaja ili objekta klijenta, npr. poda. ▶ Osigurajte sastavne dijelove od pada.

### Zahtjev:

- ✔ Uređaj je isključen iz napajanja.
- ✔ Unutarnja oprema uređaja je uklonjena.

## 4.4.1 Uklanjanje zgloba vrata

1. Postavite uređaj na poledinu.

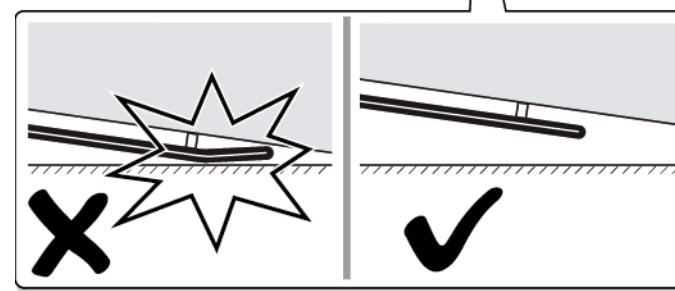
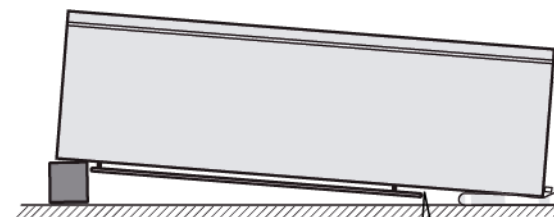
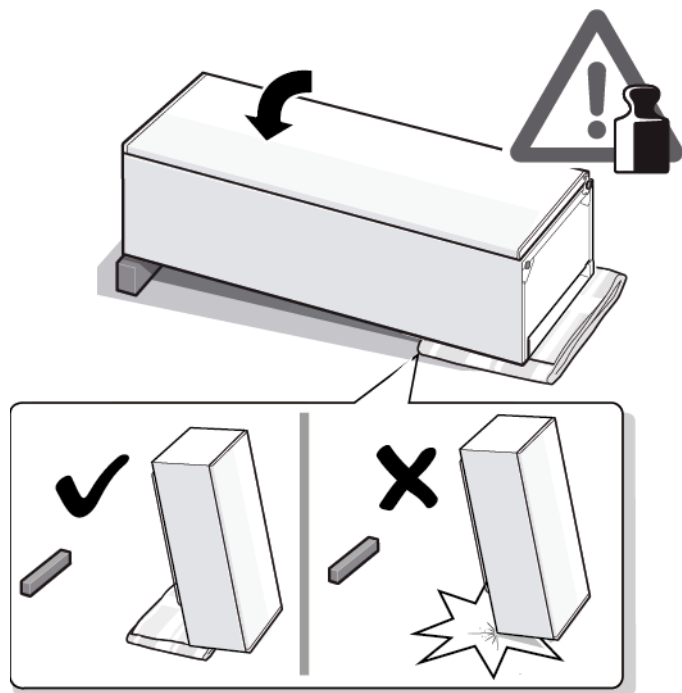

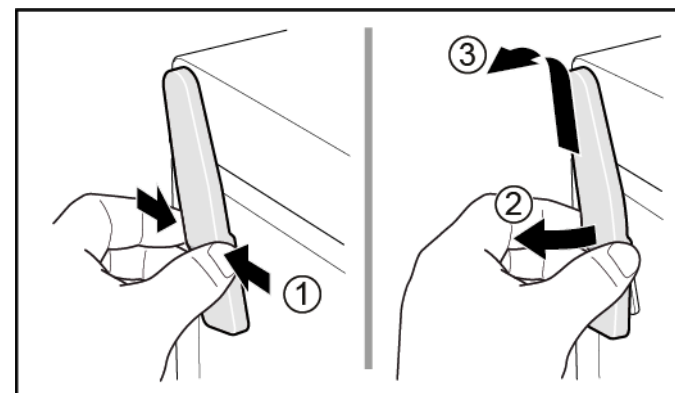

1. Pritisnite poklopac gornjeg zgloba s obje strane (1).
2. Izvadite poklopac gornjeg zgloba (2).
3. Uklonite poklopac gornjeg zgloba (3).

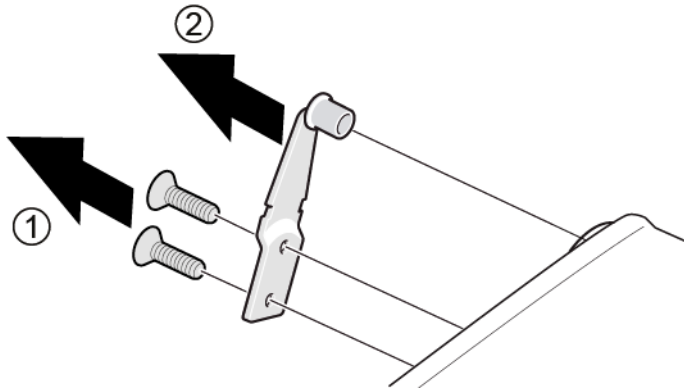

## Popravak

3. 1. Odvijte dva vijka (1).
2. Uklonite gornji zglob (2).



 Gornji zglob vrata je uklonjen.

### 4.4.2 Postavljanje zgloba vrata

- ▶ Postavite obratnim redoslijedom.

## 4.5 Zamjena gornjeg zgloba vrata (vrata sa zaslonom)

### Specijalni alati:

 Nastavak Torx TX20      6,3 mm (1/4")      [00340865]

	<b>⚠ UPOZORENJE</b>
	<p><b>Teški, veliki uređaji!</b> Ozljede leđa i kralježnice</p> <ul style="list-style-type: none"> <li>▶ Uklanjanje vrata uređaja smiju obavljati samo obučeni stručnjaci.</li> <li>▶ Za pomicanje uređaja potrebne su dvije osobe.</li> <li>▶ Koristite samo prikladan alat i opremu.</li> </ul>

	<b>⚠ OPREZ</b>
	<p><b>Oštri rubovi!</b> Porezotine</p> <ul style="list-style-type: none"> <li>▶ Nosite zaštitne rukavice.</li> </ul>

	<b>⚠ UPOZORENJE</b>
	<p><b>Isklizavanje nagnutih uređaja!</b> Puknuća kostiju / ozljede od prignječenja</p> <ul style="list-style-type: none"> <li>▶ Osigurajte uređaje od isklizavanja.</li> </ul>



	<b>⚠ OPREZ</b>
	<p><b>Opasnost od padanja dijelova zbog otpuštenih vijaka!</b> Ozljeda od dijelova koji padaju.</p> <ul style="list-style-type: none"> <li>▶ Osigurajte sastavne dijelove od pada.</li> </ul>

	<b>POZOR!</b>
	<p><b>Opasnost od padanja dijelova zbog otpuštenih vijaka!</b> Oštećenje drugih dijelova uređaja ili objekta klijenta, npr. poda.</p> <ul style="list-style-type: none"> <li>▶ Osigurajte sastavne dijelove od pada.</li> </ul>

	<b>⚠ OPASNOST</b>
	<p><b>Opasnost od strujnog udara zbog dijelova koji provode struju!</b> U slučaju nepravilnog popravka može doći do opasnosti za život od strujnog udara</p> <ul style="list-style-type: none"> <li>▶ Električne dijelove mora popraviti kvalificirani električar.</li> <li>▶ Nakon popravka provedite sigurnosni test u skladu s VDE 0701 ili nacionalnim propisima.</li> </ul>

	<b>⚠ OPASNOST</b>
	<p><b>Opasnost od strujnog udara zbog dijelova koji provode struju!</b> Smrt od strujnog udara</p> <ul style="list-style-type: none"> <li>▶ Isključite uređaj iz električnog napajanja najmanje 60 sekundi prije izvođenja popravaka.</li> </ul>

### Zahtjev:

-  Uređaj je isključen iz napajanja.
-  Unutarnja oprema uređaja je uklonjena.

## 4.5.1 Uklanjanje zgloba vrata

1. Postavite uređaj na poledinu.

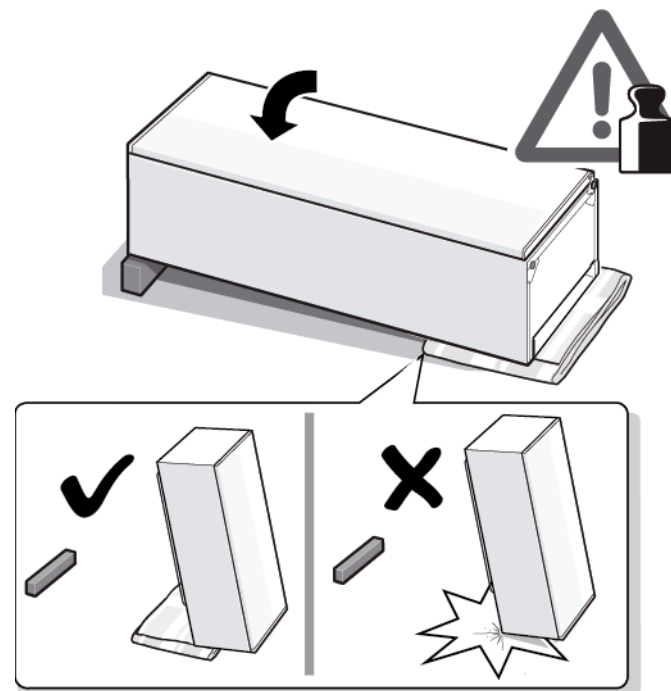

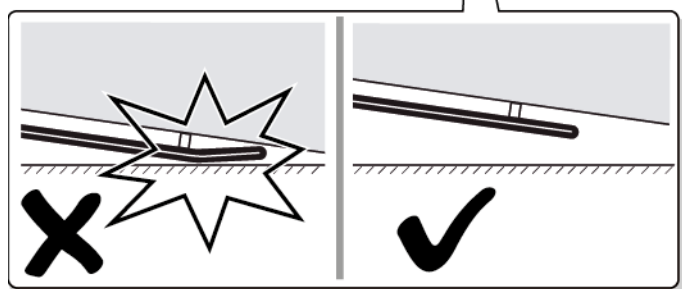
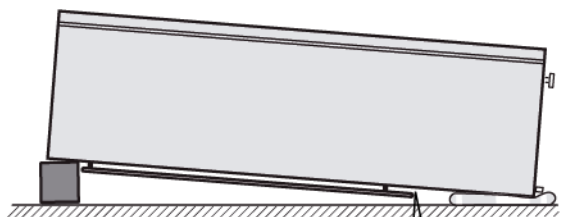

2. 1. Pritisnite poklopac gornjeg zgloba s obje strane (1).
2. Izvadite poklopac gornjeg zgloba (2).
3. Uklonite poklopac gornjeg zgloba (3).

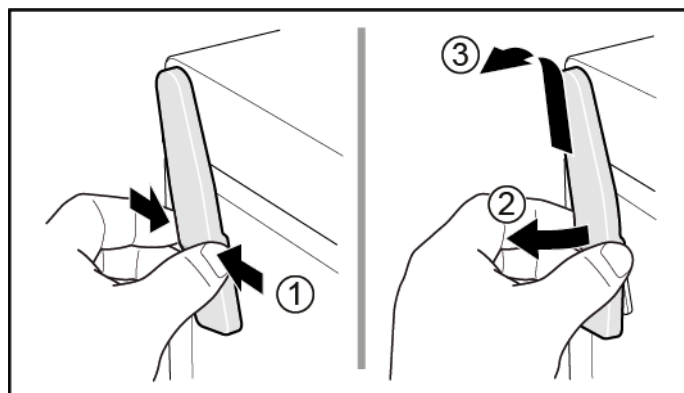

3. 1. Uklonite poklopac kutije za kabele (1).
2. Uklonite zaštitu kabela (2).
3. Odvojite električni priključak (3).
4. Odvijte dva vijka (4).
5. Uklonite gornji zglob (5).

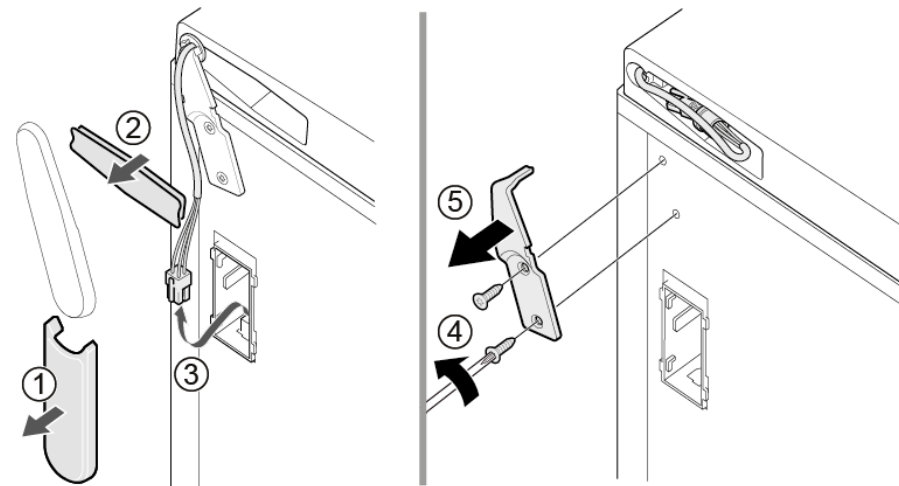

➡ Gornji zglob vrata je uklonjen.

## 4.5.2 Postavljanje zgloba vrata

- ▶ Postavite obratnim redoslijedom.





## 4.6 Zamjena donjeg zgloba vrata

### Specijalni alati:

🔧 Nastavak Torx TX20      6,3 mm (1/4")      [00340865]

	<b>⚠️ UPOZORENJE</b>
<p><b>Teški, veliki uređaji!</b> Ozljede leđa i kralježnice</p> <ul style="list-style-type: none"> <li>▶ Uklanjanje vrata uređaja smiju obavljati samo obučeni stručnjaci.</li> <li>▶ Za pomicanje uređaja potrebne su dvije osobe.</li> <li>▶ Koristite samo prikladan alat i opremu.</li> </ul>	

	<b>⚠️ OPREZ</b>
<p><b>Oštri rubovi!</b> Porezotine</p> <ul style="list-style-type: none"> <li>▶ Nosite zaštitne rukavice.</li> </ul>	

	<b>⚠️ UPOZORENJE</b>
<p><b>Isklizavanje nagnutih uređaja!</b> Puknuća kostiju / ozljede od prignječenja</p> <ul style="list-style-type: none"> <li>▶ Osigurajte uređaje od isklizavanja.</li> </ul>	

	<b>⚠️ OPREZ</b>
<p><b>Opasnost od padanja dijelova zbog otpuštenih vijaka!</b> Ozljeda od dijelova koji padaju.</p> <ul style="list-style-type: none"> <li>▶ Osigurajte sastavne dijelove od pada.</li> </ul>	

	<b>POZOR!</b>
<p><b>Opasnost od padanja dijelova zbog otpuštenih vijaka!</b> Oštećenje drugih dijelova uređaja ili objekta klijenta, npr. poda.</p> <ul style="list-style-type: none"> <li>▶ Osigurajte sastavne dijelove od pada.</li> </ul>	

### Zahtjev:

- ✅ Uređaj je isključen iz napajanja.
- ✅ Unutarnja oprema uređaja je uklonjena.
- ✅ Uređaj je postavljen na poledinu.
- ✅ [Gornji je zglob uklonjen. →38](#)

### 4.6.1 Zamjena donjeg zgloba vrata

1. Uklonite vrata.

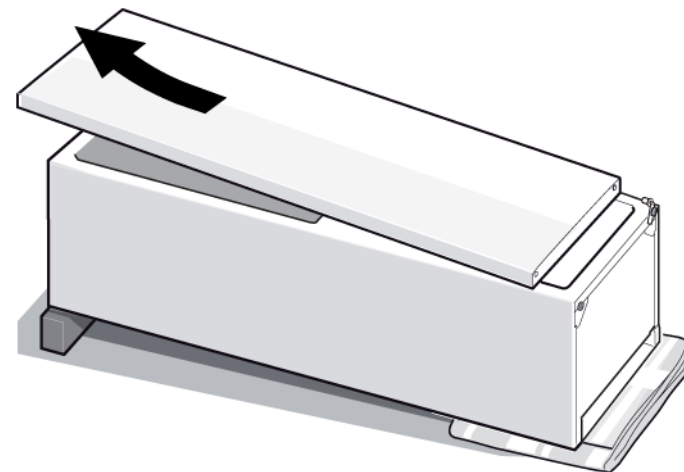

2. 1. Odvijte vijak (1).
2. Izvadite donji zglob (2).
3. Uklonite donji zglob (3).

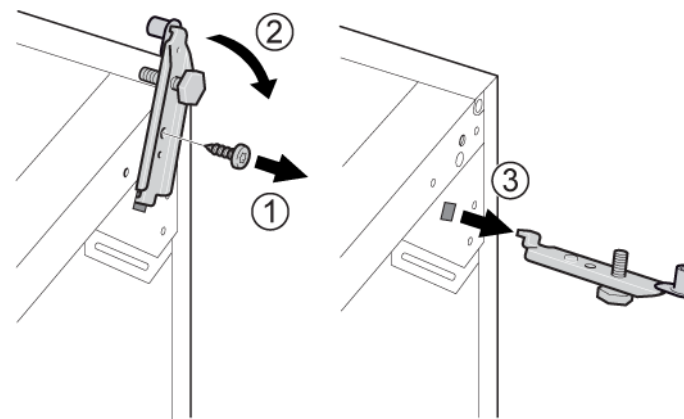

- ➡ Donji je zglob uklonjen.

### 4.6.2 Postavljanje donjeg zgloba vrata

- ▶ Postavite obratnim redoslijedom.

## 4.7 Zamjena police

### Zahtjev:

- ✔ Vrata su otvorena.

### 4.7.1 Uklanjanje police

- ▶ Izvucite policu.

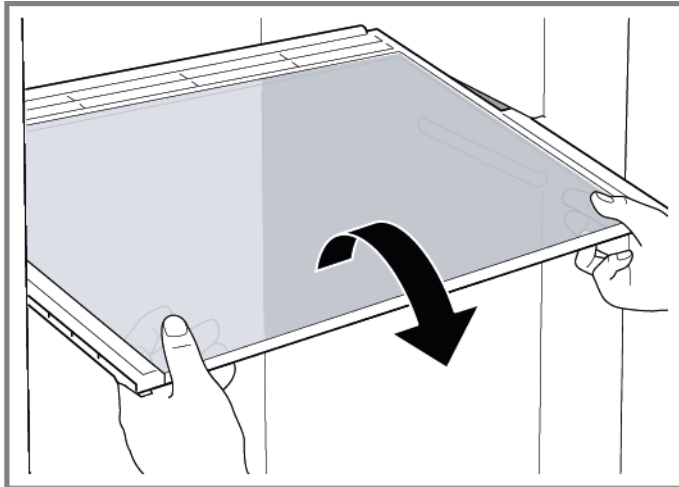

- ➡ Polica je uklonjena.

### 4.7.2 Postavljanje police

- ▶ Postavite obratnim redoslijedom.

## 4.8 Zamjena spremnika za zamrznute namirnice

### Zahtjev:

- ✔ Vrata su otvorena.

### 4.8.1 Uklanjanje spremnika za zamrznute namirnice

- ▶ 1. Potpuno izvucite spremnik za zamrznute namirnice (1).
- ▶ 2. Uklonite spremnik za zamrznute namirnice (2).

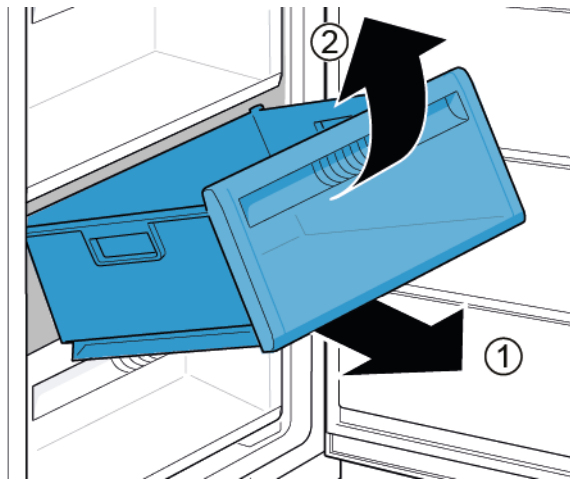

- ➡ Spremnik za zamrznute namirnice je uklonjen.

### 4.8.2 Postavljanje spremnika za zamrznute namirnice

- ▶ Postavite obratnim redoslijedom.

## 4.9 Zamjena ledomata

### Zahtjev:

- ✔ Vrata su otvorena.

### 4.9.1 Uklanjanje ledomata

- ▶ 1. Izvucite policu spremnika za zamrznute namirnice s ledomatom (1).
- ▶ 2. Otpustite kuke (2).
- ▶ 3. Uklonite ledomat (3).

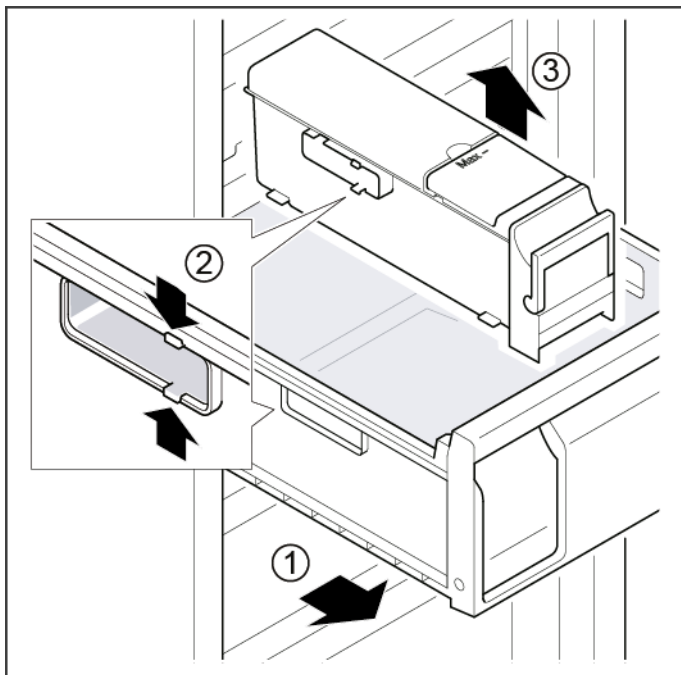

➡ Ledomat je uklonjen.

### 4.9.2 Postavljanje ledomata

- ▶ Postavite obratnim redoslijedom.

## 4.10 Zamjena LED gornjeg svjetla

### Specijalni alati:

- 🔧 Odvijač s utorom      Nož 2,4 mm x 0,4 mm x 60 mm, u kompletu [00341820]

	Uređaj ima svjetlo LED koje ne zahtijeva održavanje. Ta svjetla smije popravljati samo osoblje iz službe za korisnike ili ovlaštene tehničari!
---	--

	<b>⚠️ OPASNOST</b> <b>Opasnost od strujnog udara zbog dijelova koji provode struju!</b> U slučaju nepravilnog popravka može doći do opasnosti za život od strujnog udara <ul style="list-style-type: none"><li>▶ Električne dijelove mora popraviti kvalificirani električar.</li><li>▶ Nakon popravka provedite sigurnosni test u skladu s VDE 0701 ili nacionalnim propisima.</li></ul>
--	---

	<b>⚠️ OPASNOST</b> <b>Opasnost od strujnog udara zbog dijelova koji provode struju!</b> Smrt od strujnog udara <ul style="list-style-type: none"><li>▶ Isključite uređaj iz električnog napajanja najmanje 60 sekundi prije izvođenja popravaka.</li></ul>
--	--

	<b>⚠️ OPREZ</b> <b>Oštri rubovi!</b> Porezotine <ul style="list-style-type: none"><li>▶ Nosite zaštitne rukavice.</li></ul>
---	---

### Zahtjev:

- ✔ Uređaj je isključen iz napajanja.
- ✔ Vrata su otvorena.
- ✔ Gornja unutarnja oprema je uklonjena.

### 4.10.1 Uklanjanje LED svjetla

1. Pomaknite LED svjetlo ulijevo.



-  Električni priključak LED svjetla je odvojen.

2. Otpustite kuke LED svjetla.

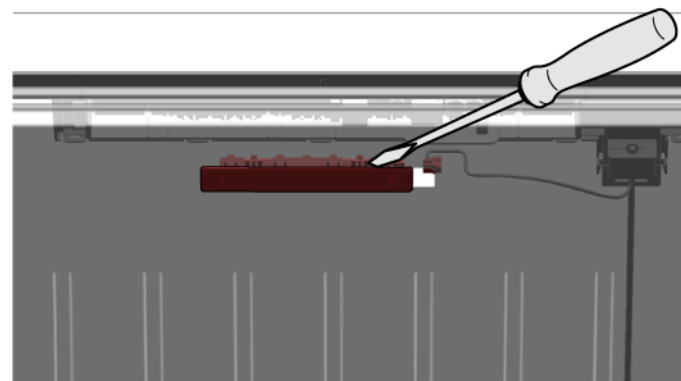

3. Uklonite LED svjetlo tako da ga pomaknete prema naprijed.

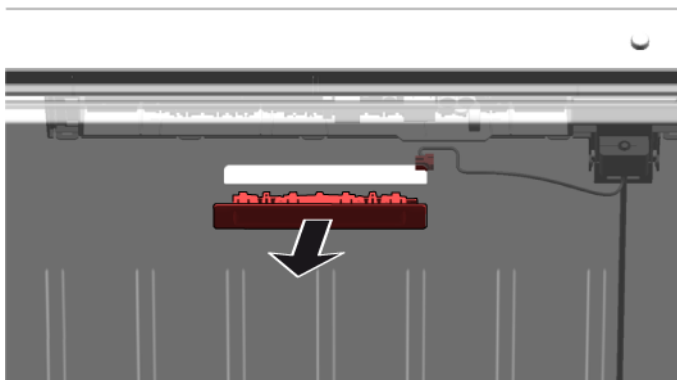





- ➔ LED svjetlo je uklonjeno.

### 4.10.2 Postavljanje gornjeg LED svjetla

- ▶ Postavite obratnim redoslijedom.

# Poznámky k opravě - Mraznička

 <b>O tomto dokumentu</b> .....	<b>48</b>
1.1 Důležité informace .....	48
1.1.1 Účel .....	48
1.2 Vysvětlení symbolů .....	48
1.2.1 Úroveň nebezpečí .....	48
1.2.2 Symboly nebezpečí .....	48
1.2.3 Struktura výstrah .....	49
1.2.4 Obecné symboly .....	49
 <b>Bezpečnost</b> .....	<b>50</b>
2.1 Všeobecné bezpečnostní pokyny .....	50
2.1.1 Všechny domácí spotřebiče .....	50
 <b>Nástroje a pomůcky</b> .....	<b>51</b>
 <b>Oprava</b> .....	<b>52</b>
4.1 Výměna těsnění dvířek .....	52
4.1.1 Vyjmutí těsnění dvířek .....	52
4.1.2 Montáž těsnění dvířek .....	52
4.2 Výměna madla dvířek .....	55
4.2.1 Vyjmutí madla dvířek .....	55
4.2.2 Montáž madla dvířek .....	55
4.3 Výměna Easy opening handle .....	56
4.3.1 Vyjmutí Easy opening handle .....	56
4.3.2 Montáž Easy opening handle .....	56
4.4 Výměna horního závěsu dvířek .....	57
4.4.1 Odstranění závěsu dvířek .....	57
4.4.2 Montáž závěsu dvířek .....	59
4.5 Výměna horního závěsu dvířek (dvířka s ukazatelem) .....	60
4.5.1 Odstranění závěsu dvířek .....	61
4.5.2 Montáž závěsu dvířek .....	62
4.6 Výměna dolního závěsu dvířek .....	63
4.6.1 Výměna dolního závěsu dvířek .....	63
4.6.2 Montáž spodního závěsu dvířek .....	64
4.7 Výměna odkládací plochy .....	65
4.7.1 Vyjmutí odkládací plochy .....	65
4.7.2 Montáž odkládací plochy .....	65

4.8 Výměna zásobníku na zmrazené potraviny .....	66
4.8.1 Vyjmutí zásobníku na zmrazené potraviny .....	66
4.8.2 Montáž zásobníku na zmrazené potraviny .....	66
4.9 Výměna výrobku ledu .....	67
4.9.1 Vyjmutí výrobku ledu .....	67
4.9.2 Montáž výrobku ledu .....	67
4.10 Výměna LED horního osvětlení .....	68
4.10.1 Vyjmutí LED osvětlení .....	68
4.10.2 Montáž horního LED osvětlení .....	69

# **i** O tomto dokumentu

## 1.1 Důležité informace

### 1.1.1 Účel

Tyto pokyny k opravě pomáhají spotřebiteli při vlastnoruční opravě spotřebičů v souladu s platnými předpisy o ekodesignu (platnými k 03/2021).



Obsahují informace o výměně některých náhradních dílů včetně příslušných výstrah a nebezpečí.

V případě dotazů se obraťte na náš zákaznický servis. Za škody ručíme pouze v případě, že budou správně dodrženy pokyny k opravě.

## 1.2 Vysvětlení symbolů

### 1.2.1 Úroveň nebezpečí

Jednotlivé úrovně výstrah se skládají ze symbolu a signálního slova. Signální slova uvádějí závažnost nebezpečí.





Úroveň výstrahy	Význam
 <b>NEBEZPEČÍ</b>	Nedodržení výstražného upozornění způsobí smrt nebo vážná zranění.
 <b>VÝSTRAHA</b>	Nedodržení výstražného upozornění může způsobit smrt nebo vážná zranění.
 <b>POZOR</b>	Nedodržení výstražného upozornění může způsobit lehká zranění.
<b>POZOR!</b>	Nedodržení výstražného upozornění může způsobit škody na majetku.

Tabulka 1: Úroveň nebezpečí

### 1.2.2 Symboly nebezpečí



Symboly nebezpečí jsou symbolická znázornění určující druh nebezpečí.

V tomto dokumentu jsou použity následující symboly nebezpečí:

Symbol nebezpečí	Význam
	Obecné výstražné upozornění
	Nebezpečí vycházející z elektrického napětí
	Nebezpečí výbuchu
	Nebezpečí pořezání
	Nebezpečí rozdrcení





## O tomto dokumentu

Symbol nebezpečí	Význam
	Nebezpečí spojené s horkými povrchy
	Nebezpečí vycházející ze silného elektromagnetického pole
	Nebezpečí z neionizujícího záření

Tabulka 2: Symboly nebezpečí

### 1.2.3 Struktura výstrah

Výstrahy použité v tomto dokumentu mají standardizovaný vzhled a strukturu.



	<div style="background-color: red; color: white; padding: 2px; text-align: center;"> <b>NEBEZPEČÍ</b></div> <p><b>Typ a zdroj nebezpečí!</b> Možné důsledky nedodržení výstražného upozornění.</p> <ul style="list-style-type: none"> <li>▶ Opatření a zákazy eliminující nebezpečí.</li> </ul>
--	--





Následující příklad ukazuje výstrahu, která varuje před zásahem elektrickým proudem při dotyku dílů pod proudem. Je uvedeno opatření pro zabránění rizika.

	<div style="background-color: red; color: white; padding: 2px; text-align: center;"> <b>NEBEZPEČÍ</b></div> <p><b>Nebezpečí úrazu elektrickým proudem při dotyku dílů pod proudem!</b> Usmrcení elektrickým proudem</p> <ul style="list-style-type: none"> <li>▶ Odpojte spotřebič od přívodu elektrického proudu alespoň 60 sekund před zahájením opravy.</li> </ul>
---	--

### 1.2.4 Obecné symboly

V tomto dokumentu jsou použity následující obecné symboly:

Obecný symbol	Význam
	Uvedení zvláštního tipu (text nebo grafické vyjádření)
	Uvedení jednoduchého tipu (pouze text)
	Uvedení odkazu k videonávodu

Obecný symbol	Význam
	Uvedení požadovaných nástrojů
	Uvedení požadovaných podmínek
	Uvedení podmínky (když, pak atd.)
	Uvedení výsledku
[Start]	Uvedení klávesy nebo tlačítka
[00123456]	Uvedení čísla materiálu
Status	Uvedení zobrazeného textu / okna (na ukazateli spotřebiče)

Tabulka 3: Obecné symboly

## **2.1 Všeobecné bezpečnostní pokyny**

### **2.1.1 Všechny domácí spotřebiče**

#### **Nebezpečí úrazu elektrickým proudem při dotyku dílů pod proudem!**

- Chyby při opravě elektrických součástí mohou vést k úrazu elektrickým proudem!
- Odpojte spotřebič ze sítě alespoň 60 sekund před zahájením prací.
- Po opravě nechte provést bezpečnostní zkoušku podle VDE 0701 nebo specifických předpisů dané země.

#### **Nebezpečí poranění o ostré hrany!**

- Používejte ochranné rukavice.

#### **Nebezpečí rozdrčení během opravy, údržby, odstranění závad a servisu těžkými a pohyblivými součástmi**

- Používejte bezpečnostní obuv.
- Zajistěte těžké součásti před pádem.
- Nesahejte na pohyblivé součásti.



#### **Nebezpečí z hlediska bezpečnosti / funkce spotřebiče!**

- Používejte pouze originální náhradní díly.

#### **Nebezpečí poškození elektrostaticky citlivých součástí (elektrostatický výboj)!**

- Nedotýkejte se modulů, včetně přípojek a vodičů.

## Nástroje a pomůcky

Označení	Detaily	Snímky
Ochranná tkanina [00342013]	60 cm x 50 cm	
Šroubovák Phillips PH2		
Torx Bit TX20 [00340865]	6,3 mm (1/4")	
Plochý šroubovák	Čepel 2,4 mm x 0,4 mm x 60 mm, v sadě [00341820]	

## 4.1 Výměna těsnění dvířek

### Požadavek:

- ✔ Dvířka jsou otevřená.

### 4.1.1 Vyjmutí těsnění dvířek

1. Uvolněte těsnění dvířek z drážky v pravém a levém rohu.

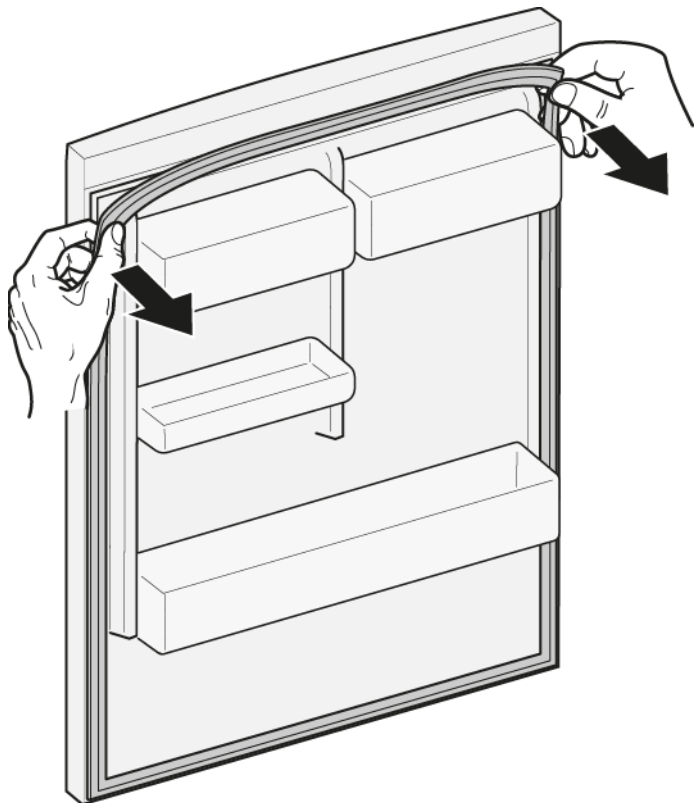

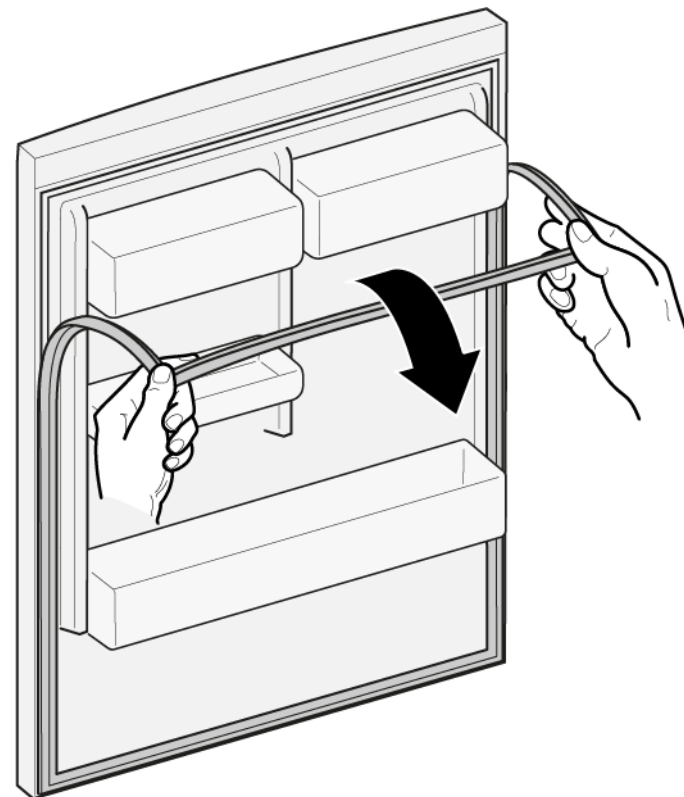

2. Vytáhněte těsnění z drážky.



- ➡ Těsnění dvířek je vyjmuté.

### 4.1.2 Montáž těsnění dvířek

	Nové těsnění dvířek může mít trochu jinou šířku než původní těsnění. Dovření dvířek ani dlouhodobá funkce tím nebudou ovlivněny.
	Pokud má spotřebič nastavitelné závěsy nebo nástavce závěsů, můžete dovření dvířek následně upravit.
	Malé boční otvory v těsnění dvířek jsou funkční (slouží pro přívod vzduchu). Nejsou vadou výrobku.

1. Zkontrolujte, zda není poškozena drážka těsnění.

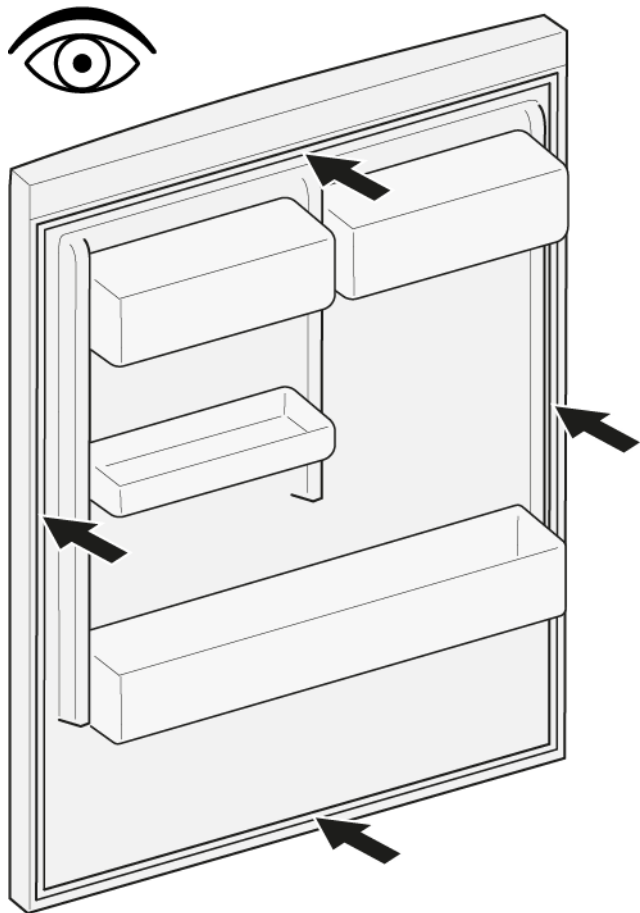

4. Zatlačte horní a dolní rohy těsnění do drážky.

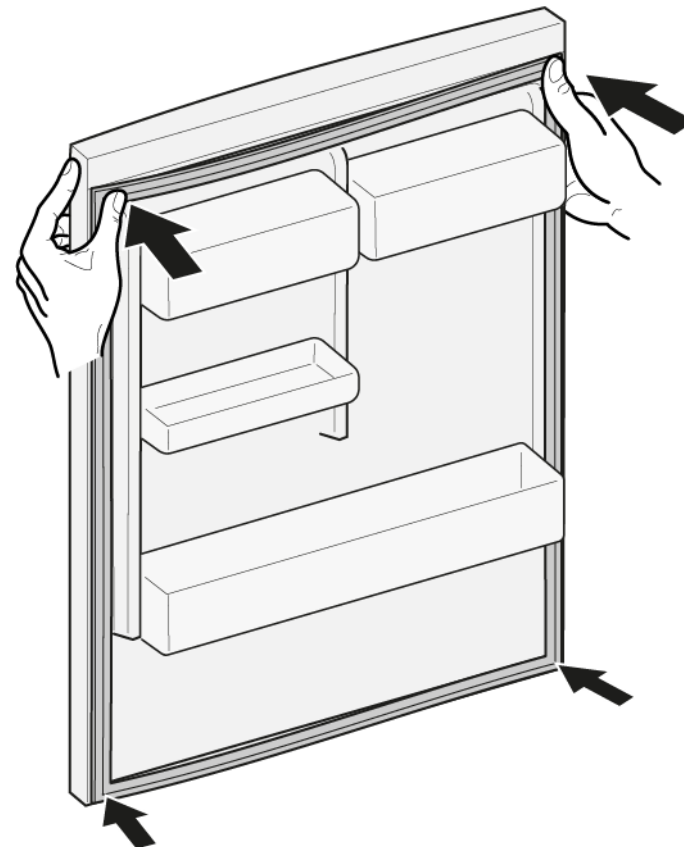

2.  Pokud je drážka těsnění poškozená,  
- kontaktujte zákaznický servis.

3.  Lehká deformace těsnění dvířek je normální a nemá vliv na jeho funkci. Před vložením do spotřebiče doporučujeme těsnění narovnat.

Těsnění zahřejte fénem nebo horkou vodou a manuálně upravte jeho tvar.

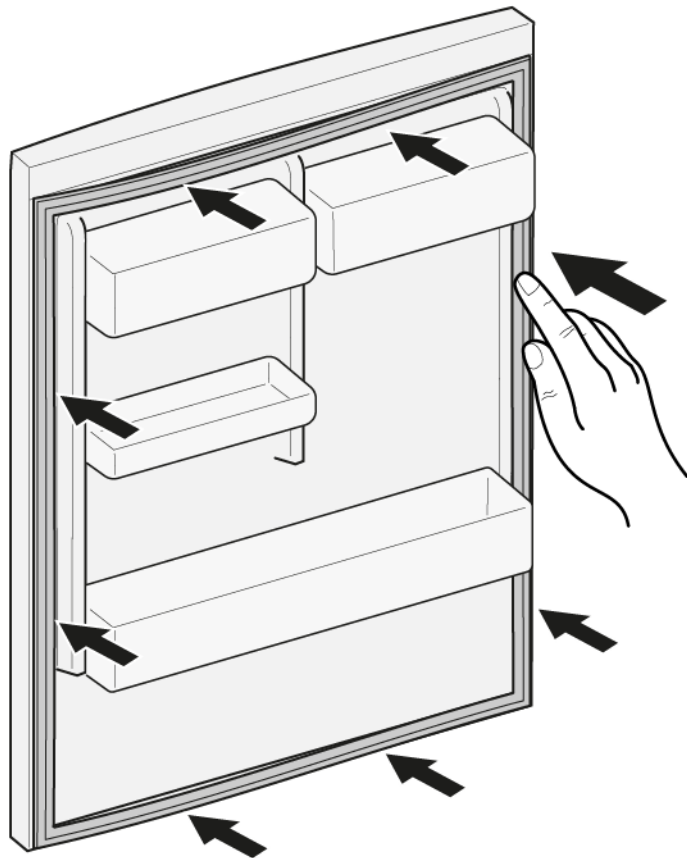

5. Postupně zatlačte do drážky celé těsnění.





 Těsnění dvířek je namontované.

## 4.2 Výměna madla dvířek

### Speciální nástroje:

-  Torx Bit TX20 6,3 mm (1/4") [00340865]
-  Plochý šroubovák Čepel 10 mm x 1,6 mm x 200 mm

### Požadavek:

-  Spotřebič je odpojený od přívodu elektrické energie.
-  Dvířka jsou otevřená.

### 4.2.1 Vyjmutí madla dvířek

- ▶ 1. Odstraňte dvě krytky šroubů (1).
- ▶ 2. Vyšroubujte dva šrouby (2).
- ▶ 3. Vyjměte madlo dvířek (3).

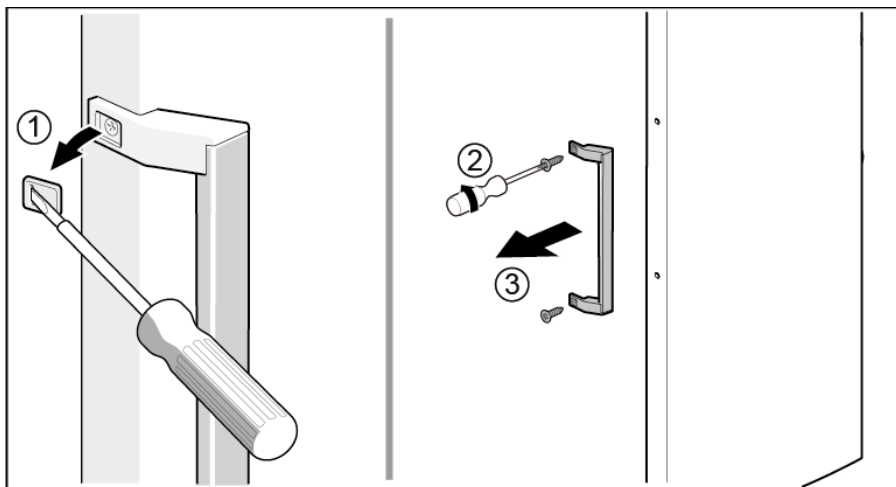

-  Madlo dvířek je vyjmuté.

### 4.2.2 Montáž madla dvířek

- ▶ Montáž provedte v opačném sledu.

## 4.3 Výměna Easy opening handle

### Speciální nástroje:

- Šroubovák Phillips PH2

### Požadavek:

- Spotřebič je odpojený od přívodu elektrické energie.
- Dvířka jsou otevřená.

### 4.3.1 Vyjmutí Easy opening handle

1. Odstraňte kryt Easy opening handle (1).
2. Vyšroubujte dva šrouby (2).

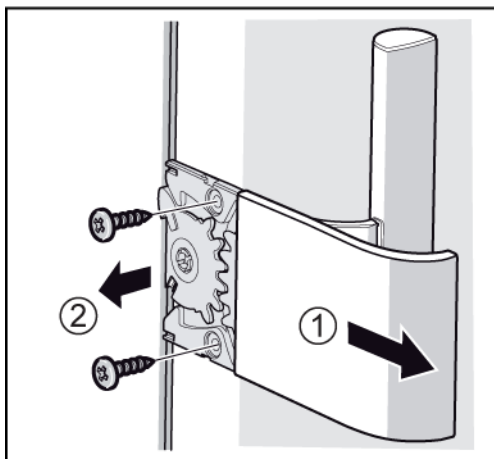

- Easy opening handle je odstraněné.

### 4.3.2 Montáž Easy opening handle

Mechanismus Easy opening handle musí být před montáží správně seřazený.

Na obrázku je znázorněno správné uspořádání táhla (1), ozubeného kvadrantu (2) a (3), pružiny (4) a dorazu (5) pro levostrannou montáž dvířek.

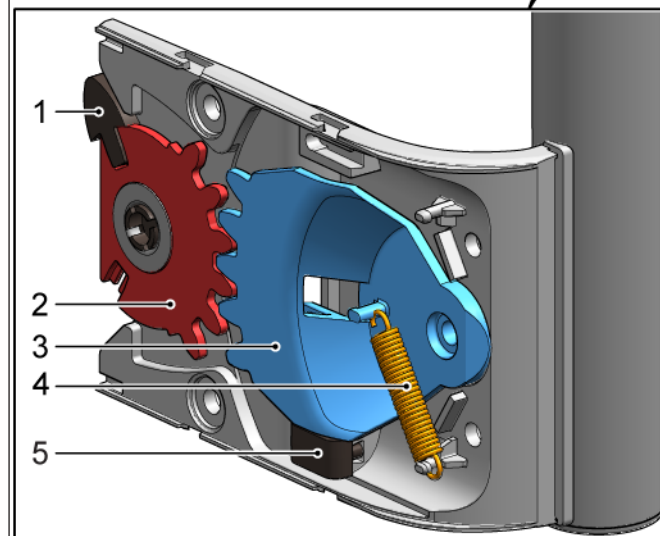

Uspořádání jednotlivých komponentů Easy opening handle pro pravostrannou montáž je popsáno v dokumentu „Návod k montáži“.

- Montáž proveďte v opačném sledu.



## 4.4 Výměna horního závěsu dvířek

### Speciální nástroje:

 Torx Bit TX20                      6,3 mm (1/4")                      [00340865]

	<b>⚠ VÝSTRAHA</b>
	<b>Těžké, objemné spotřebiče!</b> Poranění zad a svalů <ul style="list-style-type: none"><li>▶ Odstranění dvířek spotřebiče by měl provádět výhradně školený odborník.</li><li>▶ Pro manipulaci se spotřebičem jsou nutní dva lidé.</li><li>▶ Použijte pouze vhodné nástroje a zařízení.</li></ul>

	<b>⚠ POZOR</b>
	<b>Ostré hrany!</b> Nebezpečí řezných poranění <ul style="list-style-type: none"><li>▶ Používejte ochranné rukavice.</li></ul>

	<b>⚠ VÝSTRAHA</b>
	<b>Sklouznutí nakloněných spotřebičů!</b> Zlomeniny / poranění rozdrcením <ul style="list-style-type: none"><li>▶ Zajistěte spotřebiče proti sklouznutí.</li></ul>

	<b>⚠ POZOR</b>
	<b>Nebezpečí padajících dílů kvůli uvolněným šroubům!</b> Poranění padajícími díly. <ul style="list-style-type: none"><li>▶ Zajistěte jednotlivé součásti před pádem.</li></ul>

	<b>POZOR!</b>
	<b>Nebezpečí padajících dílů kvůli uvolněným šroubům!</b> Poškození jiných částí spotřebiče nebo prvků domácnosti zákazníka, např. podlahy. <ul style="list-style-type: none"><li>▶ Zajistěte jednotlivé součásti před pádem.</li></ul>

### Požadavek:

- ✔ Spotřebič je odpojený od přívodu elektrické energie.
- ✔ Vnitřní kování spotřebiče je odstraněno.

## 4.4.1 Odstranění závěsu dvířek

1. Položte spotřebič na zadní stranu.

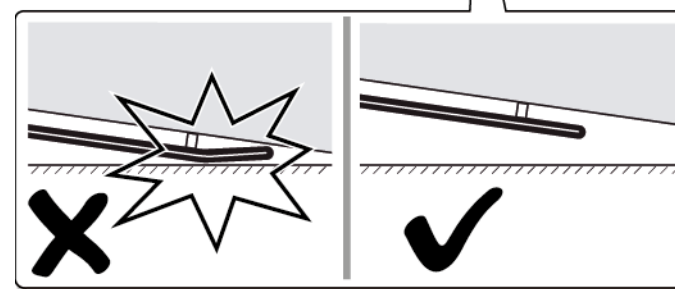
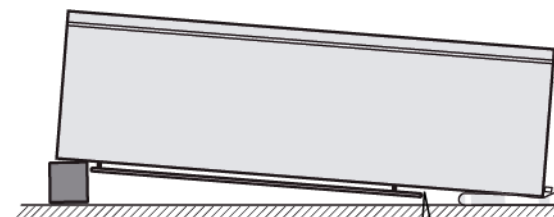
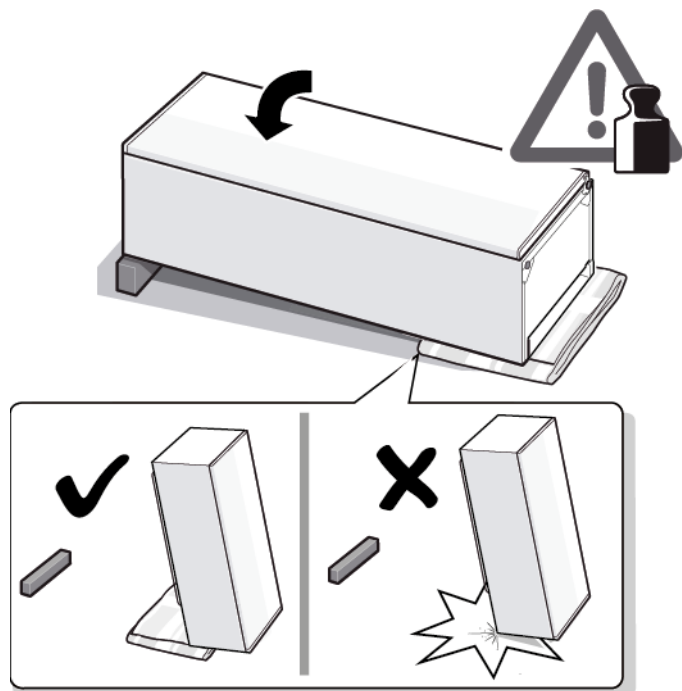

2. 1. Na obou stranách stiskněte kryt horního závěsu (1).  
2. Vysuňte kryt horního závěsu (2).  
3. Odstraňte kryt horního závěsu (3).

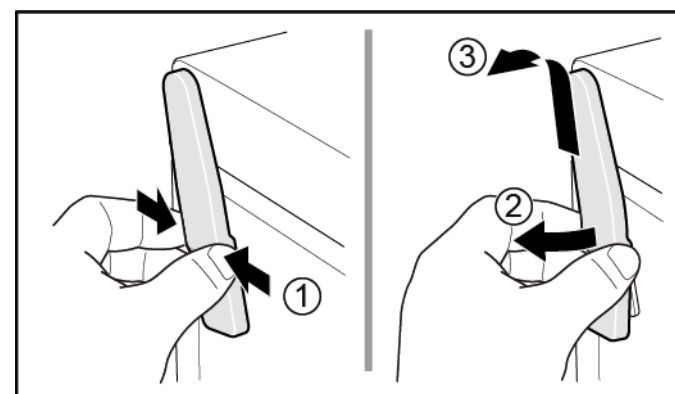

## Oprava

3. 1. Vyšroubujte dva šrouby (1).
2. Vyměňte horní závěs (2).

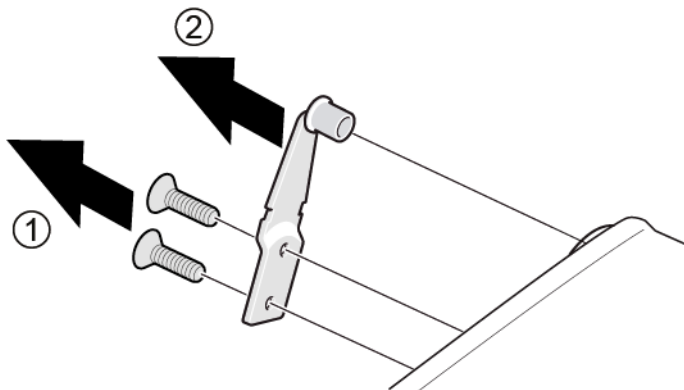

 Horní závěs dvířek je vyjmutý.

### 4.4.2 Montáž závěsu dvířek

- ▶ Montáž proveďte v opačném sledu.

## 4.5 Výměna horního závěsu dvířek (dvířka s ukazatelem)

Speciální nástroje:

 Torx Bit TX20                      6,3 mm (1/4")                      [00340865]

	<b>⚠ VÝSTRAHA</b>
	<p><b>Těžké, objemné spotřebiče!</b> Poranění zad a svalů</p> <ul style="list-style-type: none"> <li>▶ Odstranění dvířek spotřebiče by měl provádět výhradně školený odborník.</li> <li>▶ Pro manipulaci se spotřebičem jsou nutní dva lidé.</li> <li>▶ Použijte pouze vhodné nástroje a zařízení.</li> </ul>

	<b>⚠ POZOR</b>
	<p><b>Ostré hrany!</b> Nebezpečí řezných poranění</p> <ul style="list-style-type: none"> <li>▶ Používejte ochranné rukavice.</li> </ul>

	<b>⚠ VÝSTRAHA</b>
	<p><b>Sklouznutí nakloněných spotřebičů!</b> Zlomeniny / poranění rozdrcením</p> <ul style="list-style-type: none"> <li>▶ Zajistěte spotřebiče proti sklouznutí.</li> </ul>



	<b>⚠ POZOR</b>
	<p><b>Nebezpečí padajících dílů kvůli uvolněným šroubům!</b> Poranění padajícími díly.</p> <ul style="list-style-type: none"> <li>▶ Zajistěte jednotlivé součásti před pádem.</li> </ul>

	<b>POZOR!</b>
	<p><b>Nebezpečí padajících dílů kvůli uvolněným šroubům!</b> Poškození jiných částí spotřebiče nebo prvků domácnosti zákazníka, např. podlahy.</p> <ul style="list-style-type: none"> <li>▶ Zajistěte jednotlivé součásti před pádem.</li> </ul>

	<b>⚠ NEBEZPEČÍ</b>
	<p><b>Nebezpečí úrazu elektrickým proudem při dotyku dílů pod proudem!</b> V případě neodborné opravy hrozí nebezpečí smrtelného úrazu elektrickým proudem</p> <ul style="list-style-type: none"> <li>▶ Opravu elektrického zařízení smí provádět jen kvalifikovaný elektrikář.</li> <li>▶ Po opravě nechte provést bezpečnostní zkoušku podle VDE 0701 nebo specifických předpisů dané země.</li> </ul>

	<b>⚠ NEBEZPEČÍ</b>
	<p><b>Nebezpečí úrazu elektrickým proudem při dotyku dílů pod proudem!</b> Usmrcení elektrickým proudem</p> <ul style="list-style-type: none"> <li>▶ Odpojte spotřebič od přívodu elektrického proudu alespoň 60 sekund před zahájením opravy.</li> </ul>

**Požadavek:**

-  Spotřebič je odpojený od přívodu elektrické energie.
-  Vnitřní kování spotřebiče je odstraněno.

### 4.5.1 Odstranění závěsu dvířek

1. Položte spotřebič na zadní stranu.

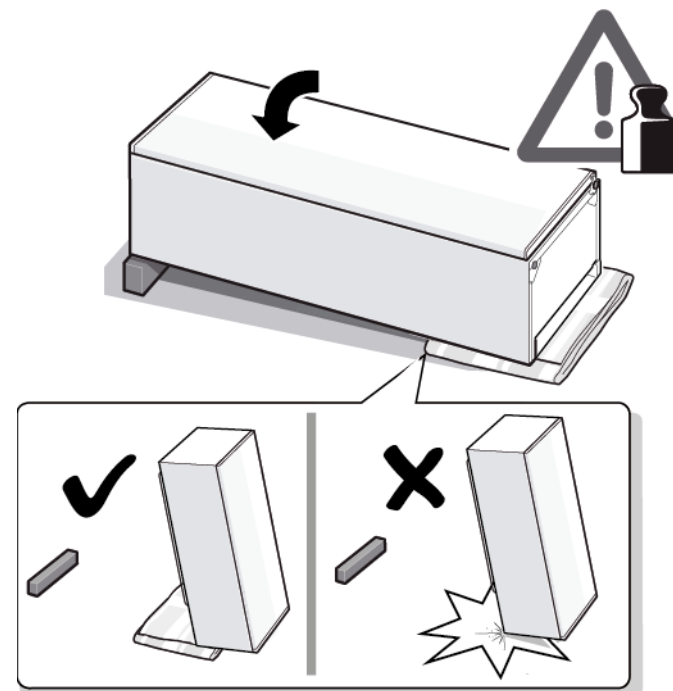

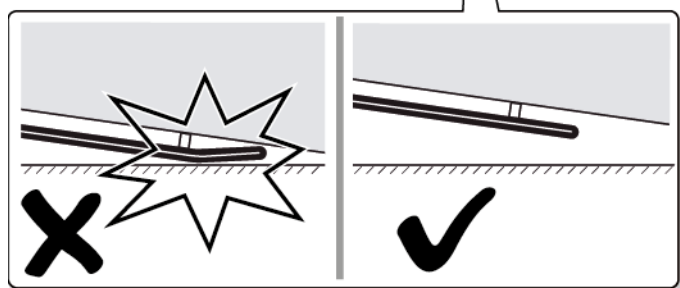
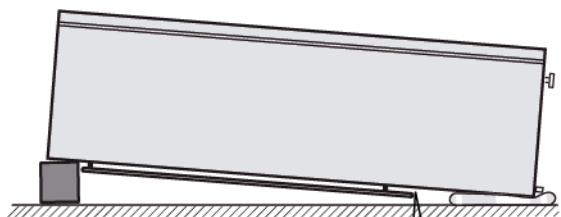

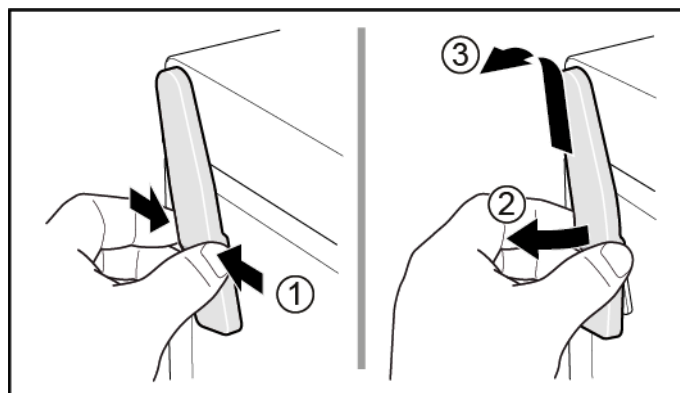

2. 1. Na obou stranách stiskněte kryt horního závěsu (1).
2. Vysuňte kryt horního závěsu (2).
3. Odstraňte kryt horního závěsu (3).

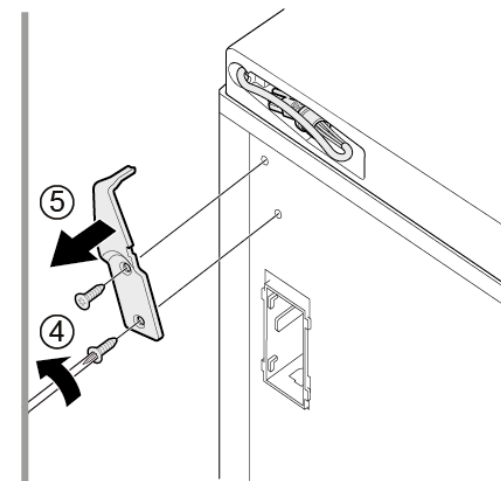
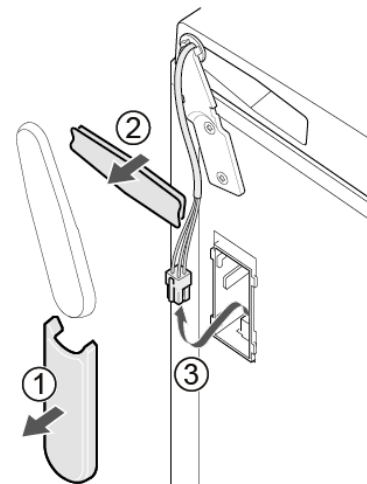

3. 1. Odstraňte kryt kabelové skříně (1).
2. Odstraňte ochranu kabelu (2).
3. Odpojte elektrické připojení (3).
4. Vyšroubujte dva šrouby (4).
5. Vyměňte horní závěs (5).



 Horní závěs dvířek je vyjmutý.

#### 4.5.2 Montáž závěsu dvířek

- ▶ Montáž proveďte v opačném sledu.

## 4.6 Výměna dolního závěsu dvířek

Speciální nástroje:

Torx Bit TX20 6,3 mm (1/4") [00340865]

	<b>⚠ VÝSTRAHA</b>
	<p><b>Těžké, objemné spotřebiče!</b> Poranění zad a svalů</p> <ul style="list-style-type: none"> <li>▶ Odstranění dvířek spotřebiče by měl provádět výhradně školený odborník.</li> <li>▶ Pro manipulaci se spotřebičem jsou nutní dva lidé.</li> <li>▶ Použijte pouze vhodné nástroje a zařízení.</li> </ul>

	<b>⚠ POZOR</b>
	<p><b>Ostré hrany!</b> Nebezpečí řezných poranění</p> <ul style="list-style-type: none"> <li>▶ Používejte ochranné rukavice.</li> </ul>

	<b>⚠ VÝSTRAHA</b>
	<p><b>Sklouznutí nakloněných spotřebičů!</b> Zlomeniny / poranění rozdrcením</p> <ul style="list-style-type: none"> <li>▶ Zajistěte spotřebiče proti sklouznutí.</li> </ul>

	<b>⚠ POZOR</b>
	<p><b>Nebezpečí padajících dílů kvůli uvolněným šroubům!</b> Poranění padajícími díly.</p> <ul style="list-style-type: none"> <li>▶ Zajistěte jednotlivé součásti před pádem.</li> </ul>

	<b>POZOR!</b>
	<p><b>Nebezpečí padajících dílů kvůli uvolněným šroubům!</b> Poškození jiných částí spotřebiče nebo prvků domácnosti zákazníka, např. podlahy.</p> <ul style="list-style-type: none"> <li>▶ Zajistěte jednotlivé součásti před pádem.</li> </ul>

Požadavek:

- ✔ Spotřebič je odpojený od přívodu elektrické energie.
- ✔ Vnitřní kování spotřebiče je odstraněno.
- ✔ Spotřebič leží na zadní straně.

✔ [Horní závěs je vyjmutý. →60](#)

### 4.6.1 Výměna dolního závěsu dvířek

1. Odstraňte dvířka.

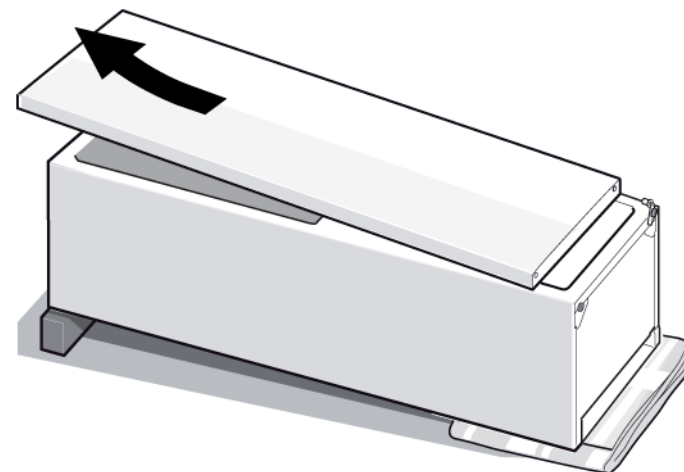

- 2.
1. Vyšroubujte šrouby (1).
  2. Vytočte spodní závěs (2).
  3. Vyjměte spodní závěs (3).

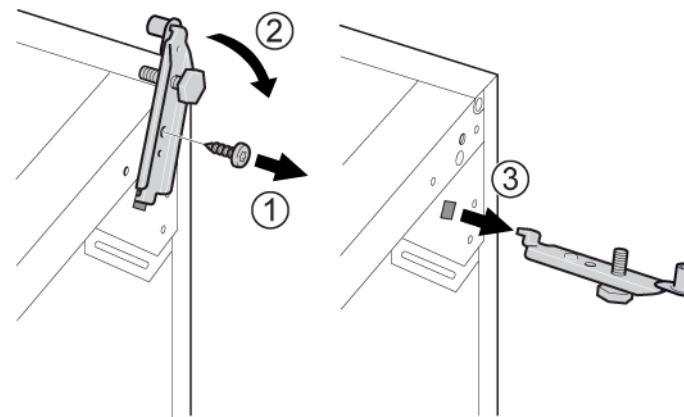

➡ Spodní závěs je vyjmutý.

#### **4.6.2 Montáž spodního závěsu dvířek**

- ▶ Montáž proveďte v opačném sledu.



## 4.7 Výměna odkládací plochy

### Požadavek:

- ✔ Dvířka jsou otevřená.

### 4.7.1 Vyjmutí odkládací plochy

- ▶ Vytáhněte odkládací plochu.

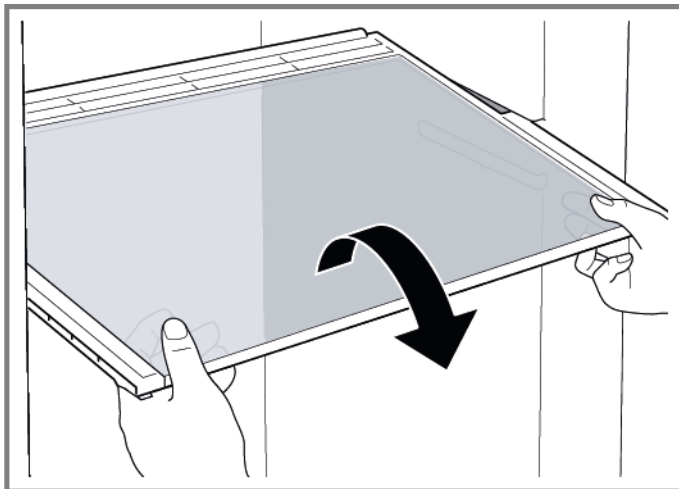

- ➡ Odkládací plocha je vyjmutá.

### 4.7.2 Montáž odkládací plochy

- ▶ Montáž proveďte v opačném sledu.

## 4.8 Výměna zásobníku na zmrazené potraviny

### Požadavek:

- ✔ Dvířka jsou otevřená.

### 4.8.1 Vyjmutí zásobníku na zmrazené potraviny

- ▶ 1. Úplně vytáhněte zásobník na zmrazené potraviny (1).
- ▶ 2. Vyjměte zásobník na zmrazené potraviny (2).

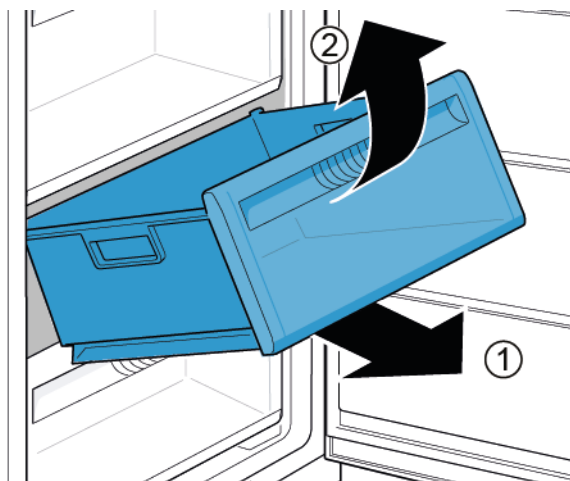

- ➡ Zásobník na zmrazené potraviny je vyjmutý.

### 4.8.2 Montáž zásobníku na zmrazené potraviny

- ▶ Montáž proveďte v opačném sledu.

## 4.9 Výměna výrobku ledu

### Požadavek:

- ✔ Dvířka jsou otevřená.

### 4.9.1 Vyjmutí výrobku ledu

- ▶ 1. Vytáhněte zásobník na zmrazené potraviny spolu s výrobníkem ledu (1).
- ▶ 2. Uvolněte háky (2).
- ▶ 3. Vyjměte výrobek ledu (3).

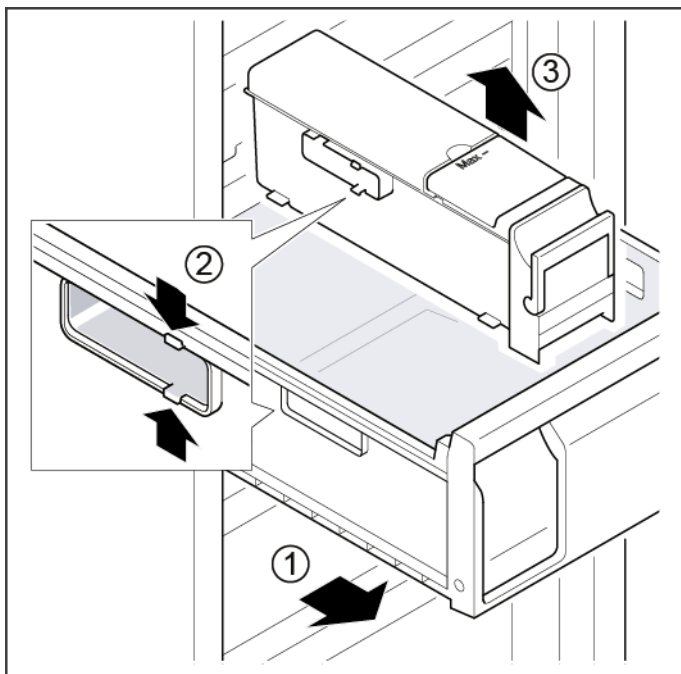

➡ Výrobek ledu je vyjmutý.

### 4.9.2 Montáž výrobku ledu

- ▶ Montáž proveďte v opačném sledu.

## 4.10 Výměna LED horního osvětlení

### Speciální nástroje:

-  Plochý šroubovák
-  Čepel 2,4 mm x 0,4 mm x 60 mm, v sadě [00341820]



	Váš spotřebič je vybaven bezúdržbovým LED osvětlením. Tato osvětlení smí být opravena pouze zákaznickým servisem nebo oprávněným technikem!
---	---

	<b>⚠ NEBEZPEČÍ</b>
<b>Nebezpečí úrazu elektrickým proudem při dotyku dílů pod proudem!</b>	
V případě neodborné opravy hrozí nebezpečí smrtelného úrazu elektrickým proudem	
<ul style="list-style-type: none"> <li>▶ Opravu elektrického zařízení smí provádět jen kvalifikovaný elektrikář.</li> <li>▶ Po opravě nechte provést bezpečnostní zkoušku podle VDE 0701 nebo specifických předpisů dané země.</li> </ul>	

	<b>⚠ NEBEZPEČÍ</b>
<b>Nebezpečí úrazu elektrickým proudem při dotyku dílů pod proudem!</b>	
Usmrcení elektrickým proudem	
<ul style="list-style-type: none"> <li>▶ Odpojte spotřebič od přívodu elektrického proudu alespoň 60 sekund před zahájením opravy.</li> </ul>	

	<b>⚠ POZOR</b>
<b>Ostré hrany!</b>	
Nebezpečí řezných poranění	
<ul style="list-style-type: none"> <li>▶ Používejte ochranné rukavice.</li> </ul>	

### Požadavek:

-  Spotřebič je odpojený od přívodu elektrické energie.
-  Dvířka jsou otevřená.
-  Horní vnitřní kování je vyjmuto.

### 4.10.1 Vyjmutí LED osvětlení

1. Posuňte LED osvětlení k levé straně.



-  Elektrické připojení LED osvětlení je odpojené.

2. Uvolněte háky LED osvětlení.

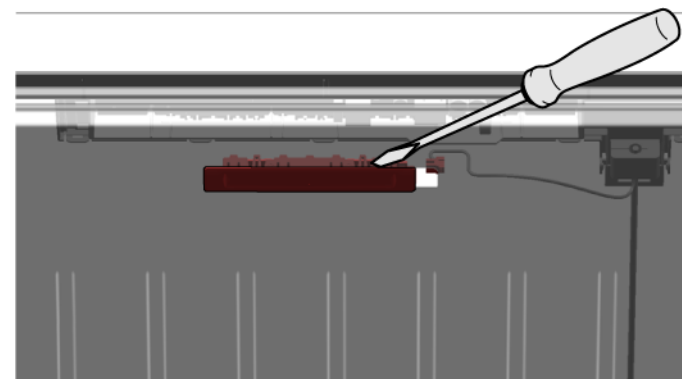

3. Odstraňte LED osvětlení jeho posunutím dopředu.

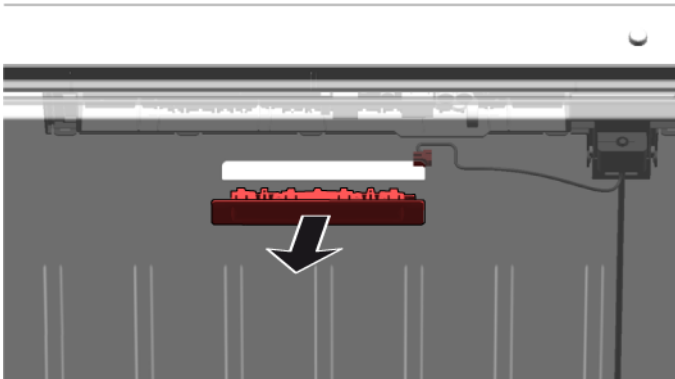

- ➔ LED osvětlení je vyjmuté.

### 4.10.2 Montáž horního LED osvětlení

- ▶ Montáž proveďte v opačném sledu.

# Tip til reparation - Fryser

 <b>Om dette dokument</b> .....	<b>71</b>
1.1 Vigtig information.....	71
1.1.1 Formål.....	71
1.2 Forklaring af symboler .....	71
1.2.1 Fareniveauer .....	71
1.2.2 Faresymboler.....	71
1.2.3 Advarslernes opbygning .....	72
1.2.4 Generelle symboler .....	72
 <b>Sikkerhed</b> .....	<b>73</b>
2.1 Generelle sikkerhedsanvisninger .....	73
2.1.1 Alle husholdningsapparater .....	73
 <b>Værktøjer og hjælpemidler</b> .....	<b>74</b>
 <b>Reparation</b> .....	<b>75</b>
4.1 Udskiftning af dørpakning.....	75
4.1.1 Fjernelse af dørpakning.....	75
4.1.2 Montering af dørpakning.....	75
4.2 Udskiftning af dørhåndtag .....	78
4.2.1 Fjernelse af dørhåndtag .....	78
4.2.2 Montering af dørhåndtag .....	78
4.3 Udskiftning af easy open-håndtag.....	79
4.3.1 Fjernelse af easy open-håndtag .....	79
4.3.2 Montering af easy open-håndtag.....	79
4.4 Udskiftning af øverste dørhængsel .....	80
4.4.1 Fjernelse af dørhængsel.....	80
4.4.2 Montering af dørhængsel.....	82
4.5 Udskiftning af det øverste dørhængsel (dør med display).....	83
4.5.1 Fjernelse af dørhængsel.....	84
4.5.2 Montering af dørhængsel.....	85
4.6 Udskiftning af nederste dørhængsel .....	86
4.6.1 Udskiftning af nederste dørhængsel.....	86
4.6.2 Montering af nederste dørhængsel.....	86
4.7 Udskiftning af hylde .....	87
4.7.1 Fjernelse af hylde.....	87
4.7.2 Montering af hylde .....	87

4.8 Udskiftning af frostvarebeholder.....	88
4.8.1 Fjernelse af frostvarebeholder .....	88
4.8.2 Montering af frostvarebeholder .....	88
4.9 Udskiftning af ismaskine .....	89
4.9.1 Fjernelse af ismaskine .....	89
4.9.2 Montering af ismaskine .....	89
4.10 Udskiftning af LED-lampe foroven .....	90
4.10.1 Fjernelse af LED-lampe .....	90
4.10.2 Montering af LED-lampe foroven .....	91

# **i** Om dette dokument

## 1.1 Vigtig information

### 1.1.1 Formål

Disse reparationsanvisninger hjælper kunden til selv at kunne reparere apparater i henhold til den gældende lovgivning om miljøvenligt design (fra 03/2021).





De indeholder information om, hvordan der udskiftes bestemte reservedele, herunder advarsler og risici.

Kontakt kundeservice i tilfælde af spørgsmål. Vi påtager os kun ansvar for skader, hvis reparationsanvisningerne er fuldt korrekt.

## 1.2 Forklaring af symboler

### 1.2.1 Fareniveauer

Advarselsniveauerne består af et symbol og et signalford. Signalfordene indikerer farens alvor.





Advarselsniveau	Betydning
	Manglende overholdelse af advarselsmeddelelsen vil medføre død eller alvorlige kvæstelser.
	Manglende overholdelse af advarselsmeddelelsen kan medføre død eller alvorlige kvæstelser.
	Manglende overholdelse af advarselsmeddelelsen kan medføre mindre kvæstelser.
	Manglende overholdelse af advarselsmeddelelsen kan medføre materiel beskadigelse.

Tabel 1: Fareniveauer





### 1.2.2 Faresymboler

Faresymboler er symbolske visninger, der giver en indikation af faretypen.

Der anvendes følgende faresymboler i dette dokument:

Faresymbol	Betydning
	Generel advarselsmeddelelse
	Fare for elektrisk spænding
	Eksplussionsfare
	Fare for at skære sig

## i Om dette dokument

Faresymbol	Betydning
	Fare for klemning
	Fare pga. varme overflader
	Fare pga. kraftigt magnetfelt
	Fare pga. ikke-ioniserende stråling

Tabel 2: Faresymboler

### 1.2.3 Advarslernes opbygning

Advarsler i dette dokument har et standardiseret udseende og en standardiseret opbygning.







	<div style="background-color: red; color: white; padding: 2px; text-align: center;"><b>FARE</b></div> <p><b>Farens type og kilde!</b> Mulige følger, hvis faren/advarslen ignoreres.</p> <ul style="list-style-type: none"> <li>▶ Foranstaltninger og forbud for at forhindre faren.</li> </ul>
--	---

De følgende eksempler viser en advarsel, der advarer mod elektrisk stød pga. spændingsførende dele. Foranstaltningen til at undgå faren er nævnt.

	<div style="background-color: red; color: white; padding: 2px; text-align: center;"><b>FARE</b></div> <p><b>Fare for elektrisk stød pga. spændingsførende dele!</b> Død ved elektrisk stød</p> <ul style="list-style-type: none"> <li>▶ Afbryd apparater fra strømforsyningen i mindst 60 sekunder, før reparationer påbegyndes.</li> </ul>
--	---

### 1.2.4 Generelle symboler

Der anvendes følgende generelle symboler i dette dokument:

Generelt symbol	Betydning
	Angivelse af et særligt tip (tekst og/eller grafik)
	Angivelse af et simpelt tip (kun tekst)
	Angivelse af et link til en videotutorial
	Angivelse af nødvendige værktøjer
	Angivelse af krævede forudsætninger
	Angivelse af en betingelse (hvis..., så...)
	Angivelse af et resultat
	Angivelse af en tast eller knap
	Angivelse af et materialenummer
	Angivelse af en vist tekst/et vist vindue (i apparatets display)

Tabel 3: Generelle symboler



## 2.1 Generelle sikkerhedsanvisninger

### 2.1.1 Alle husholdningsapparater

#### **Fare for elektrisk stød pga. spændingsførende dele!**

- Fejl i forbindelse med reparationer, der involverer elektriske komponenter, kan medføre elektrisk stød!
- Afbryd apparatet fra strømnettet i mindst 60 sekunder, før arbejdet påbegyndes.
- Få efter reparationen udført en sikkerhedstest i henhold til VDE 0701 eller landespecifikke forskrifter.

#### **Fare for tilskadekomst pga. skarpe kanter!**

- Brug beskyttelseshandsker.

#### **Fare for klemning i forbindelse med reparation, vedligeholdelse, fejlafhjælpning og service på grund af tunge og bevægelige komponenter**

- Brug sikkerhedssko.
- Sørg for at sikre tunge komponenter mod at falde ned.
- Stik kropsdele ind i bevægelige komponenter.



#### **Fare for apparatets sikkerhed/funktion!**

- Brug kun originale reservedele.

#### **Fare for beskadigelse af elektrostatisk følsomme komponenter (elektrostatiske afladninger)!**

- Berør ikke modulerne, herunder forbindelser og ledningsbaner.

## Værktøjer og hjælpemidler

Betegnelse	Detaljer	Billeder
Beskyttelsesklud [00342013]	60 cm x 50 cm	
Phillips-skruetrækker PH2		
Torx-bit TX20 [00340865]	6,3 mm (1/4")	
Kærnskruetrækker	Blad 2,4 mm x 0,4 mm x 60 mm i sættet [00341820]	

## 4.1 Udskiftning af dørpakning

### Preindstilling:

- ✔ Døren er åben.

### 4.1.1 Fjernelse af dørpakning

1. Frigør dørpakningen fra rillen i højre og venstre hjørne.

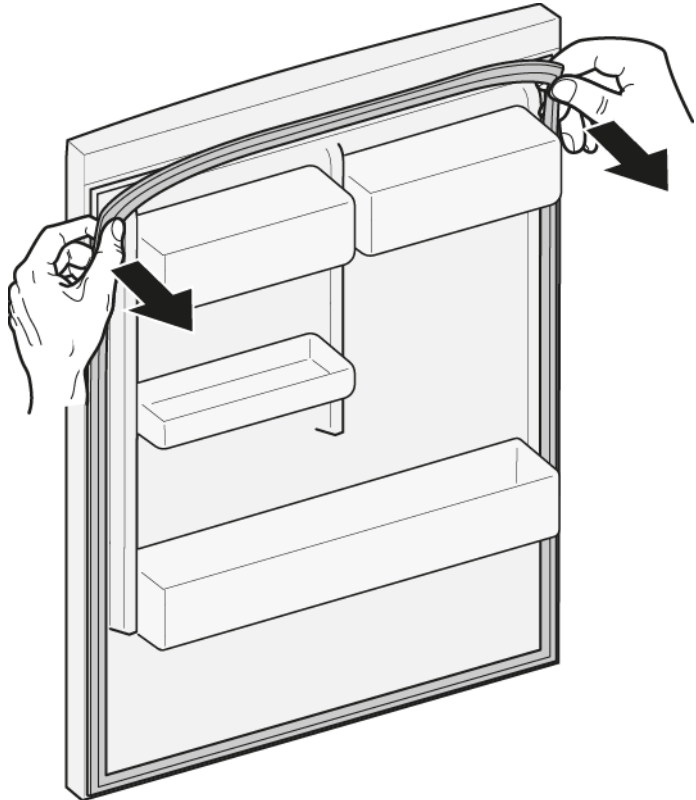

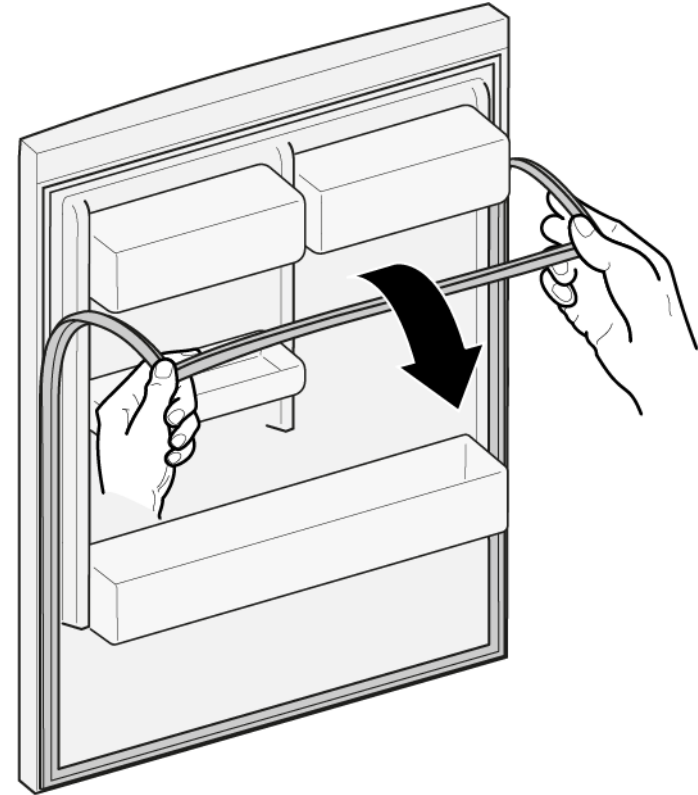

2. Træk dørpakningen ud af rillen.



- ➡ Dørpakningen er fjernet.

### 4.1.2 Montering af dørpakning

	Tykkelsen af den nye dørpakning kan afvige en smule fra tykkelsen af den gamle dørpakning. Dette vil ikke påvirke lukkemåden og den langsigtede funktion.
	Hvis apparatet har justerbare hængsler eller hængselbeslag, kan lukkemåden efterfølgende optimeres.
	Små sidehuller i dørpakningen er funktionelle (nødvendige til lufttilførelse). De er ikke produktionsfejl.

## Reparation

1. Kontrollér rillen til pakningen med hensyn til beskadigelse.

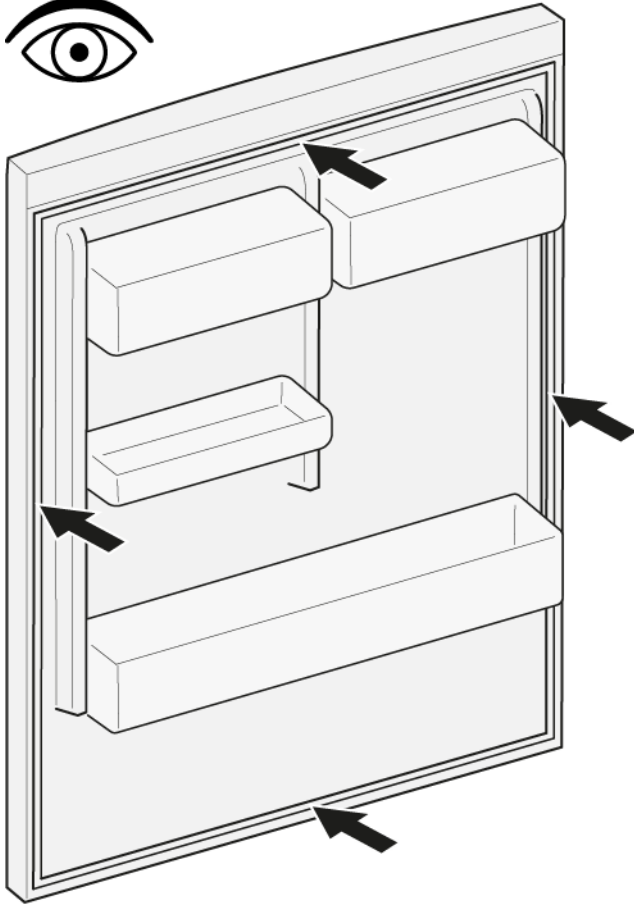

4. Tryk pakningens hjørner i rillen foroven og forneden.

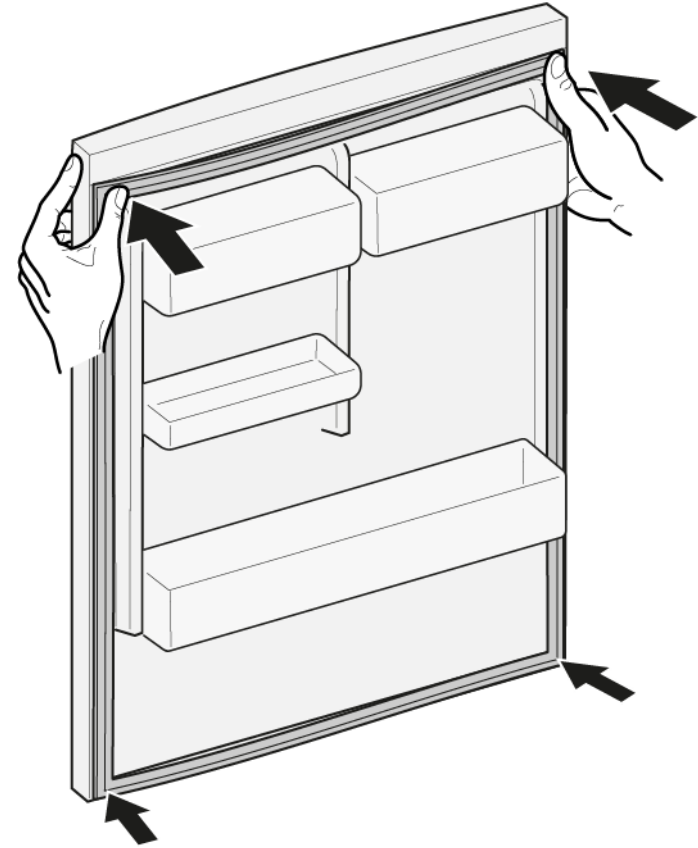

2.  Hvis rillen til pakningen er beskadiget:
  - Kontakt kundeservice.

3.  En smule deformation på dørpakningen er normalt og påvirker ikke dens funktion. Det anbefales til at glatte dørpakningen, før den sættes i apparatet.

Opvarm dørpakningen med en hårtørrer eller varmt vand, og genform den manuelt.

## Reparation



5. Tryk hele pakningen trinvist i rillen.





 Dørpakningen er monteret.

## 4.2 Udskiftning af dørhåndtag

### Nødvendig værktøj:

-  Torx-bit TX20 6,3 mm (1/4") [00340865]
-  Kærviskruetrækker Blad 10 mm x 1,6 mm x 200 mm

### Preindstilling:

-  Apparatet er afbrudt fra strømforsyningen.
-  Døren er åben.

### 4.2.1 Fjernelse af dørhåndtag

- ▶ 1. Fjern de to skruehætter (1).
- ▶ 2. Skru de to skruer ud (2).
- ▶ 3. Fjern dørhåndtaget (3).

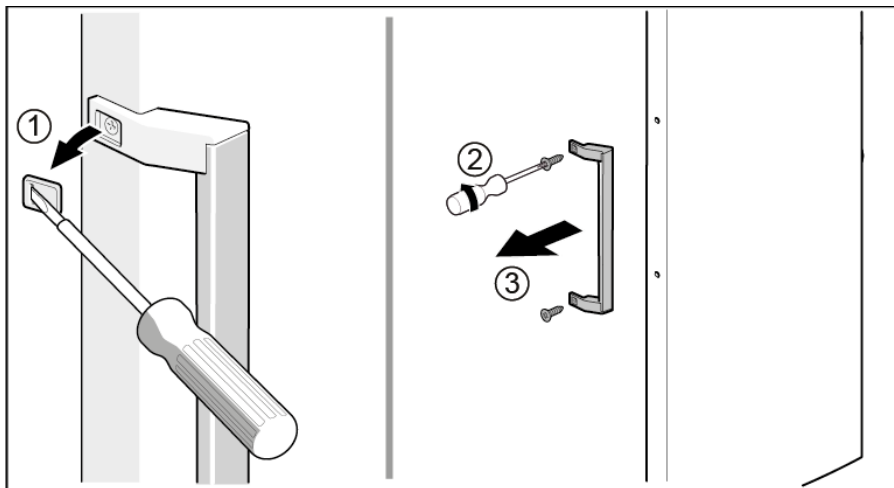

 Dørhåndtaget er fjernet.

### 4.2.2 Montering af dørhåndtag

- ▶ Montér i omvendt rækkefølge.

## 4.3 Udskiftning af easy open-håndtag

### Nødvendig værktøj:

- 🔩 Phillips-skruetrækker PH2

### Preindstilling:

- ✅ Apparatet er afbrudt fra strømforsyningen.
- ✅ Døren er åben.

### 4.3.1 Fjernelse af easy open-håndtag

- ▶ 1. Fjern easy open-håndtagets afdækning (1).
- ▶ 2. Skru de to skruer ud (2).

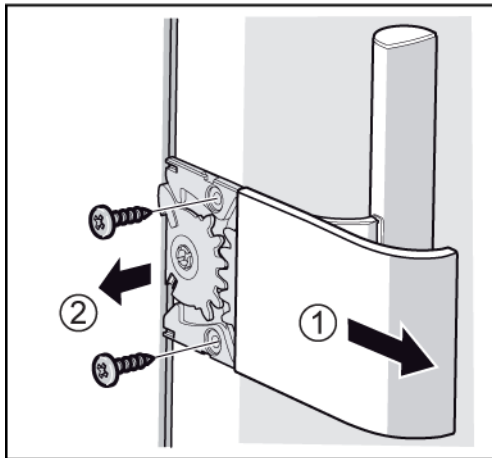

- ➡ Easy open-håndtaget er fjernet.

## 4.3.2 Montering af easy open-håndtag

Easy open-håndtagets mekanisme skal indstilles korrekt før monteringen.

Korrekt placering af stødtap (1), tandbue (2) og (3), fjeder (4) og endestop (5) til montering i venstre side af døren er vist på grafikken.

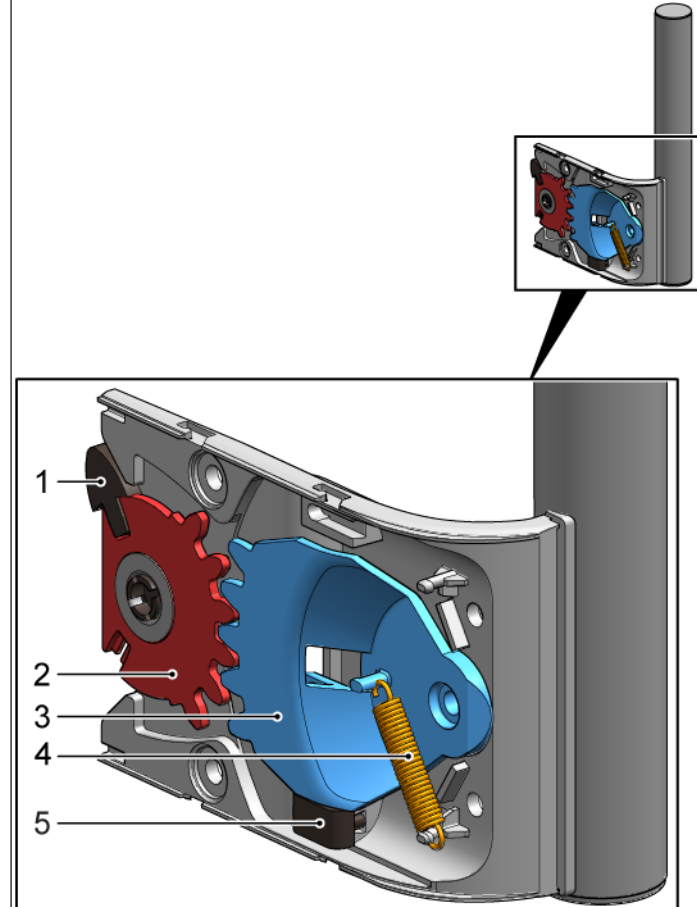

Placeringen af easy open-håndtagets delkomponenter til montering i højre side af døren er beskrevet i dokumentet "Monteringsanvisning".

- ▶ Monter i omvendt rækkefølge.





## 4.4 Udskiftning af øverste dørhængsel

### Nødvendig værktøj:



 Torx-bit TX20

6,3 mm (1/4")

[00340865]

	<p><b>⚠ ADVARSEL</b></p> <p><b>Tunge, store apparater!</b> Ryg- og muskelskader</p> <ul style="list-style-type: none"><li>▶ Arbejde til fjernelse af apparatets dør bør kun udføres af uddannede specialister.</li><li>▶ Der skal være to personer om at flytte apparatet.</li><li>▶ Brug kun egnet værktøj og udstyr.</li></ul>
	<p><b>⚠ PAS PÅ!</b></p> <p><b>Skarpe kanter!</b> Snitlæsioner</p> <ul style="list-style-type: none"><li>▶ Brug beskyttelseshandsker.</li></ul>
	<p><b>⚠ ADVARSEL</b></p> <p><b>Apparater på skrå kan glide!</b> Knoglebrud/klemskader</p> <ul style="list-style-type: none"><li>▶ Sørg for at sikre apparater mod at glide.</li></ul>
	<p><b>⚠ PAS PÅ!</b></p> <p><b>Fare for nedfaldende dele pga. løsnede skruer!</b> Personskade pga. nedfaldende dele.</p> <ul style="list-style-type: none"><li>▶ Sørg for at sikre komponenten mod at falde ned.</li></ul>
	<p><b>BEMÆRK!</b></p> <p><b>Fare for nedfaldende dele pga. løsnede skruer!</b> Beskadigelse af andre apparatdele eller kundens hjem, f.eks. gulvet.</p> <ul style="list-style-type: none"><li>▶ Sørg for at sikre komponenten mod at falde ned.</li></ul>

### Preindstilling:

-  Apparatet er afbrudt fra strømforsyningen.
-  Indvendigt tilbehør i apparatet er fjernet.

## 4.4.1 Fjernelse af dørhængsel



## Reparation

1. Læg apparatet med bagsiden nedad.

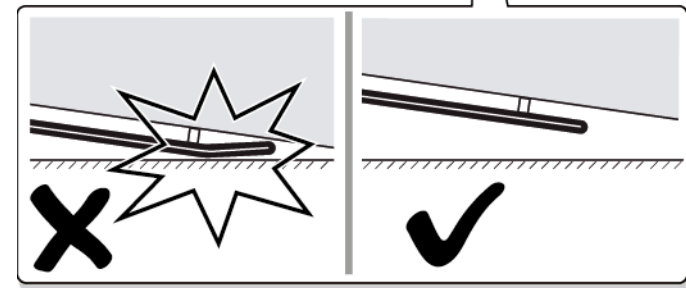
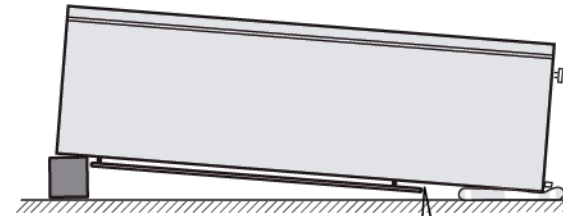
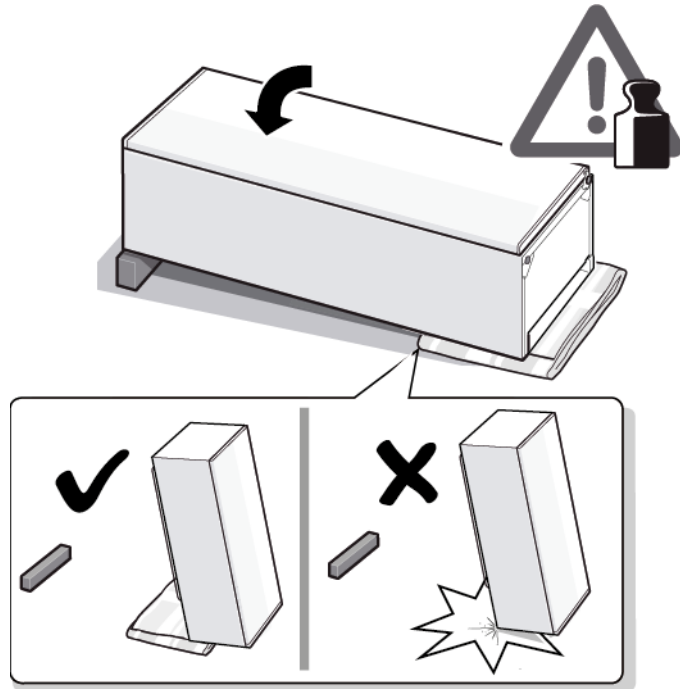

2. 1. Tryk det øverste hængsels afdækning på begge sider (1).  
2. Bevæg det øverste hængsels afdækning ud (2).  
3. Fjern det øverste hængsels afdækning (3).

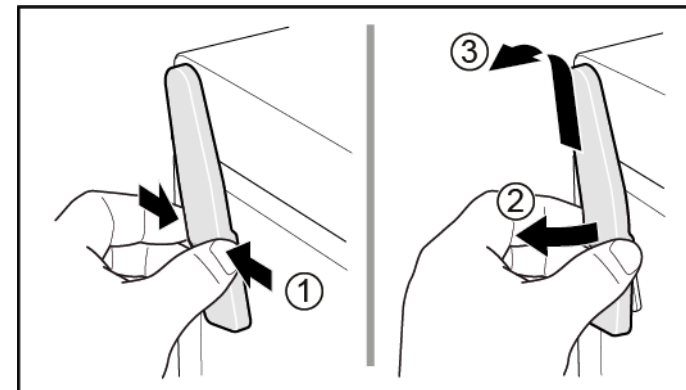

## Reparation

3.
  1. Skru de to skruer ud (1).
  2. Fjern det øverste hængsel (2).

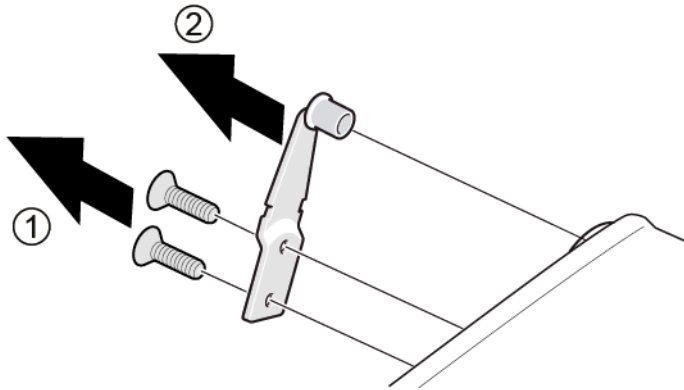

 Det øverste dørhængsel er fjernet.

### 4.4.2 Montering af dørhængsel

- ▶ Montér i omvendt rækkefølge.

## 4.5 Udskiftning af det øverste dørhængsel (dør med display)

Nødvendig værktøj:

 Torx-bit TX20      6,3 mm (1/4")      [00340865]

	<b>⚠ ADVARSEL</b>
	<b>Tunge, store apparater!</b> Ryg- og muskelskader <ul style="list-style-type: none"><li>▶ Arbejde til fjernelse af apparatets dør bør kun udføres af uddannede specialister.</li><li>▶ Der skal være to personer om at flytte apparatet.</li><li>▶ Brug kun egnet værktøj og udstyr.</li></ul>

	<b>⚠ PAS PÅ!</b>
	<b>Skarpe kanter!</b> Snitlæsioner <ul style="list-style-type: none"><li>▶ Brug beskyttelseshandsker.</li></ul>

	<b>⚠ ADVARSEL</b>
	<b>Apparater på skrå kan glide!</b> Knoglebrud/klemskader <ul style="list-style-type: none"><li>▶ Sørg for at sikre apparater mod at glide.</li></ul>

	<b>⚠ PAS PÅ!</b>
	<b>Fare for nedfaldende dele pga. løsnede skruer!</b> Personskade pga. nedfaldende dele. <ul style="list-style-type: none"><li>▶ Sørg for at sikre komponenten mod at falde ned.</li></ul>

	<b>BEMÆRK!</b>
	<b>Fare for nedfaldende dele pga. løsnede skruer!</b> Beskadigelse af andre apparatdele eller kundens hjem, f.eks. gulvet. <ul style="list-style-type: none"><li>▶ Sørg for at sikre komponenten mod at falde ned.</li></ul>

	<b>⚠ FARE</b>
	<b>Fare for elektrisk stød pga. spændingsførende dele!</b> Livsfare pga. elektrisk stød i tilfælde af ukorrekt reparation <ul style="list-style-type: none"><li>▶ Elektriske dele skal repareres af kvalificerede elektrikere.</li><li>▶ Få efter reparationen udført en sikkerhedstest i henhold til VDE 0701 eller landespecifikke forskrifter.</li></ul>

	<b>⚠ FARE</b>
	<b>Fare for elektrisk stød pga. spændingsførende dele!</b> Død ved elektrisk stød <ul style="list-style-type: none"><li>▶ Afbryd apparater fra strømforsyningen i mindst 60 sekunder, før reparationer påbegyndes.</li></ul>

**Preindstilling:**

- Apparatet er afbrudt fra strømforsyningen.
- Indvendigt tilbehør i apparatet er fjernet.

## 4.5.1 Fjernelse af dørhængsel

1. Læg apparatet med bagsiden nedad.

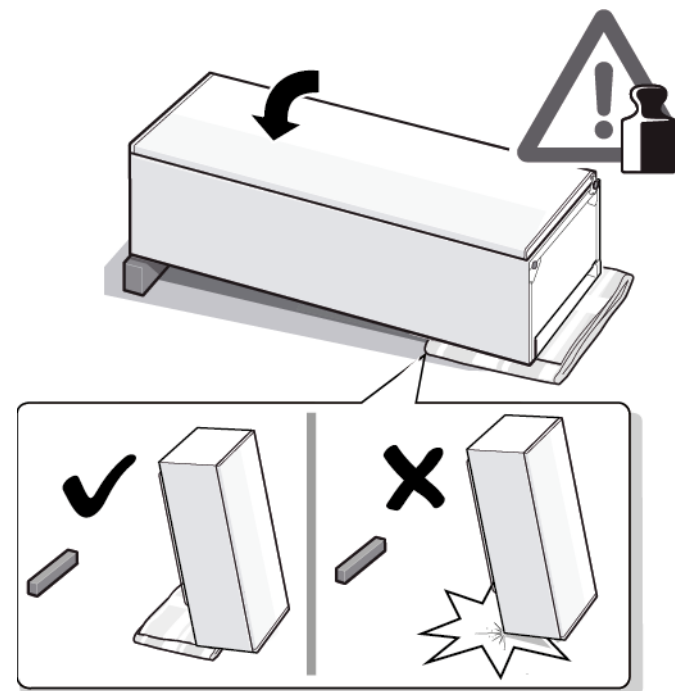

## Reparation

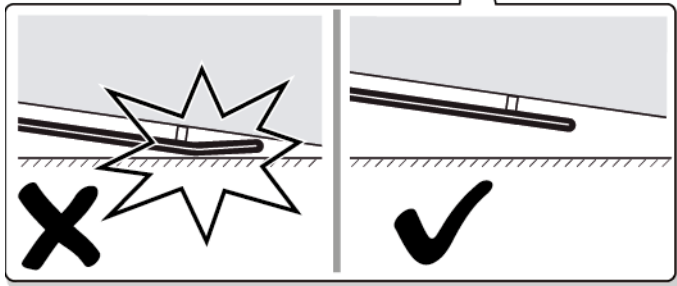
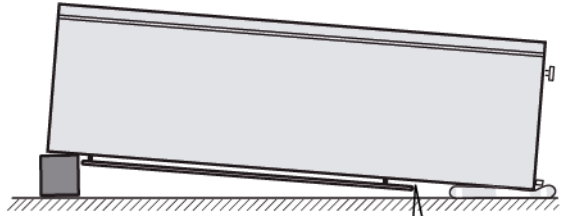

1. Tryk det øverste hængsels afdækning på begge sider (1).
2. Bevæg det øverste hængsels afdækning ud (2).
3. Fjern det øverste hængsels afdækning (3).

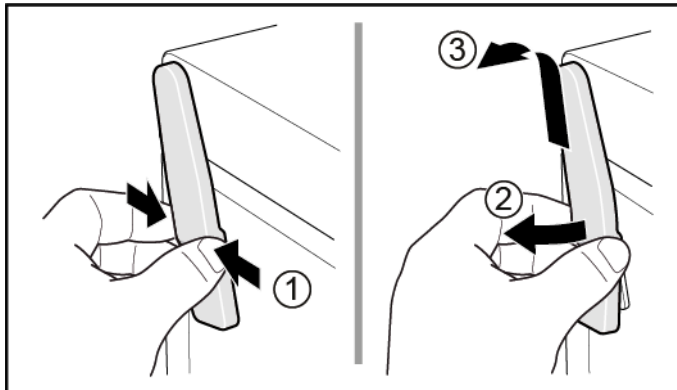

1. Fjern kabelboksens afdækning (1).
2. Fjern kabelbeskyttelsen (2).
3. Afbryd den elektriske tilslutning (3).
4. Skru de to skruer ud (4).
5. Fjern det øverste hængsel (5).

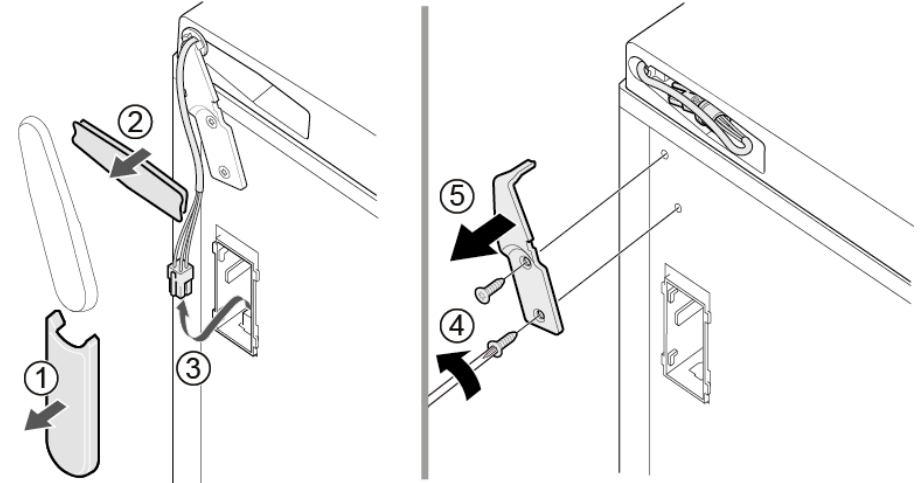

➡ Det øverste dørhængsel er fjernet.

### 4.5.2 Montering af dørhængsel

- ▶ Monter i omvendt rækkefølge.

## 4.6 Udskiftning af nederste dørhængsel

### Nødvendig værktøj:

🌀 Torx-bit TX20

6,3 mm (1/4")

[00340865]

	<b>⚠ ADVARSEL</b>
	<p><b>Tunge, store apparater!</b> Ryg- og muskelskader</p> <ul style="list-style-type: none"> <li>▶ Arbejde til fjernelse af apparatets dør bør kun udføres af uddannede specialister.</li> <li>▶ Der skal være to personer om at flytte apparatet.</li> <li>▶ Brug kun egnet værktøj og udstyr.</li> </ul>

	<b>⚠ PAS PÅ!</b>
	<p><b>Skarpe kanter!</b> Snitlæsioner</p> <ul style="list-style-type: none"> <li>▶ Brug beskyttelseshandsker.</li> </ul>

	<b>⚠ ADVARSEL</b>
	<p><b>Apparater på skrå kan glide!</b> Knoglebrud/klemskader</p> <ul style="list-style-type: none"> <li>▶ Sørg for at sikre apparater mod at glide.</li> </ul>

	<b>⚠ PAS PÅ!</b>
	<p><b>Fare for nedfaldende dele pga. løsnede skruer!</b> Personskade pga. nedfaldende dele.</p> <ul style="list-style-type: none"> <li>▶ Sørg for at sikre komponenten mod at falde ned.</li> </ul>

	<b>BEMÆRK!</b>
	<p><b>Fare for nedfaldende dele pga. løsnede skruer!</b> Beskadigelse af andre apparatdele eller kundens hjem, f.eks. gulvet.</p> <ul style="list-style-type: none"> <li>▶ Sørg for at sikre komponenten mod at falde ned.</li> </ul>

### Preindstilling:

- ✅ Apparatet er afbrudt fra strømforsyningen.
- ✅ Indvendigt tilbehør i apparatet er fjernet.
- ✅ Apparatet er lagt med bagsiden nedad.
- ✅ [Det øverste hængsel er fjernet. → 83](#)

### 4.6.1 Udskiftning af nederste dørhængsel

1. Fjern døren.

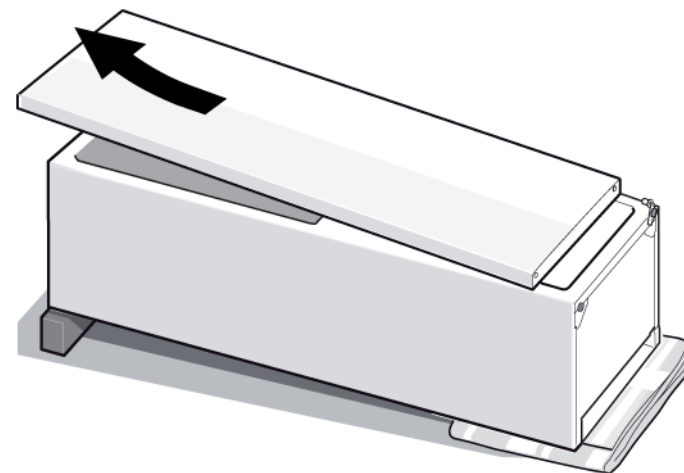

2.
  1. Skru skruen ud (1).
  2. Drej det nederste hængsel ud (2).
  3. Fjern det nederste hængsel (3).

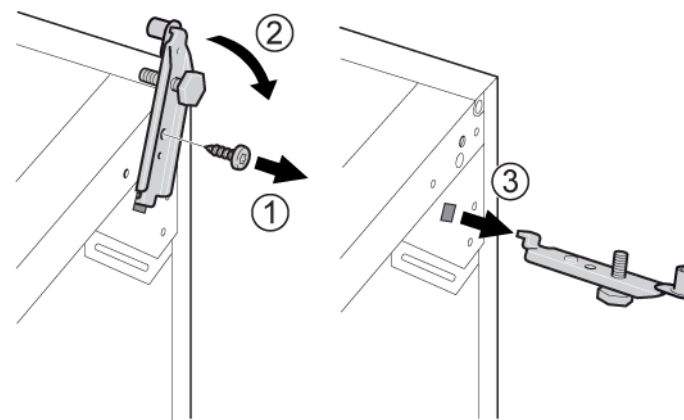

➡ Det nederste hængsel er fjernet.

### 4.6.2 Montering af nederste dørhængsel

- ▶ Monter i omvendt rækkefølge.

## 4.7 Udskiftning af hylde

Preindstilling:

- ✔ Døren er åben.

### 4.7.1 Fjernelse af hylde

- ▶ Træk hylde ud.

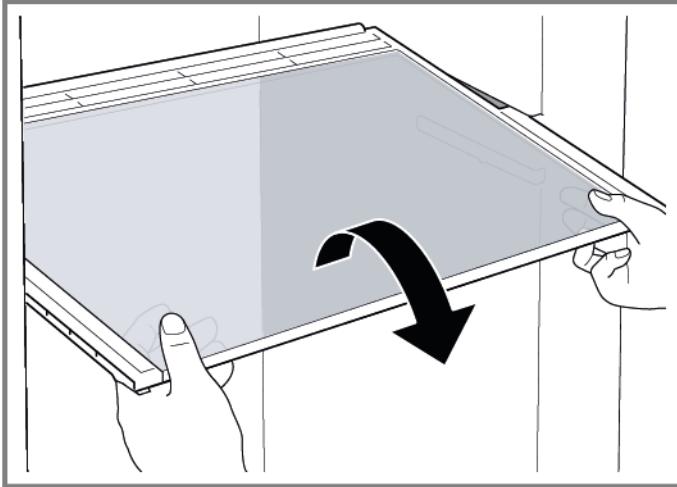

- ➡ Hylde er fjernet.

### 4.7.2 Montering af hylde

- ▶ Montér i omvendt rækkefølge.

## 4.8 Udskiftning af frostvarebeholder

### Preindstilling:

- ✓ Døren er åben.

### 4.8.1 Fjernelse af frostvarebeholder

- ▶ 1. Træk frostvarebeholderen hele vejen ud (1).
- ▶ 2. Fjern frostvarebeholderen (2).

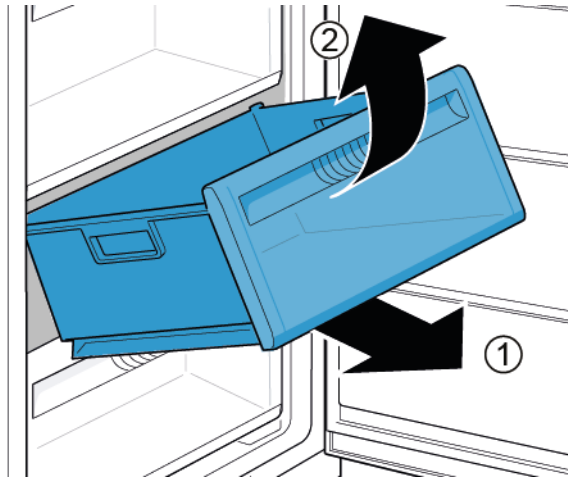

- ➡ Frostvarebeholderen er fjernet.

### 4.8.2 Montering af frostvarebeholder

- ▶ Montér i omvendt rækkefølge.



## 4.9 Udskiftning af ismaskine

### Preindstilling:

- ✔ Døren er åben.

### 4.9.1 Fjernelse af ismaskine

- ▶ 1. Træk frysevarebeholderhylden med ismaskinen ud (1).
- ▶ 2. Frigør krogene (2).
- ▶ 3. Fjern ismaskinen (3).

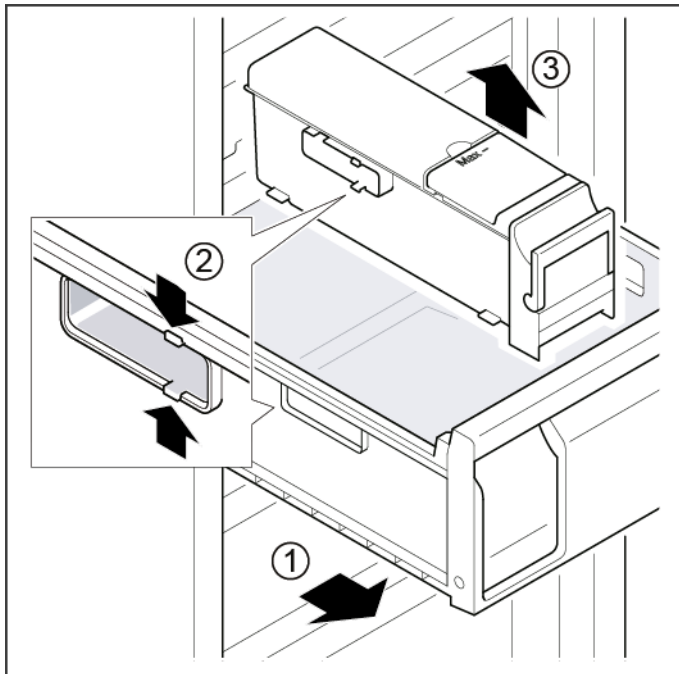

➡ Ismaskinen er fjernet.

### 4.9.2 Montering af ismaskine

- ▶ Montér i omvendt rækkefølge.

## 4.10 Udskiftning af LED-lampe foroven

### Nødvendig værktøj:

- 🔧 Kærviskruetrækker Blad 2,4 mm x 0,4 mm x 60 mm i sættet [00341820]

**i** Dit apparat er udstyret med en vedligeholdelsesfri LED-lampe. Denne lampe må kun repareres af kundeservice eller autoriserede teknikere!

**⚠️ FARE**  
**Fare for elektrisk stød pga. spændingsførende dele!**  
Livsfare pga. elektrisk stød i tilfælde af ukorrekt reparation

- ▶ Elektriske dele skal repareres af kvalificerede elektrikere.
- ▶ Få efter reparationen udført en sikkerhedstest i henhold til VDE 0701 eller landespecifikke forskrifter.

**⚠️ FARE**  
**Fare for elektrisk stød pga. spændingsførende dele!**  
Død ved elektrisk stød

- ▶ Afbryd apparater fra strømforsyningen i mindst 60 sekunder, før reparationer påbegyndes.

**⚠️ PAS PÅ!**  
**Skarpe kanter!**  
Snitlæsioner

- ▶ Brug beskyttelseshandsker.

### Preindstilling:

- ✔️ Apparatet er afbrudt fra strømforsyningen.
- ✔️ Døren er åben.
- ✔️ Indvendigt tilbehør foroven er fjernet.

## 4.10.1 Fjernelse af LED-lampe

1. Bevæg LED-lampen mod venstre.

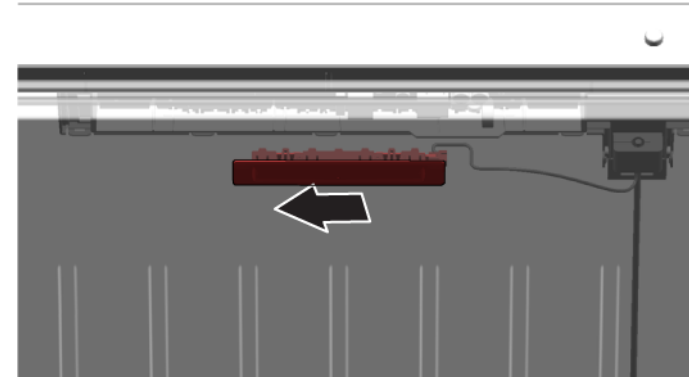

- ➡️ LED-lampens elektriske tilslutning er afbrudt.

2. Frigør LED-lampens kroge.



## Reparation

3. Fjern LED-lampen ved at bevæge den fremad.

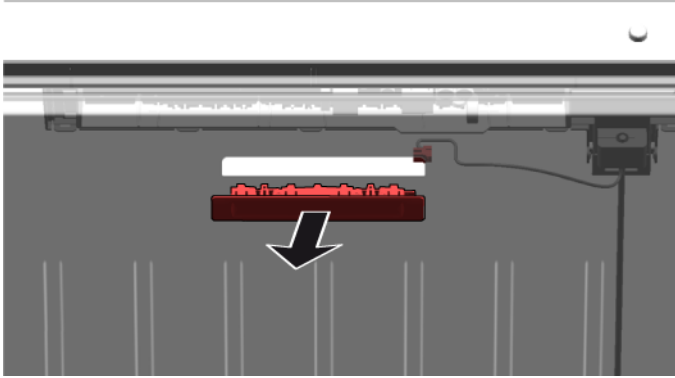

-  LED-lampen er fjernet.

### 4.10.2 Montering af LED-lampe foroven

- ▶ Montér i omvendt rækkefølge.

# Reparatie informatie - Vriezer

 <b>Over dit document</b> .....	<b>93</b>
1.1 Belangrijke informatie .....	93
1.1.1 Doel .....	93
1.2 Verklaring van symbolen.....	93
1.2.1 Gevarenniveaus.....	93
1.2.2 Gevarensymbolen.....	93
1.2.3 Structuur van de waarschuwingen.....	94
1.2.4 Algemene symbolen.....	94
 <b>Veiligheid</b> .....	<b>95</b>
2.1 Algemene veiligheidsinstructies.....	95
2.1.1 Alle huishoudelijke apparaten .....	95
 <b>Gereedschappen en hulpmiddelen</b> .....	<b>96</b>
 <b>Reparatie</b> .....	<b>97</b>
4.1 Deurafdichting vervangen .....	97
4.1.1 Deurafdichting verwijderen .....	97
4.1.2 Deurafdichting monteren .....	97
4.2 Deurgreep vervangen .....	100
4.2.1 Deurgreep verwijderen .....	100
4.2.2 Deurgreep monteren .....	100
4.3 Easy opening handgreep vervangen.....	101
4.3.1 Easy opening handgreep verwijderen.....	101
4.3.2 Easy opening handgreep monteren.....	101
4.4 Bovenste deurscharnier vervangen.....	102
4.4.1 Deurscharnier verwijderen .....	102
4.4.2 Deurscharnier monteren .....	104
4.5 Bovenste deurscharnier vervangen (deur met display).....	105
4.5.1 Deurscharnier verwijderen .....	106
4.5.2 Deurscharnier monteren .....	107
4.6 Onderste deurscharnier vervangen.....	108
4.6.1 Onderste deurscharnier vervangen .....	108
4.6.2 Onderste deurscharnier monteren.....	109
4.7 Plateau vervangen.....	110
4.7.1 Plateau verwijderen.....	110
4.7.2 Plateau monteren.....	110

4.8 Vrieslade vervangen .....	111
4.8.1 Vrieslade verwijderen .....	111
4.8.2 Vrieslade installeren .....	111
4.9 IJsbereider vervangen.....	112
4.9.1 IJsbereider verwijderen .....	112
4.9.2 IJsbereider installeren.....	112
4.10 LED-bovenlicht vervangen.....	113
4.10.1 LED-verlichting verwijderen.....	113
4.10.2 LED-bovenlicht installeren.....	114

# **i** Over dit document

## 1.1 Belangrijke informatie

### 1.1.1 Doel

Met deze reparatieaanwijzingen wordt de klant geholpen zelf apparaten te repareren conform de toepasselijke verordening inzake ecologisch ontwerp (met ingang van 03/2021).





Ze bevatten informatie over hoe gedefinieerde reserveonderdelen kunnen worden vervangen met inbegrip van waarschuwingen en gevaren.

Neem bij vragen contact op met onze klantenservice. We stellen ons alleen aansprakelijk voor schade als de reparatieaanwijzingen correct zijn opgevolgd.

## 1.2 Verklaring van symbolen

### 1.2.1 Gevarenniveaus

De waarschuwningsniveaus worden aangegeven met een symbool en een signaalwoord. Het signaalwoord geeft de ernst van het gevaar aan.





Waarschuwningsniveau	Betekenis
	Als de waarschuwing niet in acht wordt genomen, leidt dat tot ernstig of dodelijk letsel.
	Als de waarschuwing niet in acht wordt genomen, kan dat tot ernstig of dodelijk letsel leiden.
	Als de waarschuwing niet in acht wordt genomen, kan dat tot licht letsel leiden.
	Als de waarschuwing niet in acht wordt genomen, kan dat tot materiële schade leiden.

Tabel 1: Gevarenniveaus

### 1.2.2 Gevarensymbolen

Gevarensymbolen zijn symbolische afbeeldingen die een indicatie geven van het soort gevaar.

De volgende gevarensymbolen worden in dit document gebruikt:

Gevarensymbool	Betekenis
	Algemene waarschuwing
	Gevaar voor elektrische spanning
	Ontploffingsgevaar
	Snijgevaar

## **i** Over dit document

Gevarensymbool	Betekenis
	Beknellingsgevaar
	Gevaar voor hete oppervlakken
	Gevaar voor sterke magnetische velden
	Gevaar voor niet-ioniserende straling

Tabel 2: Gevarensymbolen

### 1.2.3 Structuur van de waarschuwingen

Waarschuwingen in dit document hebben een gestandaardiseerd uiterlijk en een gestandaardiseerde structuur.







	<div style="background-color: red; color: white; padding: 2px; text-align: center;"><b>⚠ GEVAAR</b></div> <p><b>Soort gevaar en bron van het gevaar!</b> Mogelijke gevolgen van het negeren van het gevaar / de waarschuwing.</p> <ul style="list-style-type: none"> <li>▶ Maatregelen en verboden om het gevaar te voorkomen.</li> </ul>
--	---

In het volgende voorbeeld is een waarschuwing te zien waarmee voor een elektrische schok aan stroomvoerende onderdelen wordt gewaarschuwd. De maatregel om het gevaar te vermijden wordt vermeld.

	<div style="background-color: red; color: white; padding: 2px; text-align: center;"><b>⚠ GEVAAR</b></div> <p><b>Gevaar voor een elektrische schok aan stroomvoerende onderdelen!</b> Dood door elektrocutie</p> <ul style="list-style-type: none"> <li>▶ Haal apparaten minstens 60 seconden voor u met reparaties begint van de stroomvoorziening af.</li> </ul>
--	---

### 1.2.4 Algemene symbolen

De volgende algemene symbolen worden in dit document gebruikt:

Alg. symbool	Betekenis
	Identificatie van een speciale tip (tekst en/of afbeelding)
	Identificatie van een eenvoudige tip (tekst)
	Identificatie van een link naar een video-instructie
	Identificatie van vereiste gereedschappen
	Identificatie van vereiste voorwaarden
	Identificatie van een voorwaarde (als ..., dan ...)
	Identificatie van een resultaat
[Start]	Identificatie van een toets of knop
[00123456]	Identificatie van een materiaalnummer
Status	Identificatie van weergegeven tekst / venster (in het display van het apparaat)

Tabel 3: Algemene symbolen

## 2.1 Algemene veiligheidsinstructies

### 2.1.1 Alle huishoudelijke apparaten

#### **Gevaar voor een elektrische schok aan stroomvoerende onderdelen!**

- Fouten bij reparaties aan elektrische componenten kunnen tot een elektrische schok leiden!
- Koppel het apparaat minstens 60 seconden los van het stroomnet voordat u met de werkzaamheden begint.
- Laat na de reparatie een veiligheidstest conform VDE 0701 of de landspecifieke regelgeving uitvoeren.

#### **Gevaar voor letsel aan scherpe randen!**

- Draag veiligheidshandschoenen.

#### **Beknellingsgevaar tijdens reparatie, onderhoud, probleemoplossing en service vanwege zware en bewegende componenten**

- Draag veiligheidsschoenen.
- Beveilig zware componenten tegen vallen.
- Steek geen lichaamsdelen in bewegende componenten.



#### **Gevaar voor de veiligheid / werking van het apparaat!**

- Gebruik uitsluitend originele reserveonderdelen.

#### **Gevaar voor schade aan elektrostatisch gevoelige componenten (ESD's)!**

- Raak de modules met inbegrip van de aansluitingen en geleiderbanen niet aan.

## Gereedschappen en hulpmiddelen

Benaming	Details	Afbeeldingen
Beschermdoek [00342013]	60 cm x 50 cm	
Phillips schroeven- draaier PH2		
Torxbit TX20 [00340865]	6,3 mm (1/4")	
Sleufschroeven- draaier	Kop 2,4 mm x 0,4 mm x 60 mm, in de set [00341820]	



## 4.1 Deurafdichting vervangen

Voorwaarde:

- ✔ Deur is open.

### 4.1.1 Deurafdichting verwijderen

1. Haal deurafdichting los uit de sleuf in de rechter- en linkerhoek.

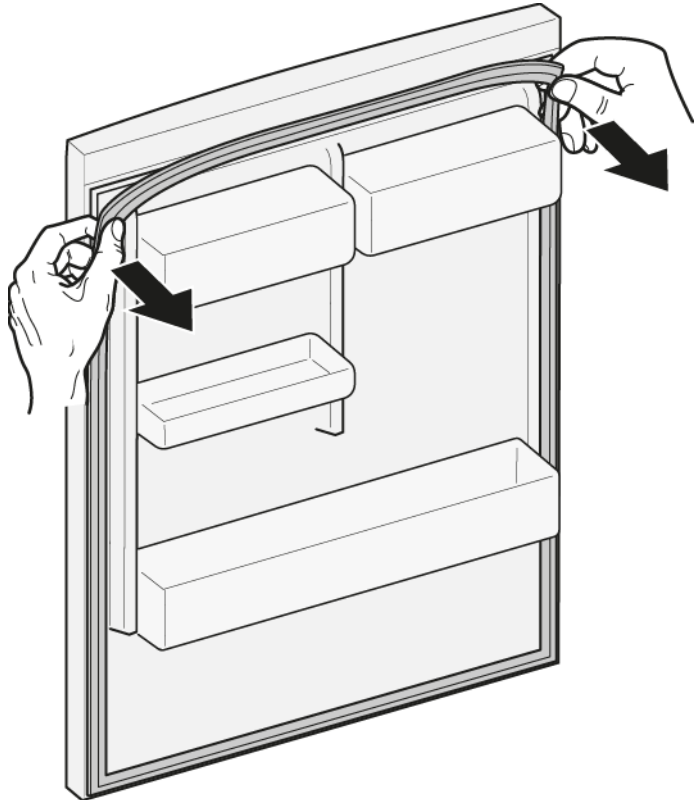

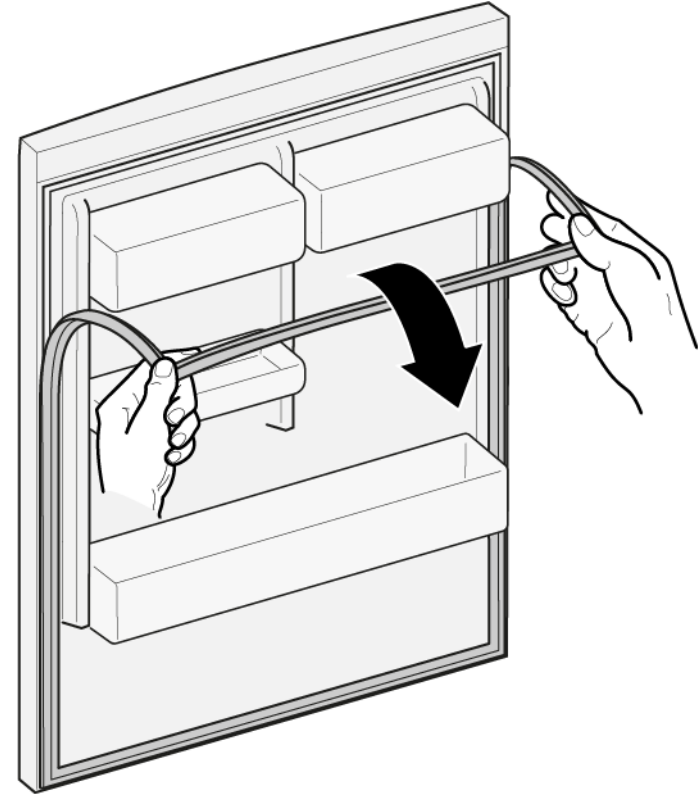

2. Trek deurafdichting uit gleuf.



- ➡ Deurafdichting wordt verwijderd.

### 4.1.2 Deurafdichting monteren

	De dikte van de nieuwe deurafdichting kan licht afwijken van de dikte van de oude deurafdichting. Dit doet geen afbreuk aan de sluiteigenschappen en de werking op de lange termijn.
	Als uw apparaat verstelbare scharnieren of scharnierbevestigingen heeft, kunt u de sluiteigenschappen later optimaliseren.
	De zijgaatjes in de deurafdichting zijn functioneel (vereist voor ventilatie). Dit zijn geen productiefouten.

## Reparatie

1. Controleer de sleuf voor de afdichting op schade.

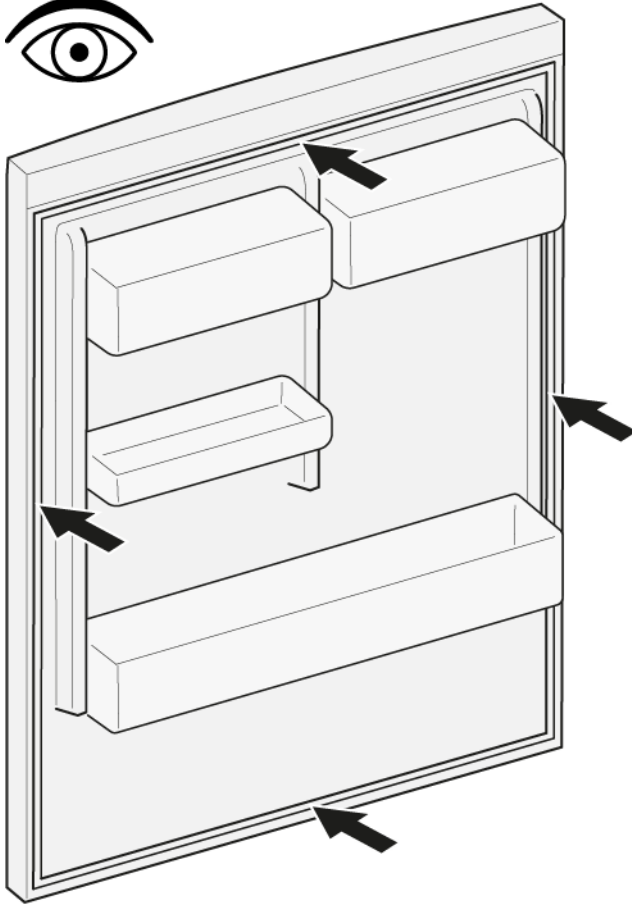

4. Duw de hoeken van de afdichting bovenaan en onderaan in de sleuf.

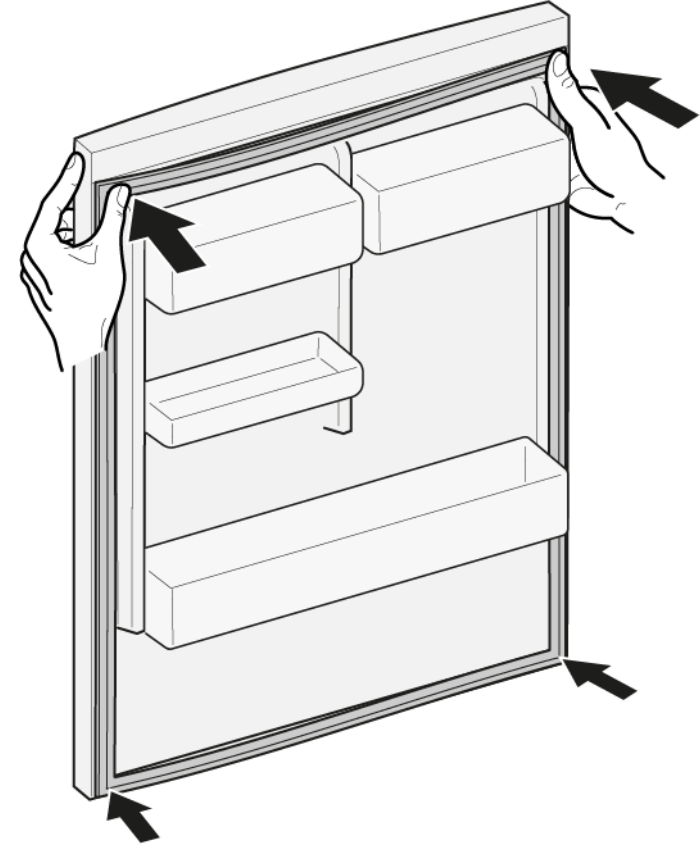

2.  Als de sleuf voor de afdichting is beschadigd:
  - Neem contact op met de klantenservice.

3.  Een lichte vervorming van de deurafdichting is normaal en doet geen afbreuk aan de werking. Geadviseerd wordt de deurafdichting recht te trekken voordat u deze in het apparaat steekt.

Verwarm de deurafdichting met een haardroger of met warm water en breng het handmatig terug in zijn vorm.

## Reparatie



5. Druk de hele afdichting stap voor stap in de sleuf.





-  De deurafdichting wordt gemonteerd.

## 4.2 Deurgreep vervangen

### Speciale hulpmiddelen:

-  Torxbit TX20 6,3 mm (1/4") [00340865]
-  Sleufschroevendraaier Kop 10 mm x 1,6 mm x 200 mm

### Voorwaarde:

-  Apparaat is losgekoppeld is van de stroomvoorziening.
-  Deur is open.

### 4.2.1 Deurgreep verwijderen

- ▶ 1. Verwijder twee schroefkappen (1).
- ▶ 2. Draai de twee schroeven los (2).
- ▶ 3. Verwijder de deurgreep (3).

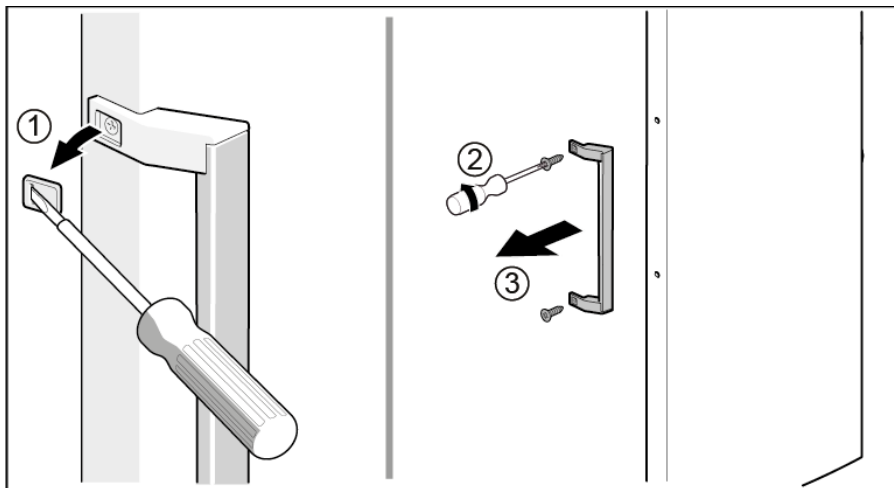

-  Deurgreep wordt verwijderd.

### 4.2.2 Deurgreep monteren

- ▶ Monteer in omgekeerde volgorde.

## 4.3 Easy opening handgreep vervangen

### Speciale hulpmiddelen:

- Phillips schroevendraaier PH2

### Voorwaarde:

- Apparaat is losgekoppeld is van de stroomvoorziening.
- Deur is open.

### 4.3.1 Easy opening handgreep verwijderen

1. Verwijder de kap van de easy opening handgreep (1).
2. Draai de twee schroeven los (2).

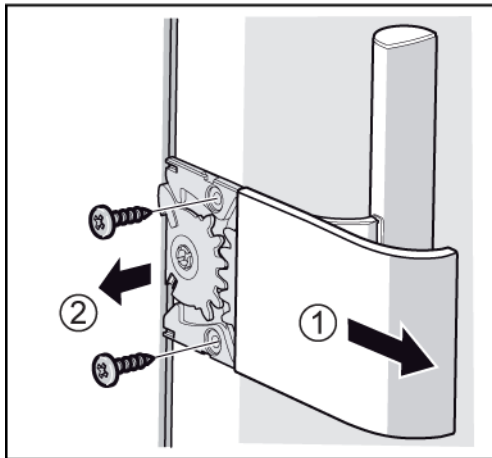

- Easy opening handgreep wordt verwijderd.

## 4.3.2 Easy opening handgreep monteren

Het mechanisme van de easy opening handgreep moet vóór de montage goed worden ingesteld.

De correcte plaatsing van duwstang (1), tandsegmenten (2) en (3), veer (4) en eindaanslag (5) voor de linkzijdige montage van de deur wordt in de tekening aangegeven.

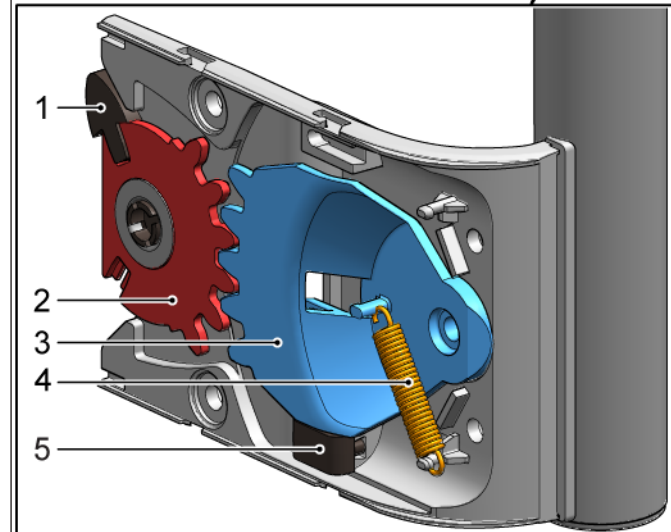
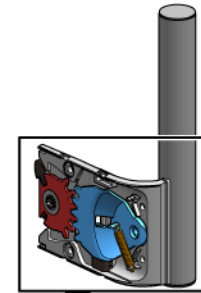

De plaatsing van de subcomponenten van de easy opening handgreep voor rechtszijdige montage van de deur wordt beschreven in het document "Montage-instructie".

- Monteer in omgekeerde volgorde.

## 4.4 Bovenste deurscharnier vervangen

Speciale hulpmiddelen:

 Torxbit TX20                      6,3 mm (1/4")                      [00340865]

	<b>⚠ WAARSCHUWING</b> <b>Zware, omvangrijke apparaten!</b> Rug- en spierletsel <ul style="list-style-type: none"><li>▶ De werkzaamheid van het verwijderen van de apparaatdeur mag alleen worden uitgevoerd door speciaal opgeleid personeel.</li><li>▶ Om het apparaat te verplaatsen zijn twee mensen nodig.</li><li>▶ Gebruik alleen geschikte gereedschappen en apparatuur.</li></ul>
	<b>⚠ VOORZICHTIG</b> <b>Scherpe randen!</b> Snijletsel <ul style="list-style-type: none"><li>▶ Draag veiligheidshandschoenen.</li></ul>
	<b>⚠ WAARSCHUWING</b> <b>Weggliden van schuin staande apparaten!</b> Botbreuken / beknellingsletsel <ul style="list-style-type: none"><li>▶ Beveilig apparaten tegen wegglijden.</li></ul>
	<b>⚠ VOORZICHTIG</b> <b>Gevaar voor vallende onderdelen als gevolg van losgeraakte schroeven!</b> Letsel als gevolg van vallende onderdelen. <ul style="list-style-type: none"><li>▶ Beveilig component tegen vallen.</li></ul>
	<b>LET OP!</b> <b>Gevaar voor vallende onderdelen als gevolg van losgeraakte schroeven!</b> Schade aan andere onderdelen van het apparaat of bij de klant thuis bijvoorbeeld aan de vloer. <ul style="list-style-type: none"><li>▶ Beveilig component tegen vallen.</li></ul>

Voorwaarde:

- ✓ Apparaat is losgekoppeld is van de stroomvoorziening.
- ✓ De inwendige hulpstukken van het apparaat worden verwijderd.

## 4.4.1 Deurscharnier verwijderen

## Reparatie

1. Zet het apparaat op zijn achterkant.

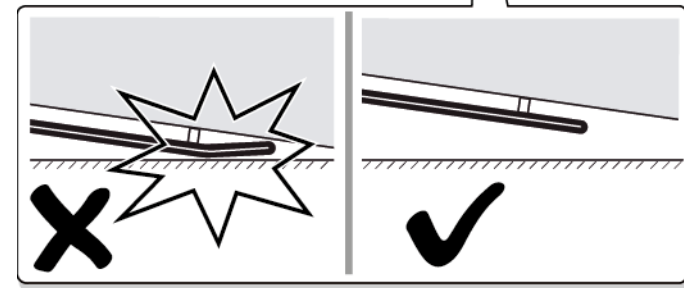
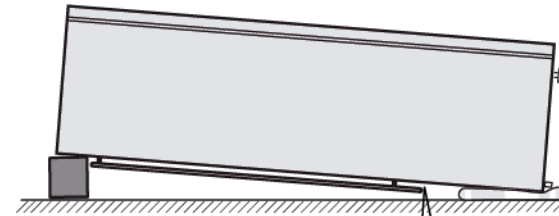
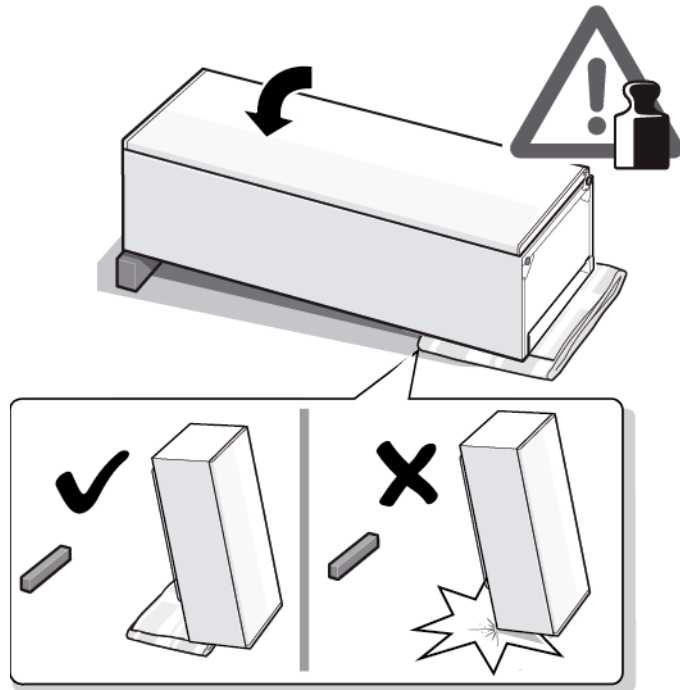

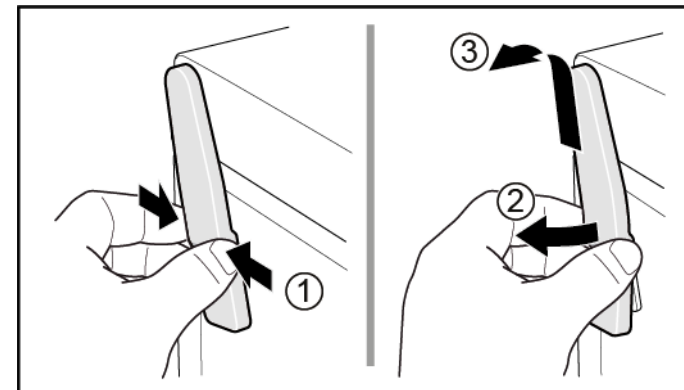

2. 1. Druk aan beide kanten op de bovenste scharnierafdekking (1).  
2. Haal de bovenste scharnierafdekking eruit (2).  
3. Verwijder de bovenste scharnierafdekking (3).

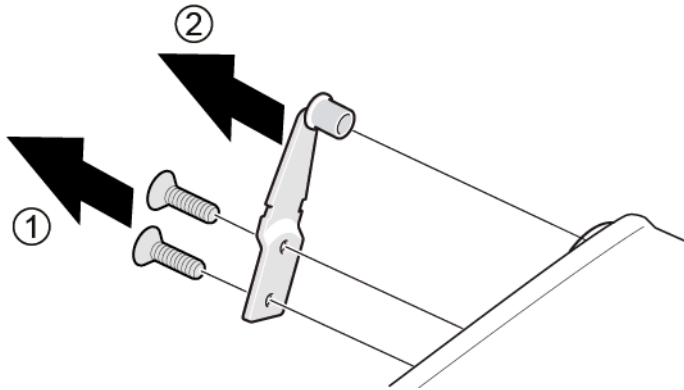

## Reparatie

3.
  1. Draai de twee schroeven los (1).
  2. Verwijder het bovenste scharnier (2).



 Het bovenste deurscharnier wordt verwijderd.

### 4.4.2 Deurscharnier monteren

- ▶ Monteer in omgekeerde volgorde.



## 4.5 Bovenste deurscharnier vervangen (deur met display)

Speciale hulpmiddelen:

 Torxbit TX20                      6,3 mm (1/4")                      [00340865]

	<b>⚠ WAARSCHUWING</b>
	<b>Zware, omvangrijke apparaten!</b> Rug- en spierletsel <ul style="list-style-type: none"><li>▶ De werkzaamheid van het verwijderen van de apparaatdeur mag alleen worden uitgevoerd door speciaal opgeleid personeel.</li><li>▶ Om het apparaat te verplaatsen zijn twee mensen nodig.</li><li>▶ Gebruik alleen geschikte gereedschappen en apparatuur.</li></ul>

	<b>⚠ VOORZICHTIG</b>
	<b>Scherpe randen!</b> Snijletsel <ul style="list-style-type: none"><li>▶ Draag veiligheidshandschoenen.</li></ul>

	<b>⚠ WAARSCHUWING</b>
	<b>Weggliden van schuin staande apparaten!</b> Botbreuken / beknellingsletsel <ul style="list-style-type: none"><li>▶ Beveilig apparaten tegen wegglijden.</li></ul>



	<b>⚠ VOORZICHTIG</b>
	<b>Gevaar voor vallende onderdelen als gevolg van losgeraakte schroeven!</b> Letsel als gevolg van vallende onderdelen. <ul style="list-style-type: none"><li>▶ Beveilig component tegen vallen.</li></ul>

	<b>LET OP!</b>
	<b>Gevaar voor vallende onderdelen als gevolg van losgeraakte schroeven!</b> Schade aan andere onderdelen van het apparaat of bij de klant thuis bijvoorbeeld aan de vloer. <ul style="list-style-type: none"><li>▶ Beveilig component tegen vallen.</li></ul>

	<b>⚠ GEVAAR</b>
	<b>Gevaar voor een elektrische schok aan stroomvoerende onderdelen!</b> Levensgevaar door elektrische schokken in geval van een ondeskundige reparatie <ul style="list-style-type: none"><li>▶ Elektrische onderdelen moeten door gekwalificeerde elektriciens worden gerepareerd.</li><li>▶ Laat na de reparatie een veiligheidstest conform VDE 0701 of de landspecifieke regelgeving uitvoeren.</li></ul>

	<b>⚠ GEVAAR</b>
	<b>Gevaar voor een elektrische schok aan stroomvoerende onderdelen!</b> Dood door elektrocutie <ul style="list-style-type: none"><li>▶ Haal apparaten minstens 60 seconden voor u met reparaties begint van de stroomvoorziening af.</li></ul>

**Voorwaarde:**

-  Apparaat is losgekoppeld is van de stroomvoorziening.
-  Het interieur van het apparaat is verwijderd.

## 4.5.1 Deurscharnier verwijderen

1. Leg het apparaat op zijn achterkant.

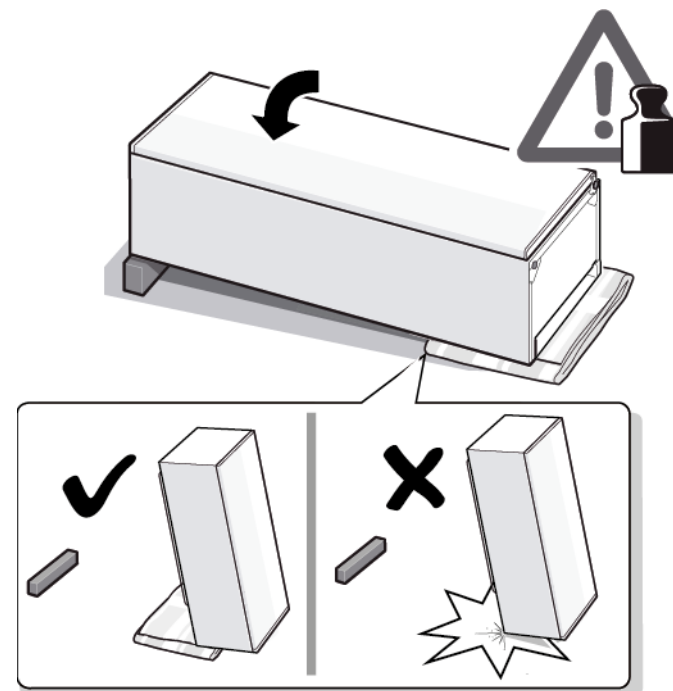

## Reparatie

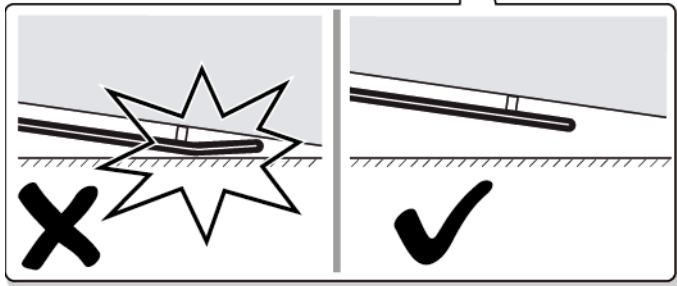
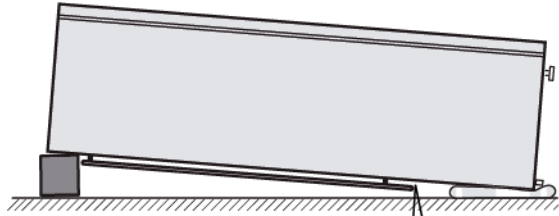

1. Druk aan beide kanten op de bovenste scharnierafdekking (1).
2. Haal de bovenste scharnierafdekking eruit (2).
3. Verwijder de bovenste scharnierafdekking (3).

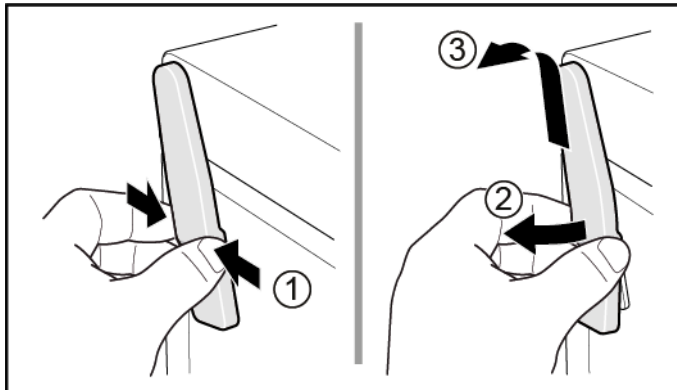

1. Verwijder de afdekking van de aansluitdoos (1).
2. Verwijder de kabelbeschermer (2).
3. Haal de elektrische aansluiting los (3).
4. Draai de twee schroeven los (4).
5. Verwijder het bovenste scharnier (5).

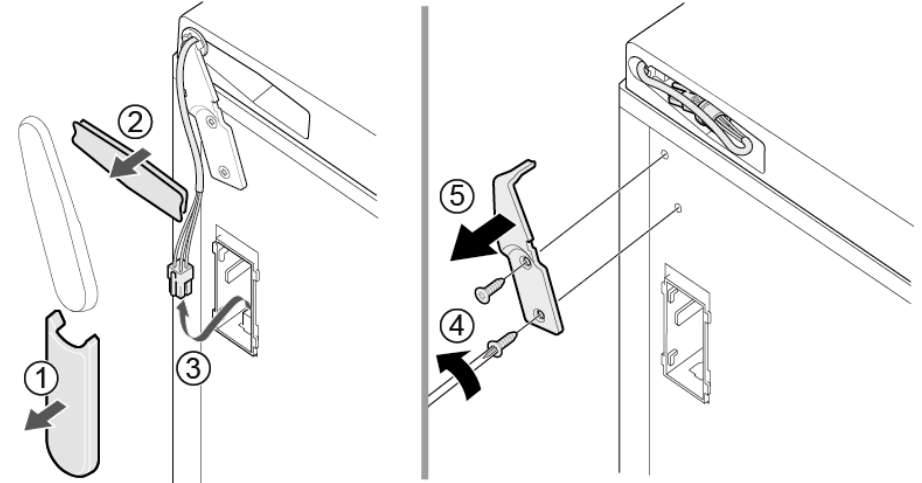

 Het bovenste deurscharnier wordt verwijderd.

### 4.5.2 Deurscharnier monteren

- ▶ Monteer in omgekeerde volgorde.

## 4.6 Onderste deurscharnier vervangen

Speciale hulpmiddelen:

Torxbit TX20

6,3 mm (1/4")

[00340865]

	<b>WAARSCHUWING</b>
	<p><b>Zware, omvangrijke apparaten!</b> Rug- en spierletsel</p> <ul style="list-style-type: none"> <li>▶ De werkzaamheid van het verwijderen van de apparaatdeur mag alleen worden uitgevoerd door speciaal opgeleid personeel.</li> <li>▶ Om het apparaat te verplaatsen zijn twee mensen nodig.</li> <li>▶ Gebruik alleen geschikte gereedschappen en apparatuur.</li> </ul>

	<b>VOORZICHTIG</b>
	<p><b>Scherpe randen!</b> Snijletsel</p> <ul style="list-style-type: none"> <li>▶ Draag veiligheidshandschoenen.</li> </ul>

	<b>WAARSCHUWING</b>
	<p><b>Weggliden van schuin staande apparaten!</b> Botbreuken / beknellingsletsel</p> <ul style="list-style-type: none"> <li>▶ Beveilig apparaten tegen wegglijden.</li> </ul>

	<b>VOORZICHTIG</b>
	<p><b>Gevaar voor vallende onderdelen als gevolg van losgeraakte schroeven!</b> Letsel als gevolg van vallende onderdelen.</p> <ul style="list-style-type: none"> <li>▶ Beveilig component tegen vallen.</li> </ul>

	<b>LET OP!</b>
	<p><b>Gevaar voor vallende onderdelen als gevolg van losgeraakte schroeven!</b> Schade aan andere onderdelen van het apparaat of bij de klant thuis bijvoorbeeld aan de vloer.</p> <ul style="list-style-type: none"> <li>▶ Beveilig component tegen vallen.</li> </ul>

Voorwaarde:

- ✓ Apparaat is losgekoppeld is van de stroomvoorziening.
- ✓ De inwendige hulpstukken van het apparaat worden verwijderd.

- ✓ Het apparaat wordt op zijn achterkant gezet.
- ✓ [Het bovenste scharnier wordt verwijderd. → 105](#)

### 4.6.1 Onderste deurscharnier vervangen

1. Verwijder de deur.

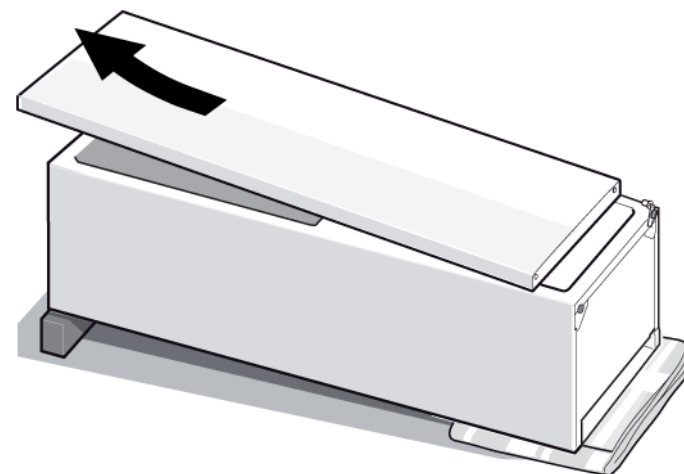

2.
  1. Draai de schroef (1) los.
  2. Draai het onderste scharnier eruit (2).
  3. Verwijder het onderste scharnier (3).

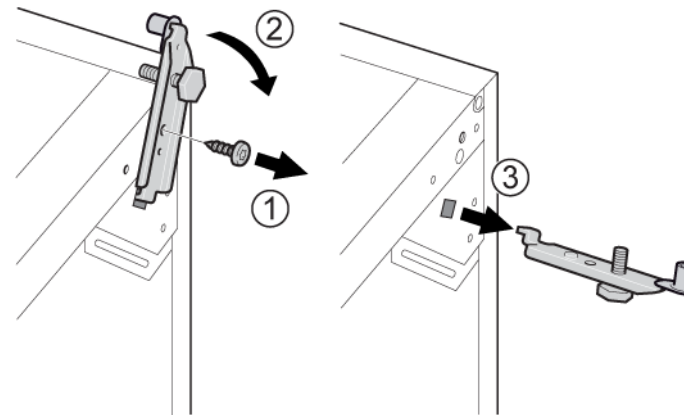

- ➡ Het onderste deurscharnier wordt verwijderd.

### **4.6.2 Onderste deurscharnier monteren**

- ▶ Monteer in omgekeerde volgorde.

## 4.7 Plateau vervangen

Voorwaarde:

- ✔ Deur is open.

### 4.7.1 Plateau verwijderen

- ▶ Trek het plateau eruit.

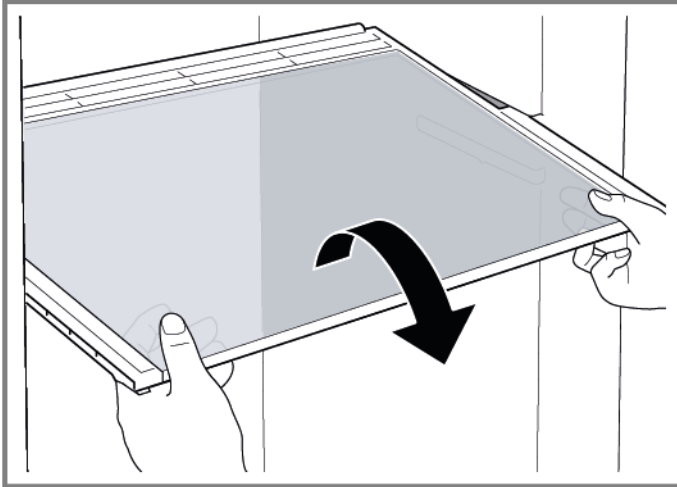

➡ Plateau wordt verwijderd.

### 4.7.2 Plateau monteren

- ▶ Monteer in omgekeerde volgorde.

## 4.8 Vrieslade vervangen

Voorwaarde:

- ✔ Deur is open.

### 4.8.1 Vrieslade verwijderen

- ▶ 1. Trek de vrieslade er helemaal uit (1).
- ▶ 2. Verwijder de vrieslade (2).

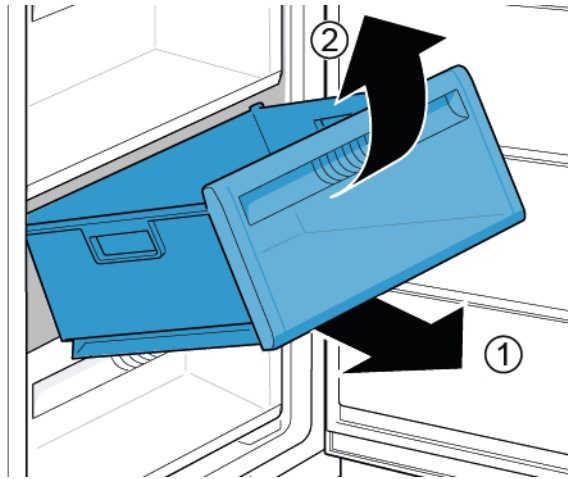

➡ Vrieslade wordt verwijderd.

### 4.8.2 Vrieslade installeren

- ▶ Monteer in omgekeerde volgorde.

## 4.9 IJsbereider vervangen

Voorwaarde:

- ✔ Deur is open.

### 4.9.1 IJsbereider verwijderen

- ▶ 1. Trek de vrieslade met ijsbereider eruit (1).
- ▶ 2. Haal de haken los (2).
- ▶ 3. Verwijder de ijsbereider (3).

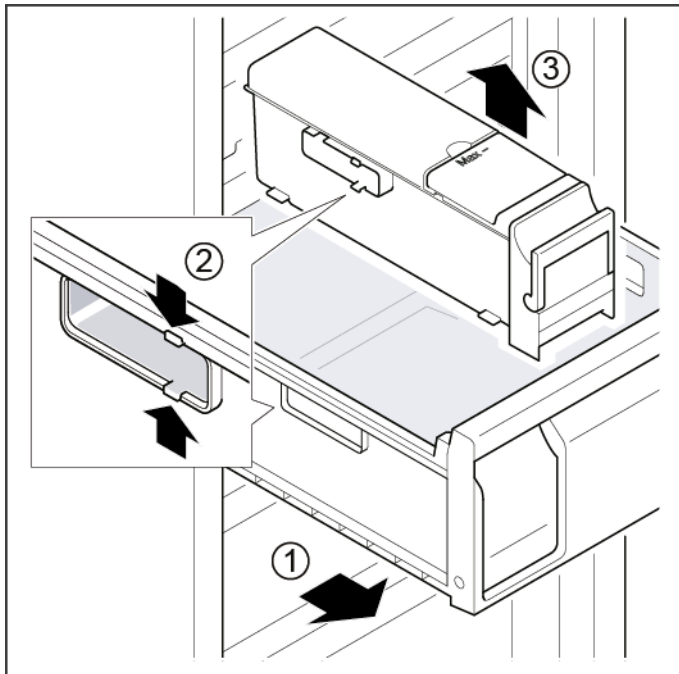

➡ IJsbereider wordt verwijderd.

### 4.9.2 IJsbereider installeren

- ▶ Monteer in omgekeerde volgorde.



## 4.10 LED-bovenlicht vervangen

### Speciale hulpmiddelen:

-  Sleufschroevendraaier      Kop 2,4 mm x 0,4 mm x 60 mm, in de set [00341820]

 Uw apparaat heeft een onderhoudsvrije LED-verlichting. Deze verlichting mag alleen maar door de klantenservice of geautoriseerde monteurs worden vervangen!

 **⚠ GEVAAR**  
**Gevaar voor een elektrische schok aan stroomvoerende onderdelen!**  
Levensgevaar door elektrische schokken in geval van een ondeskundige reparatie

- ▶ Elektrische onderdelen moeten door gekwalificeerde elektriciens worden gerepareerd.
- ▶ Laat na de reparatie een veiligheidstest conform VDE 0701 of de landspecifieke regelgeving uitvoeren.



 **⚠ GEVAAR**  
**Gevaar voor een elektrische schok aan stroomvoerende onderdelen!**  
Dood door elektrocutie

- ▶ Haal apparaten minstens 60 seconden voor u met reparaties begint van de stroomvoorziening af.

 **⚠ VOORZICHTIG**  
**Scherpe randen!**  
Snijletsel

- ▶ Draag veiligheidshandschoenen.

### Voorwaarde:

-  Apparaat is losgekoppeld is van de stroomvoorziening.
-  Deur is open.
-  Het intrieur is verwijderd.

### 4.10.1 LED-verlichting verwijderen

1. Verplaatst de LED-verlichting naar de linkerkant.

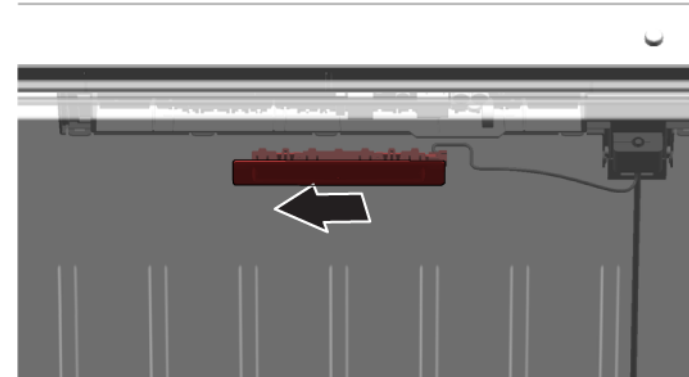

-  De elektrische aansluiting van de LED-verlichting wordt losgemaakt.

2. Haal de haken van de LED-verlichting los.

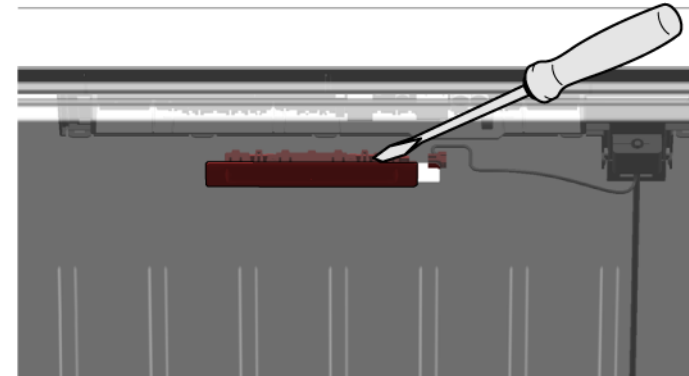

## Reparatie

3. Verwijder de LED-verlichting door het naar voren te bewegen.

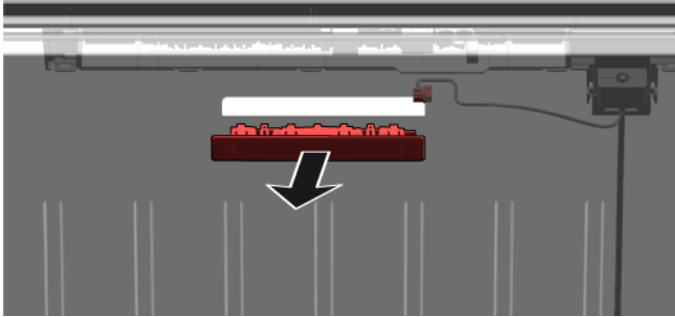





- ➔ LED-verlichting wordt verwijderd.

### 4.10.2 LED-bovenlicht installeren

- ▶ Monteer in omgekeerde volgorde.

# Repair hints - Freezer

 <b>Concerning this document</b> .....	<b>116</b>
1.1 Important information .....	116
1.1.1 Purpose.....	116
1.2 Explanation of symbols .....	116
1.2.1 Danger levels.....	116
1.2.2 Hazard symbols .....	116
1.2.3 Structure of the warnings.....	117
1.2.4 General symbols.....	117
 <b>Safety</b> .....	<b>118</b>
2.1 General Safety instructions .....	118
2.1.1 All domestic appliances .....	118
 <b>Tools and aids</b> .....	<b>119</b>
 <b>Repair</b> .....	<b>120</b>
4.1 Replacing door gasket .....	120
4.1.1 Removing door gasket.....	120
4.1.2 Installing door gasket .....	120
4.2 Replacing door handle .....	123
4.2.1 Removing door handle .....	123
4.2.2 Installing door handle .....	123
4.3 Replacing easy opening handle.....	124
4.3.1 Removing easy opening handle .....	124
4.3.2 Installing easy opening handle .....	124
4.4 Replacing door upper hinge .....	125
4.4.1 Removing door hinge .....	125
4.4.2 Installing door hinge .....	127
4.5 Replacing door upper hinge (door with display) .....	128
4.5.1 Removing door hinge .....	129
4.5.2 Installing door hinge .....	130
4.6 Replacing door lower hinge .....	131
4.6.1 Replacing door lower hinge .....	131
4.6.2 Installing door lower hinge .....	132
4.7 Replacing shelf.....	133
4.7.1 Removing shelf.....	133
4.7.2 Installing shelf.....	133

4.8 Replacing frozen food container.....	134
4.8.1 Removing frozen food container .....	134
4.8.2 Installing frozen food container .....	134
4.9 Replacing ice maker.....	135
4.9.1 Removing ice maker .....	135
4.9.2 Installing ice maker.....	135
4.10 Replacing LED top light.....	136
4.10.1 Removing LED light.....	136
4.10.2 Installing top LED light .....	137

# **i** Concerning this document

## 1.1 Important information

### 1.1.1 Purpose

These repair hints support consumer to repair appliances by himself according to the applicable eco-design regulation (as of 03/2021).

They contain information how to exchange defined spare parts including warnings and risks.

In case of questions, please contact our customer service. We will only be liable for damages if the repair hints have been followed properly.

## 1.2 Explanation of symbols

### 1.2.1 Danger levels

The warning levels consist of a symbol and a signal word. The signal word indicates the severity of the danger.









Warning level	Meaning
	Non-observance of the warning message will result in death or serious injuries.
	Non-observance of the warning message could result in death or serious injuries.
	Non-observance of the warning message could result in minor injuries.
	Non-observance of the warning message could result in damage to property.

Table 1: Danger levels

### 1.2.2 Hazard symbols

Hazard symbols are symbolic representations which give an indication of the kind of danger.

The following hazard symbols are used in this document:

Hazard symbol	Meaning
	General warning message
	Danger from electrical voltage
	Risk of explosion
	Danger of cuts
	Danger of crushing

## **i** Concerning this document



Hazard symbol	Meaning
	Danger from hot surfaces
	Danger from strong magnetic field
	Danger from non-ionizing radiation

Table 2: Hazard symbols

### 1.2.3 Structure of the warnings

Warnings in this document have a standardised appearance and a standardised structure.



	<div style="background-color: red; color: white; padding: 2px; text-align: center;"><b>⚠ Danger</b></div> <p><b>Type and source of danger!</b> Possible consequences of ignoring the danger / warning.</p> <ul style="list-style-type: none"> <li>▶ Measures and prohibitions for preventing the danger.</li> </ul>
--	---

The following example shows a warning that warns against electric shock due to live parts. The measure for avoiding the danger is mentioned.

	<div style="background-color: red; color: white; padding: 2px; text-align: center;"><b>⚠ Danger</b></div> <p><b>Risk of electric shock due to live parts!</b> Death by electrocution</p> <ul style="list-style-type: none"> <li>▶ Disconnect appliances from electrical supply at least 60 seconds before starting repairs.</li> </ul>
---	--

### 1.2.4 General symbols

The following general symbols are used in this document:

Gen. symbol	Meaning
	Identification of a special tip (text and/or graphic)
	Identification of a simple tip (only text)
	Identification of a link to a video tutorial





Gen. symbol	Meaning
	Identification of required tools
	Identification of required preconditions
	Identification of a condition (if ..., then ...)
	Identification of a result
[Start]	Identification of a key or button
[00123456]	Identification of a material number
Status	Identification of displayed text / window (in the appliance's display)

Table 3: General symbols

## 2.1 General Safety instructions

### 2.1.1 All domestic appliances

#### **Risk of electric shock due to live parts!**

- Errors by repairs involving electrical components can lead to electrical shock!
- Disconnect the appliance from the mains for at least 60 seconds before starting work.
- After the repair have a safety test according VDE 0701 or country-specific regulations performed.

#### **Risk of injury from sharp edges!**

- Wear protective gloves.

#### **Risk of crushing during repair, maintenance, troubleshooting and service due to heavy and moving components**

- Wear protective shoes.
- Secure heavy components from falling down.
- Do not stick body parts into moving components.



#### **Risk to the appliance's safety / function!**

- Only use original spare parts.

#### **Risk of damage to electrostatically sensitive components (ESDs)!**

- Do not touch the modules, including connections and conductor paths.

## Tools and aids

Designation	Details	Images
Protection cloth [00342013]	60 cm x 50 cm	
Phillips screwdriver PH2		
Torx Bit TX20 [00340865]	6,3 mm (1/4")	
Slotted screwdriver	Blade 2.4 mm x 0.4 mm x 60 mm, in the kit [00341820]	

## 4.1 Replacing door gasket

### Prerequisite:

-  Door is open.

### 4.1.1 Removing door gasket

1. Release door gasket from the groove on right and left corner.

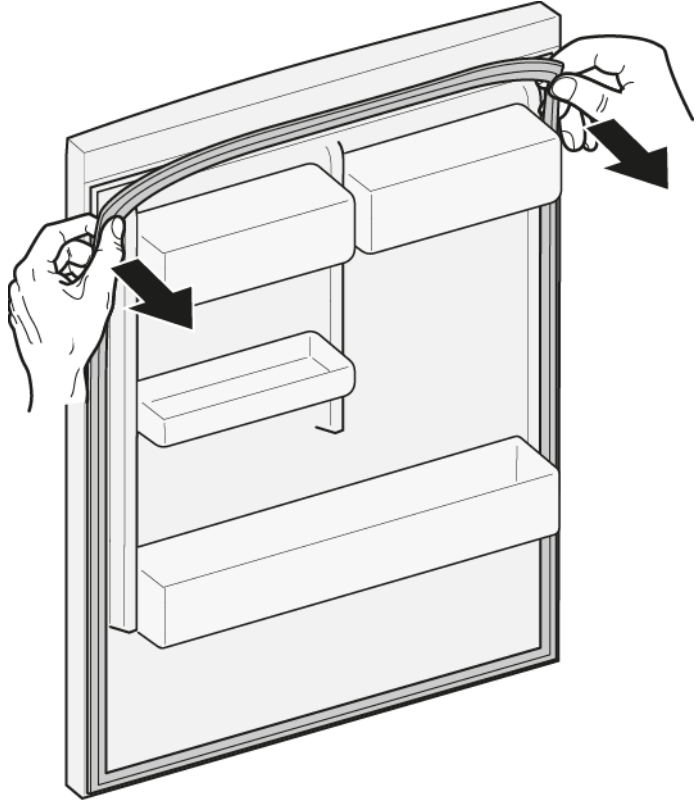

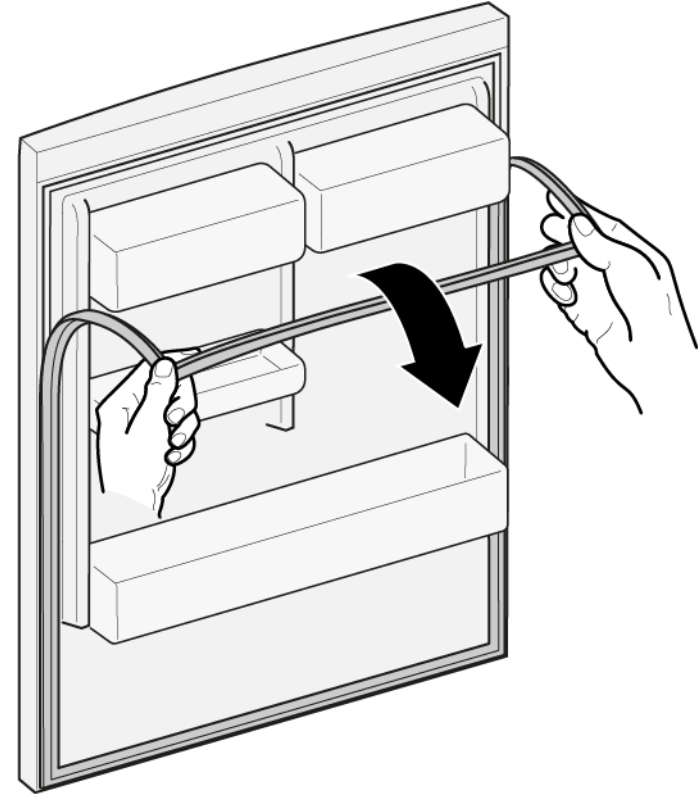

2. Pull out door gasket from groove.



-  Door gasket is removed.

### 4.1.2 Installing door gasket

	Thickness of new door gasket may deviate slightly from thickness of old door gasket. This will not affect closing behavior and long-term function.
	If your appliance has adjustable hinges or hinge attachments, you can optimize the closing behavior subsequently.
	Small side holes in door gasket are functional (required for ventilation). These are not production faults.



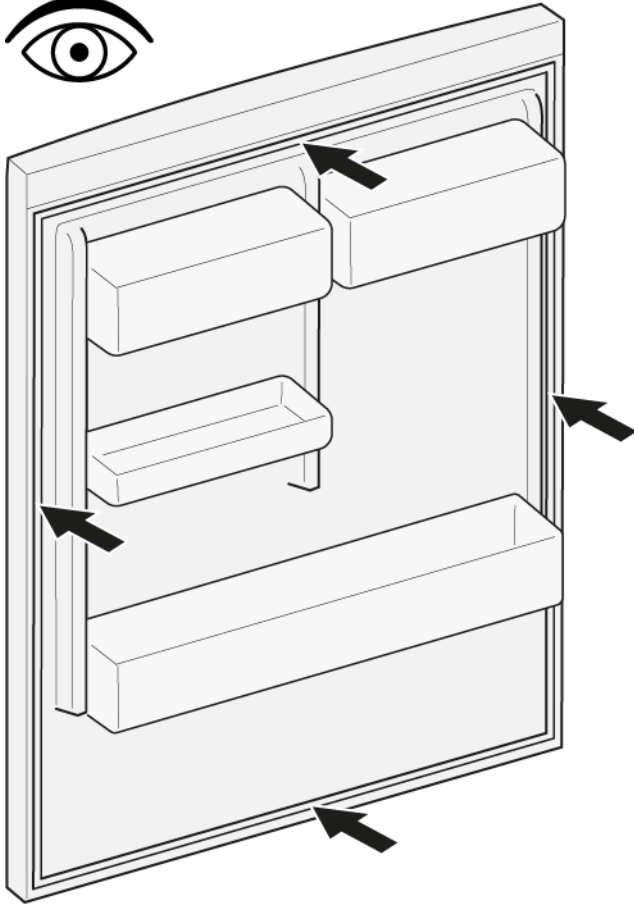

## Repair

1. Check groove for gasket for damage.

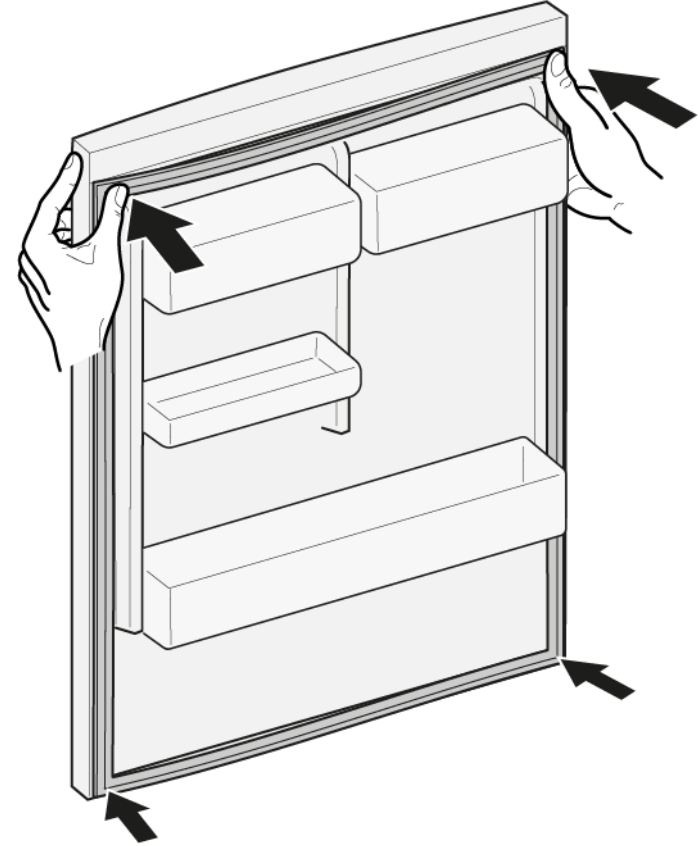

4. Push corners of gasket at the top and bottom to the groove.



2.  If groove for gasket is it is damaged.  
- Contact customer service.

3.  Slight deformation of door gasket is normal and does not affect its function. It is recommended to straighten door gasket before inserting it into appliance.

Heat door gasket with a hair dryer or hot water and manually reshape it.

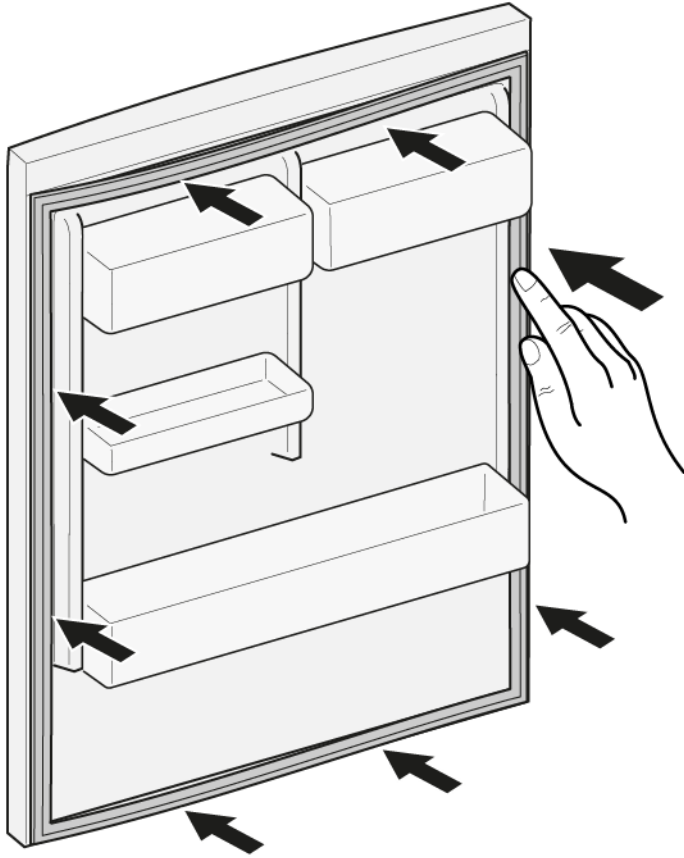

5. Press whole gasket step by step into the groove.





 Door gasket is installed.

## 4.2 Replacing door handle

### Required tools:

-  Torx Bit TX20                      6,3 mm (1/4")                      [00340865]
-  Slotted screwdriver                      Blade 10 mm x 1.6 mm x 200 mm

### Prerequisite:

-  Appliance is disconnected from power supply.
-  Door is open.

### 4.2.1 Removing door handle

- ▶ 1. Remove two screw caps (1).
- ▶ 2. Unscrew two screws (2).
- ▶ 3. Remove door handle (3).

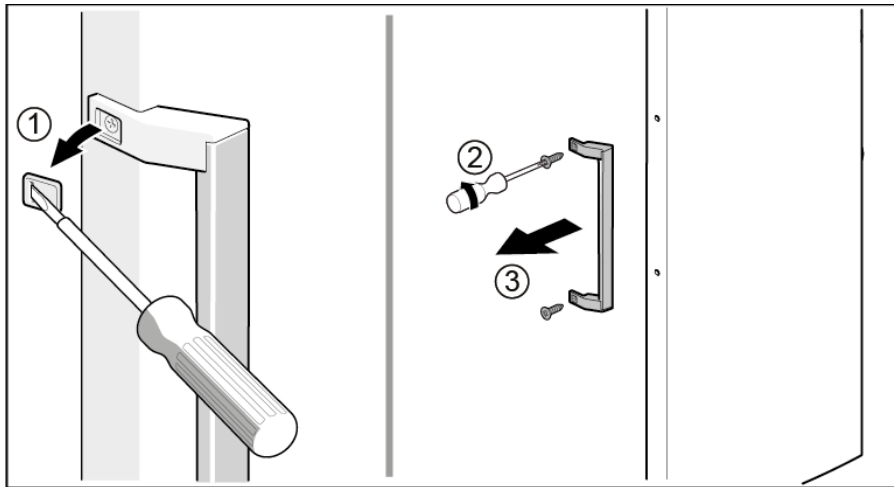

-  Door handle is removed.

### 4.2.2 Installing door handle

- ▶ Install in reverse order.

## 4.3 Replacing easy opening handle

### Required tools:

- ⌘ Phillips screwdriver PH2

### Prerequisite:

- ✔ Appliance is disconnected from power supply.
- ✔ Door is open.

### 4.3.1 Removing easy opening handle

- ▶ 1. Remove easy opening handle cover (1).
- ▶ 2. Unscrew two screws (2).

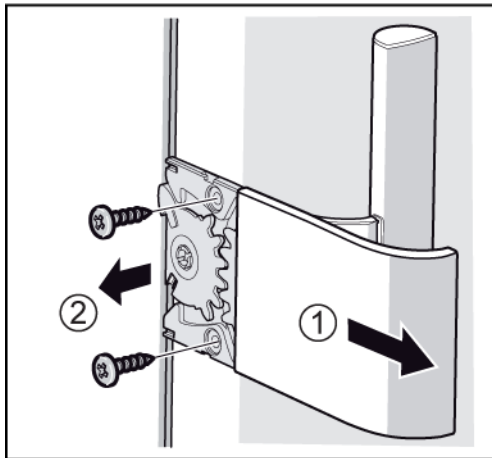

- ➡ Easy opening handle is removed.

## 4.3.2 Installing easy opening handle

Easy opening handle mechanism should be properly set before installation.

Correct arrangement of push rod (1), toothed quadrants (2) and (3), spring (4) and limit stop (5) for the door left side installation is shown on the graphic.

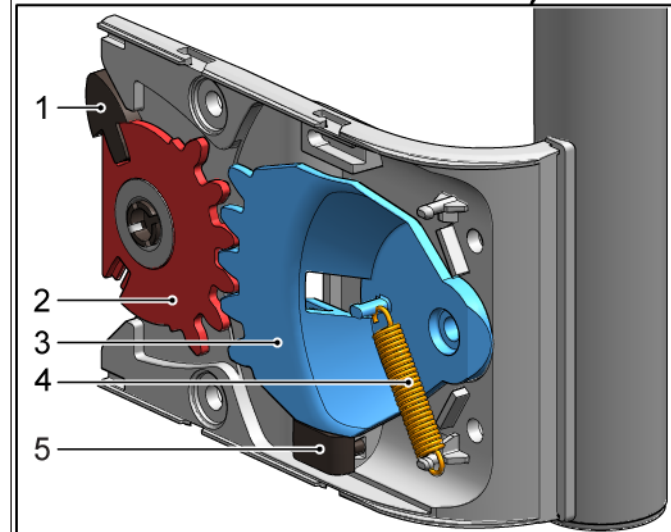
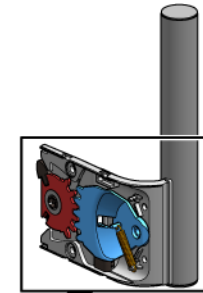



Arrangement of easy opening handle sub-components for door right side installation is described in the document "Installation instruction".

- ▶ Install in reverse order.

## 4.4 Replacing door upper hinge

### Required tools:

 Torx Bit TX20                      6,3 mm (1/4")                      [00340865]

	<b>Warning</b>
	<b>Heavy, bulky appliances!</b> Back and muscle injuries <ul style="list-style-type: none"><li>▶ Appliance door removal operation should only be carried out by trained specialists.</li><li>▶ To move the appliance, two people are required.</li><li>▶ Use only suitable tools and equipment.</li></ul>



	<b>Caution</b>
	<b>Sharp edges!</b> Cut injuries <ul style="list-style-type: none"><li>▶ Wear protective gloves.</li></ul>

	<b>Warning</b>
	<b>Slipping of tilted appliances!</b> Bone fractures / crush injuries <ul style="list-style-type: none"><li>▶ Secure appliances against slipping.</li></ul>

	<b>Caution</b>
	<b>Risk of falling parts due to released screws!</b> Injury because of falling parts. <ul style="list-style-type: none"><li>▶ Secure component from falling down.</li></ul>

	<b>Notice</b>
	<b>Risk of falling parts due to released screws!</b> Damage to other parts of the appliance or at customers home e.g. bottom. <ul style="list-style-type: none"><li>▶ Secure component from falling down.</li></ul>

### Prerequisite:

-  Appliance is disconnected from power supply.
-  Appliance interior fittings are removed.

## 4.4.1 Removing door hinge

# Repair

1. Place appliance on the back side.

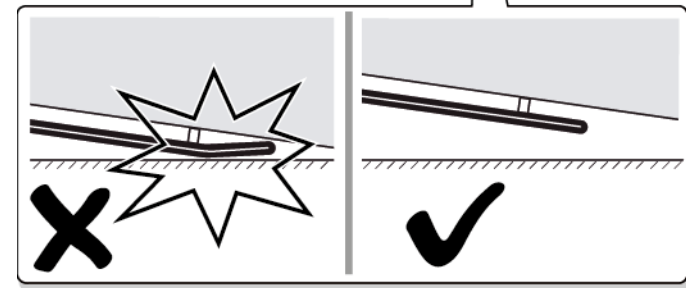
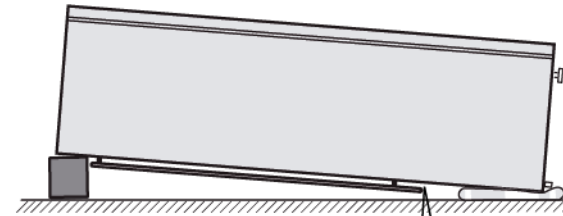
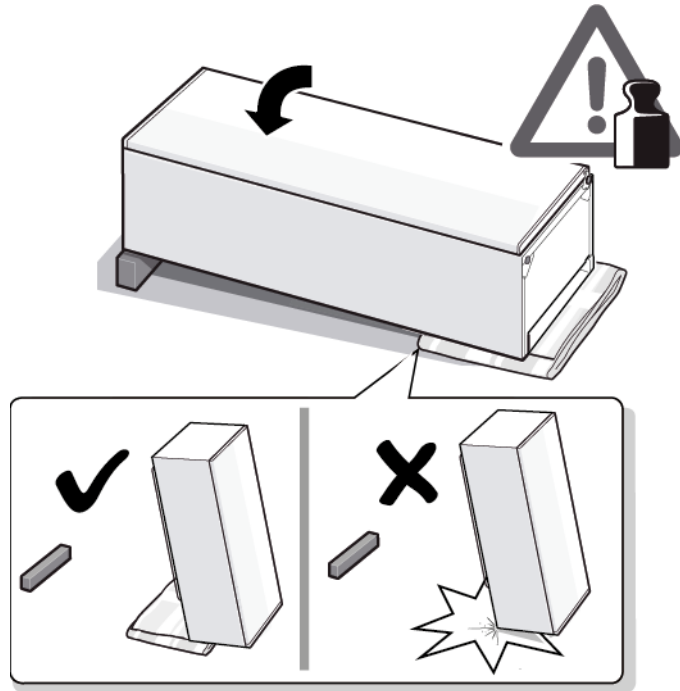

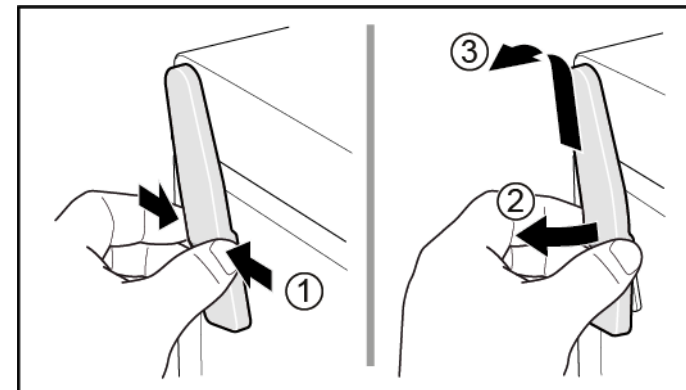

2. 1. Press upper hinge cover on both sides (1).
2. Move out upper hinge cover (2).
3. Remove upper hinge cover (3).

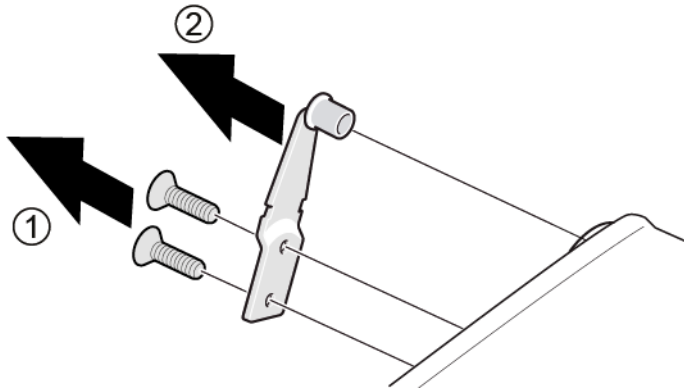

## Repair

3. 1. Unscrew two screws (1).
2. Remove upper hinge (2).



 Door upper hinge is removed.

### 4.4.2 Installing door hinge

- ▶ Install in reverse order.

## 4.5 Replacing door upper hinge (door with display)

### Required tools:

 Torx Bit TX20                      6,3 mm (1/4")                      [00340865]

	<b>Warning</b>
	<p><b>Heavy, bulky appliances!</b> Back and muscle injuries</p> <ul style="list-style-type: none"> <li>▶ Appliance door removal operation should only be carried out by trained specialists.</li> <li>▶ To move the appliance, two people are required.</li> <li>▶ Use only suitable tools and equipment.</li> </ul>

	<b>Caution</b>
	<p><b>Sharp edges!</b> Cut injuries</p> <ul style="list-style-type: none"> <li>▶ Wear protective gloves.</li> </ul>

	<b>Warning</b>
	<p><b>Slipping of tilted appliances!</b> Bone fractures / crush injuries</p> <ul style="list-style-type: none"> <li>▶ Secure appliances against slipping.</li> </ul>



	<b>Caution</b>
	<p><b>Risk of falling parts due to released screws!</b> Injury because of falling parts.</p> <ul style="list-style-type: none"> <li>▶ Secure component from falling down.</li> </ul>

	<b>Notice</b>
	<p><b>Risk of falling parts due to released screws!</b> Damage to other parts of the appliance or at customers home e.g. bottom.</p> <ul style="list-style-type: none"> <li>▶ Secure component from falling down.</li> </ul>

	<b>Danger</b>
	<p><b>Risk of electric shock due to live parts!</b> Danger to life through electric shock in case of improper repair</p> <ul style="list-style-type: none"> <li>▶ Electric parts should be repaired by a qualified electricians.</li> <li>▶ After the repair have a safety test according VDE 0701 or country-specific regulations performed.</li> </ul>

	<b>Danger</b>
	<p><b>Risk of electric shock due to live parts!</b> Death by electrocution</p> <ul style="list-style-type: none"> <li>▶ Disconnect appliances from electrical supply at least 60 seconds before starting repairs.</li> </ul>

### Prerequisite:

-  Appliance is disconnected from power supply.
-  Appliance interior fittings are removed.



### 4.5.1 Removing door hinge

1. Place appliance on the back side.

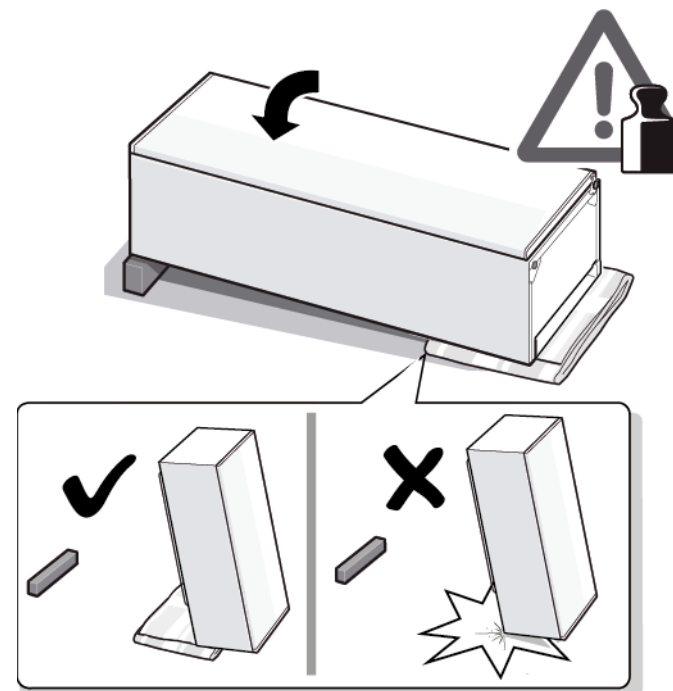

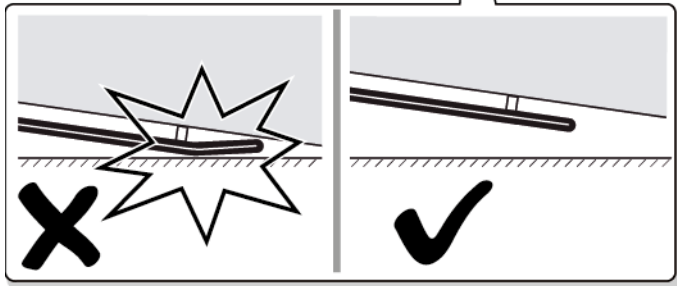
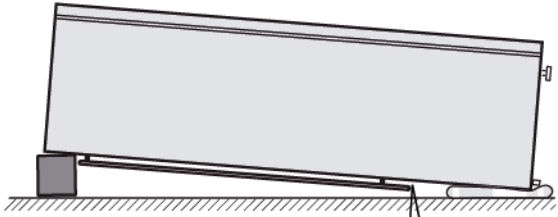

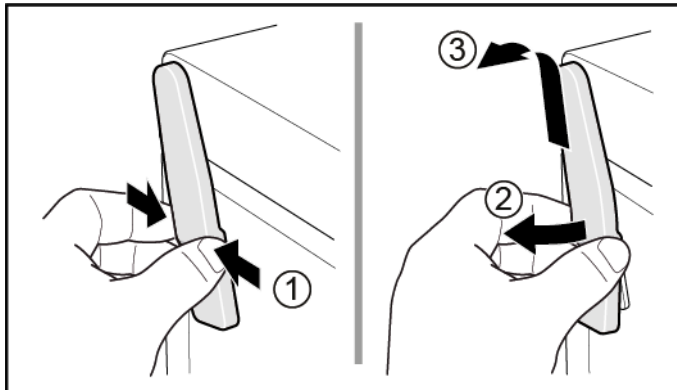

2. 1. Press upper hinge cover on both sides (1).
2. Move out upper hinge cover (2).
3. Remove upper hinge cover (3).

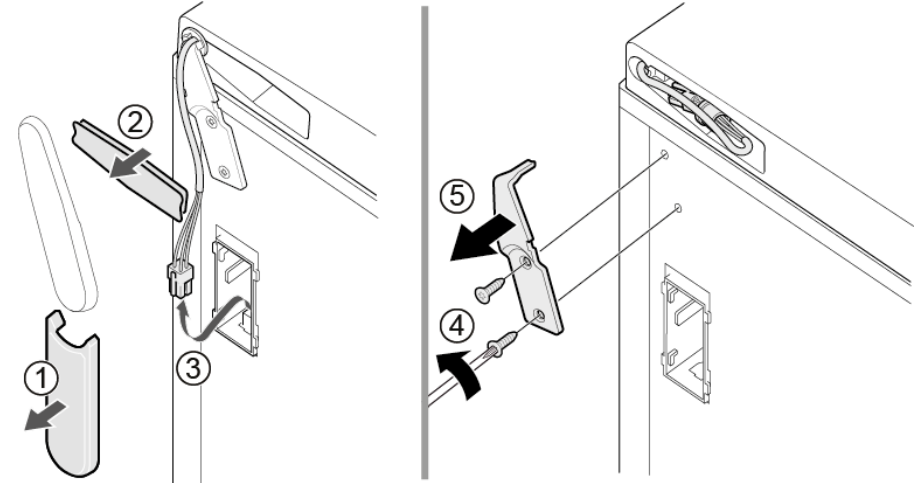

3. 1. Remove cable box cover (1).
2. Remove cable protection (2).
3. Disconnect electrical connection (3).
4. Unscrew two screws (4).
5. Remove upper hinge (5).



 Door upper hinge is removed.





#### 4.5.2 Installing door hinge

- ▶ Install in reverse order.



## 4.6 Replacing door lower hinge

### Required tools:

 Torx Bit TX20                      6,3 mm (1/4")                      [00340865]

	<p style="text-align: center;"><b>Warning</b></p> <p><b>Heavy, bulky appliances!</b> Back and muscle injuries</p> <ul style="list-style-type: none"> <li>▶ Appliance door removal operation should only be carried out by trained specialists.</li> <li>▶ To move the appliance, two people are required.</li> <li>▶ Use only suitable tools and equipment.</li> </ul>
	<p style="text-align: center;"><b>Caution</b></p> <p><b>Sharp edges!</b> Cut injuries</p> <ul style="list-style-type: none"> <li>▶ Wear protective gloves.</li> </ul>
	<p style="text-align: center;"><b>Warning</b></p> <p><b>Slipping of tilted appliances!</b> Bone fractures / crush injuries</p> <ul style="list-style-type: none"> <li>▶ Secure appliances against slipping.</li> </ul>
	<p style="text-align: center;"><b>Caution</b></p> <p><b>Risk of falling parts due to released screws!</b> Injury because of falling parts.</p> <ul style="list-style-type: none"> <li>▶ Secure component from falling down.</li> </ul>
	<p style="text-align: center;"><b>Notice</b></p> <p><b>Risk of falling parts due to released screws!</b> Damage to other parts of the appliance or at customers home e.g. bottom.</p> <ul style="list-style-type: none"> <li>▶ Secure component from falling down.</li> </ul>

### Prerequisite:

-  Appliance is disconnected from power supply.
-  Appliance interior fittings are removed.
-  Appliance is placed on the back side.

 [Upper hinge is removed.→ Page 128](#)

### 4.6.1 Replacing door lower hinge

1. Remove door.

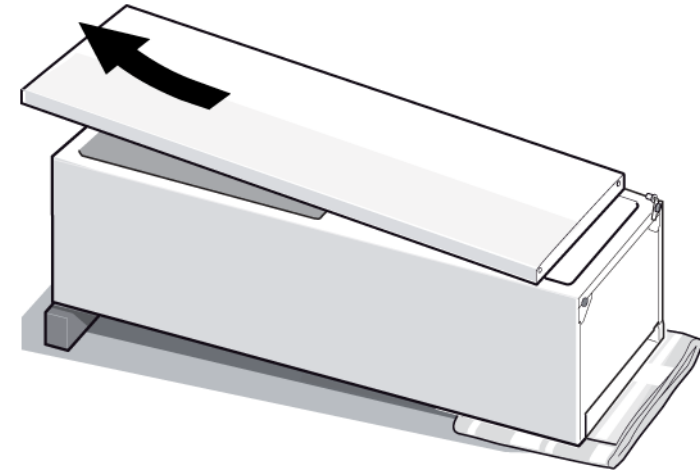

2.
  1. Unscrew the screw (1).
  2. Turn lower hinge out (2).
  3. Remove lower hinge (3).

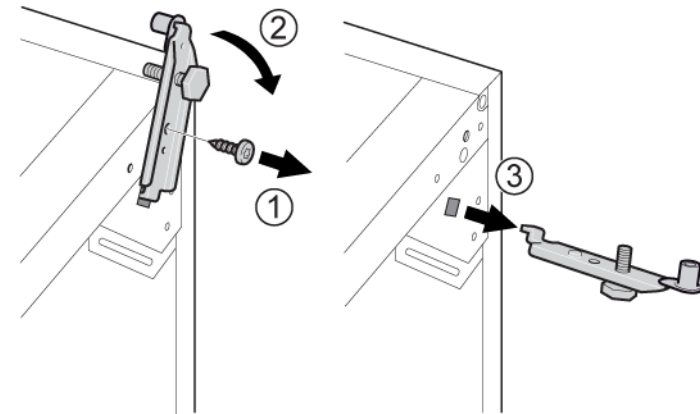

 Lower hinge is removed.

#### **4.6.2 Installing door lower hinge**

- ▶ Install in reverse order.

## 4.7 Replacing shelf

### Prerequisite:

- ✔ Door is open.

### 4.7.1 Removing shelf

- ▶ Pull out shelf.

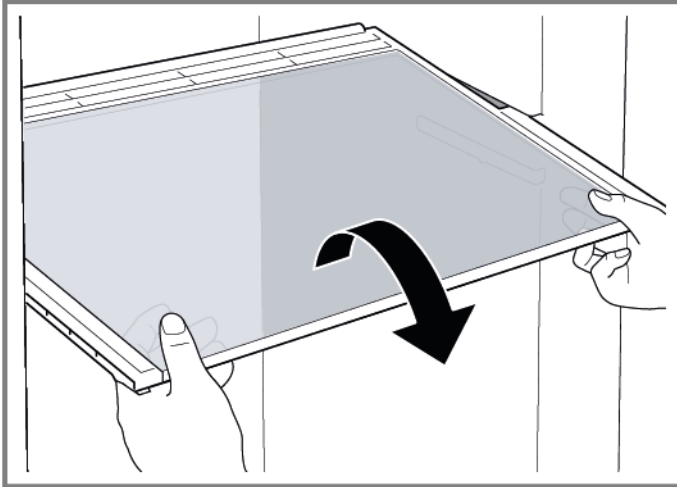

- ➡ Shelf is removed.

### 4.7.2 Installing shelf

- ▶ Install in reverse order.

## 4.8 Replacing frozen food container

### Prerequisite:

- ✔ Door is open.

### 4.8.1 Removing frozen food container

- ▶ 1. Pull out frozen food container all the way (1).
- ▶ 2. Remove frozen food container (2).

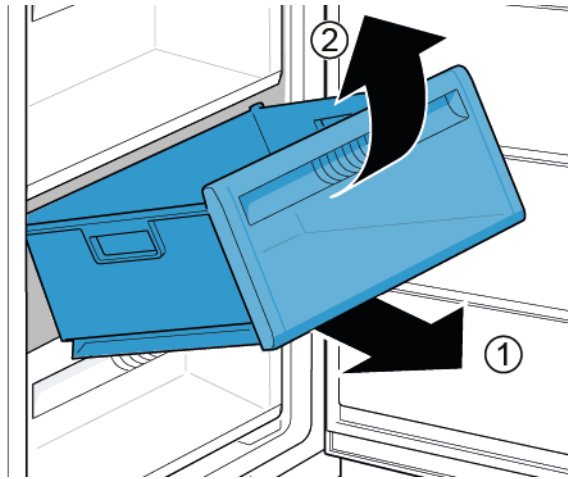

- ➡ Frozen food container is removed.

### 4.8.2 Installing frozen food container

- ▶ Install in reverse order.

## 4.9 Replacing ice maker

### Prerequisite:

- ✔ Door is open.

### 4.9.1 Removing ice maker

- ▶ 1. Pull out shelf frozen food container with ice maker (1).
- ▶ 2. Release hooks (2).
- ▶ 3. Remove ice maker (3).

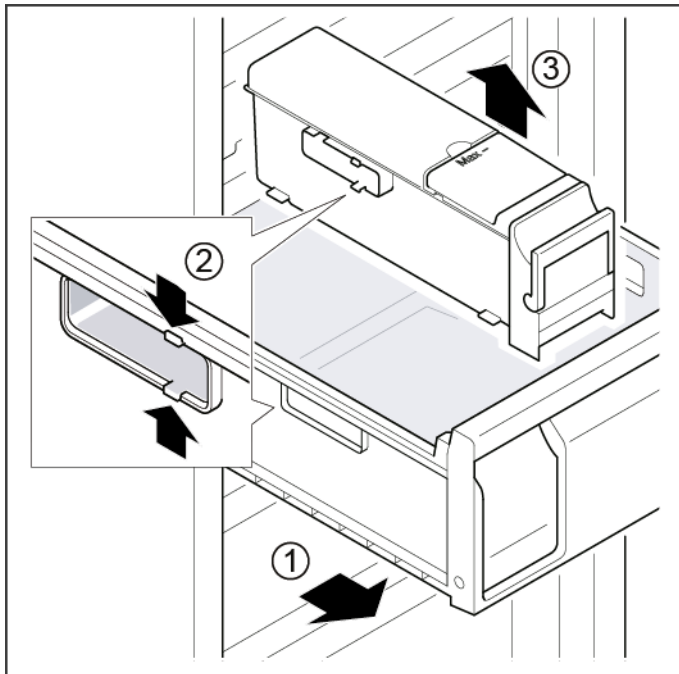

➡ Ice maker is removed.

### 4.9.2 Installing ice maker

- ▶ Install in reverse order.

## 4.10 Replacing LED top light

### Required tools:

-  Slotted screwdriver Blade 2.4 mm x 0.4 mm x 60 mm, in the kit [00341820]

 Your appliance features a maintenance-free LED light. These lights may be repaired by customer service or authorised technicians only!

 **Danger**  
**Risk of electric shock due to live parts!**  
 Danger to life through electric shock in case of improper repair

- ▶ Electric parts should be repaired by a qualified electrician.
- ▶ After the repair have a safety test according VDE 0701 or country-specific regulations performed.



 **Danger**  
**Risk of electric shock due to live parts!**  
 Death by electrocution

- ▶ Disconnect appliances from electrical supply at least 60 seconds before starting repairs.

 **Caution**  
**Sharp edges!**  
 Cut injuries

- ▶ Wear protective gloves.

### Prerequisite:

-  Appliance is disconnected from power supply.
-  Door is open.
-  Upper interior fittings are removed.

### 4.10.1 Removing LED light

1. Move the LED light to the left side.

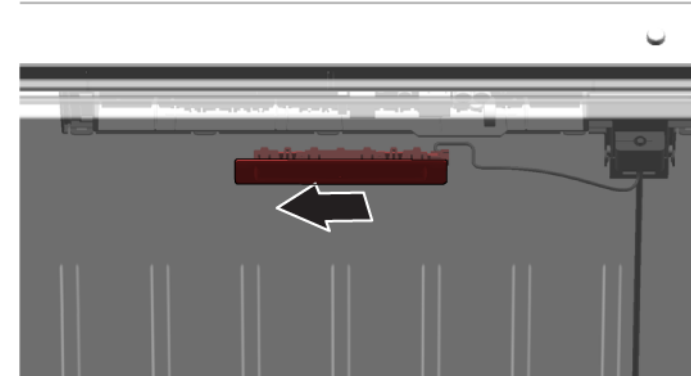

-  LED light electrical connection is disconnected.

2. Release LED light hooks.

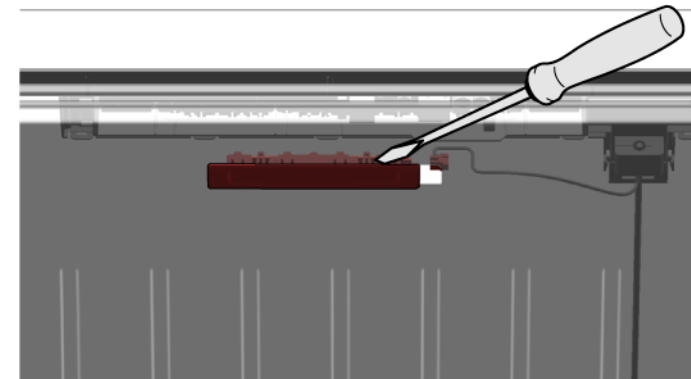



3. Remove LED light moving it forward.

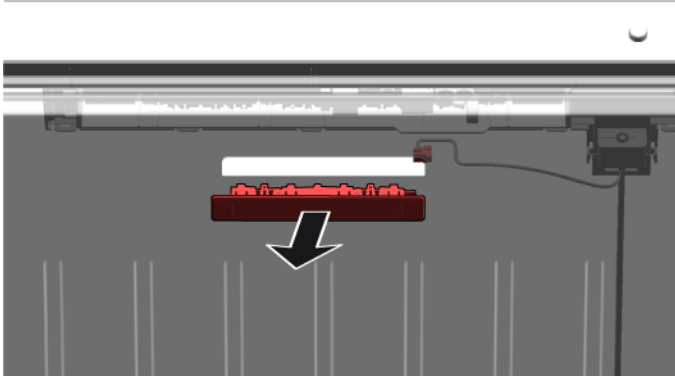



- ➡ LED light is removed.

### 4.10.2 Installing top LED light

- ▶ Install in reverse order.

# Remonditeave - Sügavkülmik

 <b>Selle dokumendiga seoses .....</b>	<b>139</b>
1.1 Tähtis teave .....	139
1.1.1 Eesmärk.....	139
1.2 Sümbolite selgitus .....	139
1.2.1 Ohutasemed.....	139
1.2.2 Ohusümbolid .....	139
1.2.3 Hoiatuste struktuur.....	140
1.2.4 Üldised sümbolid.....	140
 <b>Ohutus.....</b>	<b>141</b>
2.1 Üldised ohutusjuhised.....	141
2.1.1 Kõik kodumasinad.....	141
 <b>Tööriistad ja abinõud.....</b>	<b>142</b>
 <b>Remont.....</b>	<b>143</b>
4.1 Uksetihendi vahetamine.....	143
4.1.1 Uksetihendi eemaldamine .....	143
4.1.2 Uksetihendi paigaldamine.....	143
4.2 Käepideme vahetamine .....	146
4.2.1 Käepideme eemaldamine .....	146
4.2.2 Käepideme paigaldamine .....	146
4.3 Lihtsalt avatava käepideme easy opening handle vahetamine.....	147
4.3.1 Lihtsalt avatava käepideme easy opening handle eemaldamine.....	147
4.3.2 Lihtsalt avatava käepideme easy opening handle paigaldamine.....	147
4.4 Ülemise uksehinge vahetamine .....	148
4.4.1 Uksehinge eemaldamine .....	148
4.4.2 Uksehinge paigaldamine .....	150
4.5 Ülemise uksehinge vahetamine (uks koos kuvaga).....	151
4.5.1 Uksehinge eemaldamine .....	152
4.5.2 Uksehinge paigaldamine .....	153
4.6 Alumise uksehinge vahetamine .....	154
4.6.1 Alumise uksehinge vahetamine.....	154
4.6.2 Alumise uksehinge paigaldamine .....	154
4.7 Riiuli vahetamine .....	155
4.7.1 Riiuli eemaldamine.....	155
4.7.2 Riiuli paigaldamine .....	155

4.8 Külmutatud toidu mahuti vahetamine.....	156
4.8.1 Külmutatud toidu mahuti eemaldamine .....	156
4.8.2 Külmutatud toidu mahuti paigaldamine .....	156
4.9 Jääkuubikute resti vahetamine.....	157
4.9.1 Jääkuubikute resti eemaldamine .....	157
4.9.2 Jääkuubikute resti paigaldamine.....	157
4.10 Ülemise LED-tule vahetamine.....	158
4.10.1 LED-tule eemaldamine .....	158
4.10.2 Ülemise LED-tule paigaldamine.....	159

# **i** Selle dokumendiga seoses

## 1.1 Tähtis teave

### 1.1.1 Eesmärk

Need remondinõuanded toetavad tarbijat seadmete iseseisval remontimisel vastavalt kehtivale ökodisaini määrusele (03/2021).





Need sisaldavad teavet selle kohta, kuidas vahetada teatud varuosi, samuti hoiatusi ning ohtusid.

Küsimuste korral võtke ühendust meie klienditeenindusega. Meie vastutame kahjustuste eest ainult siis, kui remondinõuandeid on õigesti järgitud.

## 1.2 Sümbolite selgitus

### 1.2.1 Ohutasemed

Ohutasemed koosnevad sümbolist ja märksõnast. Märksõna viitab ohu raskusastmele.



Hoiatustase	Tähendus
 <b>OHT</b>	Hoiatusteadete eiramine põhjustab surma või raskeid kehavigastusi.
 <b>HOIATUS</b>	Hoiatusteadete eiramine võib põhjustada surma või raskeid kehavigastusi.
 <b>ETTEVAATUST!</b>	Hoiatusteadete eiramine võib põhjustada kergeid kehavigastusi.
 <b>TÄHELEPANU!</b>	Hoiatusteadete eiramine võib põhjustada varakahju.

Tabel 1: Ohutasemed



### 1.2.2 Ohusümbolid

Ohusümbolid on sümboolsed kujutised, mis viitavad ohu laadile.

Selles dokumendis kasutatakse alljärgnevaid ohusümboleid.

Ohusümbol	Tähendus
	Üldine ohuteade
	Elektripingest tingitud oht
	Plahvatusoht
	Lõikeoht
	Muljumisoht

## **i** Selle dokumendiga seoses

Ohusümbol	Tähendus
	Kuumadest pindadest tingitud oht
	Tugevast magnetväljast tingitud oht
	Mitteioniseerivast kiirgusest tingitud oht

Tabel 2: Ohusümbolid

### 1.2.3 Hoiatuste struktuur

Selles dokumendis olevatel hoiatustel on standardiseeritud väljanägemine ja standardiseeritud struktuur.



	<div style="background-color: red; color: white; padding: 2px; display: inline-block;"><b>⚠ OHT</b></div> <b>Ohu tüüp ja allikas!</b> Ohu/hoiatuse eiramise võimalikud tagajärjed. ▶ Meetmed ja ettevaatusabinõud ohu vältimiseks.
--	---





Alljärgnevas näiteks on näidatud hoiatust, millega hoiatatakse liikuvatest osadest tingitud elektrilöögiu eest. Nimetatud on meetet ohu vältimiseks.

	<div style="background-color: red; color: white; padding: 2px; display: inline-block;"><b>⚠ OHT</b></div> <b>Liikuvatest osadest tingitud elektrilöögi oht!</b> Elektrilöögist tingitud surm ▶ Enne remonditöödega alustamist ühendage seadmed elektrivõrgust lahti vähemalt 60 sekundit varem.
---	--

### 1.2.4 Üldised sümbolid

Selles dokumendis kasutatakse alljärgnevaid üldisi sümboleid.

Üld. sümbol	Tähendus
	Erinõuande tunnus (tekst ja/või graafik)
	Lihtsa nõuande tunnus (ainult tekst)
	Videojuhendi lingi tunnus

Üld. sümbol	Tähendus
	Vajalike tööriistade tunnus
	Vajalike eeltingimuste tunnus
	Seisukorra tunnus (kui..., siis...)
	Tulemuse tunnus
[Start]	Klahvi või nupu tunnus
[00123456]	Materjalinumbri tunnus
Olek	Kuvatava teksti/akna tunnus (seadme ekraanil)

Tabel 3: Üldised sümbolid

## 2.1 Üldised ohutusjuhised

### 2.1.1 Kõik kodumasinad

#### **Liikuvatest osadest tingitud elektrilöögi oht!**

- Elektriliste osade remondil tehtud vead võivad põhjustada elektrilööki!
- Lahutage seade vooluvõrgust vähemalt 60 sekundit enne tööle hakkamist.
- Pärast remonti peab olema tehtud ohutuskatse vastavalt standardile VDE 0701 või riiklikele määrustele.

#### **Teravatest servadest tingitud vigastusoht!**

- Kandke kaitsekindaid.

#### **Rasketest ja liikuvatest osadest tingitud muljumisoht remondi-, puhastustööde, tõrkeotsingu ja hoolduse käigus**

- Kandke turvakingi.
- Kinnitage rasked osad allakukkumise vastu.
- Ärge toppige kehaosi liikuvate osade vahele.



#### **Oht seadme ohutusele/talitlusele!**

- Kasutage ainult originaalvaruosasid.

#### **Elektrostaatiliselt tundlike osade (ESD) kahjustamise oht!**

- Ärge puudutage moduleid, kaasa arvatud ühendusi ega transportöörlinte.

## Tööriistad ja abinõud

Määramine	Üksikasjad	Kujutised
Kaitseriie [00342013]	60 cm × 50 cm	
Ristpeaga kruvi- keeraja PH2		
Tähtotsik TX20 [00340865]	6,3 mm (1/4 tolli)	
Lapik kruvikeeraja	Tera 2,4 mm × 0,4 mm × 60 mm, komplektis [00341820]	

## 4.1 Uksetihendi vahetamine

Nõue:

- ✓ Uks on lahti.

### 4.1.1 Uksetihendi eemaldamine

1. Vabastage uksetihend soonest paremast ja vasakust nurgast.





2. Tõmmake uksetihend soonest välja.





- ➡ Uksetihend on eemaldatud.

### 4.1.2 Uksetihendi paigaldamine

	Uue uksetihendi paksus võib veidi erineda vana tihendi paksusest. See ei mõjuta ukse sulgemist ja pikaajalist tööd.
	Kui teie seadmel on reguleeritavad hinged või hingekinnitused, saate sulgemismehhanismi hiljem sobivaks sättida.
	Väikesed augud uksetihendis on vajalikud õhutuseks. Need ei ole tootmisvead.

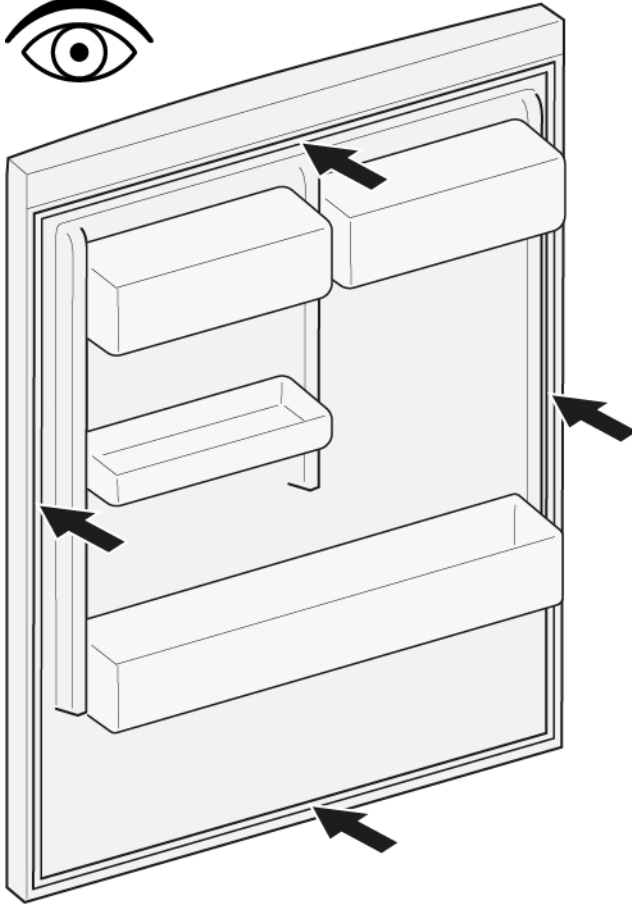
1. Kontrollige, kas tihendi soon on terve.



2.  Kui tihendi soon on kahjustatud,  
- pöörduge klienditeeninduse poole.

3.  Uksetihendi kerge kõverdumine on normaalne ega mõjuta selle toimivust. Soovitav on uksetihend enne seadmesse paigaldamist sirgu tõmmata.

Soojendage uksetihendit fööni või sooja veega ja vormige seda käsitsi.

4. Lükake tihendi otsad soone üla- ja alanurka.

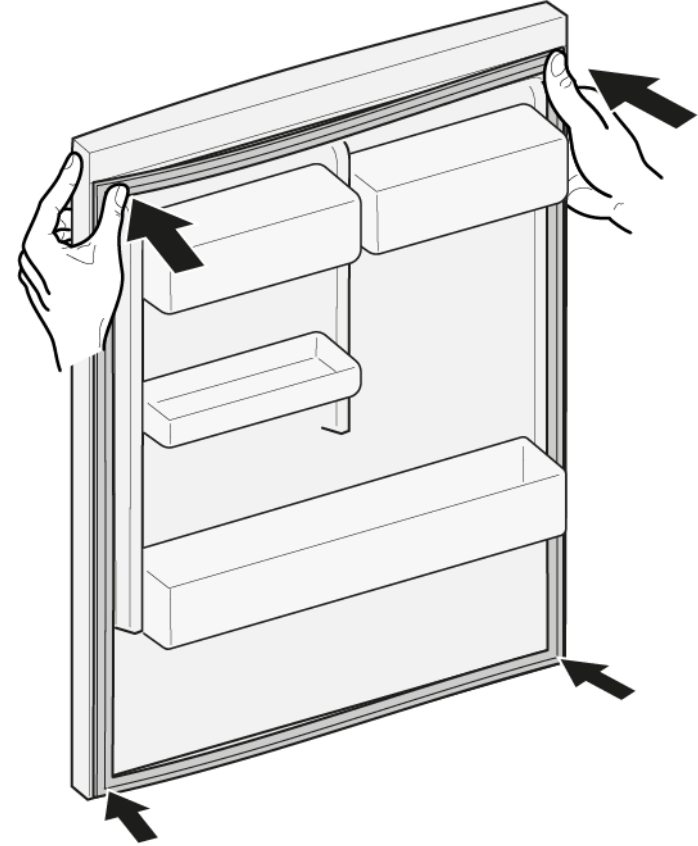



5. Vajutage terve tihend jupphaaval soonde.



➡ Uksetihend on paigaldatud.

## 4.2 Käepideme vahetamine

### Eritööriistad:

- ☞ Tähtsük TX20 6,3 mm (1/4 tolli) [00340865]
- ☞ Lapik kruvikeeraja Tera 10 mm × 1,6 mm × 200 mm

### Nõue:

- ✔ Seade on toitest lahutatud.
- ✔ Uks on lahti.

### 4.2.1 Käepideme eemaldamine

- ▶ 1. Eemaldage kaks kruvikatet (1).
- ▶ 2. Keerake lahti kaks kruvi (2).
- ▶ 3. Eemaldage käepide (3).

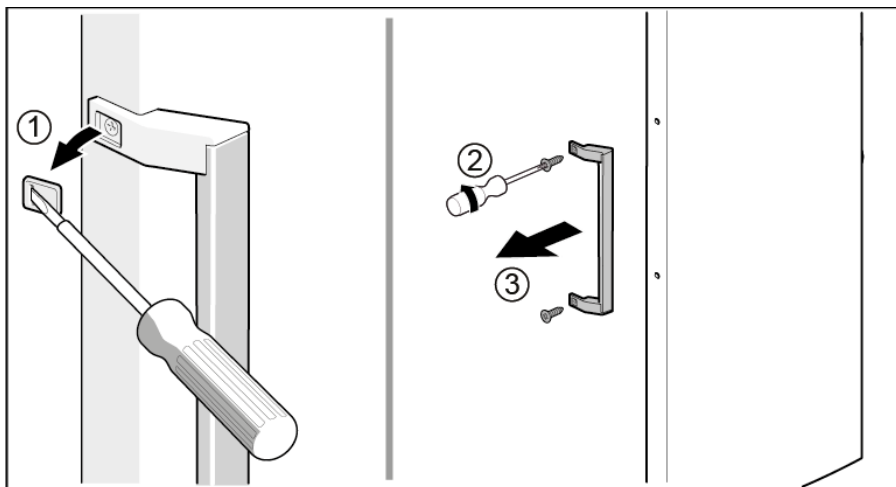

- ➡ Ukse käepide on eemaldatud.

### 4.2.2 Käepideme paigaldamine



- ▶ Paigaldage vastupidises järjekorras.

### 4.3 Lihtsalt avatava käepideme easy opening handle vahetamine

**Eritööriistad:**

-  Ristpeaga kruvikeeraja PH2

**Nõue:**

-  Seade on toitest lahutatud.
-  Uks on lahti.

#### 4.3.1 Lihtsalt avatava käepideme easy opening handle eemaldamine

- ▶ 1. Eemaldage lihtsalt avatava käepideme easy opening handle kate (1).
- ▶ 2. Keerake lahti kaks kruvi (2).

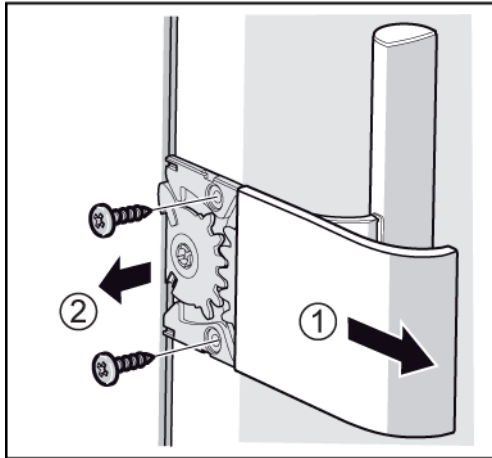

-  Lihtsalt avatav käepide easy opening handle on eemaldatud.

#### 4.3.2 Lihtsalt avatava käepideme easy opening handle paigaldamine

Lihtsalt avatava käepideme easy opening handle mehhanism tuleb enne paigaldamist õigesti paika sättida. Tõukurvarda (1), hammaskvadrantide (2) ja (3), vedru (4) ning käigupiiriku (5) õige korraldus ukse vasakpoolse paigalduse korral on näha joonisel.

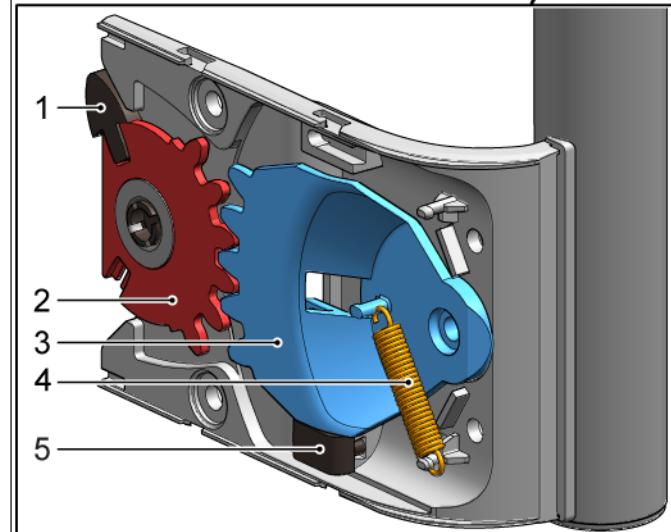
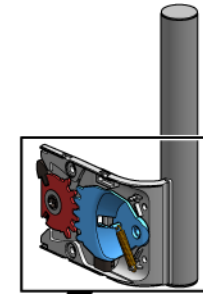

Lihtsalt avatava käepideme easy opening handle allosade korraldus ukse parempoolse paigalduse korral on toodud paigaldusjuhistes.

- ▶ Paigaldage vastupidises järjekorras.

## 4.4 Ülemise uksehinge vahetamine

### Eritööriistad:

Tähtotsik TX20

6,3 mm (1/4 tolli)

[00340865]

	<p><b>⚠ HOIATUS</b></p> <p><b>Rasked, kogukad seadmed!</b> Selja- ja lihasevigastused</p> <ul style="list-style-type: none"><li>▶ Seadme ust tohivad eemaldada vaid vastava väljaõppe saanud spetsialistid.</li><li>▶ Seadme liigutamiseks on vaja kaht inimest.</li><li>▶ Kasutage vaid sobivaid tööriistu ja varustust.</li></ul>
	<p><b>⚠ ETTEVAATUST!</b></p> <p><b>Teravad servad!</b> Lõikehaavad</p> <ul style="list-style-type: none"><li>▶ Kandke kaitsekindaid.</li></ul>
	<p><b>⚠ HOIATUS</b></p> <p><b>Viltuses asendis seadmete libisemisoht!</b> Luumurrud/muljumised</p> <ul style="list-style-type: none"><li>▶ Kindlustage seadmed libisemise vastu.</li></ul>
	<p><b>⚠ ETTEVAATUST!</b></p> <p><b>Lahtikeeratud poltidest tingitud osade kukkumisoht!</b> Kukkuvatest osadest tingitud vigastused.</p> <ul style="list-style-type: none"><li>▶ Kinnitage osa allakukkumise vastu.</li></ul>
	<p><b>TÄHELEPANU!</b></p> <p><b>Lahtikeeratud poltidest tingitud osade kukkumisoht!</b> Seadme teiste osade kahjustused või klientide vara kahjustused.</p> <ul style="list-style-type: none"><li>▶ Kinnitage osa allakukkumise vastu.</li></ul>

### Nõue:

- ✔ Seade on toitest lahutatud.
- ✔ Seadme sisearmatuur on eemaldatud.

## 4.4.1 Uksehinge eemaldamine

1. Pange seade tagaküljele.

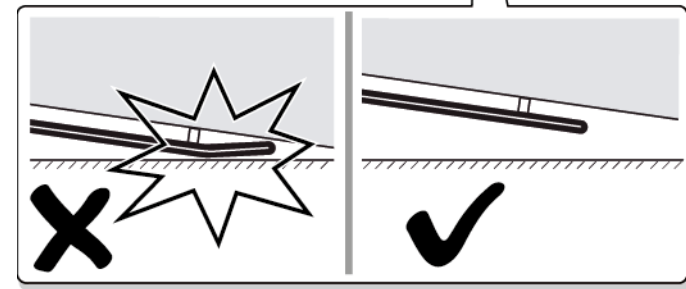
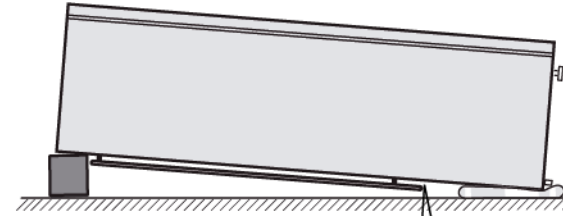
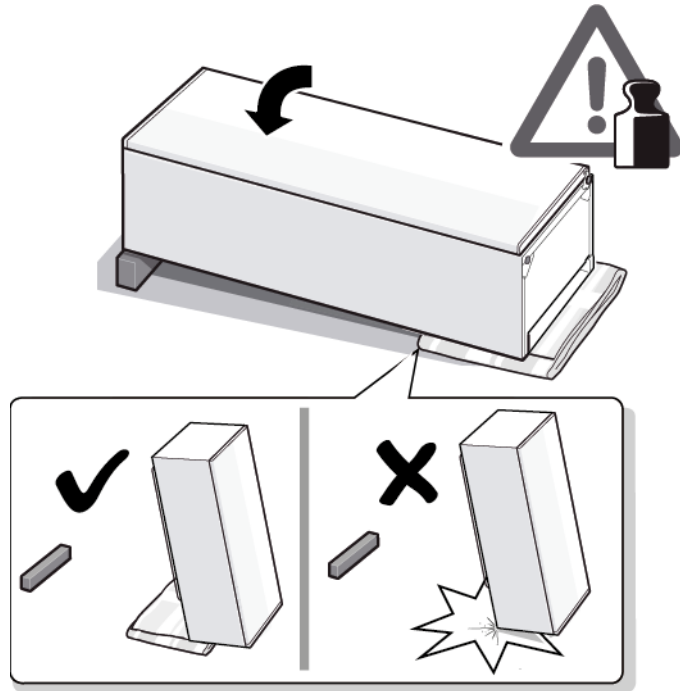

2. 1. Vajutage ülemise hinge katet mõlemal pool (1).  
2. Nihutage ülemise hinge kate välja (2).  
3. Eemaldage ülemise hinge kate (3).

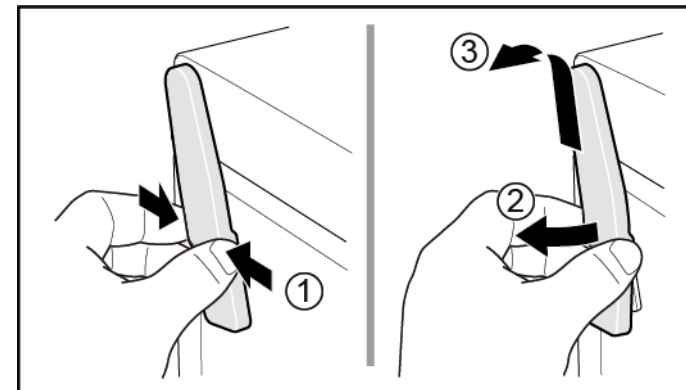

## Remont

3. 1. Keerake lahti kaks kruvi (1).
2. Eemaldage ülemine hing (2).

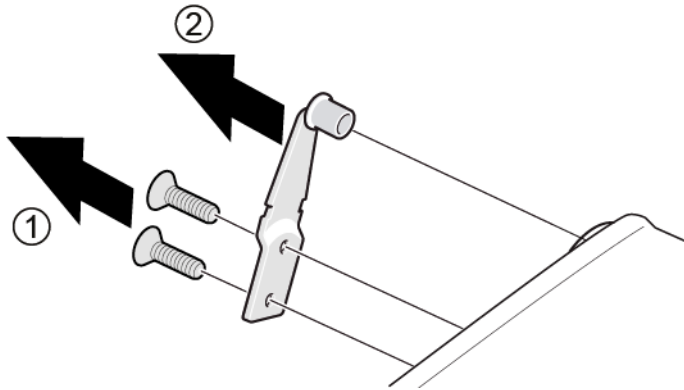

 Ülemine uksehing on eemaldatud.

### 4.4.2 Uksehinge paigaldamine

- ▶ Paigaldage vastupidises järjekorras.

## 4.5 Ülemise uksehinge vahetamine (uks koos kuvaga)

### Eritööriistad:

Tähtotsik TX20

6,3 mm (1/4 tolli)

[00340865]

	<b>HOIATUS</b> <b>Masked, kogukad seadmed!</b> Selja- ja lihasevigastused <ul style="list-style-type: none"><li>▶ Seadme ust tohivad eemaldada vaid vastava väljaõppe saanud spetsialistid.</li><li>▶ Seadme liigutamiseks on vaja kaht inimest.</li><li>▶ Kasutage vaid sobivaid tööriistu ja varustust.</li></ul>
	<b>ETTEVAATUST!</b> <b>Teravad servad!</b> Lõikehaavad <ul style="list-style-type: none"><li>▶ Kandke kaitsekindaid.</li></ul>
	<b>HOIATUS</b> <b>Viltuses asendis seadmete libisemisoht!</b> Luumurrud/muljumised <ul style="list-style-type: none"><li>▶ Kindlustage seadmed libisemise vastu.</li></ul>
	<b>ETTEVAATUST!</b> <b>Lahtikeeratud poltidest tingitud osade kukkumisoht!</b> Kukkuvatest osadest tingitud vigastused. <ul style="list-style-type: none"><li>▶ Kinnitage osa allakukkumise vastu.</li></ul>
	<b>TÄHELEPANU!</b> <b>Lahtikeeratud poltidest tingitud osade kukkumisoht!</b> Seadme teiste osade kahjustused või klientide vara kahjustused. <ul style="list-style-type: none"><li>▶ Kinnitage osa allakukkumise vastu.</li></ul>

	<b>OHT</b> <b>Liikuvatest osadest tingitud elektrilöögi oht!</b> Kui remonditööd on valesti tehtud, esineb elektrilöögist tingitud eluohu. <ul style="list-style-type: none"><li>▶ Elektrilisi osasid peavad parandama kvalifitseeritud elektrikud.</li><li>▶ Pärast remonti peab olema tehtud ohutuskatse vastavalt standardile VDE 0701 või riiklikele määrustele.</li></ul>
---	--

	<b>OHT</b> <b>Liikuvatest osadest tingitud elektrilöögi oht!</b> Elektrilöögist tingitud surm <ul style="list-style-type: none"><li>▶ Enne remonditöödega alustamist ühendage seadmed elektrivõrgust lahti vähemalt 60 sekundit varem.</li></ul>
---	--

### Nõue:

- ✓ Seade on toitest lahutatud.
- ✓ Seadme sisearmatuur on eemaldatud.

## 4.5.1 Uksehinge eemaldamine

1. Pange seade tagaküljele.

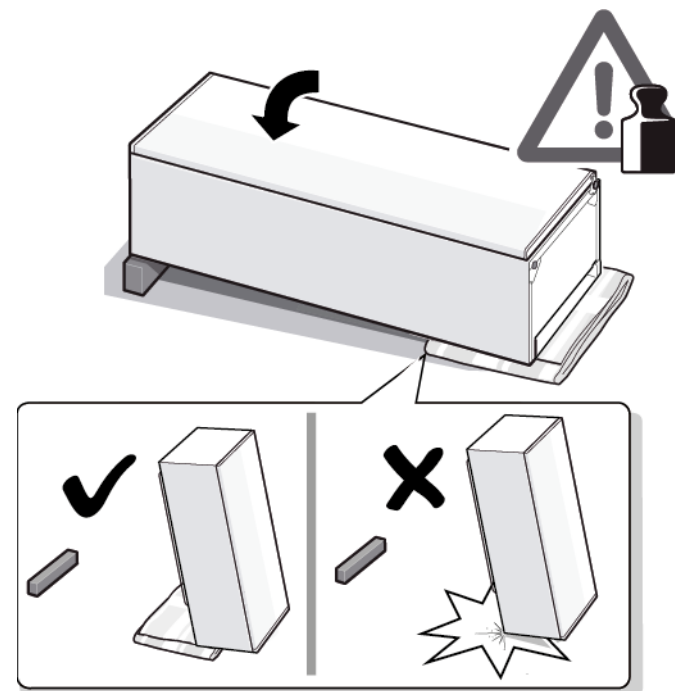



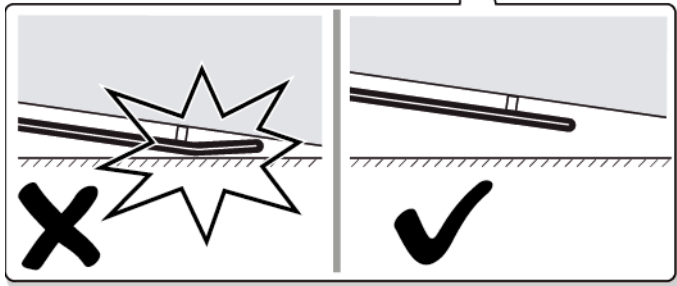
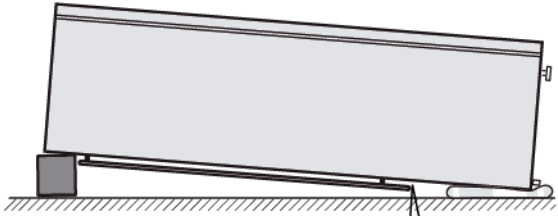

2. 1. Vajutage ülemise hinge katet mõlemal pool (1).
2. Nihutage ülemise hinge kate välja (2).
3. Eemaldage ülemise hinge kate (3).

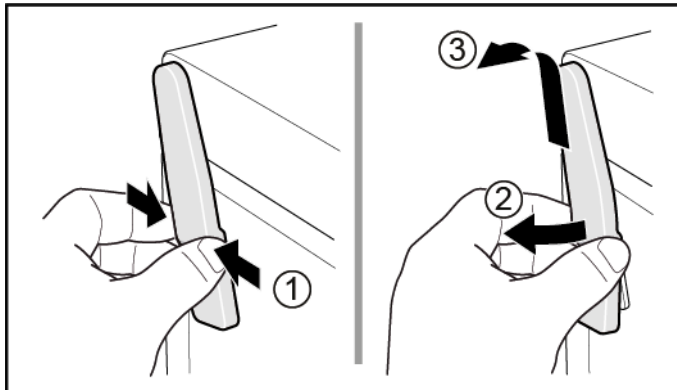

3. 1. Eemaldage kaablikarbi kate (1).
2. Eemaldage kaablikaitse (2).
3. Lahutage elektriühendus (3).
4. Keerake lahti kaks kruvi (4).
5. Eemaldage ülemine hing (5).

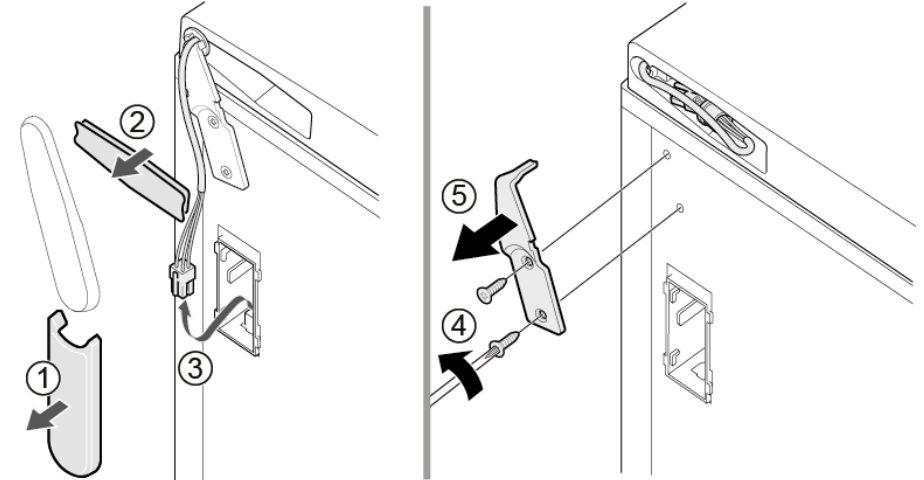

➡ Ülemine uksehing on eemaldatud.

#### 4.5.2 Uksehingepaigaldamine

- ▶ Paigaldage vastupidises järjekorras.

## 4.6 Alumise uksehinge vahetamine

### Eritööriistad:

Tähtotsik TX20

6,3 mm (1/4 tolli)

[00340865]

	<p style="text-align: center;"><b>⚠ HOIATUS</b></p> <p><b>Masked, kogukad seadmed!</b> Selja- ja lihasevigastused</p> <ul style="list-style-type: none"> <li>▶ Seadme ust tohivad eemaldada vaid vastava väljaõppe saanud spetsialistid.</li> <li>▶ Seadme liigutamiseks on vaja kaht inimest.</li> <li>▶ Kasutage vaid sobivaid tööriistu ja varustust.</li> </ul>
	<p style="text-align: center;"><b>⚠ ETTEVAATUST!</b></p> <p><b>Teravad servad!</b> Lõikehaavad</p> <ul style="list-style-type: none"> <li>▶ Kandke kaitsekindaid.</li> </ul>
	<p style="text-align: center;"><b>⚠ HOIATUS</b></p> <p><b>Viltuses asendis seadmete libisemisoht!</b> Luumurrud/muljumised</p> <ul style="list-style-type: none"> <li>▶ Kindlustage seadmed libisemise vastu.</li> </ul>
	<p style="text-align: center;"><b>⚠ ETTEVAATUST!</b></p> <p><b>Lahtikeeratud poltidest tingitud osade kukkumisoht!</b> Kukkuvatest osadest tingitud vigastused.</p> <ul style="list-style-type: none"> <li>▶ Kinnitage osa allakukkumise vastu.</li> </ul>
	<p style="text-align: center;"><b>TÄHELEPANU!</b></p> <p><b>Lahtikeeratud poltidest tingitud osade kukkumisoht!</b> Seadme teiste osade kahjustused või klientide vara kahjustused.</p> <ul style="list-style-type: none"> <li>▶ Kinnitage osa allakukkumise vastu.</li> </ul>

### Nõue:

- ✔ Seade on toitest lahutatud.
- ✔ Seadme sisearmatuur on eemaldatud.
- ✔ Seade on pandud tagaküljele.
- ✔ Ülemine hing on eemaldatud. → 151

### 4.6.1 Alumise uksehinge vahetamine

1. Eemaldage uks.

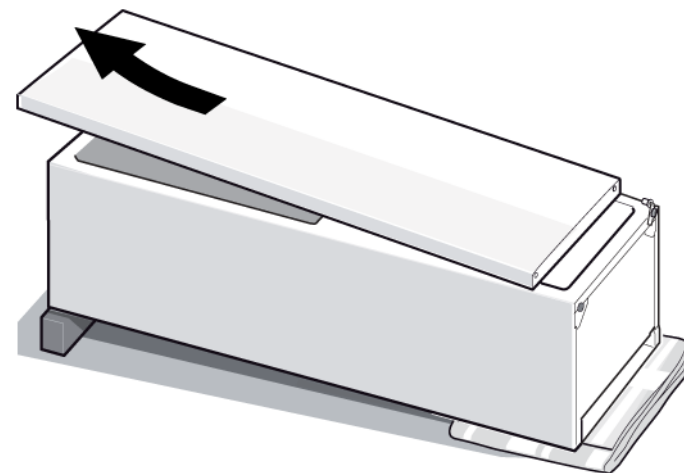

2.
  1. Keerake kruvi lahti (1).
  2. Keerake alumine hing välja (2).
  3. Eemaldage alumine hing (3).

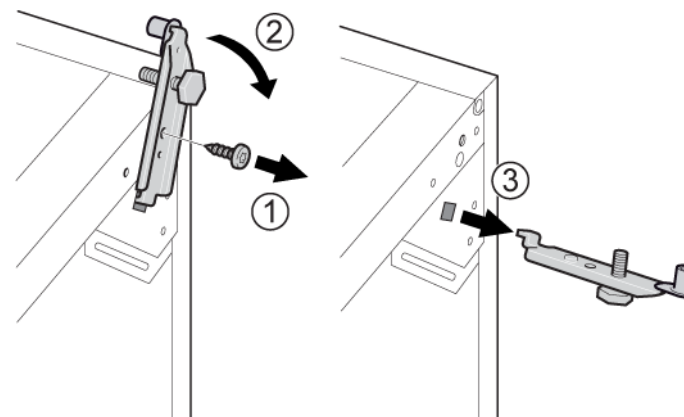

➡ Alumine hing on eemaldatud.

### 4.6.2 Alumise uksehinge paigaldamine

- ▶ Paigaldage vastupidises järjekorras.

## 4.7 Riiuli vahetamine

Nõue:

- ✔ Uks on lahti.

### 4.7.1 Riiuli eemaldamine

- ▶ Tõmmake riiul välja.

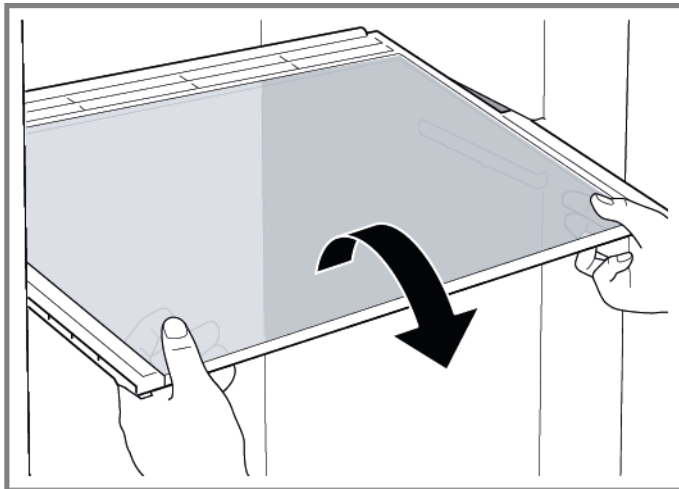

➡ Riiul on eemaldatud.

### 4.7.2 Riiuli paigaldamine

- ▶ Paigaldage vastupidises järjekorras.

## 4.8 Külmutatud toidu mahuti vahetamine

Nõue:

- ✓ Uks on lahti.

### 4.8.1 Külmutatud toidu mahuti eemaldamine

- ▶ 1. Tõmmake külmutatud toidu mahuti täielikult välja (1).
- ▶ 2. Eemaldage külmutatud toidu mahuti (2).

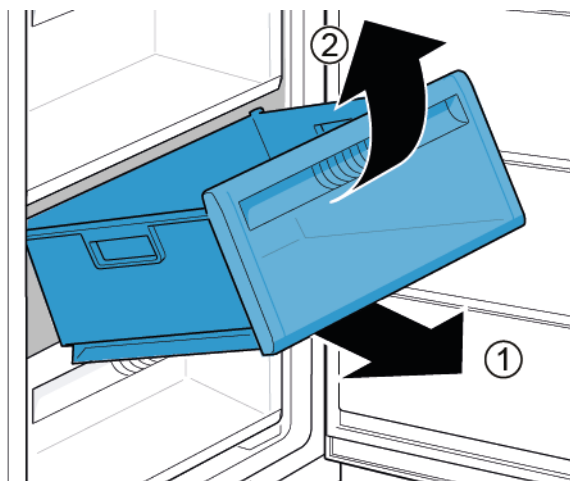

- ➡ Külmutatud toidu mahuti on eemaldatud.

### 4.8.2 Külmutatud toidu mahuti paigaldamine

- ▶ Paigaldage vastupidises järjekorras.

## 4.9 Jääkuubikute resti vahetamine

Nõue:

- ✓ Uks on lahti.

### 4.9.1 Jääkuubikute resti eemaldamine

- ▶ 1. Tõmmake välja riiul külmutatud toidu mahuti ja jääkuubikute restiga (1).
- ▶ 2. Vabastage haagid (2).
- ▶ 3. Eemaldage jääkuubikute rest (3).

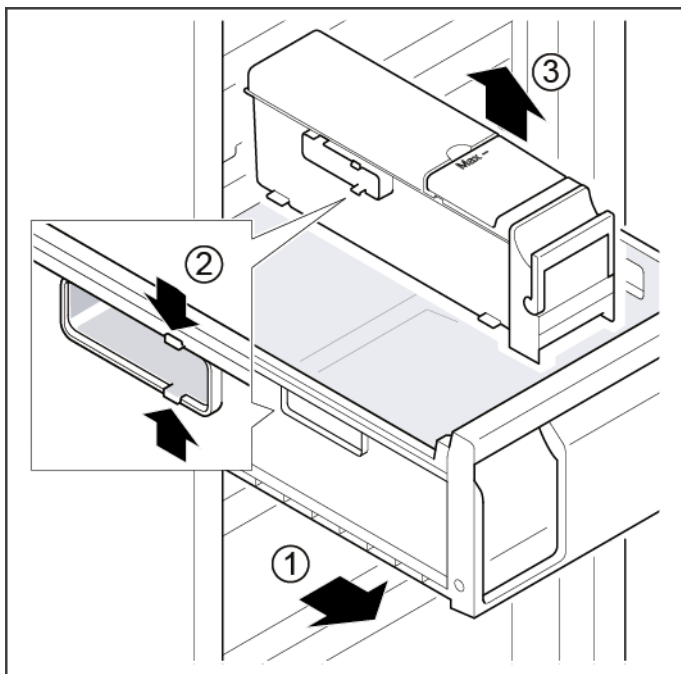

➡ Jääkuubikute rest on eemaldatud.

### 4.9.2 Jääkuubikute resti paigaldamine

- ▶ Paigaldage vastupidises järjekorras.

## 4.10 Ülemise LED-tule vahetamine

### Eritööriistad:

- Lapik kruvikeeraja Tera 2,4 mm × 0,4 mm × 60 mm, komplektis [00341820]

**i** Teie seadmel on LED-tuli, mis ei vaja hooldust. Seda tuld tohib parandada ainult klienditeenindus või volitatud tehnik!

**!** **OHT**  
**Liikuvatest osadest tingitud elektrilöögi oht!**  
Kui remonditööd on valesti tehtud, esineb elektrilöögist tingitud eluoht.  
▶ Elektrilisi osad peavad parandama kvalifitseeritud elektrikud.  
▶ Pärast remonti peab olema tehtud ohutuskatse vastavalt standardile VDE 0701 või riiklikele määrustele.

**!** **OHT**  
**Liikuvatest osadest tingitud elektrilöögi oht!**  
Elektrilöögist tingitud surm  
▶ Enne remonditöödega alustamist ühendage seadmed elektrivõrgust lahti vähemalt 60 sekundit varem.

**!** **ETTEVAATUST!**  
**Teravad servad!**  
Löikehaavad  
▶ Kandke kaitsekindaid.

### Nõue:

- ✓ Seade on toitest lahutatud.
- ✓ Uks on lahti.
- ✓ Ülemine sisearmatuur on eemaldatud.

### 4.10.1 LED-tule eemaldamine

1. Liigutage LED-tuld vasakule.



- ➡ LED-tule elektriühendus on lahutatud.

2. Vabastage LED-tule haagid.

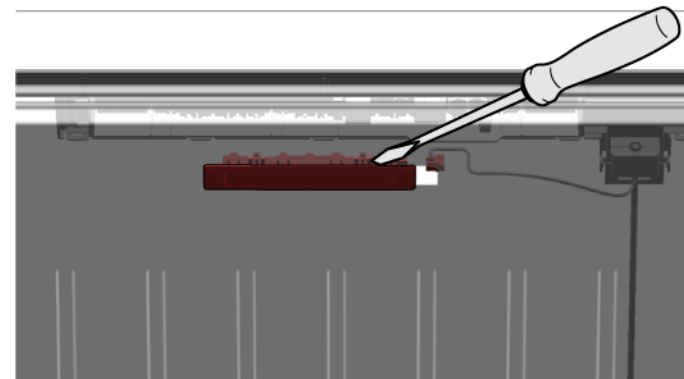

3. Eemaldage LED-tuli, liigutades seda ettepoole.

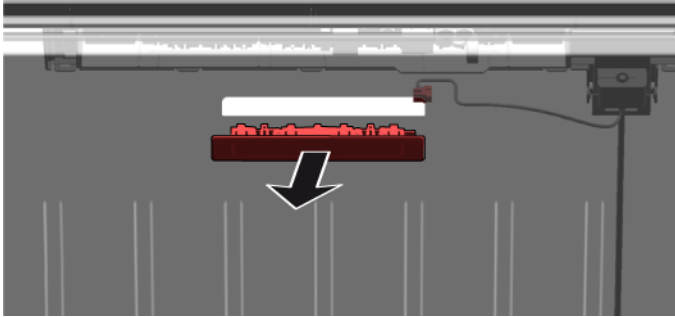





- ➔ LED-tuli on eemaldatud.

## 4.10.2 Ülemise LED-tule paigaldamine

- ▶ Paigaldage vastupidises järjekorras.

# Korjausvinkit - Pakastin

 <b>Tämä asiakirja</b> .....	<b>161</b>
1.1 Tärkeitä tietoja.....	161
1.1.1 Tarkoitus .....	161
1.2 Symboleiden merkitys.....	161
1.2.1 Vaaratasot.....	161
1.2.2 Varoitusmerkit.....	161
1.2.3 Varoitusten rakenne .....	162
1.2.4 Yleiset symbolit.....	162
 <b>Turvallisuus</b> .....	<b>163</b>
2.1 Yleiset turvallisuusohjeet.....	163
2.1.1 Kaikki kotitalouskoneet.....	163
 <b>Työkalut ja apuvälineet</b> .....	<b>164</b>
 <b>Korjaus</b> .....	<b>165</b>
4.1 Oven tiivisteen vaihtaminen.....	165
4.1.1 Oven tiivisteen poistaminen .....	165
4.1.2 Oven tiivisteen asennus .....	165
4.2 Ovenkahvan vaihtaminen.....	168
4.2.1 Ovenkahvan poistaminen .....	168
4.2.2 Ovenkahvan asennus.....	168
4.3 Easy opening handle -kahvan vaihtaminen .....	169
4.3.1 Easy opening handle -kahvan avautuvan ovenkahvan poistaminen ...	169
4.3.2 Easy opening handle -kahvan asennus .....	169
4.4 Oven yläsaranan vaihtaminen .....	170
4.4.1 Oven saranan poistaminen .....	170
4.4.2 Oven saranan asennus .....	172
4.5 Oven yläsaranan vaihtaminen (näytöllä varustettu ovi).....	173
4.5.1 Oven saranan poistaminen .....	174
4.5.2 Oven saranan asennus .....	175
4.6 Oven alasaranan vaihtaminen .....	176
4.6.1 Oven alasaranan vaihtaminen.....	176
4.6.2 Oven alasaranan asennus.....	176
4.7 Hyllyn vaihtaminen .....	177
4.7.1 Hyllyn poistaminen .....	177
4.7.2 Hyllyn asennus .....	177

4.8 Pakastelokeron vaihtaminen .....	178
4.8.1 Pakastelokeron poistaminen .....	178
4.8.2 Pakastelokeron asennus.....	178
4.9 Jääpala-automaatin vaihtaminen.....	179
4.9.1 Jääpala-automaatin poistaminen .....	179
4.9.2 Jääpala-automaatin asennus .....	179
4.10 LED-ylävalon vaihtaminen .....	180
4.10.1 LED-valon poistaminen .....	180
4.10.2 LED-ylävalon asennus .....	181



# Tämä asiakirja

## 1.1 Tärkeitä tietoja

### 1.1.1 Tarkoitus

Näiden korjausohjeiden tarkoituksena on auttaa kuluttajaa korjaamaan laitteita itse ekologista suunnittelua koskevan asetuksen (päivitys 03/2021) mukaisesti.



Ne sisältävät tietoja siitä, miten määrätyt varaosat voidaan vaihtaa. Lisäksi niihin sisältyy tietoja varoituksista ja riskeistä.

Ota yhteyttä huoltopalveluun, jos sinulla on kysyttävää. Vastamme vahingoista vain, jos korjausohjeita on noudatettu oikein.

## 1.2 Symboleiden merkitys

### 1.2.1 Vaaratasot

Varoitustasot koostuvat symbolista ja huomiosanasta. Huomiosanat ilmoittava vaaran vakavuuden.

Varoitustaso	Merkitys
 <b>VAARA</b>	Varoituksen laiminlyönti johtaa kuolemaan tai vakaviin loukkaantumisiin.
 <b>VAROITUS</b>	Varoituksen laiminlyönti voi johtaa kuolemaan tai vakaviin loukkaantumisiin.
 <b>HUOMAA</b>	Varoituksen laiminlyönti voi johtaa lieviin loukkaantumisiin.
<b>HUOMIO!</b>	Varoituksen laiminlyönti voi johtaa omaisuusvahinkoihin.

Taulukko 1: Vaaratasot

### 1.2.2 Varoitusmerkit

Varoitusmerkit ovat symboleita sisältäviä esityksiä, jotka osoittavat vaaran tyyppin.

Tässä asiakirjassa käytetään seuraavia varoitusmerkkejä:

Varoitusmerkki	Merkitys
	Yleinen varoitus
	Sähköjännitteestä aiheutuva vaara
	Räjähdysvaara
	Viiltohaavojen vaara
	Murskautumisen vaara

# Tämä asiakirja

Varoitusmerkki	Merkitys
	Kuumista pinnoista aiheutuva vaara
	Voimakkaasta magneettikentästä aiheutuva vaara
	Ionisoimattomasta säteilystä aiheutuva vaara



Taulukko 2: Varoitusmerkit

## 1.2.3 Varoitusten rakenne

Tämän asiakirjan sisältämällä varoituksilla on standardoitu ulkonäkö ja rakenne.



	<div style="background-color: red; color: white; padding: 2px; text-align: center;"> <b>VAARA</b></div> <p><b>Vaaran tyyppi ja lähde!</b> Vaaran/varoituksen laiminlyönnistä mahdollisesti aiheutuvat seuraukset.</p> <ul style="list-style-type: none"><li>▶ Vaaran ehkäisemiseen liittyvät toimenpiteet ja kiellot.</li></ul>
--	--

Seuraavassa esimerkissä näytetään varoitus, joka varoittaa jännitteisten osien aiheuttamasta sähköiskusta. Vaaran välttämiseksi suoritettava toimenpide mainitaan.

	<div style="background-color: red; color: white; padding: 2px; text-align: center;"> <b>VAARA</b></div> <p><b>Jännitteisten osien aiheuttama sähköiskun vaara!</b> Sähköiskun aiheuttama kuolema</p> <ul style="list-style-type: none"><li>▶ Erotta laitteet sähkövirrasta vähintään 60 sekuntia ennen korjaustöiden aloittamista.</li></ul>
---	---

## 1.2.4 Yleiset symbolit

Tässä asiakirjassa käytetään seuraavia yleisiä symboleja:

Yl. symboli	Merkitys
	Erikoisohjeen tunniste (teksti ja/tai kaavio)
	Yksinkertaisen ohjeen tunniste (vain teksti)

Yl. symboli	Merkitys
	Video-opetusohjelmaan johtavan linkin tunniste
	Tarvittavien työkalujen tunniste
	Tarvittavien edellytysten tunniste
	Ehdon (jos ..., sitten ...) tunniste
	Tuloksen tunniste
	Näppäimen tai painikkeen tunniste
	Materiaalinumeron tunniste
	Näytetyn tekstin/ikkunan (laitteen näytössä) tunniste

Taulukko 3: Yleiset symbolit

## 2.1 Yleiset turvallisuusohjeet

### 2.1.1 Kaikki kotitalouskoneet

#### Jännitteisten osien aiheuttama sähköiskun vaara!

- Virheet sähkökomponentteja sisältävissä korjauksissa voivat johtaa sähköiskuun!
- Kytke kone irti verkkovirrasta vähintään 60 sekuntia ennen töiden aloittamista.
- Pyydä korjauksen jälkeen suorittamaan VDE 0701 -säädöksen tai maakohtaisten säädösten mukainen turvallisuustesti.

#### Terävistä reunoista aiheutuva loukkaantumisvaara!

- Käytä suojakäsineitä.

#### Painavista ja liikkuvista komponenteista aiheutuva murskautumisen riski korjauksen, kunnossapidon, vianetsinnän ja huollon aikana

- Käytä suojakenkiä.
- Estä painavien komponenttien putoaminen.
- Älä koske liikkuviin komponentteihin.



#### Laitteen turvallisuudelle/toiminnalle aiheutuva riski!

- Käytä vain alkuperäisiä varaosia.

#### Staattiselle sähkölle herkkien komponenttien (ESDS) vaurioitumisen riski!

- Älä koske moduuleihin, liitännät ja johdinreitit mukaan luettuna.

## Työkalut ja apuvälineet

Nimitys	Yksityiskohdat	Kuvat
Suojapeite [00342013]	60 cm x 50 cm	
Phillips-ruuvimeisseli PH2		
Torx-kärki TX20 [00340865]	6,3 mm (1/4")	
Uraruuvimeisseli	Terä 2,4 mm x 0,4 mm x 60 mm, pakkauksessa [00341820]	

## 4.1 Oven tiiviste vaihtaminen

### Vaatus:

- ✓ Ovi on auki.

### 4.1.1 Oven tiiviste poistaminen

1. Irrota oven tiiviste urasta oikeassa ja vasemmassa nurkassa.

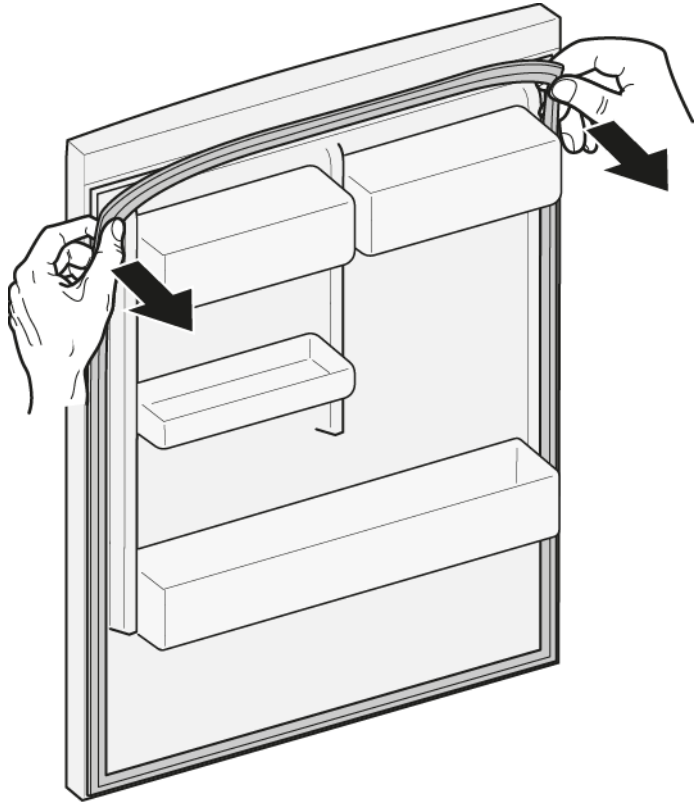

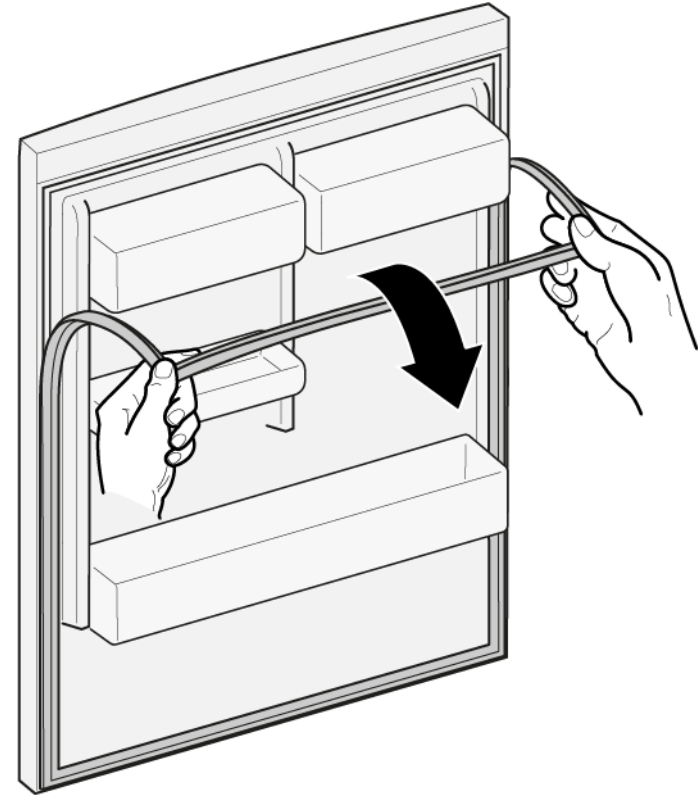

2. Vedä oven tiiviste ulos urasta.





- ➡ Oven tiiviste on poistettu.

### 4.1.2 Oven tiiviste asennus

	Uuden tiiviste paksuus voi poiketa hieman vanhan tiiviste paksuudesta. Sillä ei ole vaikutusta oven sulkeutumiseen eikä pitkän aikavälin toimintaan.
	Jos laitteessa on säädettävät saranat tai saranan kiinnittimet, voit optimoida sulkeutumista myöhemmin.
	Oven tiiviste sivuilla olevat pienet reiät ovat toiminnollisia (tarvitaan ilmanvaihtoa varten). Ne eivät ole tuotantovirheitä.

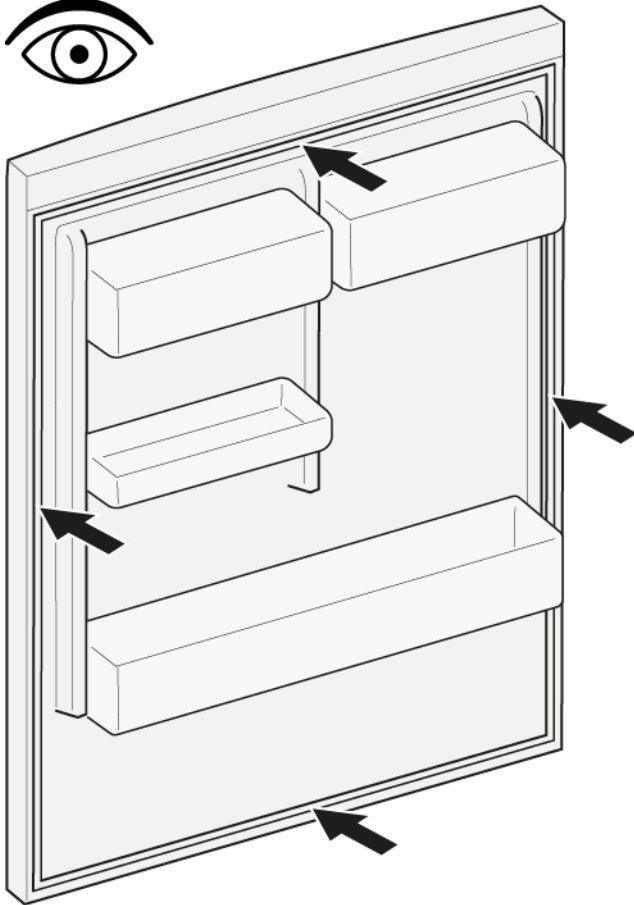
1. Tarkista, että tiivistettä varten oleva ura ei ole vioittunut.



2.  Jos tiivisteen ura on vioittunut.  
- Ota yhteyttä asiakaspalveluun.

3.  Oven tiivisteen pienet vääntymät ovat normaaleja eikä niillä ole vaikutusta sen toimintaan. Oven tiiviste kannattaa suoristaa, ennen kuin se asetetaan laitteeseen.

Kuumenna oven tiivistettä hiustenkuivaajalle tai kuumalla vedellä ja muotoile se käsin uudelleen.

4. Työnnä tiivisteen nurkat ylhäällä ja alhaalla uraan.

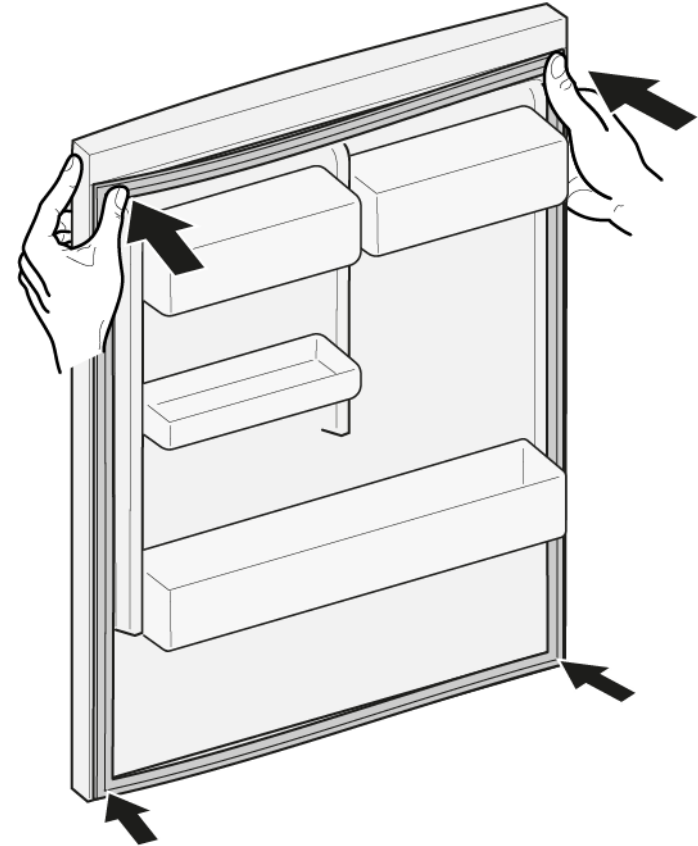

5. Paina koko tiiviste vähitellen uraan.

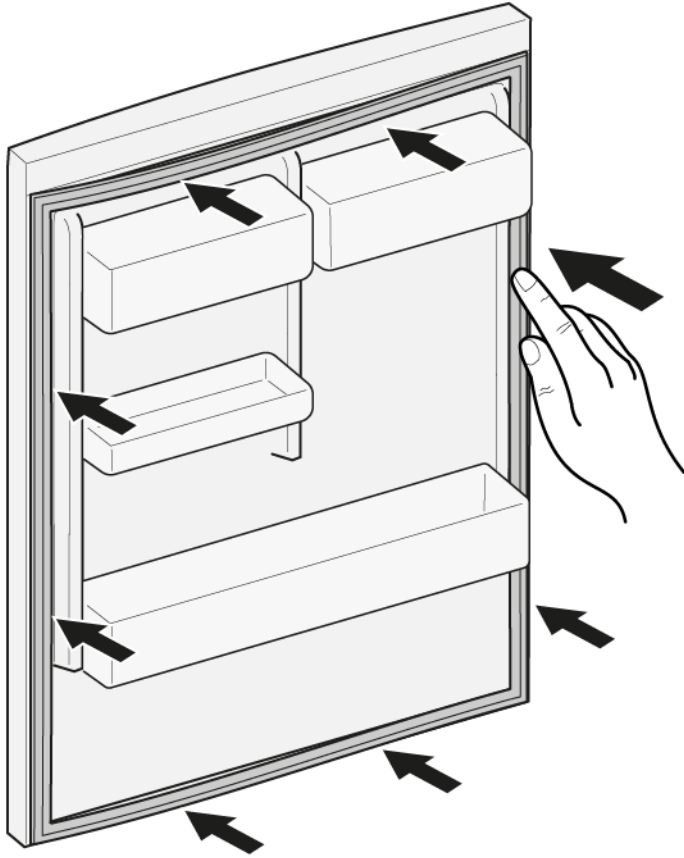

➡ Oven tiiviste on asennettu.

## 4.2 Ovenkahvan vaihtaminen

### Erikoistyökalut:

- Torx-kärki TX20 6,3 mm (1/4") [00340865]
- Uruuvimeisseli Terä 10 mm x 1,6 mm x 200 mm

### Vaatimus:

- ✓ Kone on erotettu teholahteesta.
- ✓ Ovi on auki.

### 4.2.1 Ovenkahvan poistaminen

- 1. Poista kaksi ruuvia suojusta (1).
- 2. Kierrä kaksi ruuvia auki (2).
- 3. Poista ovenkahva (3).

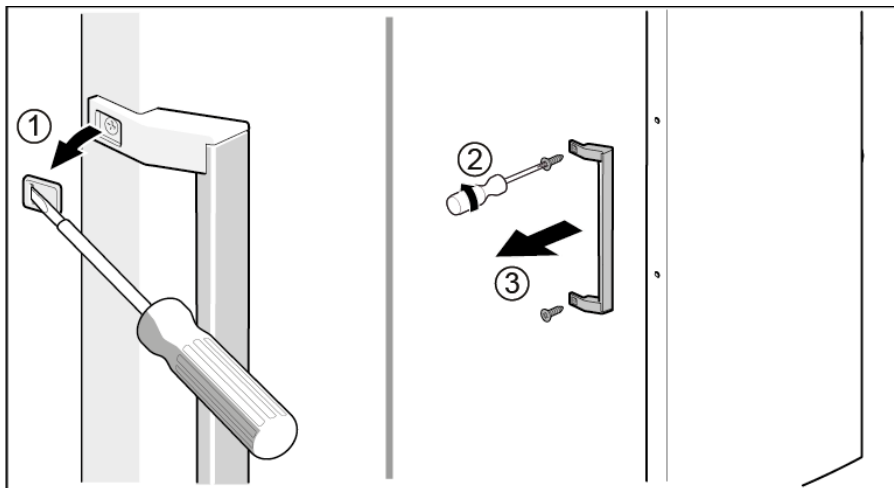

➡ Ovenkahva on poistettu.

### 4.2.2 Ovenkahvan asennus

- Asenna vastakkaisessa järjestyksessä.



## 4.3 Easy opening handle -kahvan vaihtaminen

### Erikoistyökalut:

- Phillips-ruuvimeisseli PH2

### Vaatus:

- ✓ Kone on erotettu tehollanteesta.
- ✓ Ovi on auki.

### 4.3.1 Easy opening handle -kahvan avautuvan ovenkahvan poistaminen

- Poista Easy opening handle -kahvan suojuksen (1).
- Kierrä kaksi ruuvia auki (2).

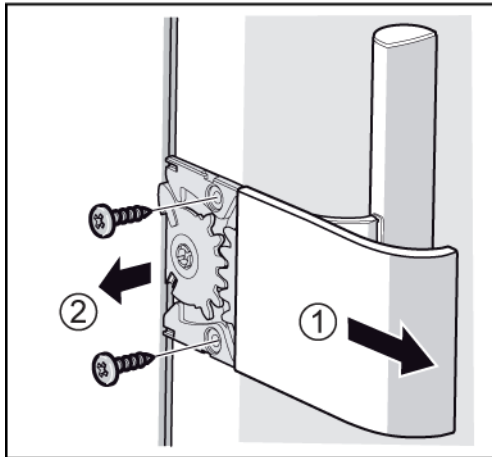

- Easy opening handle -kahva on poistettu.

### 4.3.2 Easy opening handle -kahvan asennus

Easy opening handle -kahvan mekanismi tulisi säätää oikein ennen kahvan asentamista. Kuvassa näkyy oven vasemman puolen asennuksen työntötangon (1), hammastettujen neljännesympyröiden (2) ja (3), jousen (4) ja rajoittimen (5) oikea järjestys.

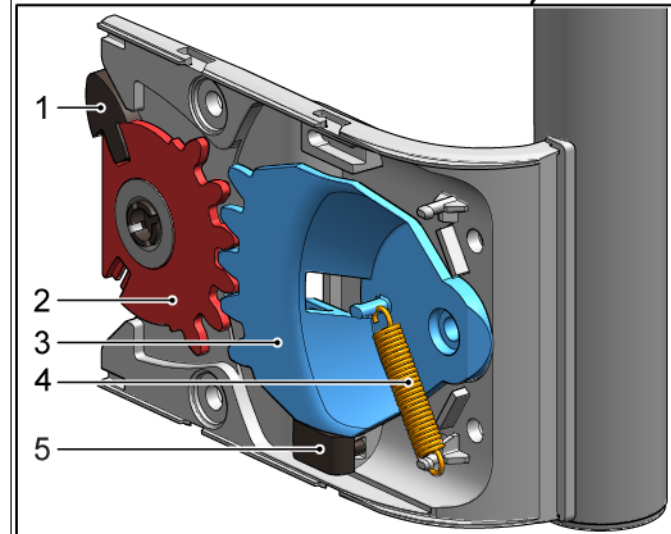

Oven oikean puolen Easy opening handle -kahvan asennuksen osien järjestys on kuvailtu asiakirjassa "Asennusohjeet".

- Asenna vastakkaisessa järjestyksessä.





## 4.4 Oven yläsaranan vaihtaminen

### Erikoistyökalut:



 Torx-kärki TX20

6,3 mm (1/4")

[00340865]

	<b>VAROITUS</b> <b>Painavat, isokokoiset laitteet!</b> Selän ja lihasten vammat <ul style="list-style-type: none"><li>▶ Vain koulutettujen ammattilaisten tulisi suorittaa laitteen oven poistamiseen liittyvät vaiheet.</li><li>▶ Laitteen siirtämiseen tarvitaan kahta ihmistä.</li><li>▶ Käytä vain soveltuvia työkaluja ja välineitä.</li></ul>
	<b>HUOMAA</b> <b>Terävät reunat!</b> Viiltovammat <ul style="list-style-type: none"><li>▶ Käytä suojakäsineitä.</li></ul>
	<b>VAROITUS</b> <b>Kallistetun koneen luiskahtaminen.!</b> Luunmurtumat/murskavammat <ul style="list-style-type: none"><li>▶ Estä koneiden luiskahtaminen.</li></ul>
	<b>HUOMAA</b> <b>Ruuvien avaamisesta aiheutuva osien putoamisen riski!</b> Loukkaantuminen putoavien osien vuoksi. <ul style="list-style-type: none"><li>▶ Estä komponentin putoaminen.</li></ul>
	<b>HUOMIO!</b> <b>Ruuvien avaamisesta aiheutuva osien putoamisen riski!</b> Vauriot koneen muille osille tai asiakkaan kodille, esim. lattia. <ul style="list-style-type: none"><li>▶ Estä komponentin putoaminen.</li></ul>

### Vaatus:

-  Kone on erotettu teholähteestä.
-  Laitteen sisällä olevat lisävarusteet on poistettu.

## 4.4.1 Oven saranan poistaminen

1. Aseta laite selälleen.

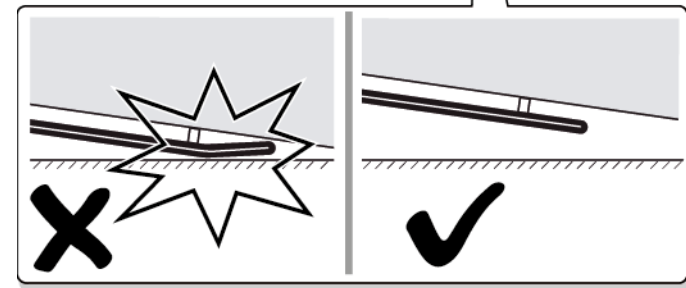
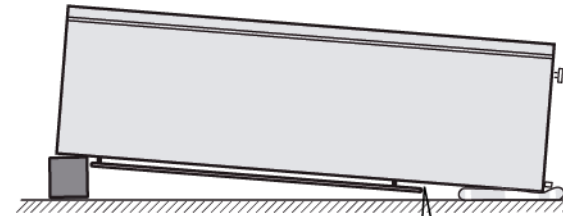
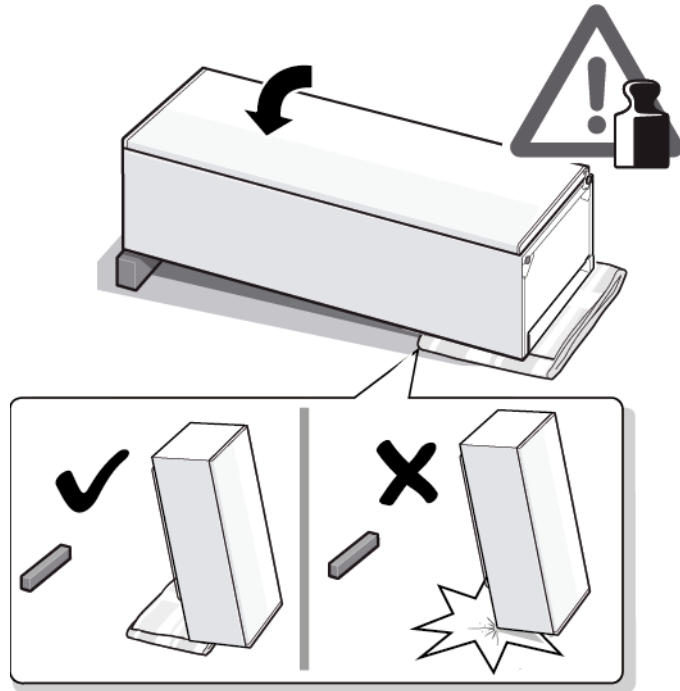

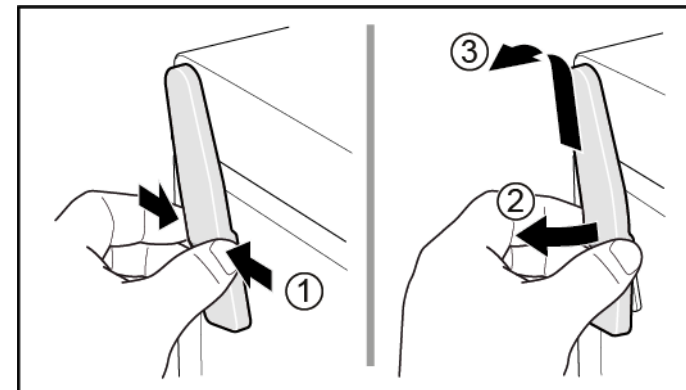

1. Paina yläsaranan suojusta kummallakin puolella (1).
2. Ota yläsaranan suojus ulos (2).
3. Poista yläsaranan suojus (3).

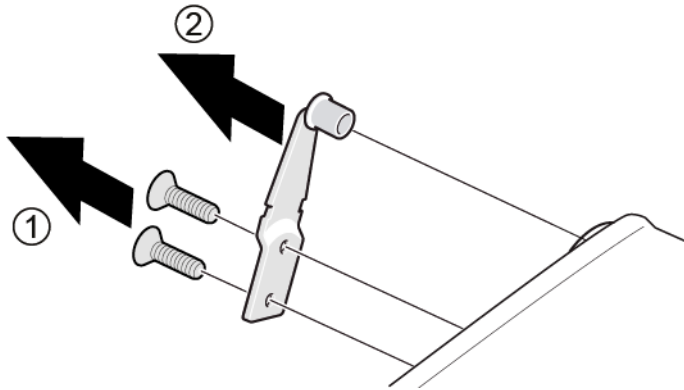

## Korjaus

3. 1. Kierrä kaksi ruuvia auki (1).
2. Poista yläsarana (2).



 Oven yläsarana on poistettu.



### 4.4.2 Oven saranan asennus



- ▶ Asenna vastakkaisessa järjestyksessä.

## 4.5 Oven yläsaranan vaihtaminen (näytöllä varustettu ovi)



### Erikoistyökalut:

 Torx-kärki TX20                      6,3 mm (1/4")                      [00340865]

	 <b>VAROITUS</b>
	<p><b>Painavat, isokokoiset laitteet!</b> Selän ja lihasten vammat</p> <ul style="list-style-type: none"> <li>▶ Vain koulutettujen ammattilaisten tulisi suorittaa laitteen oven poistamiseen liittyvät vaiheet.</li> <li>▶ Laitteen siirtämiseen tarvitaan kahta ihmistä.</li> <li>▶ Käytä vain soveltuvia työkaluja ja välineitä.</li> </ul>



	 <b>HUOMAA</b>
	<p><b>Terävät reunat!</b> Viiltovammat</p> <ul style="list-style-type: none"> <li>▶ Käytä suojakäsineitä.</li> </ul>

	 <b>VAROITUS</b>
	<p><b>Kallistetun koneen luiskahtaminen.!</b> Luunmurtumat/murskavammat</p> <ul style="list-style-type: none"> <li>▶ Estä koneiden luiskahtaminen.</li> </ul>



	 <b>HUOMAA</b>
	<p><b>Ruuvien avaamisesta aiheutuva osien putoamisen riski!</b> Loukkaantuminen putoavien osien vuoksi.</p> <ul style="list-style-type: none"> <li>▶ Estä komponentin putoaminen.</li> </ul>

	<b>HUOMIO!</b>
	<p><b>Ruuvien avaamisesta aiheutuva osien putoamisen riski!</b> Vauriot koneen muille osille tai asiakkaan kodille, esim. lattia.</p> <ul style="list-style-type: none"> <li>▶ Estä komponentin putoaminen.</li> </ul>

	 <b>VAARA</b>
	<p><b>Jännitteisten osien aiheuttama sähköiskun vaara!</b> Sähköiskusta aiheutuva hengenvaara väärän korjauksen tapauksessa</p> <ul style="list-style-type: none"> <li>▶ Sähköosien korjaus tulisi antaa pätevien sähköasentajien suoritettavaksi.</li> <li>▶ Pyydä korjauksen jälkeen suorittamaan VDE 0701 -säädöksen tai maakohtaisten säädösten mukainen turvallisuustesti.</li> </ul>

	 <b>VAARA</b>
	<p><b>Jännitteisten osien aiheuttama sähköiskun vaara!</b> Sähköiskun aiheuttama kuolema</p> <ul style="list-style-type: none"> <li>▶ Erotta laitteet sähkövirrasta vähintään 60 sekuntia ennen korjaustöiden aloittamista.</li> </ul>

**Vaatus:**

-  Kone on erotettu tehollanteesta.
-  Laitteen sisällä olevat lisävarusteet on poistettu.

## 4.5.1 Oven saranan poistaminen

1. Aseta laite selälleen.

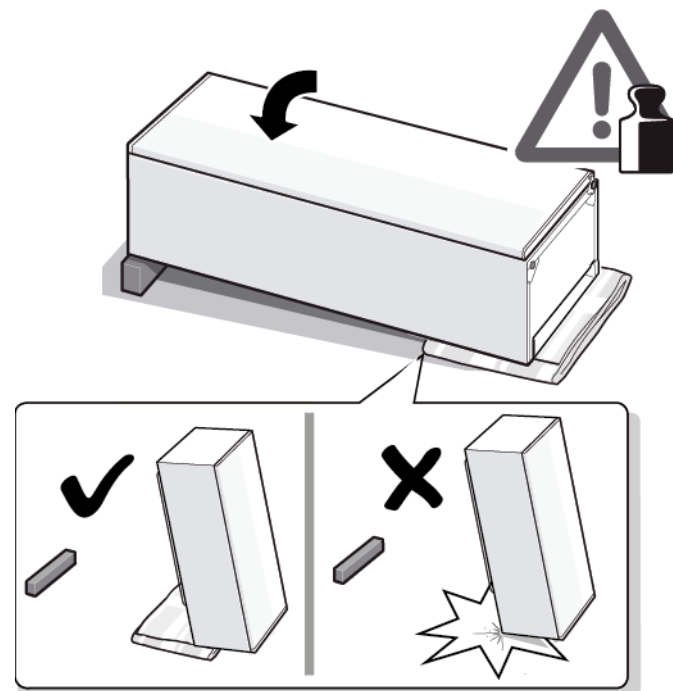

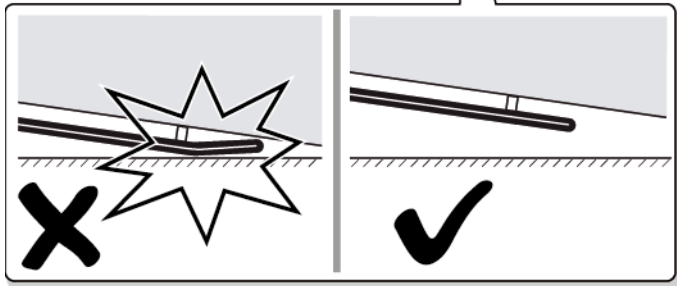
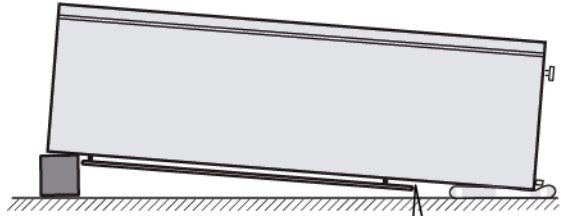

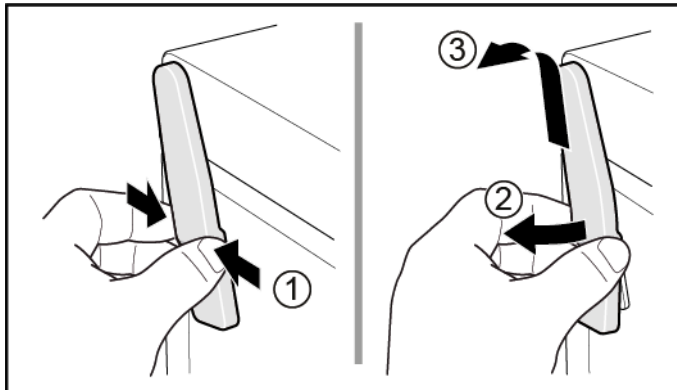

2. 1. Paina yläsaranan suojusta kummallakin puolella (1).
2. Ota yläsaranan suojuus ulos (2).
3. Poista yläsaranan suojuus (3).

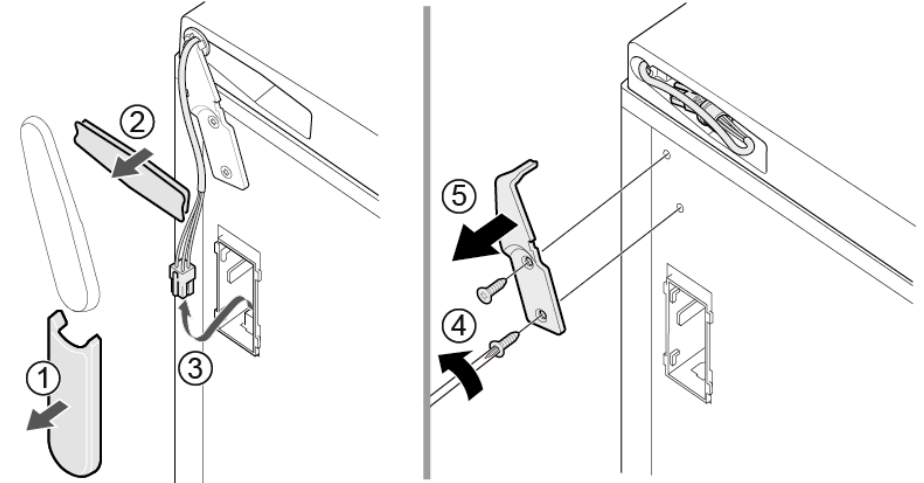

3. 1. Poista kaapelirasian suojuus (1).
2. Poista kaapelisuojaus (2).
3. Irrota sähköliitäntä (3).
4. Kierrä kaksi ruuvia auki (4).
5. Poista yläsarana (5).



 Oven yläsarana on poistettu.

#### 4.5.2 Oven saranan asennus

- ▶ Asenna vastakkaisessa järjestyksessä.





## 4.6 Oven alasaranan vaihtaminen

### Erikoistyökalut:

Torx-kärki TX20

6,3 mm (1/4")

[00340865]

	<p style="text-align: center;"><b>VAROITUS</b></p> <p><b>Painavat, isokokoiset laitteet!</b> Selän ja lihasten vammat</p> <ul style="list-style-type: none"> <li>▶ Vain koulutettujen ammattilaisten tulisi suorittaa laitteen oven poistamiseen liittyvät vaiheet.</li> <li>▶ Laitteen siirtämiseen tarvitaan kahta ihmistä.</li> <li>▶ Käytä vain soveltuvia työkaluja ja välineitä.</li> </ul>
	<p style="text-align: center;"><b>HUOMAA</b></p> <p><b>Terävät reunat!</b> Viiltovammat</p> <ul style="list-style-type: none"> <li>▶ Käytä suojakäsineitä.</li> </ul>
	<p style="text-align: center;"><b>VAROITUS</b></p> <p><b>Kallistetun koneen luiskahtaminen.!</b> Luunmurtumat/murskavammat</p> <ul style="list-style-type: none"> <li>▶ Estä koneiden luiskahtaminen.</li> </ul>
	<p style="text-align: center;"><b>HUOMAA</b></p> <p><b>Ruuvien avaamisesta aiheutuva osien putoamisen riski!</b> Loukkaantuminen putoavien osien vuoksi.</p> <ul style="list-style-type: none"> <li>▶ Estä komponentin putoaminen.</li> </ul>
	<p style="text-align: center;"><b>HUOMIO!</b></p> <p><b>Ruuvien avaamisesta aiheutuva osien putoamisen riski!</b> Vauriot koneen muille osille tai asiakkaan kodille, esim. lattia.</p> <ul style="list-style-type: none"> <li>▶ Estä komponentin putoaminen.</li> </ul>

### Vaatus:

- ✓ Kone on erotettu teholähteestä.
- ✓ Laitteen sisällä olevat lisävarusteet on poistettu.
- ✓ Laite on asetettu selälleen.
- ✓ [Yläsarana on poistettu. → 173](#)

### 4.6.1 Oven alasaranan vaihtaminen

1. Poista ovi.

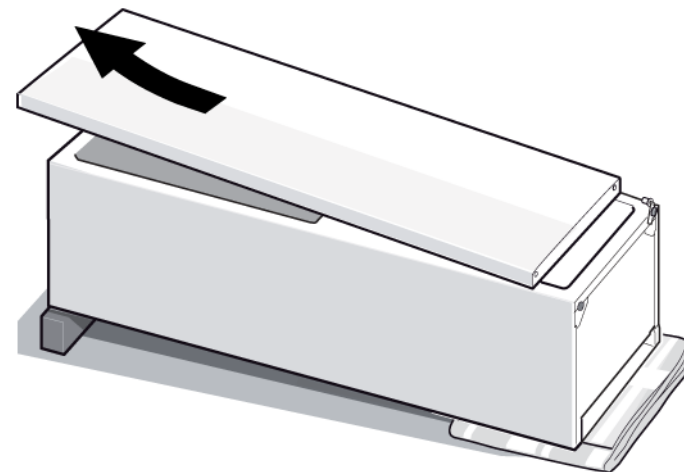

2. 1. Kierrä ruuvi auki (1).
2. Kierrä alasarana ulos (2).
3. Poista alasarana (3).

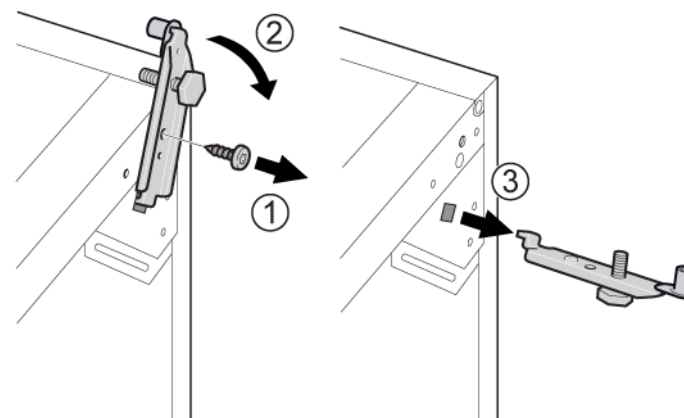

➡ Alasarana on poistettu.

### 4.6.2 Oven alasaranan asennus

- ▶ Asenna vastakkaisessa järjestyksessä.



## 4.7 Hyllyn vaihtaminen

### Vaatus:

- ✔ Ovi on auki.

### 4.7.1 Hyllyn poistaminen

- ▶ Vedä hylly ulos.



- ➡ Hylly on poistettu.

### 4.7.2 Hyllyn asennus

- ▶ Asenna vastakkaisessa järjestyksessä.

## 4.8 Pakastelokeron vaihtaminen

### Vaatus:

- ✔ Ovi on auki.

### 4.8.1 Pakastelokeron poistaminen

- ▶ 1. Vedä pakastelokero kokonaan ulos (1).
- ▶ 2. Poista pakastelokero (2).

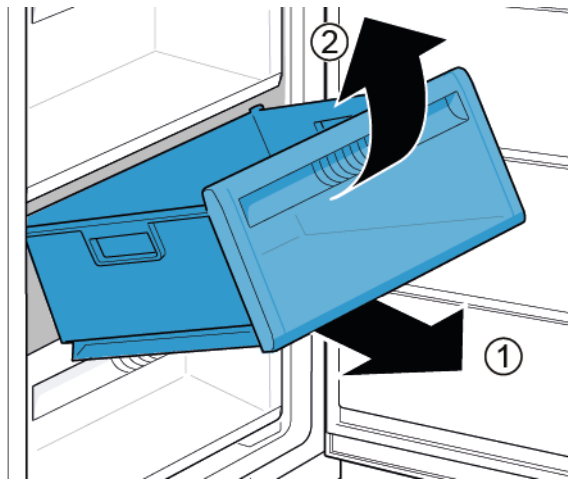

- ➡ Pakastelokero on poistettu.

### 4.8.2 Pakastelokeron asennus

- ▶ Asenna vastakkaisessa järjestyksessä.

## 4.9 Jääpala-automaatin vaihtaminen

### Vaatus:

- ✔ Ovi on auki.

### 4.9.1 Jääpala-automaatin poistaminen

- ▶ 1. Vedä ulos pakastelokero jääpala-automaatin kanssa (1).
- ▶ 2. Avaa lukitukset (2).
- ▶ 3. Poista jääpala-automaatti (3).

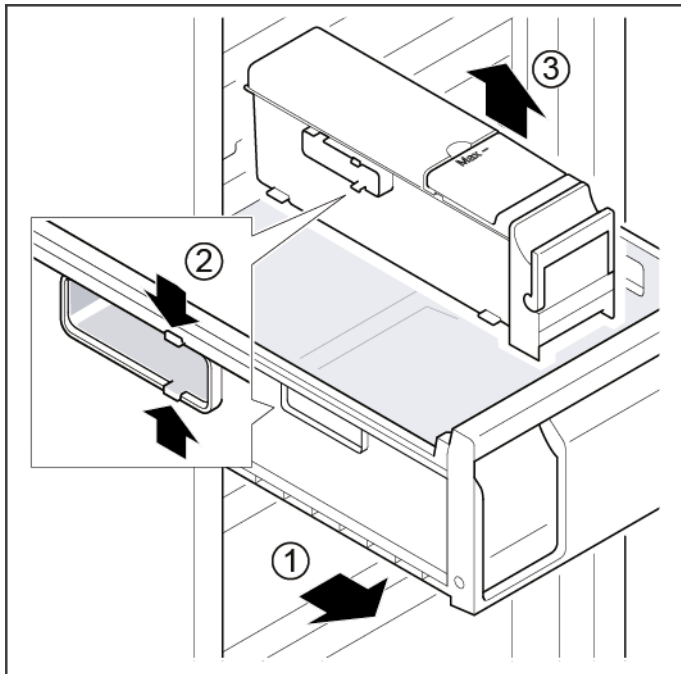

➡ Jääpala-automaatti on poistettu.

### 4.9.2 Jääpala-automaatin asennus

- ▶ Asenna vastakkaisessa järjestyksessä.

## 4.10 LED-ylävalon vaihtaminen

### Erikoistyökalut:

-  Uraruuvimeisseli
- Terä 2,4 mm x 0,4 mm x 60 mm, pakkauksessa [00341820]



	Laite on varustettu huoltovapaalla LED-valolla. Vain huoltopalvelu tai valtuutetut teknikot saavat korjata nämä valot!
---	--

	<b>VAARA</b>
	<p><b>Jännitteisten osien aiheuttama sähköiskun vaara!</b> Sähköiskusta aiheutuva hengenvaara väärän korjauksen tapauksessa</p> <ul style="list-style-type: none"> <li>▶ Sähköosien korjaus tulisi antaa pätevien sähköasentajien suorittavaksi.</li> <li>▶ Pyydä korjauksen jälkeen suorittamaan VDE 0701 -säädöksen tai maakontaisten säädösten mukainen turvallisuustesti.</li> </ul>

	<b>VAARA</b>
	<p><b>Jännitteisten osien aiheuttama sähköiskun vaara!</b> Sähköiskun aiheuttama kuolema</p> <ul style="list-style-type: none"> <li>▶ Erotta laitteet sähkövirrasta vähintään 60 sekuntia ennen korjaustöiden aloittamista.</li> </ul>

	<b>HUOMAA</b>
	<p><b>Terävät reunat!</b> Viiltovammat</p> <ul style="list-style-type: none"> <li>▶ Käytä suojakäsineitä.</li> </ul>

### Vaatus:

-  Kone on erotettu teholahteesta.
-  Ovi on auki.
-  Sisällä olevat ylemmät lisävarusteet on poistettu.

### 4.10.1 LED-valon poistaminen

- Siirrä LED-valo vasemmalle sivulle.

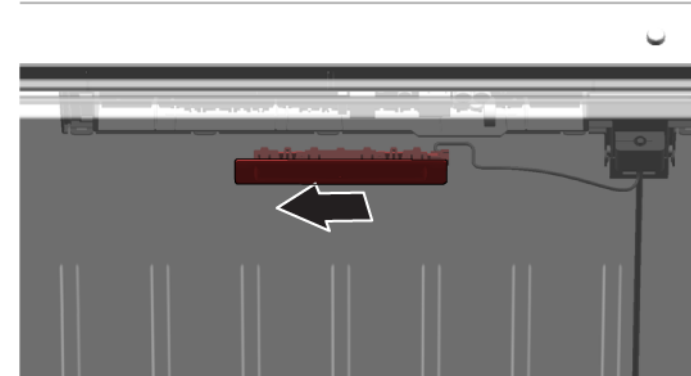

-  LED-valon sähköliitäntä on erotettu.

- Avaa LED-valon lukitukset.



3. Poista LED-valo siirtämällä sitä etusuuntaan.

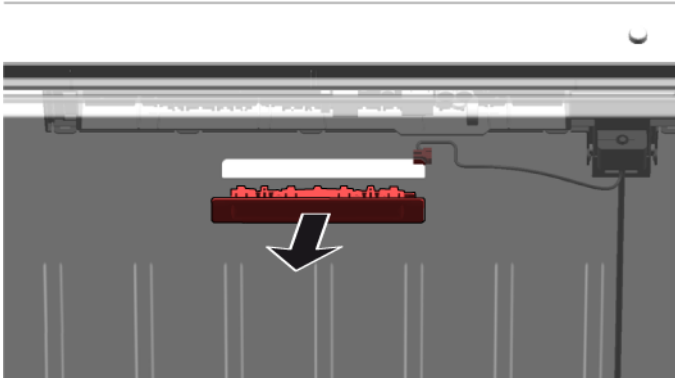

- ➔ LED-valo on poistettu.

## 4.10.2 LED-ylävalon asennus

- ▶ Asenna vastakkaisessa järjestyksessä.

# Conseils de réparation - Congélateur

## **A propos de ce document..... 183**

1.1	Informations importantes.....	183
1.1.1	Objectif.....	183
1.2	Explication des symboles.....	183
1.2.1	Niveaux de risque.....	183
1.2.2	Symboles de danger.....	183
1.2.3	Structure des indications d'avertissement.....	184
1.2.4	Symboles généraux.....	184

## **Sécurité..... 185**

2.1	Consignes de sécurité générales.....	185
2.1.1	Tous les appareils électroménagers.....	185

## **Outils et aides..... 186**

## **Réparation ..... 187**

4.1	Remplacer le joint de porte.....	187
4.1.1	Retirer le joint de porte.....	187
4.1.2	Monter le joint de porte.....	187
4.2	Remplacer la poignée de porte.....	190
4.2.1	Retirer la poignée de porte.....	190
4.2.2	Monter la poignée de porte.....	190
4.3	Echange de la poignée à ouverture facile.....	191
4.3.1	Retrait de la poignée à ouverture facile.....	191
4.3.2	Montage de la poignée à ouverture facile.....	191
4.4	Remplacer la charnière supérieure de la porte.....	192
4.4.1	Retirer la charnière de porte.....	192
4.4.2	Monter la charnière de porte.....	194
4.5	Remplacer la charnière supérieure de la porte (porte avec afficheur).....	195
4.5.1	Retirer la charnière de porte.....	196
4.5.2	Monter la charnière de porte.....	197
4.6	Remplacer la charnière de porte inférieure.....	198
4.6.1	Remplacer la charnière de porte inférieure.....	198
4.6.2	Monter la charnière de porte inférieure.....	199
4.7	Remplacer la tablette.....	200
4.7.1	Retirer la tablette.....	200
4.7.2	Monter la tablette.....	200

4.8	Remplacer le bac d'aliments congelés.....	201
4.8.1	Retirer le bac d'aliments congelés.....	201
4.8.2	Monter le bac d'aliments congelés.....	201
4.9	Remplacer la fabrique de glace.....	202
4.9.1	Retirer la fabrique de glace.....	202
4.9.2	Monter la fabrique de glace.....	202
4.10	Remplacer l'éclairage LED supérieur.....	203
4.10.1	Retirer l'éclairage LED.....	203
4.10.2	Monter l'éclairage LED supérieur.....	204

# **i** A propos de ce document

## 1.1 Informations importantes

### 1.1.1 Objectif

Les conseils de réparation qui suivent visent à permettre au consommateur de réparer l'appareil par lui-même, conformément au règlement sur l'écoconception (en vigueur le 03/2021).

Ils contiennent des informations sur le remplacement de certaines pièces de rechange précises, y compris des mises en garde.

Pour toute question, veuillez contacter notre service après-vente. Notre responsabilité pour les dommages est conditionnelle à l'observation des conseils de réparation.

## 1.2 Explication des symboles

### 1.2.1 Niveaux de risque

Les niveaux de risque se composent d'un symbole et d'un terme d'avertissement. Le mot d'avertissement caractérise la gravité du danger.









Niveau de dangerosité	Signification
 <b>DANGER</b>	Le non respect de la consigne d'avertissement provoque la mort ou des blessures graves.
 <b>AVERTISSEMENT</b>	Le non respect de la consigne d'avertissement peut provoquer la mort ou des blessures graves.
 <b>PRUDENCE</b>	Le non respect de la consigne d'avertissement peut provoquer des blessures légères.
 <b>ATTENTION !</b>	Le non respect de la consigne d'avertissement peut provoquer des dégâts matériels.

Tableau 1: Niveaux de risque

### 1.2.2 Symboles de danger

Les symboles de danger sont des représentations figuratives renseignant sur la nature du danger.

Ce document utilise les symboles de danger suivants:

Symbole de danger	Signification
	Consigne d'avertissement générale
	Danger engendré par la tension électrique
	Risque d'explosion
	Risque de blessures par coupure

## **i** A propos de ce document





Symbole de danger	Signification
	Risque de blessures par écrasement
	Danger engendré par des surfaces très chaudes
	Danger engendré par un champ magnétique puissant
	Danger engendré par un rayonnement non ionisant

Tableau 2: Symboles de danger

### 1.2.3 Structure des indications d'avertissement

Les consignes d'avertissement figurant dans ce document ont un aspect uniforme et une structure uniforme.

	<p><b>⚠ DANGER</b></p> <p><b>Type et source du danger !</b>            Conséquences possibles en cas de non-respect du danger / de l'avertissement.</p> <ul style="list-style-type: none"> <li>▶ Mesures et interdictions pour éviter le danger.</li> </ul>
--	---

L'exemple suivant montre une consigne d'avertissement mettant en garde contre le risque d'électrocution. La mesure permettant d'éviter le danger est nommée.

	<p><b>⚠ DANGER</b></p> <p><b>Risque d'électrocution par des pièces conductrices de tension !</b>            Mort par électrocution.</p> <ul style="list-style-type: none"> <li>▶ Débrancher l'appareil du secteur minimum 60 secondes avant de démarrer la réparation.</li> </ul>
--	---

### 1.2.4 Symboles généraux

Ce document utilise les symboles généraux suivants:







Symbole général	Signification
	Caractérisation d'une astuce particulière (texte et/ou graphique)
	Caractérisation d'une astuce simple (texte seul)
	Caractérisation d'un lien vers une vidéo
	Caractérisation d'outils nécessaires
	Caractérisation de conditions nécessaires
	Caractérisation d'une condition (si... , alors ...)
	Caractérisation d'un résultat
Start	Caractérisation d'une touche ou surface de commande
[00123456]	Caractérisation d'une référence de pièce
Statut	Caractérisation d'un texte affiché / fenêtre (sur l'afficheur)

Tableau 3: Symboles généraux



## 2.1 Consignes de sécurité générales

### 2.1.1 Tous les appareils électroménagers

#### **Risque d'électrocution en raison de pièces sous tension!**

- Des erreurs lors de réparations impliquant des composants électriques peuvent entraîner une décharge électrique!
- Débrancher l'appareil du secteur minimum 60 secondes avant de démarrer la réparation.
- Après la réparation, effectuer un test de sécurité selon VDE 0701 ou les réglementations spécifiques nationales.

#### **Risque de blessures par coupure sur des bords tranchants!**

- Porter des gants de protection.

#### **Risque de casse durant la réparation, maintenance, dépannage et SAV en raison de composants lourds et mobiles**

- Porter des chaussures de protection.
- Sécuriser les composants lourds contre le risque de chute.
- Ne pas coller les pièces du châssis sur les composants mobiles.



#### **Risque lié à la sécurité / fonction de l'appareil!**

- Utiliser uniquement des pièces détachées d'origine.

#### **Risque d'endommagement des composants sensibles aux décharges électrostatiques!**

- Ne pas toucher les modules, ni leur connexions et pistes conductrices.

## Outils et aides

Désignation	Détails	Images
Tissu de protection [00342013]	60 cm x 50 cm	
Tournevis Philips PH2		
Embout Torx TX20 [00340865]	6,3 mm (1/4")	
Tournevis plat	Lame 2.4 mm x 0.4 mm x 60 mm, dans le kit [00341820]	

## 4.1 Remplacer le joint de porte

### Pré-requis:

- ✔ La porte est ouverte.

### 4.1.1 Retirer le joint de porte

1. Sortir le joint de porte de la rainure dans les coins gauche et droit.





2. Retirer le joint de porte de la rainure.



- ➡ Le joint de porte est retiré.

### 4.1.2 Monter le joint de porte

	L'épaisseur du nouveau joint de porte peut différer légèrement de celle de l'ancien. Cela n'affectera en rien la fermeture ou le fonctionnement à long terme de la porte.
	Si votre appareil est doté de charnière ou d'attaches de charnières ajustables, vous pourrez optimiser le comportement de fermeture par la suite.
	Les petits trous latéraux dans les joints de porte sont fonctionnels (nécessaires pour la ventilation). Il ne s'agit pas de défauts de production.

## Réparation

1. S'assurer de l'absence de dégâts dans les rainures qui doivent accueillir le joint.



4. Pousser les coins du joint en haut et en bas dans la rainure.

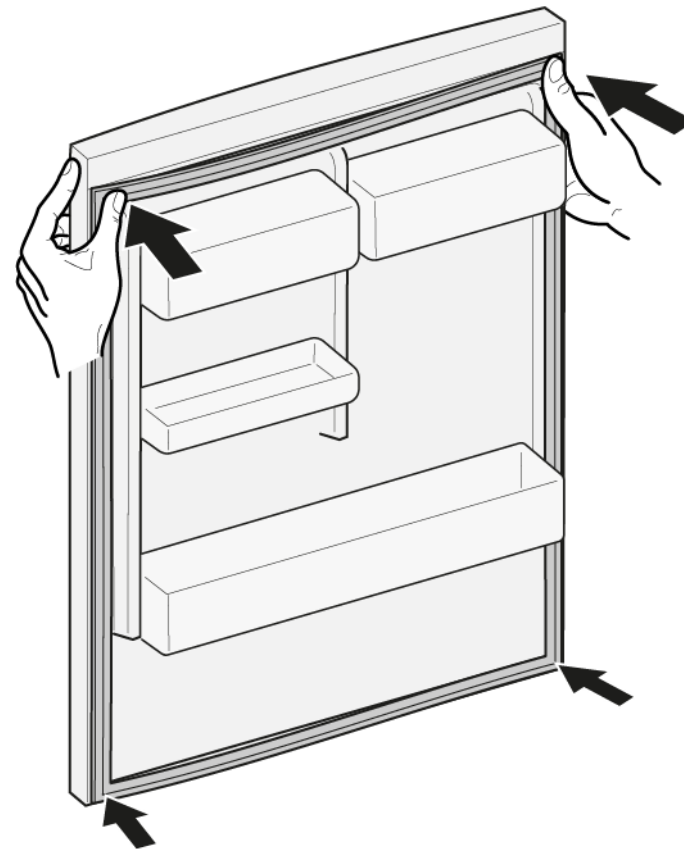

2.  Si la rainure de joint est endommagée.  
- Contacter le service après-vente.

3.  Une légère déformation du joint est normale et ne saurait en affecter le fonctionnement. Il est recommandé de redresser le joint de porte avant de l'insérer dans l'appareil.

Réchauffer le joint de porte avec un sèche-cheveux ou de l'eau chaude et le reformer manuellement.

## Réparation



5. Enfoncer progressivement le joint dans la rainure.





-  Le joint de porte est installé.

## 4.2 Remplacer la poignée de porte

### Outillage nécessaire:

-  Embout Torx TX20                      6,3 mm (1/4")                      [00340865]
-  Tournevis plat                      Lame 10 mm x 1,6 mm x 200 mm

### Pré-requis:

-  Appareil est déconnecté de l'alimentation.
-  La porte est ouverte.

### 4.2.1 Retirer la poignée de porte

- ▶ 1. Retirer deux capuchons de vis (1).
- ▶ 2. Dévisser deux vis (2).
- ▶ 3. Retirer la poignée de porte (3).

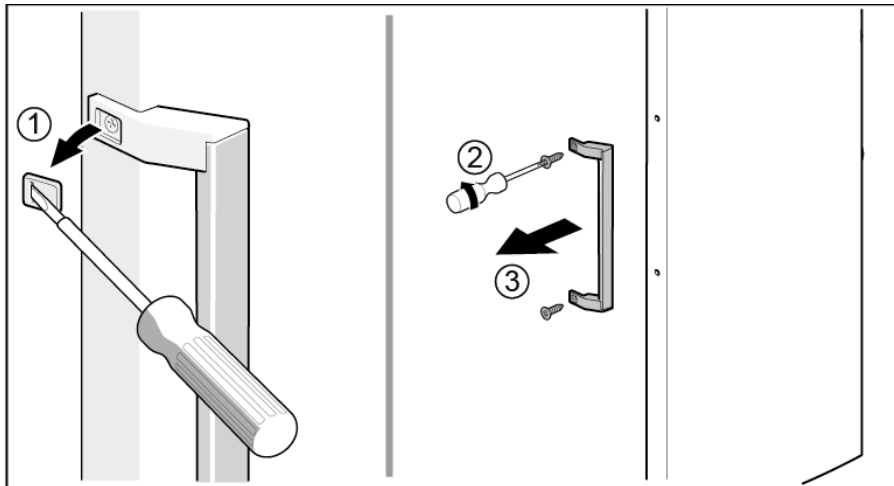

-  La poignée de porte est retirée.

### 4.2.2 Monter la poignée de porte



- ▶ Le montage s'effectue dans l'ordre chronologique inverse.

## 4.3 Echange de la poignée à ouverture facile

### Outillage nécessaire:

-  Tournevis Philips PH2

### Pré-requis:

-  Appareil est déconnecté de l'alimentation.
-  La porte est ouverte.

### 4.3.1 Retrait de la poignée à ouverture facile

- ▶ 1. Retirer le cache de la poignée à ouverture facile (1).
- ▶ 2. Dévisser les deux vis (2).

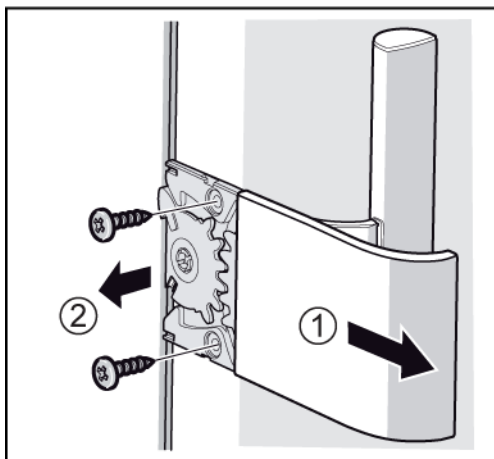

-  La poignée à ouverture facile est retirée.

### 4.3.2 Montage de la poignée à ouverture facile

Le mécanisme de poignée à ouverture facile doit être correctement réglé avant montage.

La disposition correcte de la tige poussoir (1), des quadrants dentés (2) et (3), du ressort (4) et de la butée (5) pour le montage de la porte côté gauche est indiquée dans le graphique.

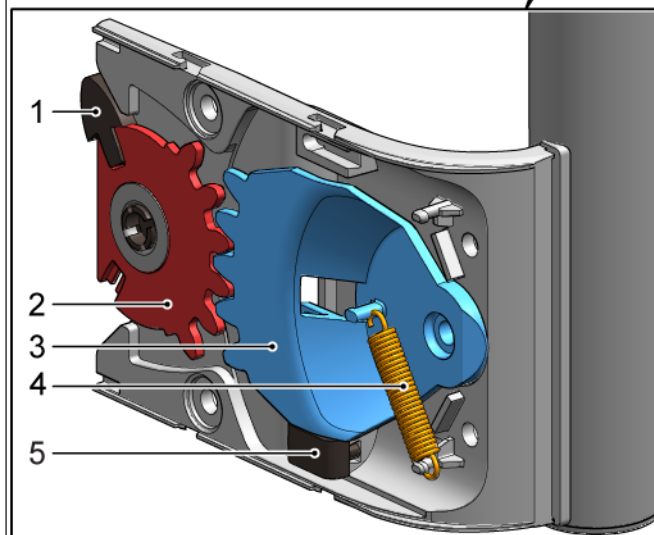
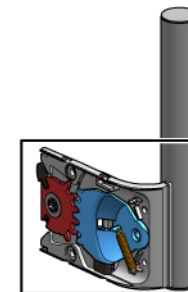

Le positionnement des sous-composants de la poignée d'ouverture facile pour l'installation de la porte côté droit est décrit dans le document « Manuel d'installation ».

- ▶ Le montage s'effectue dans l'ordre chronologique inverse.

## 4.4 Remplacer la charnière supérieure de la porte

### Outillage nécessaire:

 Embout Torx TX20      6,3 mm (1/4")      [00340865]

	<b>⚠ AVERTISSEMENT</b>
	<b>Appareils lourds et volumineux !</b> Blessures dorsales et musculaires <ul style="list-style-type: none"><li>▶ Seuls des spécialistes dûment formés devraient retirer la porte de l'appareil.</li><li>▶ Pour déplacer l'appareil, deux personnes sont nécessaires.</li><li>▶ Utiliser seulement des outils et de l'équipement appropriés.</li></ul>

	<b>⚠ PRUDENCE</b>
	<b>Arêtes vives !</b> Blessures par coupure <ul style="list-style-type: none"><li>▶ Porter des gants de protection.</li></ul>

	<b>⚠ AVERTISSEMENT</b>
	<b>Chute d'appareils inclinés !</b> Fractures/blessures d'écrasement <ul style="list-style-type: none"><li>▶ Sécuriser les appareils contre le risque de chute.</li></ul>

	<b>⚠ PRUDENCE</b>
	<b>Risque de pièces qui chutent en raison de vis trop lâches !</b> Blessures dues à des pièces qui chutent. <ul style="list-style-type: none"><li>▶ Sécuriser les composants contre le risque de chute.</li></ul>

	<b>ATTENTION !</b>
	<b>Risque de pièces qui chutent en raison de vis trop lâches !</b> Dommages à d'autres parties de l'appareil ou à la propriété du client, p. ex. au plancher. <ul style="list-style-type: none"><li>▶ Sécuriser les composants contre le risque de chute.</li></ul>

### Pré-requis:

- ✓ Appareil est déconnecté de l'alimentation.
- ✓ Les équipements intérieurs de l'appareil sont retirés.

## 4.4.1 Retirer la charnière de porte



## Réparation

1. Placer l'appareil sur le dos.

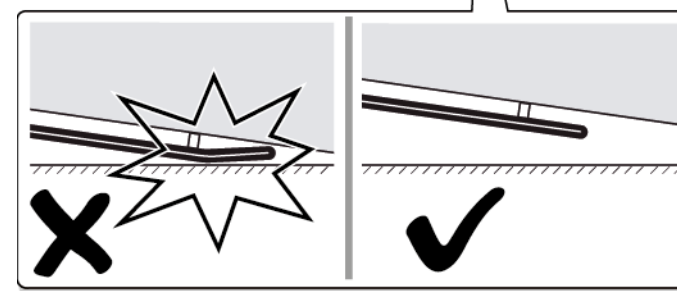
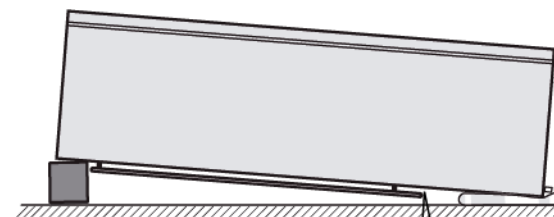
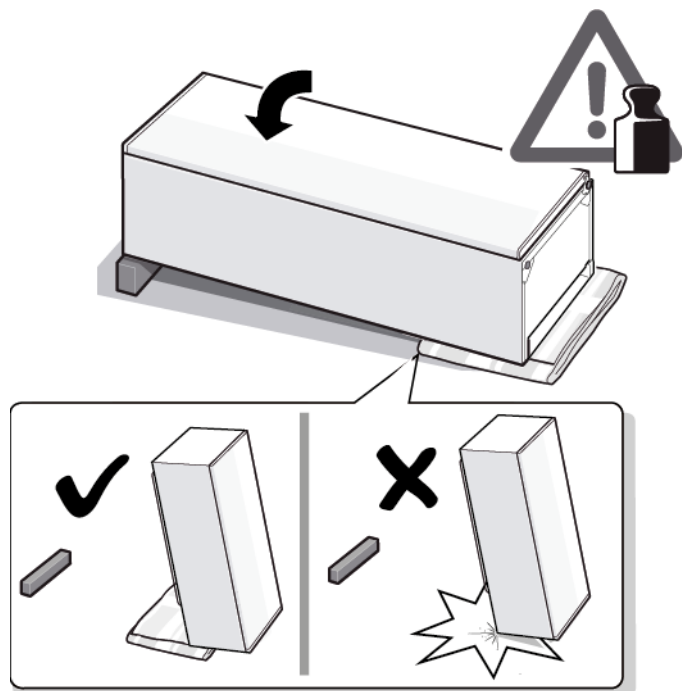

2. 1. Appuyer sur le cache de charnière supérieure des deux côtés (1).  
2. Sortir le cache de charnière supérieure (2).  
3. Retirer le cache de la charnière supérieure (3).

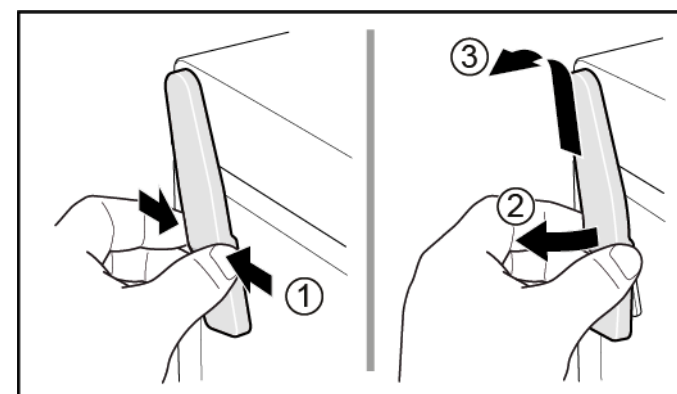

## Réparation

3.
  1. Dévisser deux vis (1).
  2. Retirer la charnière supérieure (2).

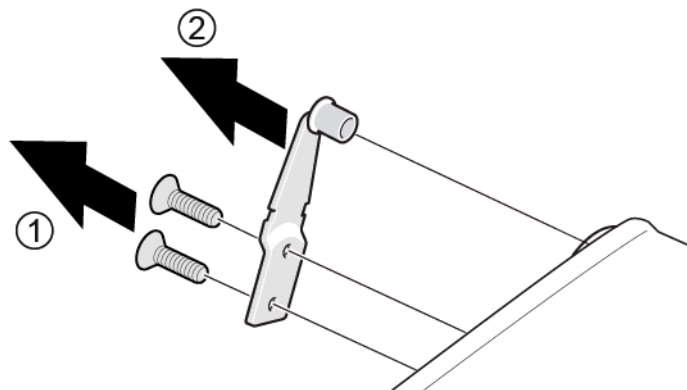

 La charnière supérieure de la porte est retirée.

### 4.4.2 Monter la charnière de porte

- ▶ Le montage s'effectue dans l'ordre chronologique inverse.

## 4.5 Remplacer la charnière supérieure de la porte (porte avec afficheur)

### Outillage nécessaire:

 Embout Torx TX20      6,3 mm (1/4")      [00340865]

	<b>⚠ AVERTISSEMENT</b>
	<p><b>Appareils lourds et volumineux !</b> Blessures dorsales et musculaires</p> <ul style="list-style-type: none"> <li>▶ Seuls des spécialistes dûment formés devraient retirer la porte de l'appareil.</li> <li>▶ Pour déplacer l'appareil, deux personnes sont nécessaires.</li> <li>▶ Utiliser seulement des outils et de l'équipement appropriés.</li> </ul>

	<b>⚠ PRUDENCE</b>
	<p><b>Arêtes vives !</b> Blessures par coupure</p> <ul style="list-style-type: none"> <li>▶ Porter des gants de protection.</li> </ul>

	<b>⚠ AVERTISSEMENT</b>
	<p><b>Chute d'appareils inclinés !</b> Fractures/blessures d'écrasement</p> <ul style="list-style-type: none"> <li>▶ Sécuriser les appareils contre le risque de chute.</li> </ul>



	<b>⚠ PRUDENCE</b>
	<p><b>Risque de pièces qui chutent en raison de vis trop lâches !</b> Blessures dues à des pièces qui chutent.</p> <ul style="list-style-type: none"> <li>▶ Sécuriser les composants contre le risque de chute.</li> </ul>

	<b>ATTENTION !</b>
	<p><b>Risque de pièces qui chutent en raison de vis trop lâches !</b> Dommages à d'autres parties de l'appareil ou à la propriété du client, p. ex. au plancher.</p> <ul style="list-style-type: none"> <li>▶ Sécuriser les composants contre le risque de chute.</li> </ul>

	<b>⚠ DANGER</b>
	<p><b>Risque d'électrocution en raison de pièces sous tension !</b> Risque d'électrocution en cas de réparation non conforme</p> <ul style="list-style-type: none"> <li>▶ Les pièces électriques doivent être réparées par des techniciens qualifiés.</li> <li>▶ Après la réparation, effectuer un test de sécurité selon VDE 0701 ou les réglementations spécifiques nationales.</li> </ul>

	<b>⚠ DANGER</b>
	<p><b>Risque d'électrocution par des pièces conductrices de tension !</b> Mort par électrocution.</p> <ul style="list-style-type: none"> <li>▶ Débrancher l'appareil du secteur minimum 60 secondes avant de démarrer la réparation.</li> </ul>

### Pré-requis:

-  Appareil est déconnecté de l'alimentation.
-  Les équipements intérieurs de l'appareil sont retirés.

## 4.5.1 Retirer la charnière de porte

1. Placer l'appareil sur le dos.

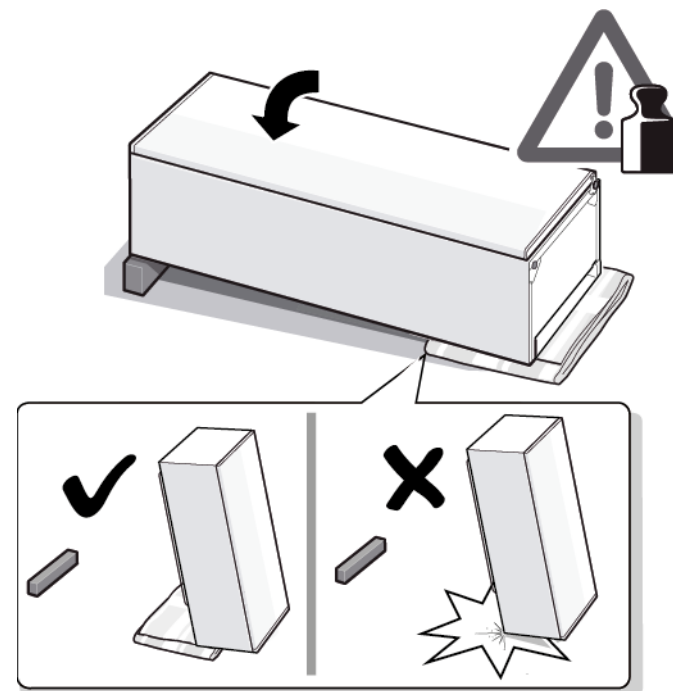

## Réparation

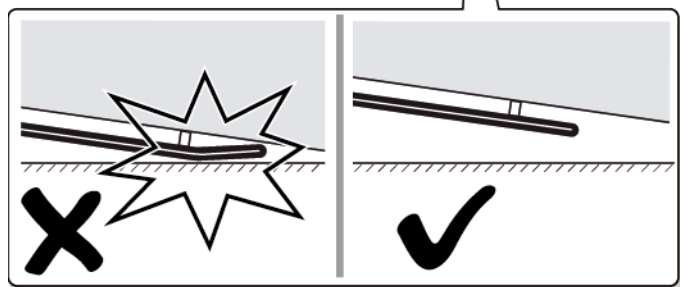
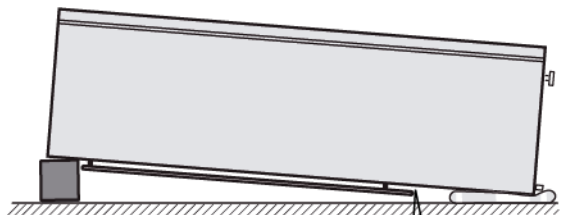

1. Appuyer sur le cache de charnière supérieure des deux côtés (1).
2. Sortir le cache de charnière supérieure (2).
3. Retirer le cache de la charnière supérieure (3).

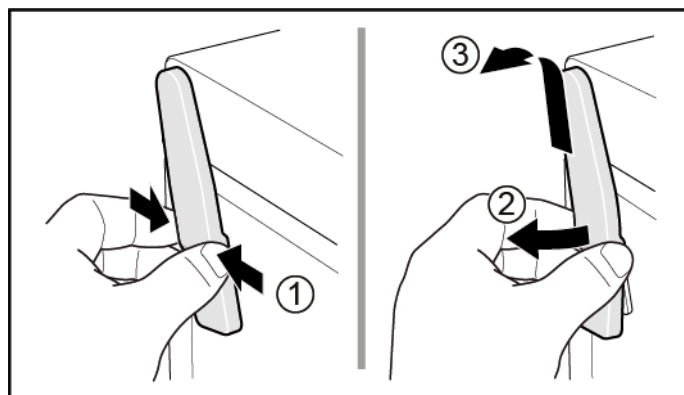

1. Retirer le couvercle de la boîte de câbles (1).
2. Retirer la protection du câble (2).
3. Débrancher la connexion électrique (3).
4. Dévisser deux vis (4).
5. Retirer la charnière supérieure (5).

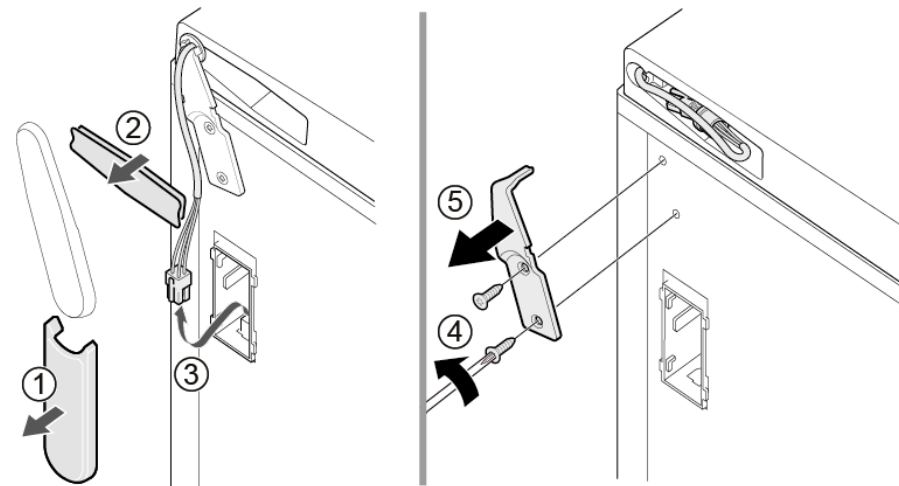

➡ La charnière supérieure de la porte est retirée.

### 4.5.2 Monter la charnière de porte

- ▶ Le montage s'effectue dans l'ordre chronologique inverse.

## 4.6 Remplacer la charnière de porte inférieure

Outillage nécessaire:

🔧 Embout Torx TX20      6,3 mm (1/4")      [00340865]

	<b>⚠️ AVERTISSEMENT</b>
	<p><b>Appareils lourds et volumineux !</b> Blessures dorsales et musculaires</p> <ul style="list-style-type: none"> <li>▶ Seuls des spécialistes dûment formés devraient retirer la porte de l'appareil.</li> <li>▶ Pour déplacer l'appareil, deux personnes sont nécessaires.</li> <li>▶ Utiliser seulement des outils et de l'équipement appropriés.</li> </ul>

	<b>⚠️ PRUDENCE</b>
	<p><b>Arêtes vives !</b> Blessures par coupure</p> <ul style="list-style-type: none"> <li>▶ Porter des gants de protection.</li> </ul>

	<b>⚠️ AVERTISSEMENT</b>
	<p><b>Chute d'appareils inclinés !</b> Fractures/blessures d'écrasement</p> <ul style="list-style-type: none"> <li>▶ Sécuriser les appareils contre le risque de chute.</li> </ul>

	<b>⚠️ PRUDENCE</b>
	<p><b>Risque de pièces qui chutent en raison de vis trop lâches !</b> Blessures dues à des pièces qui chutent.</p> <ul style="list-style-type: none"> <li>▶ Sécuriser les composants contre le risque de chute.</li> </ul>

	<b>ATTENTION !</b>
	<p><b>Risque de pièces qui chutent en raison de vis trop lâches !</b> Dommages à d'autres parties de l'appareil ou à la propriété du client, p. ex. au plancher.</p> <ul style="list-style-type: none"> <li>▶ Sécuriser les composants contre le risque de chute.</li> </ul>

Pré-requis:

- ✅ Appareil est déconnecté de l'alimentation.
- ✅ Les équipements intérieurs de l'appareil sont retirés.
- ✅ L'appareil est placé sur le dos.

✅ [La charnière supérieure est retirée. → 195](#)

### 4.6.1 Remplacer la charnière de porte inférieure

1. Retirer la porte.

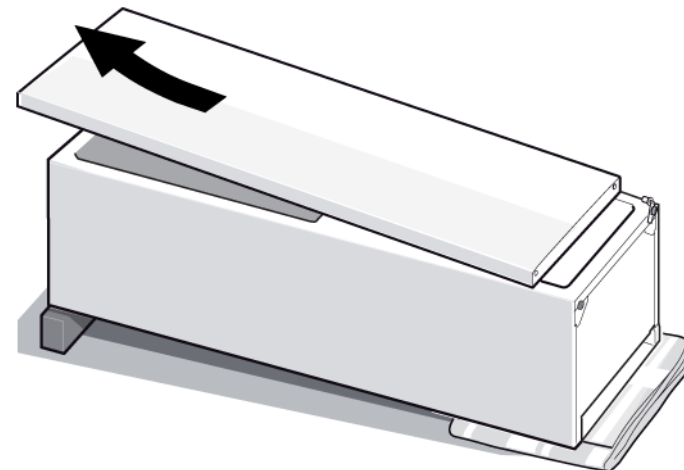

- 2.
1. Dévisser la vis (1).
  2. Extraire la charnière inférieure en la tournant (2).
  3. Retirer la charnière inférieure (3).

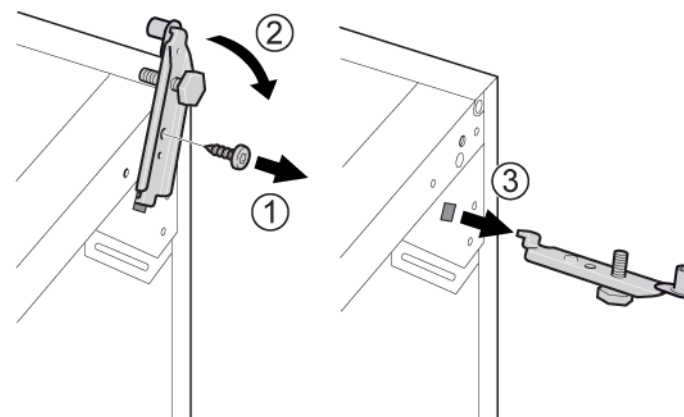

➡ La charnière inférieure est retirée.

### 4.6.2 Monter la charnière de porte inférieure

- ▶ Le montage s'effectue dans l'ordre chronologique inverse.

## 4.7 Remplacer la tablette

### Pré-requis:

- ✔ La porte est ouverte.

### 4.7.1 Retirer la tablette

- ▶ Extraire la tablette.

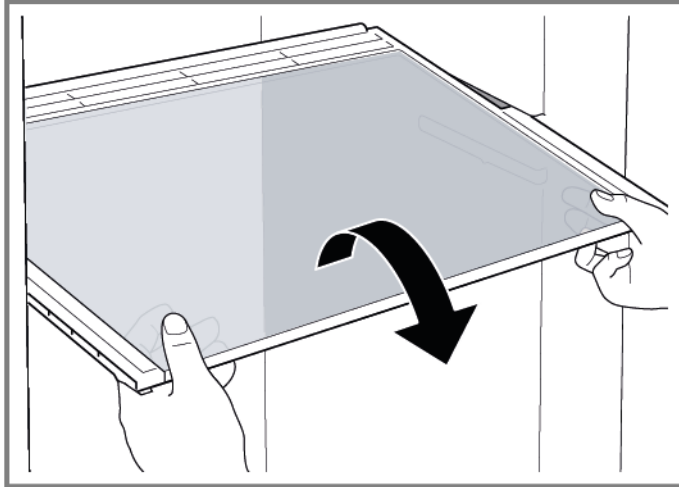

- ➡ La tablette est retirée.

### 4.7.2 Monter la tablette

- ▶ Le montage s'effectue dans l'ordre chronologique inverse.



## 4.8 Remplacer le bac d'aliments congelés

### Pré-requis:

- ✔ La porte est ouverte.

### 4.8.1 Retirer le bac d'aliments congelés

- ▶ 1. Extraire complètement le bac d'aliments congelés (1).
- ▶ 2. Retirer le bac d'aliments congelés (2).

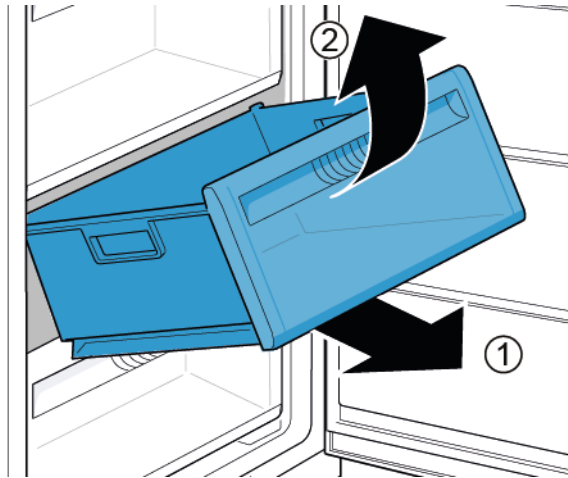

- ➡ Le bac d'aliments congelés est retiré.

### 4.8.2 Monter le bac d'aliments congelés

- ▶ Le montage s'effectue dans l'ordre chronologique inverse.

## 4.9 Remplacer la fabrique de glace

### Pré-requis:

- ✔ La porte est ouverte.

### 4.9.1 Retirer la fabrique de glace

- ▶ 1. Extraire complètement le tiroir bac d'aliments congelés avec la fabrique de glace (1).
- ▶ 2. Décrocher les crochets (2).
- ▶ 3. Retirer la fabrique de glace (3).

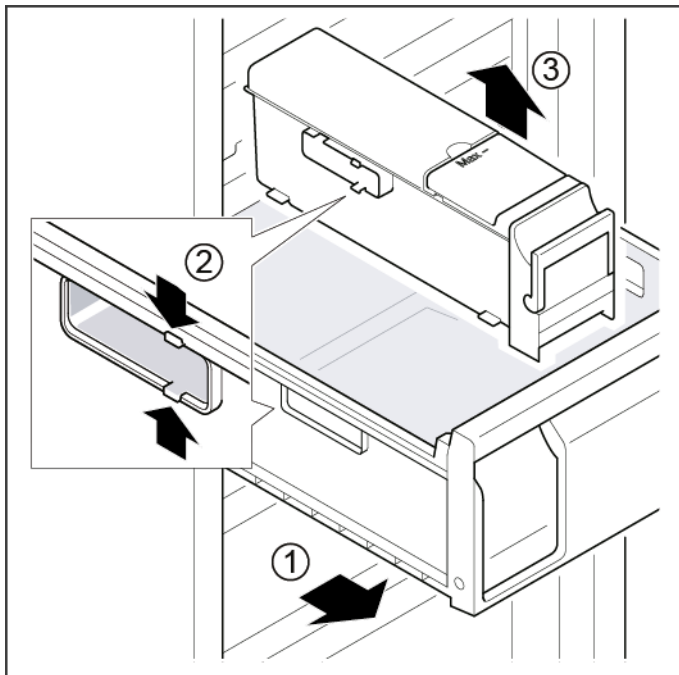

- ➡ La fabrique de glace est retirée.

### 4.9.2 Monter la fabrique de glace

- ▶ Le montage s'effectue dans l'ordre chronologique inverse.

## 4.10 Remplacer l'éclairage LED supérieur

### Outillage nécessaire:

-  Tournevis plat      Lame 2.4 mm x 0.4 mm x 60 mm, dans le kit [00341820]

 Votre appareil comprend un éclairage LED sans maintenance. Ces lampes peuvent être réparées exclusivement par le service après-vente ou un technicien autorisé.

 **DANGER**  
**Risque d'électrocution en raison de pièces sous tension !**  
Risque d'électrocution en cas de réparation non conforme

- ▶ Les pièces électriques doivent être réparées par des techniciens qualifiés.
- ▶ Après la réparation, effectuer un test de sécurité selon VDE 0701 ou les réglementations spécifiques nationales.



 **DANGER**  
**Risque d'électrocution par des pièces conductrices de tension !**  
Mort par électrocution.

- ▶ Débrancher l'appareil du secteur minimum 60 secondes avant de démarrer la réparation.

 **PRUDENCE**  
**Arêtes vives !**  
Blessures par coupure

- ▶ Porter des gants de protection.

### Pré-requis:

-  Appareil est déconnecté de l'alimentation.
-  La porte est ouverte.
-  Les équipements intérieurs supérieurs de l'appareil sont retirés.

### 4.10.1 Retirer l'éclairage LED

1. Déplacer l'éclairage LED vers la gauche.

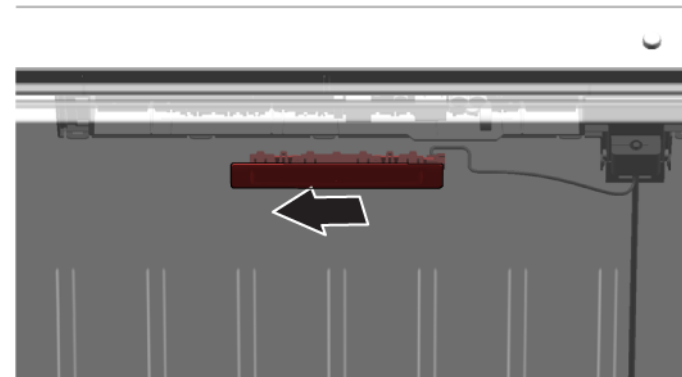

-  Connexion électrique de l'éclairage LED est débranchée.

2. Libérer les crochets de l'éclairage LED.

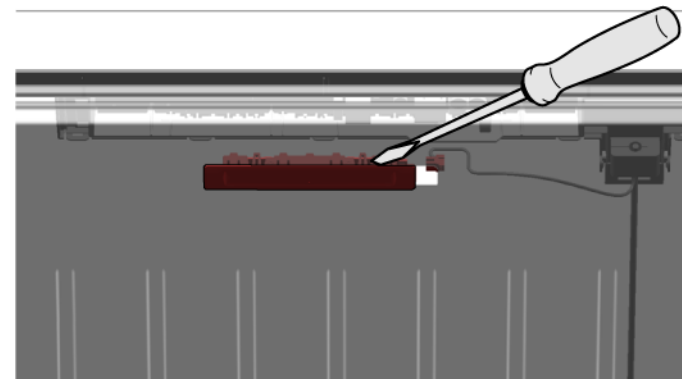

3. Retirer l'éclairage LED par l'avant.

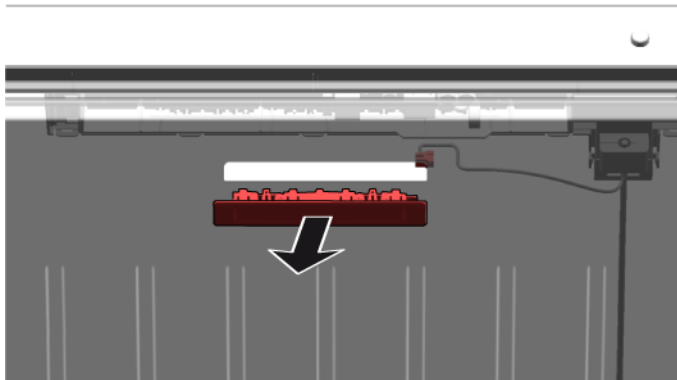

- ➔ L'éclairage LED est retiré.

### 4.10.2 Monter l'éclairage LED supérieur

- ▶ Le montage s'effectue dans l'ordre chronologique inverse.

# Reparatur Hinweise - Gefrierschrank

## **Zu diesem Dokument.....206**

1.1	Wichtige Hinweise: .....	206
1.1.1	Zweck .....	206
1.2	Zeichenerklärung.....	206
1.2.1	Gefahrenstufen .....	206
1.2.2	Gefahrensymbole.....	206
1.2.3	Struktur der Warnhinweise.....	207
1.2.4	Allgemeine Symbole .....	207

## **Sicherheit.....208**

2.1	Allgemeine Sicherheitshinweise .....	208
2.1.1	Alle Hausgeräte .....	208

## **Werkzeuge und Hilfsmittel.....209**

## **Instandsetzen .....210**

4.1	Austauschen der Türdichtung.....	210
4.1.1	Ausbauen der Türdichtung.....	210
4.1.2	Einbauen der Türdichtung .....	210
4.2	Austauschen des Türgriffs.....	213
4.2.1	Ausbauen des Türgriffs .....	213
4.2.2	Einbauen des Türgriffs .....	213
4.3	Austauschen des Griffs zum bequemen Öffnen.....	214
4.3.1	Ausbauen des Griffs zum bequemen Öffnen.....	214
4.3.2	Einbauen des Griffs zum bequemen Öffnen.....	214
4.4	Austauschen des oberen Türscharniers .....	215
4.4.1	Ausbauen des Türscharniers .....	215
4.4.2	Einbauen des Türscharniers .....	217
4.5	Austauschen des oberen Türscharniers (Tür mit Anzeige) .....	218
4.5.1	Ausbauen des Türscharniers .....	219
4.5.2	Einbauen des Türscharniers .....	220
4.6	Austauschen des unteren Türscharniers .....	221
4.6.1	Austauschen des unteren Türscharniers.....	221
4.6.2	Einbauen des unteren Türscharniers.....	222
4.7	Austauschen der Ablage .....	223
4.7.1	Ausbauen der Ablage.....	223
4.7.2	Einbauen der Ablage.....	223

4.8	Austauschen des Gefriergutbehälters.....	224
4.8.1	Ausbauen des Gefriergutbehälters .....	224
4.8.2	Einbauen des Gefriergutbehälters .....	224
4.9	Austauschen des Eisbereiters.....	225
4.9.1	Ausbauen des Eisbereiters .....	225
4.9.2	Einbauen des Eisbereiters .....	225
4.10	Austauschen des LED-Oberlichts.....	226
4.10.1	Ausbauen der LED-Beleuchtung .....	226
4.10.2	Einbauen des LED-Oberlichts .....	227

# Zu diesem Dokument

## 1.1 Wichtige Hinweise:

### 1.1.1 Zweck

Diese Reparaturhinweise dienen zur Unterstützung des Kunden bei der selbständigen Geräte-Reparatur gemäß der entsprechenden Ökodesign-Richtlinie (ab 03/2021).

Sie enthalten Informationen zum Austausch bestimmter Ersatzteile sowie Warn- und Gefahrenhinweise.

Bitte wenden Sie sich in Zweifelsfällen an unseren Kundendienst. Bei nicht ordnungsgemäßer Befolgung der Reparaturhinweise ist die Schadenshaftung ausgeschlossen.

## 1.2 Zeichenerklärung

### 1.2.1 Gefahrenstufen

Die Gefahrenstufen bestehen aus einem Symbol und einem Signalwort. Das Signalwort kennzeichnet die Schwere der Gefahr.









Gefahrenstufe	Bedeutung
	Nichtbeachtung des Warnhinweises führt zu Tod oder schweren Verletzungen.
	Nichtbeachtung des Warnhinweises kann zu Tod oder schweren Verletzungen führen.
	Nichtbeachtung des Warnhinweises kann zu leichten Verletzungen führen.
	Nichtbeachtung des Warnhinweises kann zu Sachschäden führen.

Tabelle 1: Gefahrenstufen

### 1.2.2 Gefahrensymbole

Gefahrensymbole sind sinnbildliche Darstellungen, die einen Hinweis auf die Art der Gefahr geben.

In diesem Dokument werden folgende Gefahrensymbole verwendet:

Gefahrensymbol	Bedeutung
	Allgemeiner Warnhinweis
	Gefahr durch elektrische Spannung
	Gefahr durch Explosion
	Gefahr von Schnittverletzungen
	Gefahr von Quetschverletzungen

## Zu diesem Dokument





Gefahrensymbol	Bedeutung
	Gefahr durch heiße Oberflächen
	Gefahr durch starkes Magnetfeld
	Gefahr durch nicht ionisierende Strahlung

Tabelle 2: Gefahrensymbole

### 1.2.3 Struktur der Warnhinweise

Warnhinweise haben in diesem Dokument ein einheitliches Aussehen und eine einheitliche Struktur.



	 <b>GEFAHR</b>
	<p><b>Art und Quelle der Gefahr!</b> Mögliche Folgen bei Nichtbeachtung der Gefahr / des Warnhinweises.</p> <ul style="list-style-type: none"> <li>▶ Maßnahmen und Verbote zur Vermeidung der Gefahr.</li> </ul>

Das folgende Beispiel zeigt einen Warnhinweis, der vor Stromschlaggefahr durch spannungsführende Teile warnt. Die Maßnahme zur Vermeidung der Gefahr wird genannt.

	 <b>GEFAHR</b>
	<p><b>Stromschlaggefahr durch spannungsführende Teile!</b> Tod durch Stromschlag</p> <ul style="list-style-type: none"> <li>▶ Gerät mindestens 60 Sekunden vor Reparaturbeginn vom Netz trennen.</li> </ul>

### 1.2.4 Allgemeine Symbole

In diesem Dokument werden folgende allgemeine Symbole verwendet:

Allg. Symbol	Bedeutung
	Kennzeichnung eines besonderen (Text und/oder Grafik) Tipps
	Kennzeichnung eines einfachen (nur Text) Tipps





Allg. Symbol	Bedeutung
	Kennzeichnung eines Links zu einer Videoanleitung
	Kennzeichnung erforderlicher Werkzeuge
	Kennzeichnung erforderlicher Voraussetzungen
	Kennzeichnung einer Bedingung (Wenn ..., dann ...)
	Kennzeichnung eines Ergebnisses
[Start]	Kennzeichnung einer Taste oder Schaltfläche
[00123456]	Kennzeichnung einer Materialnummer
Status	Kennzeichnung eines angezeigten Textes / Fensters (im Gerätedisplay)

Tabelle 3: Allgemeine Symbole

## 2.1 Allgemeine Sicherheitshinweise

### 2.1.1 Alle Hausgeräte

#### **Stromschlaggefahr durch spannungsführende Teile!**

- Wenn elektrische Komponenten fehlerhaft repariert werden, besteht Stromschlaggefahr!
- Das Gerät mindestens 60 Sekunden vor Beginn der Arbeiten vom Netz trennen.
- Nach der Reparatur muss eine Sicherheitsprüfung nach VDE 0701 oder länderspezifischen Vorschriften durchgeführt werden.

#### **Verletzungsgefahr durch scharfe Kanten!**

- Schutzhandschuhe tragen.

#### **Quetschgefahr während Reparatur-, Wartungs-, Fehlersuche- und Servicearbeiten durch schwere sich bewegende Bauteile**

- Schutzhandschuhe tragen.
- Schwere Bauteile gegen Herabfallen sichern.
- Körperteile nicht in sich bewegende Bauteile stecken.

#### **Gefährdung der Gerätesicherheit/-funktion!**



- Ausschließlich Originalersatzteile verwenden.

#### **Gefahr der Beschädigung elektrostatisch gefährdeter Bauteile (elektrostatische Entladungen)!**

- Die Module, einschließlich ihrer Anschlüsse und Leiterbahnen, keinesfalls berühren.



## Werkzeuge und Hilfsmittel

Bezeichnung	Details	Bilder
Schutztuch [00342013]	60 cm x 50 cm	
Schraubendreher Phillips PH2		
Torx-Bit TX20 [00340865]	6,3 mm (1/4")	
Schlitzschraubendreher	Klinge 2,4 mm x 0,4 mm x 60 mm, im Set [00341820]	

## 4.1 Austauschen der Türdichtung

### Voraussetzung:

- ✔ Die Tür ist offen.

### 4.1.1 Ausbauen der Türdichtung

1. Die Türdichtung aus der Kerbe in der rechten und linken Ecke lösen.

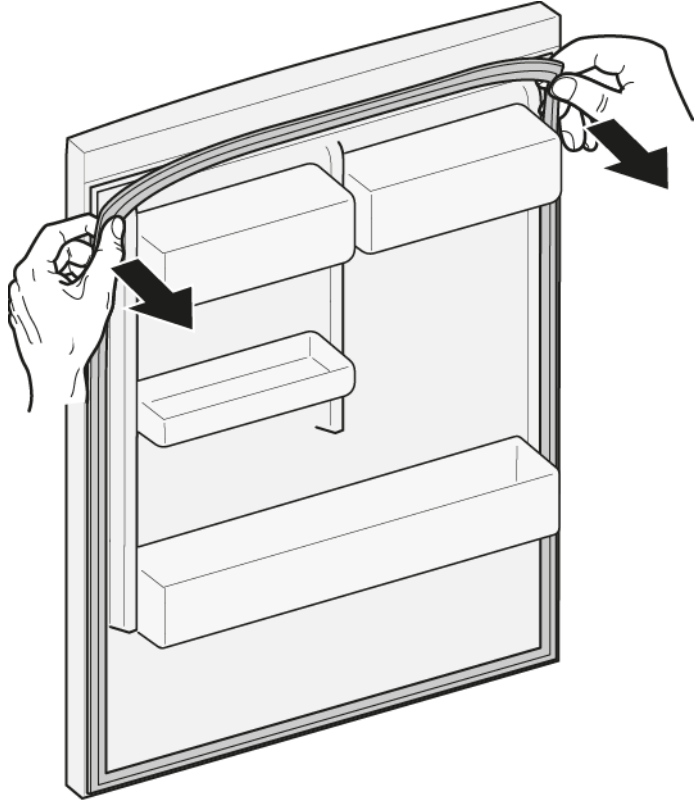

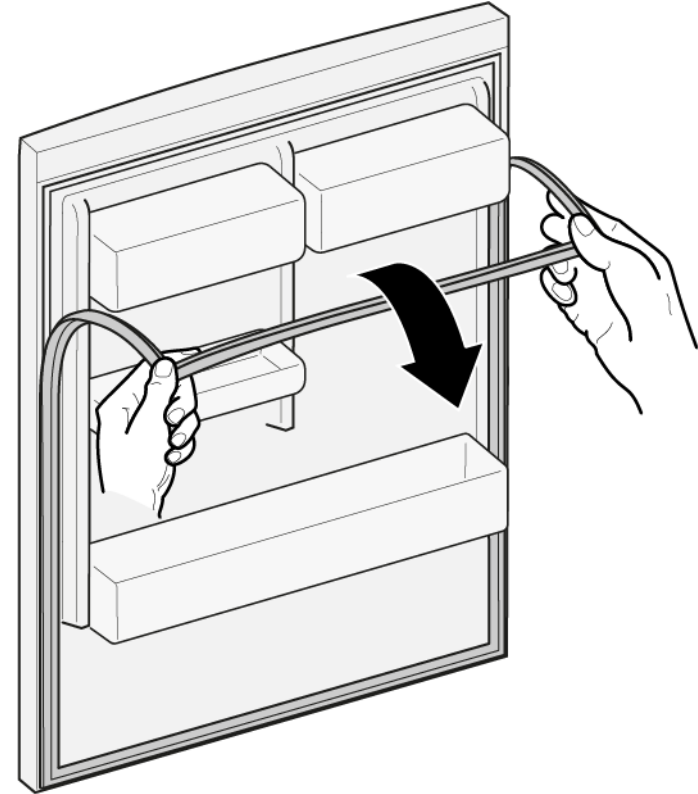

2. Die Türdichtung aus der Kerbe herausziehen.



- ➡ Die Türdichtung ist entfernt.

### 4.1.2 Einbauen der Türdichtung

	Die Dicke neuer Türdichtungen kann geringfügig von der Dicke alter Türdichtungen abweichen. Dies hat auf das Schließverhalten und die langfristige Funktion keinen Einfluss.
	Wenn das Gerät mit einstellbaren Scharnieren oder Scharnierbefestigungen ausgestattet ist, kann das Schließverhalten anschließend optimiert werden.
	Die kleinen seitlichen Löcher in der Türdichtung haben eine wichtige Funktion (für Lüftung erforderlich). Es handelt sich hierbei nicht um Produktionsfehler.

## Instandsetzen

1. Die Dichtungskerbe auf Beschädigungen überprüfen.

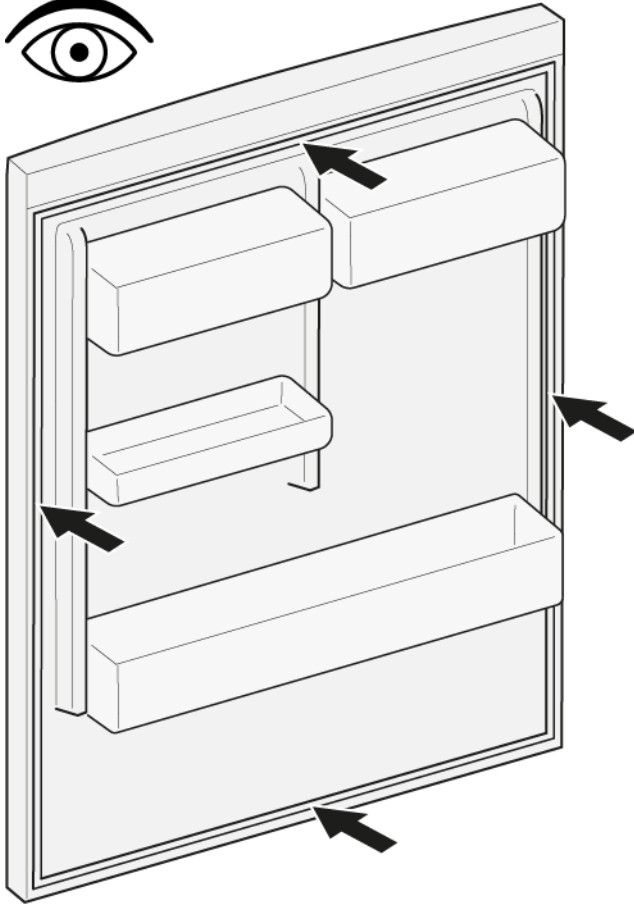

4. Die Dichtungsecken oben und unten in die Kerbe drücken.

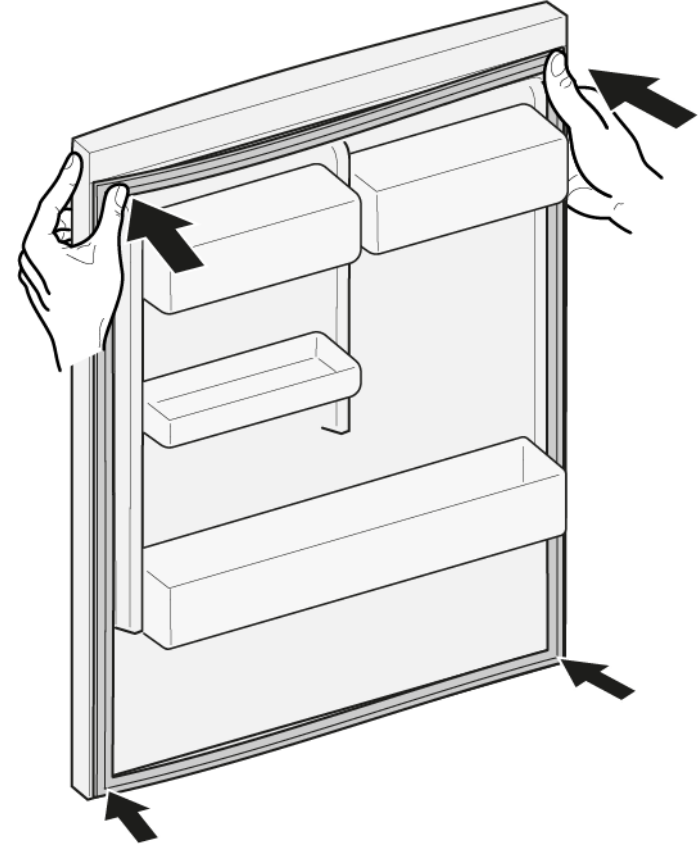

2.  Wenn die Dichtungskerbe beschädigt ist:
  - Den Kundendienst kontaktieren.

3.  Leichte Deformationen der Türdichtung sind normal und beeinträchtigen nicht die Funktion. Es wird empfohlen, die Türdichtung vor dem Einsetzen in das Gerät zu begradigen.

Die Türdichtung mit einem Haartrockner oder mit heißem Wasser erwärmen und von Hand in die richtige Form bringen.

## Instandsetzen

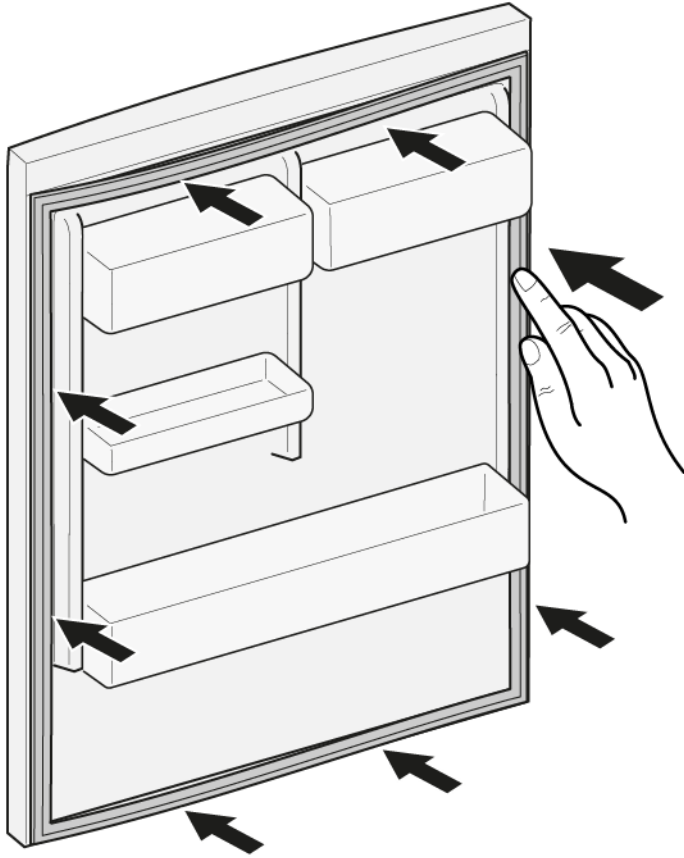

5. Die gesamte Dichtung Stück für Stück in die Kerbe drücken.





-  Die Türdichtung ist eingebaut.

## 4.2 Austauschen des Türgriffs

### Spezielle Hilfsmittel:

-  Torx-Bit TX20 6,3 mm (1/4") [00340865]
-  Schlitzschraubendreher Klinge 10 mm x 1,6 mm x 200 mm

### Voraussetzung:

-  Das Gerät ist spannungsfrei.
-  Die Tür ist offen.

### 4.2.1 Ausbauen des Türgriffs

- ▶ 1. Die beiden Schraubkappen entfernen (1).
- ▶ 2. Die beiden Schrauben herausschrauben (2).
- ▶ 3. Den Türgriff entfernen (3).

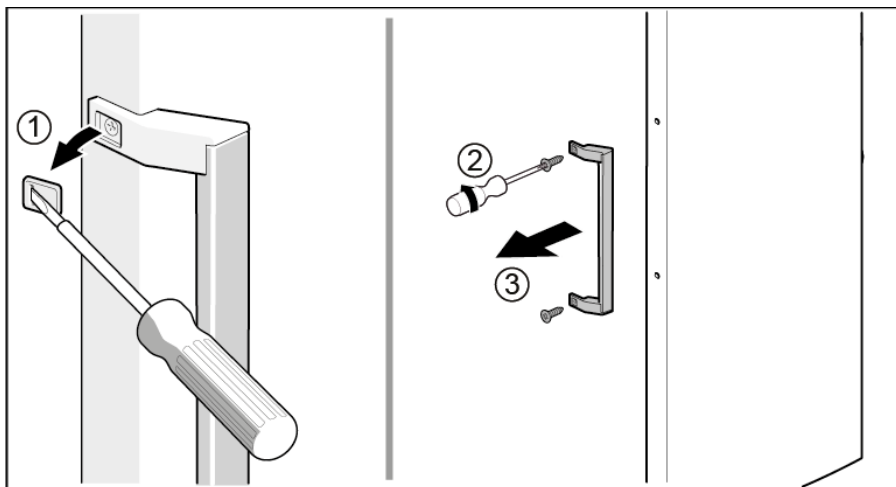

 Der Türgriff ist entfernt.

### 4.2.2 Einbauen des Türgriffs

- ▶ Der Einbau erfolgt in umgekehrter Reihenfolge.

## 4.3 Austauschen des Griffs zum bequemen Öffnen

### Spezielle Hilfsmittel:

- 🔧 Schraubendreher Phillips PH2

### Voraussetzung:

- ✅ Das Gerät ist spannungsfrei.
- ✅ Die Tür ist offen.

### 4.3.1 Ausbauen des Griffs zum bequemen Öffnen

1. Die Abdeckung des Griffs zum bequemen Öffnen entfernen (1).
2. Zwei Schrauben (2) herausschrauben.

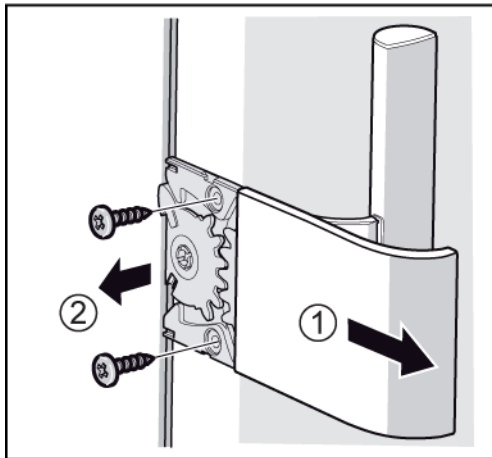

- ➔ Der Griff zum bequemen Öffnen ist entfernt.

## 4.3.2 Einbauen des Griffs zum bequemen Öffnen

Der Mechanismus des Griffs zum bequemen Öffnen muss vor dem Einbauen ordnungsgemäß eingestellt werden. In der Abbildung ist die korrekte Anordnung der Schubstange (1), der Zahnsegmente (2) und (3), der Feder (4) und des Endanschlags (5) für den linksseitigen Türeinbau gezeigt.

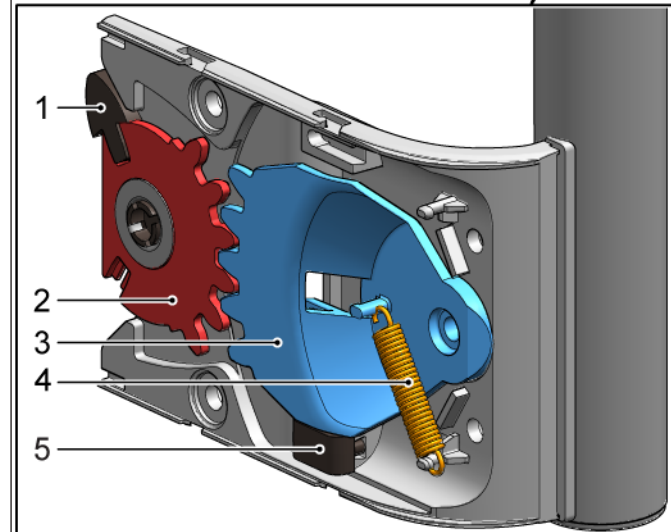
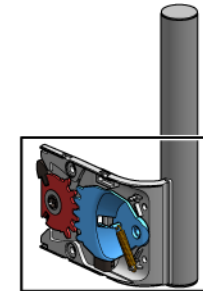



Die Anordnung der Teilkomponenten des Griffs zum bequemen Öffnen für den rechtsseitigen Türeinbau ist im Dokument "Installationsanleitung" beschrieben.

- ➔ Der Einbau erfolgt in umgekehrter Reihenfolge.

## 4.4 Austauschen des oberen Türscharniers

### Spezielle Hilfsmittel:

 Torx-Bit TX20                      6,3 mm (1/4")                      [00340865]

	<b>⚠️ WARNUNG</b>
	<b>Schwere, unhandliche Geräte!</b> Rücken- und Muskelverletzungen <ul style="list-style-type: none"><li>▶ Der Ausbau der Gerätetür sollte nur von geschulten Spezialisten durchgeführt werden.</li><li>▶ Zum Bewegen des Geräts sind zwei Personen erforderlich.</li><li>▶ Nur geeignete Werkzeuge und Vorrichtungen verwenden.</li></ul>

	<b>⚠️ VORSICHT</b>
	<b>Scharfe Kanten!</b> Schnittverletzungen <ul style="list-style-type: none"><li>▶ Schutzhandschuhe tragen.</li></ul>

	<b>⚠️ WARNUNG</b>
	<b>Wegrutschen des gekippten Gerätes!</b> Knochenbrüche / Quetschungen <ul style="list-style-type: none"><li>▶ Gerät gegen Wegrutschen sichern.</li></ul>

	<b>⚠️ VORSICHT</b>
	<b>Risiko herabfallender Teile durch gelöste Schrauben!</b> Verletzungsgefahr durch herabfallende Teile. <ul style="list-style-type: none"><li>▶ Die Komponenten gegen Herunterfallen sichern.</li></ul>

	<b>⚠️ ACHTUNG</b>
	<b>Risiko herabfallender Teile durch gelöste Schrauben!</b> Gefahr der Beschädigung anderer Geräteteile bzw. von Beschädigungen im Haushalt des Kunden, z. B. des Bodens. <ul style="list-style-type: none"><li>▶ Die Komponenten gegen Herunterfallen sichern.</li></ul>

### Voraussetzung:

- ✔ Das Gerät ist spannungsfrei.
- ✔ Die Innenausstattungsteile des Geräts sind entfernt.

## 4.4.1 Ausbauen des Türscharniers

## Instandsetzen

1. Das Gerät auf die Rückseite legen.

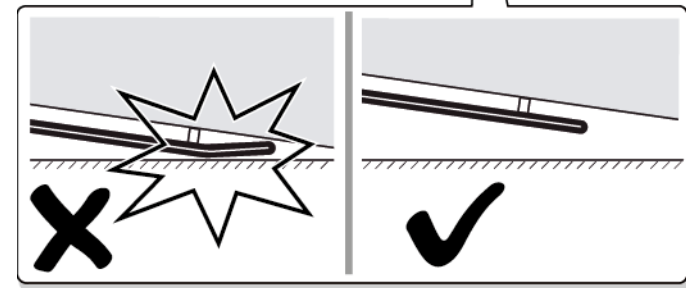
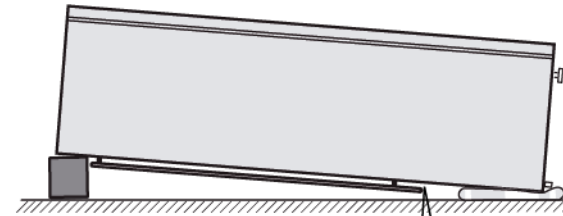
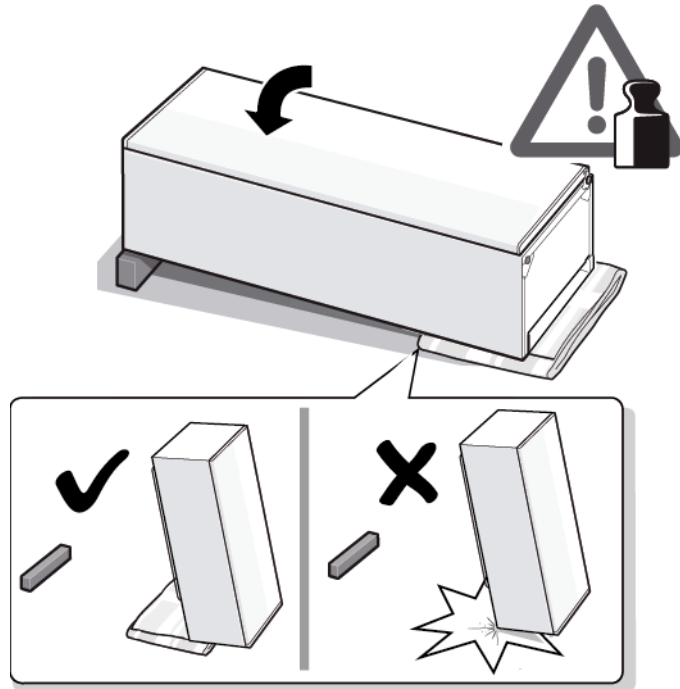

2. 1. Auf beide Seiten der oberen Scharnierabdeckung Druck ausüben (1).  
2. Die obere Scharnierabdeckung abziehen (2).  
3. Die obere Scharnierabdeckung entfernen (3).

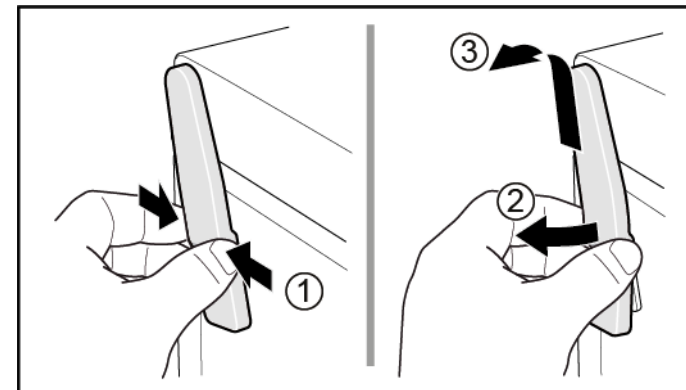



## Instandsetzen

3.
  1. Die beiden Schrauben heraus-schrauben (1).
  2. Das obere Scharnier entfernen (2).

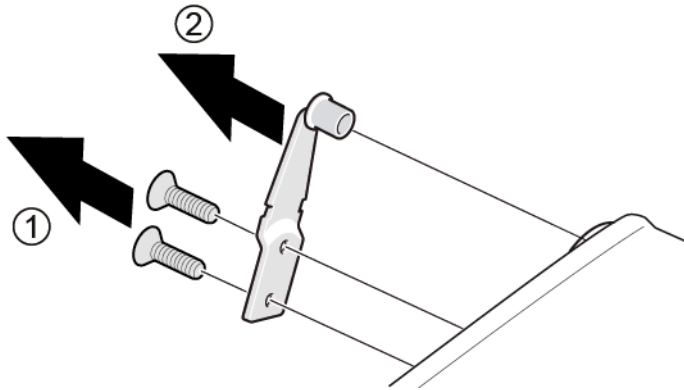

 Das obere Türscharnier ist entfernt.

### 4.4.2 Einbauen des Türscharniers

- ▶ Der Einbau erfolgt in umgekehrter Reihenfolge.

## 4.5 Austauschen des oberen Türscharniers (Tür mit Anzeige)

### Spezielle Hilfsmittel:

 Torx-Bit TX20      6,3 mm (1/4")      [00340865]

	<b>⚠️ WARNUNG</b>
	<p><b>Schwere, unhandliche Geräte!</b> Rücken- und Muskelverletzungen</p> <ul style="list-style-type: none"> <li>▶ Der Ausbau der Gerätetür sollte nur von geschulten Spezialisten durchgeführt werden.</li> <li>▶ Zum Bewegen des Geräts sind zwei Personen erforderlich.</li> <li>▶ Nur geeignete Werkzeuge und Vorrichtungen verwenden.</li> </ul>

	<b>⚠️ VORSICHT</b>
	<p><b>Scharfe Kanten!</b> Schnittverletzungen</p> <ul style="list-style-type: none"> <li>▶ Schutzhandschuhe tragen.</li> </ul>

	<b>⚠️ WARNUNG</b>
	<p><b>Wegrutschen des gekippten Gerätes!</b> Knochenbrüche / Quetschungen</p> <ul style="list-style-type: none"> <li>▶ Gerät gegen Wegrutschen sichern.</li> </ul>



	<b>⚠️ VORSICHT</b>
	<p><b>Risiko herabfallender Teile durch gelöste Schrauben!</b> Verletzungsgefahr durch herabfallende Teile.</p> <ul style="list-style-type: none"> <li>▶ Die Komponenten gegen Herunterfallen sichern.</li> </ul>

	<b>ACHTUNG</b>
	<p><b>Risiko herabfallender Teile durch gelöste Schrauben!</b> Gefahr der Beschädigung anderer Geräteteile bzw. von Beschädigungen im Haushalt des Kunden, z. B. des Bodens.</p> <ul style="list-style-type: none"> <li>▶ Die Komponenten gegen Herunterfallen sichern.</li> </ul>

	<b>⚠️ GEFAHR</b>
	<p><b>Stromschlaggefahr durch spannungsführende Teile!</b> Lebensgefahr durch Stromschlag bei unsachgemäßer Reparatur</p> <ul style="list-style-type: none"> <li>▶ Elektroteile sollten von einer Elektrofachkraft repariert werden.</li> <li>▶ Nach der Reparatur muss eine Sicherheitsprüfung nach VDE 0701 oder länderspezifischen Vorschriften durchgeführt werden.</li> </ul>

	<b>⚠️ GEFAHR</b>
	<p><b>Stromschlaggefahr durch spannungsführende Teile!</b> Tod durch Stromschlag</p> <ul style="list-style-type: none"> <li>▶ Gerät mindestens 60 Sekunden vor Reparaturbeginn vom Netz trennen.</li> </ul>

### Voraussetzung:

-  Das Gerät ist spannungsfrei.
-  Die Innenausstattungsteile des Geräts sind entfernt.

## 4.5.1 Ausbauen des Türscharniers

1. Das Gerät auf die Rückseite legen.

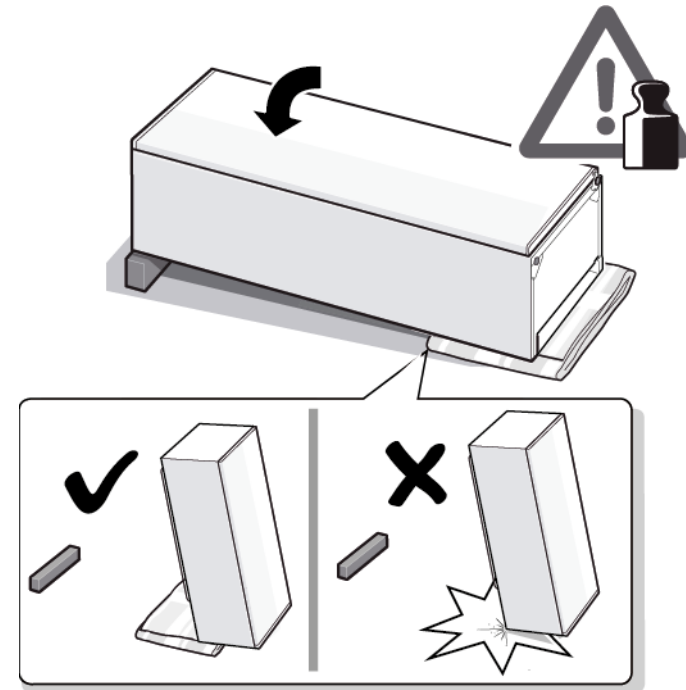

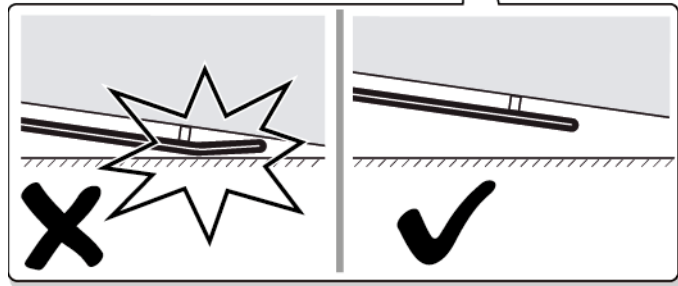
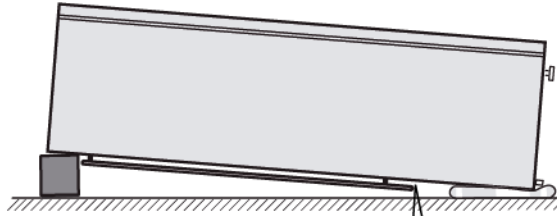

2. 1. Auf beide Seiten der oberen Scharnierabdeckung Druck ausüben (1).
2. Die obere Scharnierabdeckung abziehen (2).
3. Die obere Scharnierabdeckung entfernen (3).

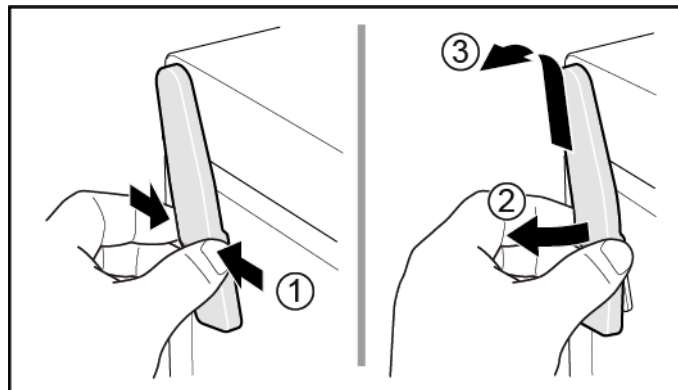

3. 1. Die Kabelboxabdeckung entfernen (1).
2. Den Kabelschutz entfernen (2).
3. Den elektrischen Anschluss trennen (3).
4. Die beiden Schrauben heraus-schrauben (4).
5. Das obere Scharnier entfernen (5).

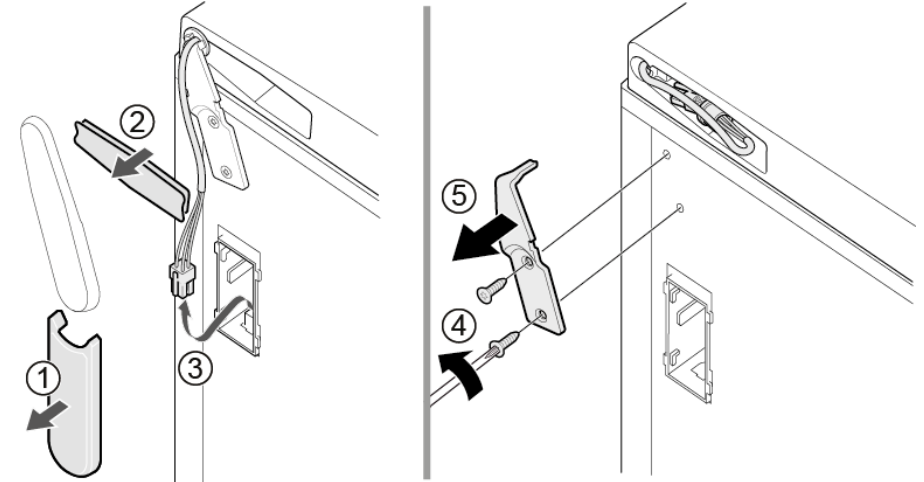

➡ Das obere Türscharnier ist entfernt.

## 4.5.2 Einbauen des Türscharniers

- ▶ Der Einbau erfolgt in umgekehrter Reihenfolge.

## 4.6 Austauschen des unteren Türscharniers

### Spezielle Hilfsmittel:

🔧 Torx-Bit TX20      6,3 mm (1/4")      [00340865]

	<p style="text-align: center;"><b>⚠️ WARNUNG</b></p> <p><b>Schwere, unhandliche Geräte!</b> Rücken- und Muskelverletzungen</p> <ul style="list-style-type: none"> <li>▶ Der Ausbau der Gerätetür sollte nur von geschulten Spezialisten durchgeführt werden.</li> <li>▶ Zum Bewegen des Geräts sind zwei Personen erforderlich.</li> <li>▶ Nur geeignete Werkzeuge und Vorrichtungen verwenden.</li> </ul>
	<p style="text-align: center;"><b>⚠️ VORSICHT</b></p> <p><b>Scharfe Kanten!</b> Schnittverletzungen</p> <ul style="list-style-type: none"> <li>▶ Schutzhandschuhe tragen.</li> </ul>
	<p style="text-align: center;"><b>⚠️ WARNUNG</b></p> <p><b>Wegrutschen des gekippten Gerätes!</b> Knochenbrüche / Quetschungen</p> <ul style="list-style-type: none"> <li>▶ Gerät gegen Wegrutschen sichern.</li> </ul>
	<p style="text-align: center;"><b>⚠️ VORSICHT</b></p> <p><b>Risiko herabfallender Teile durch gelöste Schrauben!</b> Verletzungsgefahr durch herabfallende Teile.</p> <ul style="list-style-type: none"> <li>▶ Die Komponenten gegen Herunterfallen sichern.</li> </ul>
	<p style="text-align: center;"><b>⚠️ ACHTUNG</b></p> <p><b>Risiko herabfallender Teile durch gelöste Schrauben!</b> Gefahr der Beschädigung anderer Geräteteile bzw. von Beschädigungen im Haushalt des Kunden, z. B. des Bodens.</p> <ul style="list-style-type: none"> <li>▶ Die Komponenten gegen Herunterfallen sichern.</li> </ul>

### Voraussetzung:

- ✅ Das Gerät ist spannungsfrei.
- ✅ Die Innenausstattungsteile des Geräts sind entfernt.
- ✅ Das Gerät ist auf der Rückseite abgelegt.

✅ [Das obere Scharnier ist entfernt. → Seite 218](#)

### 4.6.1 Austauschen des unteren Türscharniers

1. Die Tür entfernen.

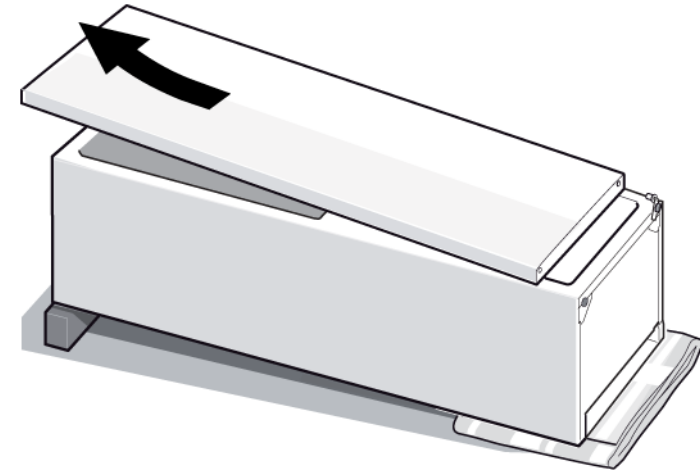

2.
  1. Die Schraube herausschrauben (1).
  2. Das untere Scharnier nach außen drehen (2).
  3. Das untere Scharnier entfernen (3).

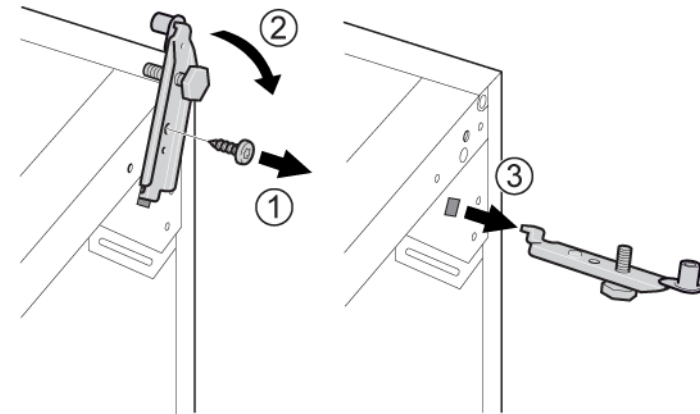

➡ Das untere Scharnier ist entfernt.

## 4.6.2 Einbauen des unteren Türscharniers

- ▶ Der Einbau erfolgt in umgekehrter Reihenfolge.

## 4.7 Austauschen der Ablage

### Voraussetzung:

- ✔ Die Tür ist offen.

### 4.7.1 Ausbauen der Ablage

- ▶ Die Ablage herausziehen.

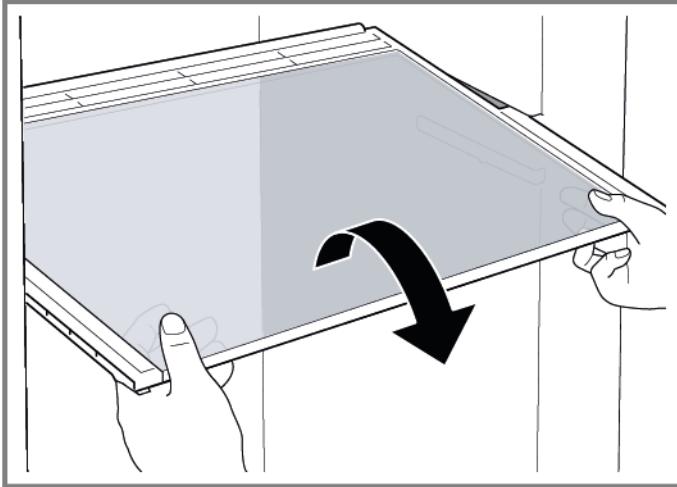

- ➡ Die Ablage ist entfernt.

### 4.7.2 Einbauen der Ablage

- ▶ Der Einbau erfolgt in umgekehrter Reihenfolge.

## 4.8 Austauschen des Gefriergutbehälters

### Voraussetzung:

- ✔ Die Tür ist offen.

### 4.8.1 Ausbauen des Gefriergutbehälters

- ▶ 1. Den Gefriergutbehälter vollständig herausziehen (1).
- ▶ 2. Den Gefriergutbehälter entfernen (2).

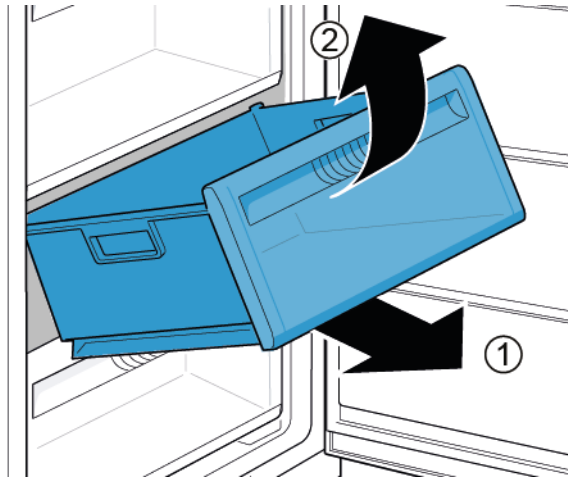

- ➡ Der Gefriergutbehälter ist entfernt.

### 4.8.2 Einbauen des Gefriergutbehälters

- ▶ Der Einbau erfolgt in umgekehrter Reihenfolge.



## 4.9 Austauschen des Eisbereiters

### Voraussetzung:

- ✔ Die Tür ist offen.

### 4.9.1 Ausbauen des Eisbereiters

- ▶ 1. Die Ablage mit dem Gefriergutbehälter und dem Eisbereiter herausziehen (1).
- ▶ 2. Die Haken lösen (2).
- ▶ 3. Den Eisbereiter entfernen (3).

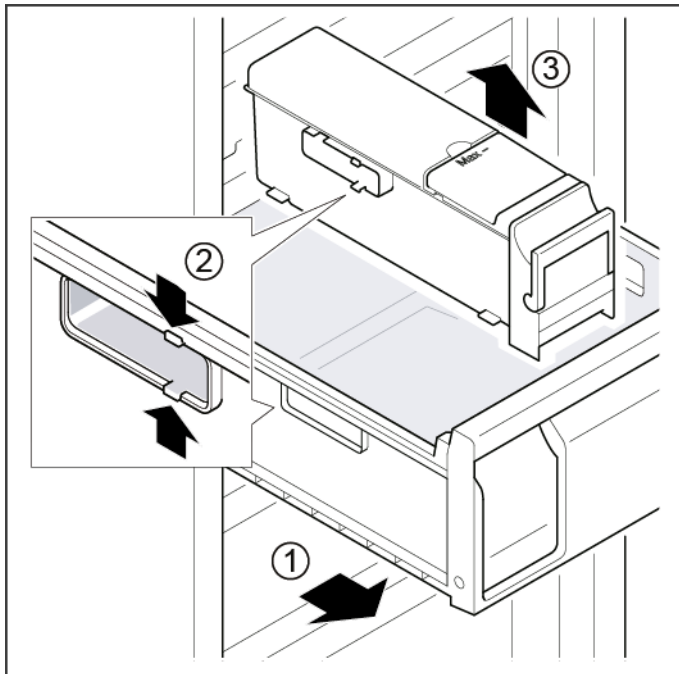

➡ Der Eisbereiter ist entfernt.

### 4.9.2 Einbauen des Eisbereiters

- ▶ Der Einbau erfolgt in umgekehrter Reihenfolge.

## 4.10 Austauschen des LED-Oberlichts

### Spezielle Hilfsmittel:

-  Schlitzschraubendreher Klinge 2,4 mm x 0,4 mm x 60 mm, im Set [00341820]



	Ihr Gerät ist mit einer wartungsfreien LED-Beleuchtung ausgestattet. Reparaturen an dieser Beleuchtung dürfen nur vom Kundendienst oder von autorisierten Fachkräften ausgeführt werden!
---	--

	<b>⚠ GEFAHR</b>
	<b>Stromschlaggefahr durch spannungsführende Teile!</b> Lebensgefahr durch Stromschlag bei unsachgemäßer Reparatur <ul style="list-style-type: none"> <li>▶ Elektroteile sollten von eine Elektrofachkraft repariert werden.</li> <li>▶ Nach der Reparatur muss eine Sicherheitsprüfung nach VDE 0701 oder länderspezifischen Vorschriften durchgeführt werden.</li> </ul>

	<b>⚠ GEFAHR</b>
	<b>Stromschlaggefahr durch spannungsführende Teile!</b> Tod durch Stromschlag <ul style="list-style-type: none"> <li>▶ Gerät mindestens 60 Sekunden vor Reparaturbeginn vom Netz trennen.</li> </ul>

	<b>⚠ VORSICHT</b>
	<b>Scharfe Kanten!</b> Schnittverletzungen <ul style="list-style-type: none"> <li>▶ Schutzhandschuhe tragen.</li> </ul>

### Voraussetzung:

-  Das Gerät ist spannungsfrei.
-  Die Tür ist offen.
-  Die oberen Innenausstattungsteile sind entfernt.

### 4.10.1 Ausbauen der LED-Beleuchtung

1. Die LED-Beleuchtung nach links schieben.

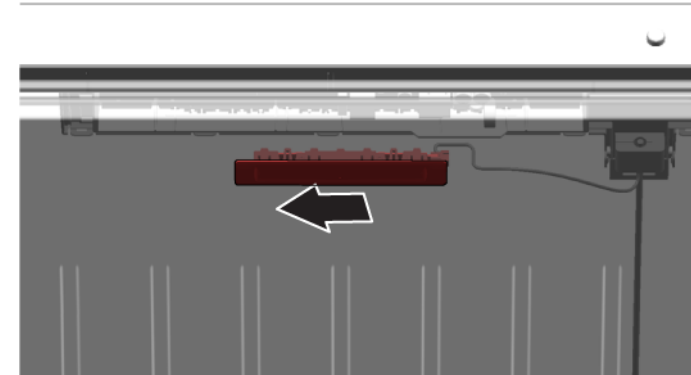

-  Der elektrische Anschluss der LED-Beleuchtung ist getrennt.

2. Die Haken der LED-Beleuchtung lösen.

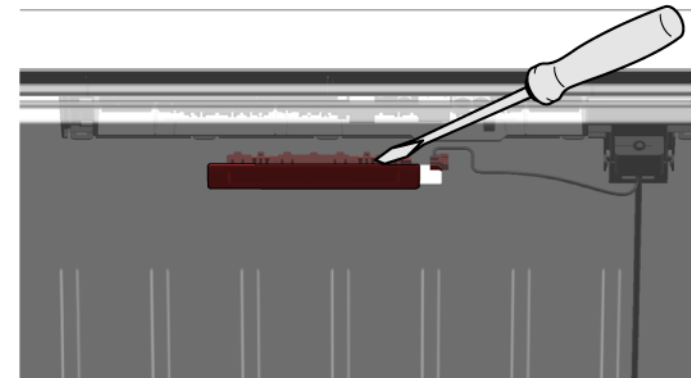

3. Die LED-Beleuchtung nach vorn entnehmen.

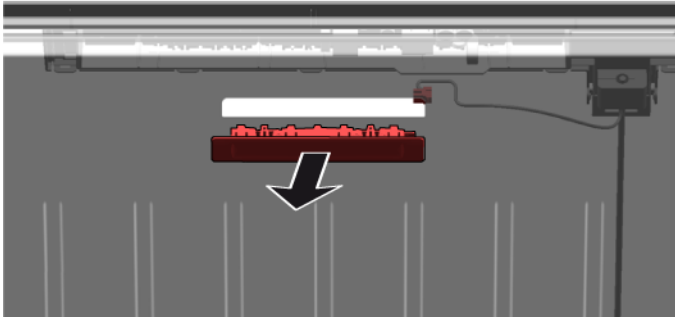

- ➡ Die LED-Beleuchtung ist entfernt.

### 4.10.2 Einbauen des LED-Oberlichts

- ▶ Der Einbau erfolgt in umgekehrter Reihenfolge.

# Υποδείξεις επισκευής - Καταψύκτης

## Σχετικά με αυτό το έγγραφο..... 229

- 1.1 Σημαντικές πληροφορίες ..... 229
  - 1.1.1 Σκοπός..... 229
- 1.2 Επεξήγηση συμβόλων ..... 229
  - 1.2.1 Επίπεδα κινδύνου ..... 229
  - 1.2.2 Σύμβολα κινδύνου..... 229
  - 1.2.3 Δομή των προειδοποιήσεων ..... 230
  - 1.2.4 Γενικά σύμβολα ..... 230

## Ασφάλεια..... 231

- 2.1 Γενικές οδηγίες ασφαλείας ..... 231
  - 2.1.1 Όλες οι οικιακές συσκευές ..... 231

## Εργαλεία και βοηθήματα ..... 232

## Επισκευή ..... 233

- 4.1 Αντικατάσταση στεγανοποιητικού πόρτας ..... 233
  - 4.1.1 Αφαίρεση στεγανοποιητικού πόρτας..... 233
  - 4.1.2 Τοποθέτηση στεγανοποιητικού πόρτας ..... 233
- 4.2 Αντικατάσταση λαβής πόρτας..... 236
  - 4.2.1 Αφαίρεση λαβής πόρτας..... 236
  - 4.2.2 Τοποθέτηση λαβής πόρτας..... 236
- 4.3 Αντικατάσταση λαβής easy open (ευκολία ανοίγματος) ..... 237
  - 4.3.1 Αφαίρεση λαβής easy open ..... 237
  - 4.3.2 Τοποθέτηση λαβής easy open ..... 237
- 4.4 Αντικατάσταση επάνω μεντεσέ πόρτας ..... 239
  - 4.4.1 Αφαίρεση μεντεσέ πόρτας ..... 239
  - 4.4.2 Τοποθέτηση μεντεσέ πόρτας ..... 241
- 4.5 Αντικατάσταση επάνω μεντεσέ πόρτας (πόρτα με οθόνη) ..... 242
  - 4.5.1 Αφαίρεση μεντεσέ πόρτας ..... 243
  - 4.5.2 Τοποθέτηση μεντεσέ πόρτας ..... 244
- 4.6 Αντικατάσταση κάτω μεντεσέ πόρτας..... 245
  - 4.6.1 Αντικατάσταση κάτω μεντεσέ πόρτας ..... 245
  - 4.6.2 Τοποθέτηση κάτω μεντεσέ πόρτας..... 245
- 4.7 Αντικατάσταση ραφιού ..... 246
  - 4.7.1 Αφαίρεση ραφιού ..... 246
  - 4.7.2 Τοποθέτηση ραφιού ..... 246

- 4.8 Αντικατάσταση συρταριού κατεψυγμένων τροφίμων..... 247
  - 4.8.1 Αφαίρεση συρταριού κατεψυγμένων τροφίμων ..... 247
  - 4.8.2 Τοποθέτηση συρταριού κατεψυγμένων τροφίμων ..... 247
- 4.9 Αντικατάσταση παρασκευαστή πάγου ..... 248
  - 4.9.1 Αφαίρεση παρασκευαστή πάγου ..... 248
  - 4.9.2 Τοποθέτηση παρασκευαστή πάγου ..... 248
- 4.10 Αντικατάσταση επάνω φωτός LED ..... 249
  - 4.10.1 Αφαίρεση φωτός LED ..... 249
  - 4.10.2 Τοποθέτηση επάνω φωτισμού LED ..... 250

# **i** Σχετικά με αυτό το έγγραφο

## 1.1 Σημαντικές πληροφορίες

### 1.1.1 Σκοπός

Αυτές οι συμβουλές επισκευών υποστηρίζουν τους καταναλωτές στην επισκευή των συσκευών από τους ίδιους, σύμφωνα με τον ισχύοντα κανονισμό οικολογικού σχεδιασμού (από τις 03/2021).





Περιέχουν πληροφορίες για την αντικατάσταση ορισμένων ανταλλακτικών, συμπεριλαμβανομένων προειδοποιήσεων και κινδύνων.

Σε περίπτωση ερωτήσεων, επικοινωνήστε με το τμήμα εξυπηρέτησης πελατών της εταιρείας μας. Φέρουμε ευθύνη για τις ζημιές εάν οι συμβουλές επισκευής έχουν ακολουθηθεί σωστά.

## 1.2 Επεξήγηση συμβόλων

### 1.2.1 Επίπεδα κινδύνου

Τα επίπεδα προειδοποίησης ασφάλειας αποτελούνται από ένα σύμβολο και μια λέξη. Η λέξη προειδοποίησης προσδιορίζει τη σοβαρότητα του κινδύνου.





Επίπεδο προειδοποίησης	Σημασία
 <b>ΚΙΝΔΥΝΟΣ</b>	Η μη τήρηση του προειδοποιητικού μηνύματος θα οδηγήσει σε θάνατο ή σε σοβαρούς τραυματισμούς.
 <b>ΠΡΟΕΙΔΟΠΟΙΗΣΗ</b>	Η μη τήρηση του προειδοποιητικού μηνύματος θα μπορούσε να οδηγήσει σε θάνατο ή σε σοβαρούς τραυματισμούς.
 <b>ΠΡΟΣΟΧΗ</b>	Η μη τήρηση του προειδοποιητικού μηνύματος θα μπορούσε να οδηγήσει σε μικρούς τραυματισμούς.
 <b>ΠΡΟΣΟΧΗ!</b>	Η μη τήρηση του προειδοποιητικού μηνύματος θα μπορούσε να οδηγήσει σε υλικές ζημιές της ιδιοκτησίας.

Πίνακας 1: Επίπεδα κινδύνου





### 1.2.2 Σύμβολα κινδύνου

Τα σύμβολα κινδύνου είναι συμβολικές αναπαραστάσεις που δίνουν μια ένδειξη για το είδος του κινδύνου.

Τα ακόλουθα σύμβολα κινδύνου χρησιμοποιούνται στο παρόν έγγραφο:

Σύμβολο κινδύνου	Σημασία
	Γενικό προειδοποιητικό μήνυμα
	Κίνδυνος από ηλεκτρική τάση
	Κίνδυνος έκρηξης
	Κίνδυνος κοψίματος

## **i** Σχετικά με αυτό το έγγραφο

Σύμβολο κινδύνου	Σημασία
	Κίνδυνος σύνθλιψης
	Κίνδυνος από καυτές επιφάνειες
	Κίνδυνος από ισχυρό μαγνητικό πεδίο
	Κίνδυνος από μη ιονίζουσα ακτινοβολία

Πίνακας 2: Σύμβολα κινδύνου

### 1.2.3 Δομή των προειδοποιήσεων

.Οι προειδοποιήσεις σε αυτό το έγγραφο έχουν μια τυποποιημένη εμφάνιση και μια τυποποιημένη δομή.









	<b>⚠ ΚΙΝΔΥΝΟΣ</b>
<b>Είδος και πηγή κινδύνου!</b>	
Πιθανές συνέπειες εάν αγνοήσετε τον κίνδυνο/την προειδοποίηση.	
▶ Μέτρα και απαγορεύσεις για την πρόληψη του κινδύνου.	

Το παρακάτω παράδειγμα δείχνει μια προειδοποίηση που προειδοποιεί κατά της ηλεκτροπληξίας λόγω ηλεκτροφόρων μερών. Αναφέρεται το μέτρο για την αποφυγή του κινδύνου.

	<b>⚠ ΚΙΝΔΥΝΟΣ</b>
<b>Κίνδυνος ηλεκτροπληξίας λόγω ηλεκτροφόρων μερών!</b>	
Θάνατος από ηλεκτροπληξία	
▶ Αποσυνδέετε τις συσκευές από την παροχή ηλεκτρικού ρεύματος τουλάχιστον 60 δευτερόλεπτα πριν ξεκινήσετε τις επισκευές.	

### 1.2.4 Γενικά σύμβολα

Τα ακόλουθα γενικά σύμβολα χρησιμοποιούνται στο παρόν έγγραφο:

Γεν. σύμβολο	Σημασία
	Ταυτοποίηση μιας ειδικής συμβουλής (κειμένου ή/και γραφικών)
	Ταυτοποίηση μιας ειδικής συμβουλής (μόνο κειμένου)
	Ταυτοποίηση συνδέσμου ή εκπαιδευτικού βίντεο
	Ταυτοποίηση απαραίτητων εργαλείων
	Ταυτοποίηση απαραίτητων προϋποθέσεων
	Ταυτοποίηση μιας συνθήκης (αν ..., κατόπιν ...)
	Ταυτοποίηση αποτελέσματος
	Ταυτοποίηση ενός πλήκτρου ή κουμπιού
[00123456]	Ταυτοποίηση ενός κωδικού ανταλλακτικού
Κατάσταση	Ταυτοποίηση εμφανιζόμενου κειμένου/ παραθύρου (στην οθόνη της συσκευής)

Πίνακας 3: Γενικά σύμβολα

## 2.1 Γενικές οδηγίες ασφαλείας

### 2.1.1 Όλες οι οικιακές συσκευές

#### **Κίνδυνος ηλεκτροπληξίας λόγω ηλεκτροφόρων μερών!**

- Τα σφάλματα από επισκευές σε ηλεκτρικά εξαρτήματα μπορεί να προκαλέσουν ηλεκτροπληξία!
- Αποσυνδέστε τη συσκευή από την πρίζα για τουλάχιστον 60 δευτερόλεπτα πριν από την έναρξη των εργασιών.
- Μετά την επισκευή πραγματοποιήστε έλεγχο ασφαλείας σύμφωνα με το VDE 0701 ή κανονισμούς της συγκεκριμένης χώρας.

#### **Κίνδυνος τραυματισμού από κοφτερές άκρες!**

- Φοράτε προστατευτικά γάντια.

#### **Κίνδυνος σύνθλιψης κατά την επισκευή, συντήρηση, αντιμετώπιση προβλημάτων και το σέρβις από βαριά και κινούμενα μέρη**

- Φοράτε προστατευτικά υποδήματα.
- Ασφαλίστε τα βαριά μέρη από πτώση.
- Μην προσαρτάτε μέρη του πλαισίου στα κινούμενα μέρη.



#### **Κίνδυνος για την ασφάλεια/τη λειτουργία της συσκευής!**

- Χρησιμοποιείτε μόνο γνήσια ανταλλακτικά.

#### **Κίνδυνος πρόκλησης βλάβης σε μέρη ευαίσθητα στον στατικό ηλεκτρισμό (ESDs)!**

- Μην αγγίζετε τις μονάδες, συμπεριλαμβανομένων των συνδέσεων και των αγωγών των πλακετών.

## Εργαλεία και βοηθήματα

Όνομασία	Λεπτομέριες	Εικόνες
Πανάκι προστασίας [00342013]	60 cm x 50 cm	
Κατσαβίδι Phillips PH2		
Μύτη Torx TX20 [00340865]	6,3 mm (1/4")	
Πλακέ κατσαβίδι	Λεπίδα 2,4 mm x 0,4 mm x 60 mm, στο κιτ [00341820]	



## 4.1 Αντικατάσταση στεγανοποιητικού πόρτας

### Προϋπόθεση:

- ✔ Η πόρτα είναι ανοιχτή.

### 4.1.1 Αφαίρεση στεγανοποιητικού πόρτας

1. Απελευθερώστε το στεγανοποιητικό πόρτας από την εγκοπή στη δεξιά και αριστερή γωνία.

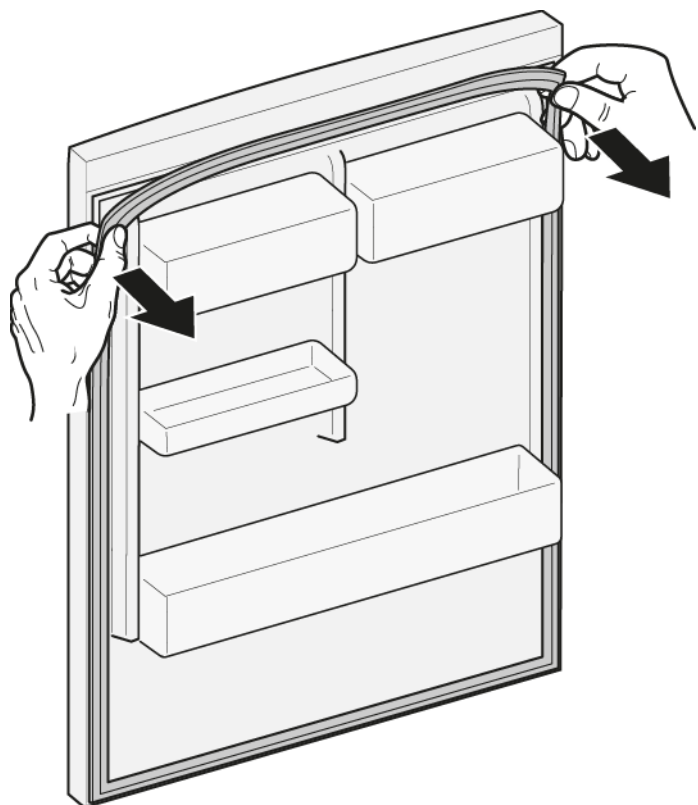



2. Τραβήξτε το στεγανοποιητικό πόρτας έξω από την εγκοπή.



- ➡ Το στεγανοποιητικό της πόρτας έχει αφαιρεθεί.

### 4.1.2 Τοποθέτηση στεγανοποιητικού πόρτας

	Το πάχος του νέου στεγανοποιητικού πόρτας μπορεί να αποκλίνει ελαφρώς από το πάχος του παλαιού στεγανοποιητικού πόρτας. Αυτό δεν θα επηρεάσει τη συμπεριφορά κλεισίματος και τη μακροπρόθεσμη λειτουργία.
	Εάν η συσκευή σας έχει προσαρμοζόμενους μεντεσέδες ή προσαρτήματα μεντεσέ, μπορεί να βελτιστοποιήσετε τη συμπεριφορά κλεισίματος αργότερα.
	Οι μικρές οπές πλευρικά στο στεγανοποιητικό της πόρτας είναι λειτουργικές (απαραίτητες για τον αερισμό). Δεν είναι κατασκευαστικά ελαττώματα.

1. Ελέγξτε την εγκοπή για το στεγανοποιητικό για ζημιές.

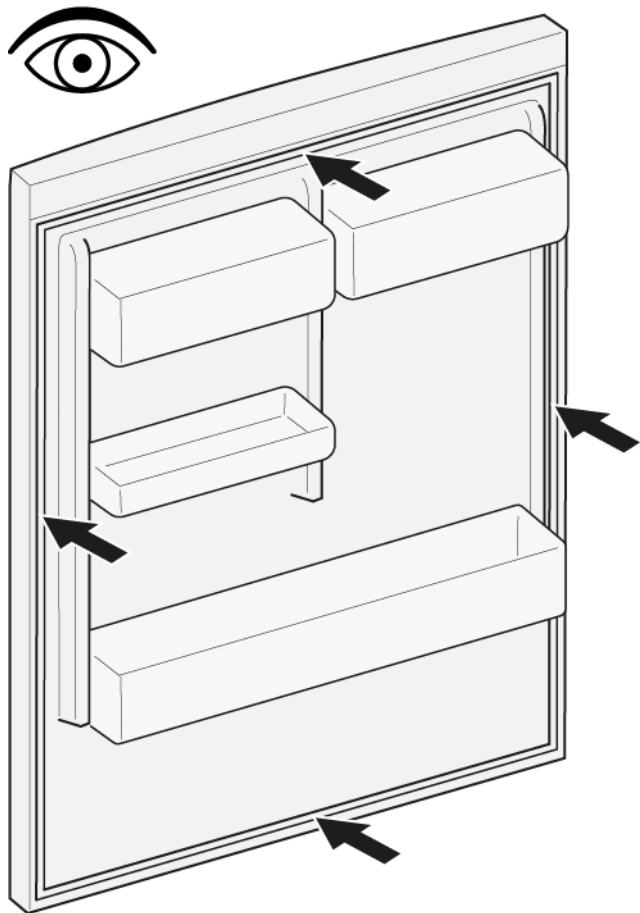

4. Πιέστε τις γωνίες του στεγανοποιητικού επάνω και κάτω στην εγκοπή.

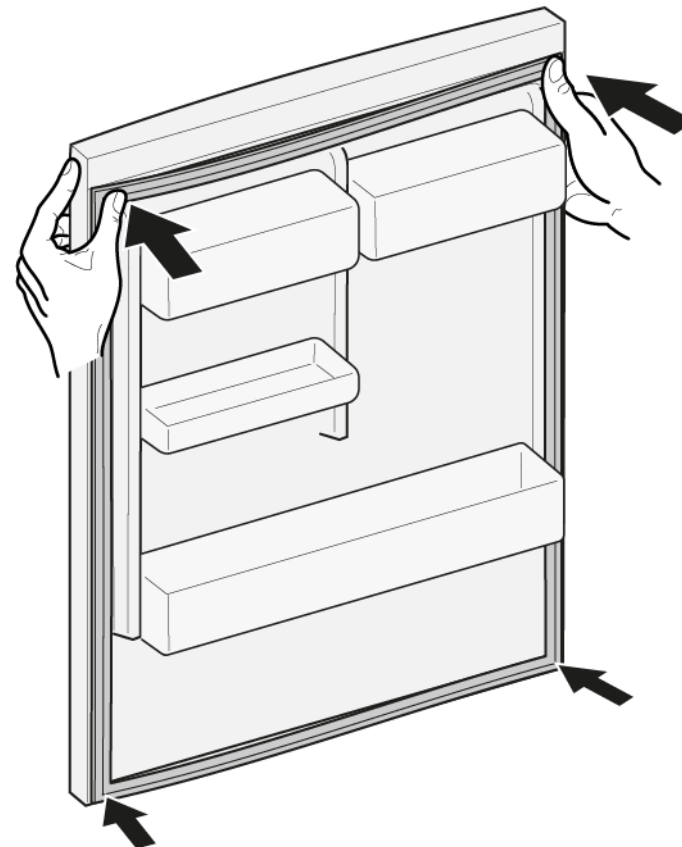



2. ⓘ Εάν η εγκοπή για στεγανοποιητικό είναι κατεστραμμένη.  
- Επικοινωνήστε με την εξυπηρέτηση πελατών.

3. ⓘ Η ελαφριά παραμόρφωση του στεγανοποιητικού της πόρτας είναι φυσιολογική και δεν επηρεάζει τη λειτουργία της. Συνιστάται να ισιώνετε το στεγανοποιητικό της πόρτας πριν την τοποθετήσετε στη συσκευή.

Θερμάνετε το στεγανοποιητικό της πόρτας με πιστολάκι ή ζεστό νερό και αλλάξτε το σχήμα του με το χέρι.

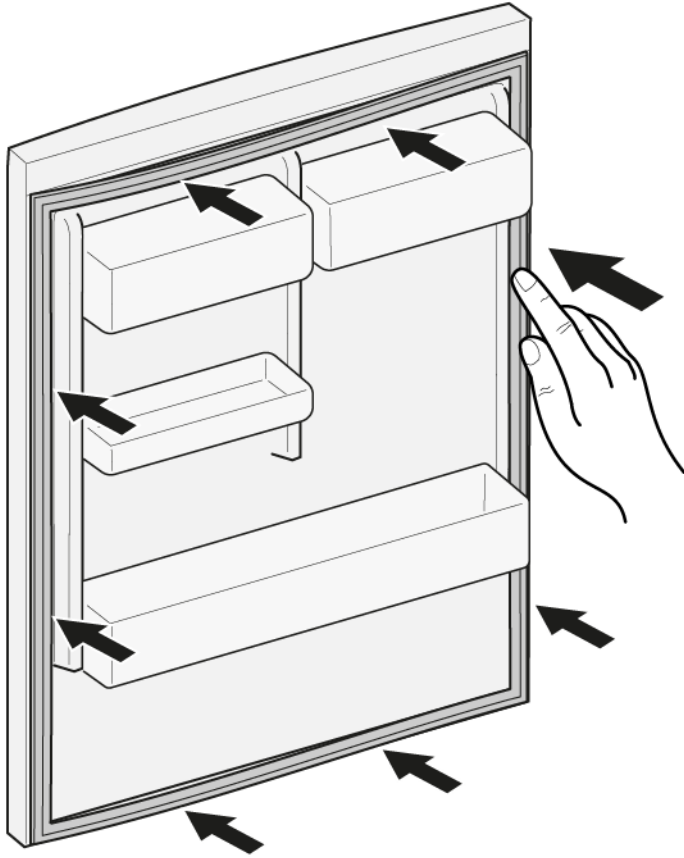
5. Πιέστε ολόκληρο το στεγανοποιητικό βήμα βήμα στο εσωτερικό της εγκοπής.



-  Το στεγανοποιητικό της πόρτας τοποθετήθηκε.

## 4.2 Αντικατάσταση λαβής πόρτας

Ειδικά βοηθητικά μέσα:

- |                   |                                |            |
|-------------------|--------------------------------|------------|
| 🔧 Μύτη Torx TX20  | 6,3 mm (1/4")                  | [00340865] |
| 🔧 Πλακέ κατσαβίδι | Λεπίδα 10 mm x 1,6 mm x 200 mm |            |

Προϋπόθεση:

- ✔ Η συσκευή είναι αποσυνδεδεμένη από την παροχή τροφοδοσίας.
- ✔ Η πόρτα είναι ανοιχτή.

### 4.2.1 Αφαίρεση λαβής πόρτας

- ▶ 1. Αφαιρέστε τα δύο πώματα βίδας (1).
- ▶ 2. Ξεβιδώστε δύο βίδες (2).
- ▶ 3. Αφαιρέστε τη λαβή της πόρτας (3).

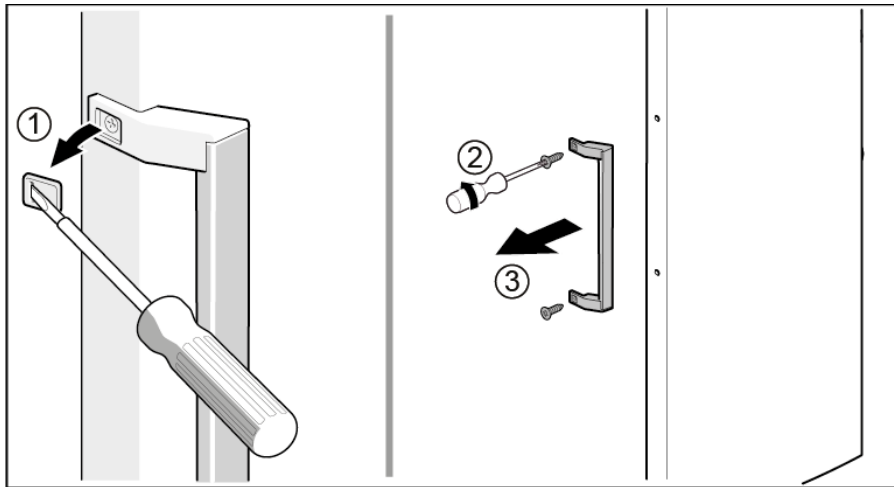

➡ Η λαβή της πόρτας έχει αφαιρεθεί.

### 4.2.2 Τοποθέτηση λαβής πόρτας



- ▶ Εγκαταστήστε με την αντίθετη σειρά.

### 4.3 Αντικατάσταση λαβής easy open (ευκολία ανοίγματος)

Ειδικά βοηθητικά μέσα:

-  Κατσαβίδι Phillips PH2

Προϋπόθεση:

-  Η συσκευή είναι αποσυνδεδεμένη από την παροχή τροφοδοσίας.
-  Η πόρτα είναι ανοιχτή.

#### 4.3.1 Αφαίρεση λαβής easy open

1. Αφαιρέστε το κάλυμμα της λαβής easy open (1).
2. Ξεβιδώστε δύο βίδες (2).

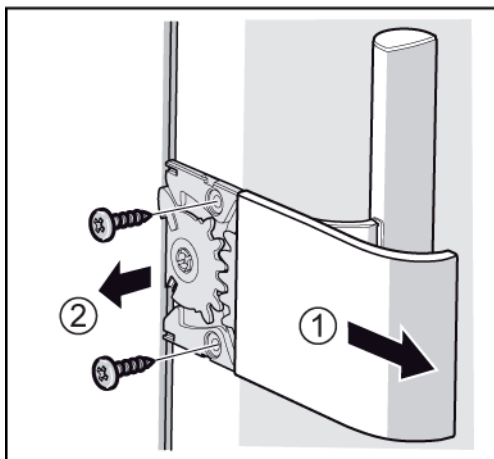

 Η λαβή easy open έχει αφαιρεθεί.

#### 4.3.2 Τοποθέτηση λαβής easy open

Ο μηχανισμός λαβής easy open πρέπει να έχει ρυθμιστεί σωστά πριν από την εγκατάσταση.  
Η σωστή τοποθέτηση της ωστήριας ράβδου (1), των οδοντωτών τμημάτων (2) και (3), του ελατηρίου (4) και του τερματικού στοπ (5) για την τοποθέτηση στην αριστερή πλευρά της πόρτας εμφανίζεται στην εικόνα.

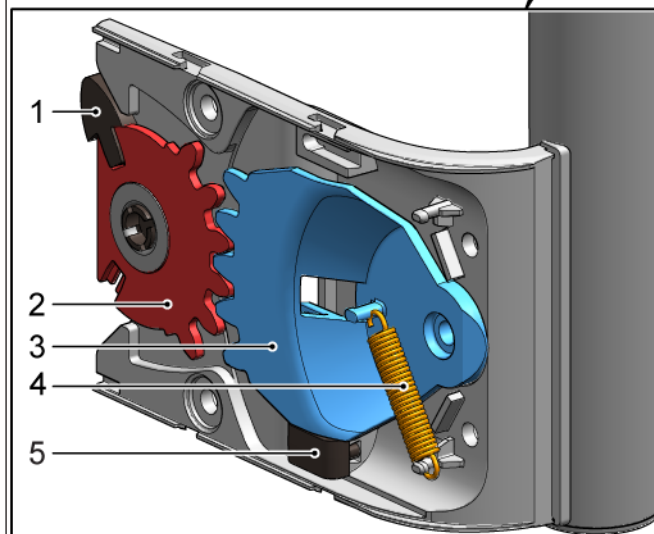
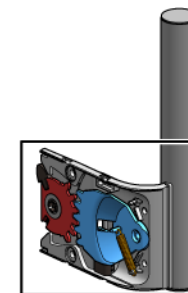

Η τοποθέτηση των επιμέρους στοιχείων της λαβής easy open για την τοποθέτηση στη δεξιά πλευρά της πόρτας περιγράφεται στο έγγραφο "Οδηγίες συναρμολόγησης".

- ▶ Εγκαταστήστε με την αντίθετη σειρά.

#### 4.4 Αντικατάσταση επάνω μεντεσέ πόρτας

Ειδικά βοηθητικά μέσα:

 Μύτη Torx TX20                      6,3 mm (1/4")                      [00340865]

	<b>⚠ ΠΡΟΕΙΔΟΠΟΙΗΣΗ</b> <b>Βαριές, ογκώδεις συσκευές!</b> Τραυματισμοί μέσης και μυών <ul style="list-style-type: none"><li>▶ Η διαδικασία αφαίρεσης της πόρτας της συσκευής πρέπει να εκτελείται μόνο από εκπαιδευμένους ειδικούς.</li><li>▶ Η μετακίνηση της συσκευής πρέπει να εκτελείται από δύο άτομα.</li><li>▶ Χρησιμοποιείτε μόνο κατάλληλα εργαλεία και εξοπλισμό.</li></ul>
--	--

	<b>⚠ ΠΡΟΣΟΧΗ</b> <b>Αιχμηρές ακμές!</b> Τραυματισμοί από κοπή <ul style="list-style-type: none"><li>▶ Φοράτε προστατευτικά γάντια.</li></ul>
--	--

	<b>⚠ ΠΡΟΕΙΔΟΠΟΙΗΣΗ</b> <b>Ολίσθηση κεκλιμένων συσκευών!</b> Κατάγματα οστών/τραυματισμοί σύνθλιψης <ul style="list-style-type: none"><li>▶ Ασφαλίστε τις συσκευές από ολίσθηση.</li></ul>
--	---

	<b>⚠ ΠΡΟΣΟΧΗ</b> <b>Κίνδυνοι από πτώση μερών εξαιτίας χαλαρών βιδών!</b> Τραυματισμός εξαιτίας πτώσης τμημάτων. <ul style="list-style-type: none"><li>▶ Ασφαλίστε τα εξαρτήματα από πτώση.</li></ul>
---	--

	<b>ΠΡΟΣΟΧΗ!</b> <b>Κίνδυνων από πτώση εξαρτημάτων εξαιτίας χαλαρών βιδών!</b> Ζημιά σε άλλα μέρη της συσκευής ή στην οικία του πελάτη, π.χ. δάπεδο. <ul style="list-style-type: none"><li>▶ Ασφαλίστε τα εξαρτήματα από πτώση.</li></ul>
--	--

Προϋπόθεση:

- ✔ Η συσκευή είναι αποσυνδεδεμένη από την παροχή τροφοδοσίας.
- ✔ Αφαιρούνται τα εσωτερικά εξαρτήματα συσκευής.

#### 4.4.1 Αφαίρεση μεντεσέ πόρτας

1. Τοποθετήστε τη συσκευή στην πίσω πλευρά.

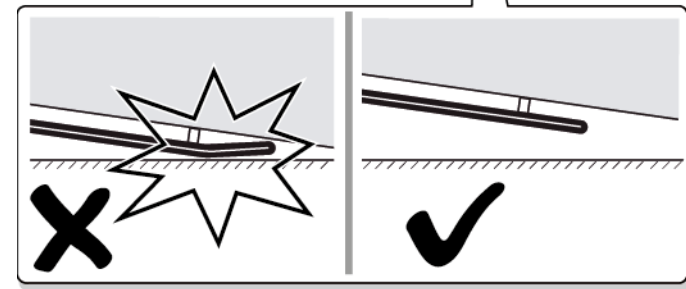
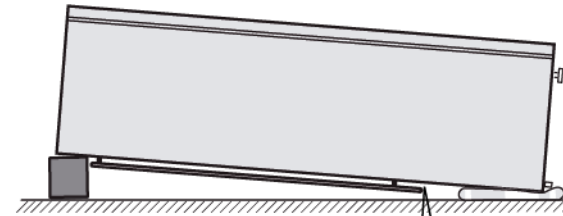
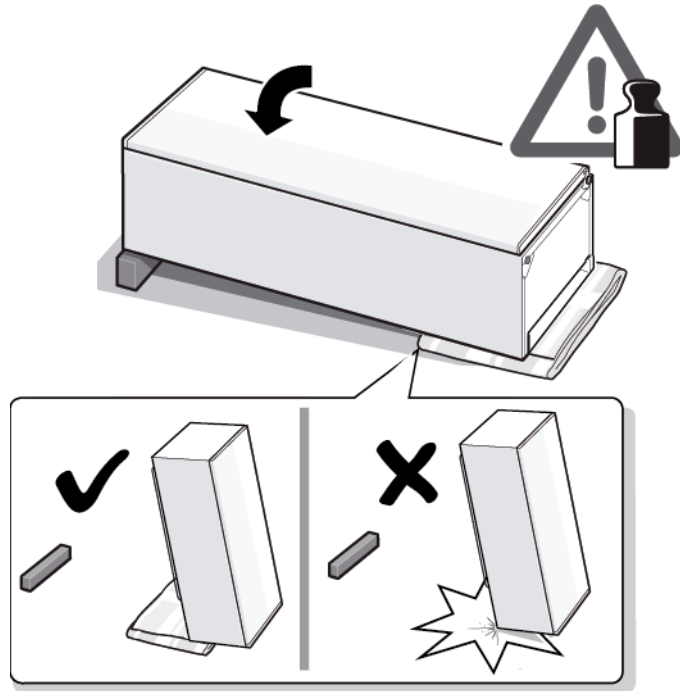

1. Πιέστε το επάνω κάλυμμα μεντεσέ και στις δύο πλευρές (1).
2. Μετακινήστε και αφαιρέστε το κάλυμμα επάνω μεντεσέ (2).
3. Αφαιρέστε το κάλυμμα επάνω μεντεσέ (3).

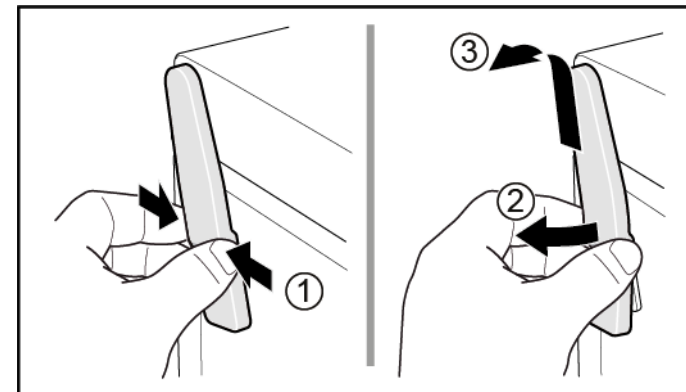



## ΕΠΙΣΚΕΥΗ

3. 1. Ξεβιδώστε δύο βίδες (1).
2. Αφαιρέστε τον επάνω μεντεσέ (2).

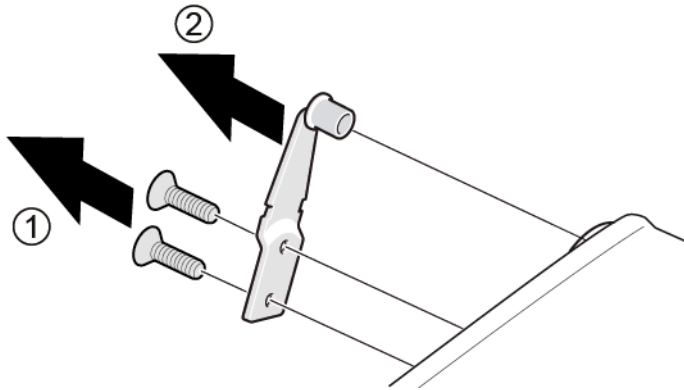

 Ο επάνω μεντεσές έχει αφαιρεθεί.

### 4.4.2 Τοποθέτηση μεντεσέ πόρτας

- ▶ Εγκαταστήστε με την αντίθετη σειρά.

## 4.5 Αντικατάσταση επάνω μεντεσέ πόρτας (πόρτα με θόνη)

Ειδικά βοηθητικά μέσα:

 Μύτη Torx TX20      6,3 mm (1/4")      [00340865]

	<b>⚠ ΠΡΟΕΙΔΟΠΟΙΗΣΗ</b>
	<p><b>Βαριές, ογκώδεις συσκευές!</b> Τραυματισμοί μέσης και μυών</p> <ul style="list-style-type: none"> <li>▶ Η διαδικασία αφαίρεσης της πόρτας της συσκευής πρέπει να εκτελείται μόνο από εκπαιδευμένους ειδικούς.</li> <li>▶ Η μετακίνηση της συσκευής πρέπει να εκτελείται από δύο άτομα.</li> <li>▶ Χρησιμοποιείτε μόνο κατάλληλα εργαλεία και εξοπλισμό.</li> </ul>

	<b>⚠ ΠΡΟΣΟΧΗ</b>
	<p><b>Αιχμηρές ακμές!</b> Τραυματισμοί από κοπή</p> <ul style="list-style-type: none"> <li>▶ Φοράτε προστατευτικά γάντια.</li> </ul>

	<b>⚠ ΠΡΟΕΙΔΟΠΟΙΗΣΗ</b>
	<p><b>Ολίσθηση κεκλιμένων συσκευών!</b> Κατάγματα οστών/τραυματισμοί σύνθλιψης</p> <ul style="list-style-type: none"> <li>▶ Ασφαλίστε τις συσκευές από ολίσθηση.</li> </ul>



	<b>⚠ ΠΡΟΣΟΧΗ</b>
	<p><b>Κίνδυνοι από πτώση μερών εξαιτίας χαλαρών βιδών!</b> Τραυματισμός εξαιτίας πτώσης τμημάτων.</p> <ul style="list-style-type: none"> <li>▶ Ασφαλίστε τα εξαρτήματα από πτώση.</li> </ul>

	<b>ΠΡΟΣΟΧΗ!</b>
	<p><b>Κίνδυνων από πτώση εξαρτημάτων εξαιτίας χαλαρών βιδών!</b> Ζημιά σε άλλα μέρη της συσκευής ή στην οικία του πελάτη, π.χ. δάπεδο.</p> <ul style="list-style-type: none"> <li>▶ Ασφαλίστε τα εξαρτήματα από πτώση.</li> </ul>

	<b>⚠ ΚΙΝΔΥΝΟΣ</b>
	<p><b>Κίνδυνος ηλεκτροπληξίας λόγω ηλεκτροφόρων μερών!</b> Κίνδυνος για τη ζωή από ηλεκτροπληξία σε περίπτωση ακατάλληλης επισκευής</p> <ul style="list-style-type: none"> <li>▶ Τα ηλεκτρικά μέρη πρέπει να επισκευάζονται από εκπαιδευμένους ηλεκτρολόγους.</li> <li>▶ Μετά την επισκευή πραγματοποιήστε έλεγχο ασφάλειας σύμφωνα με το VDE 0701 ή κανονισμούς της συγκεκριμένης χώρας.</li> </ul>

	<b>⚠ ΚΙΝΔΥΝΟΣ</b>
	<p><b>Κίνδυνος ηλεκτροπληξίας λόγω ηλεκτροφόρων μερών!</b> Θάνατος από ηλεκτροπληξία</p> <ul style="list-style-type: none"> <li>▶ Αποσυνδέετε τις συσκευές από την παροχή ηλεκτρικού ρεύματος τουλάχιστον 60 δευτερόλεπτα πριν ξεκινήσετε τις επισκευές.</li> </ul>

**Προϋπόθεση:**

-  Η συσκευή είναι αποσυνδεδεμένη από την παροχή τροφοδοσίας.
-  Αφαιρούνται τα εσωτερικά εξαρτήματα συσκευής.

#### 4.5.1 Αφαίρεση μεντεσέ πόρτας

1. Τοποθετήστε τη συσκευή στην πίσω πλευρά.

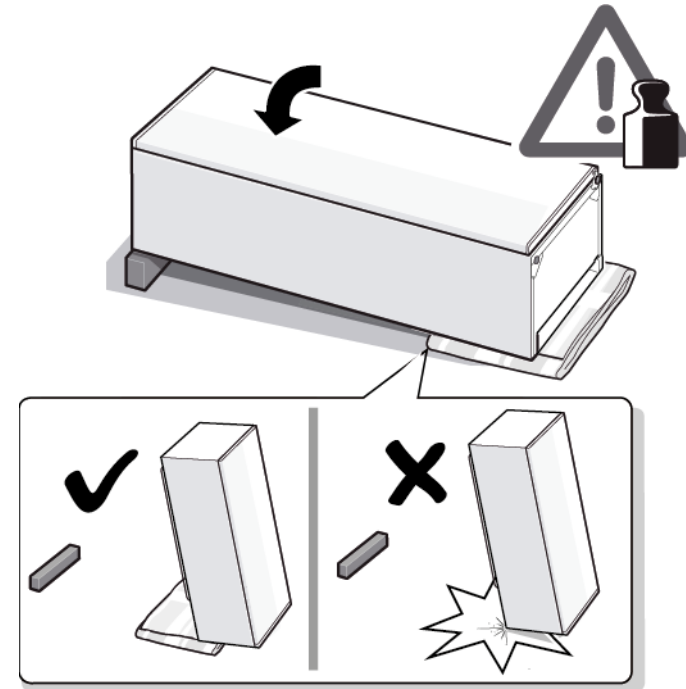

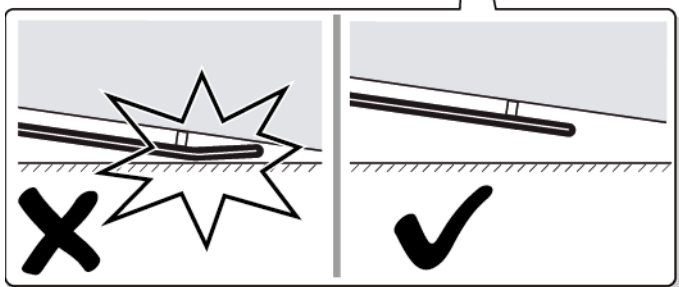
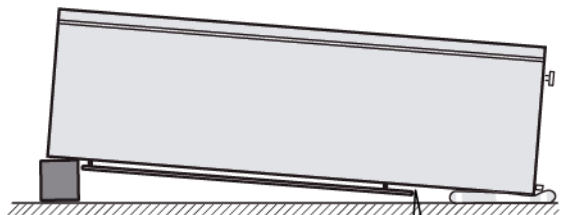

1. Πιέστε το επάνω κάλυμμα μεντεσέ και στις δύο πλευρές (1).
2. Μετακινήστε και αφαιρέστε το κάλυμμα επάνω μεντεσέ (2).
3. Αφαιρέστε το κάλυμμα επάνω μεντεσέ (3).

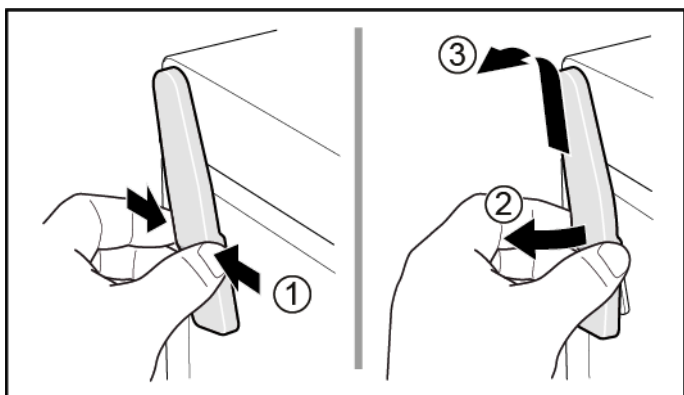

1. Αφαιρέστε το κάλυμμα του κουτιού καλωδίων (1).
2. Αφαιρέστε την προστασία καλωδίων (2).
3. Αποσυνδέστε την ηλεκτρική σύνδεση (3).
4. Ξεβιδώστε δύο βίδες (4).
5. Αφαιρέστε τον επάνω μεντεσέ (5).

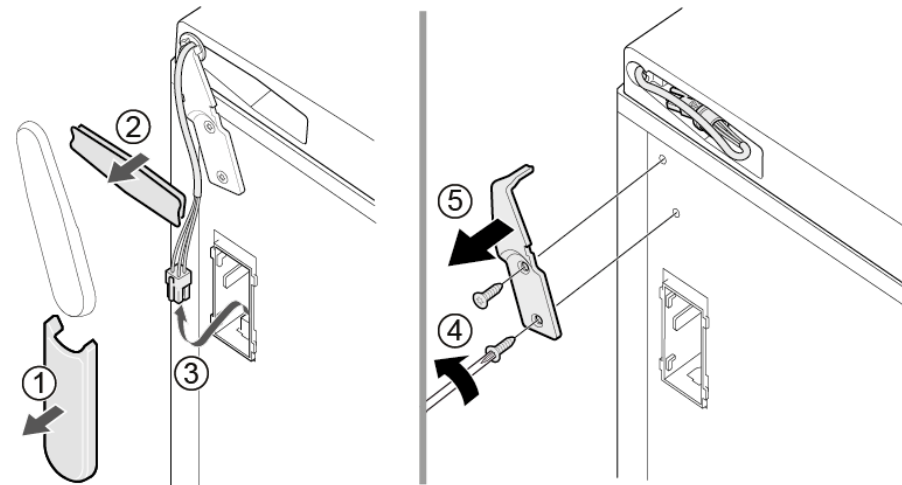

➡ Ο επάνω μεντεσές έχει αφαιρεθεί.

## 4.5.2 Τοποθέτηση μεντεσέ πόρτας

- ▶ Εγκαταστήστε με την αντίθετη σειρά.

## 4.6 Αντικατάσταση κάτω μεντεσέ πόρτας

Ειδικά βοηθητικά μέσα:

 Μύτη Torx TX20      6,3 mm (1/4")      [00340865]

	<p style="text-align: center;"><b>⚠ ΠΡΟΕΙΔΟΠΟΙΗΣΗ</b></p> <p><b>Βαριές, ογκώδεις συσκευές!</b> Τραυματισμοί μέσης και μυών</p> <ul style="list-style-type: none"> <li>▶ Η διαδικασία αφαίρεσης της πόρτας της συσκευής πρέπει να εκτελείται μόνο από εκπαιδευμένους ειδικούς.</li> <li>▶ Η μετακίνηση της συσκευής πρέπει να εκτελείται από δύο άτομα.</li> <li>▶ Χρησιμοποιείτε μόνο κατάλληλα εργαλεία και εξοπλισμό.</li> </ul>
--	--





	<p style="text-align: center;"><b>⚠ ΠΡΟΣΟΧΗ</b></p> <p><b>Αιχμηρές ακμές!</b> Τραυματισμοί από κοπή</p> <ul style="list-style-type: none"> <li>▶ Φοράτε προστατευτικά γάντια.</li> </ul>
--	--

	<p style="text-align: center;"><b>⚠ ΠΡΟΕΙΔΟΠΟΙΗΣΗ</b></p> <p><b>Ολίσθηση κεκλιμένων συσκευών!</b> Κατάγματα οστών/τραυματισμοί σύνθλιψης</p> <ul style="list-style-type: none"> <li>▶ Ασφαλίστε τις συσκευές από ολίσθηση.</li> </ul>
--	---

	<p style="text-align: center;"><b>⚠ ΠΡΟΣΟΧΗ</b></p> <p><b>Κίνδυνοι από πτώση μερών εξαιτίας χαλαρών βιδών!</b> Τραυματισμός εξαιτίας πτώσης τμημάτων.</p> <ul style="list-style-type: none"> <li>▶ Ασφαλίστε τα εξαρτήματα από πτώση.</li> </ul>
---	--

	<p style="text-align: center;"><b>ΠΡΟΣΟΧΗ!</b></p> <p><b>Κίνδυνων από πτώση εξαρτημάτων εξαιτίας χαλαρών βιδών!</b> Ζημιά σε άλλα μέρη της συσκευής ή στην οικία του πελάτη, π.χ. δάπεδο.</p> <ul style="list-style-type: none"> <li>▶ Ασφαλίστε τα εξαρτήματα από πτώση.</li> </ul>
--	--

**Προϋπόθεση:**

-  Η συσκευή είναι αποσυνδεδεμένη από την παροχή τροφοδοσίας.
-  Αφαιρούνται τα εσωτερικά εξαρτήματα συσκευής.
-  Η συσκευή είναι τοποθετημένη στην πίσω πλευρά.
-  [Ο επάνω μεντεσές έχει αφαιρεθεί. → 242](#)

### 4.6.1 Αντικατάσταση κάτω μεντεσέ πόρτας

1. Αφαιρέστε την πόρτα.

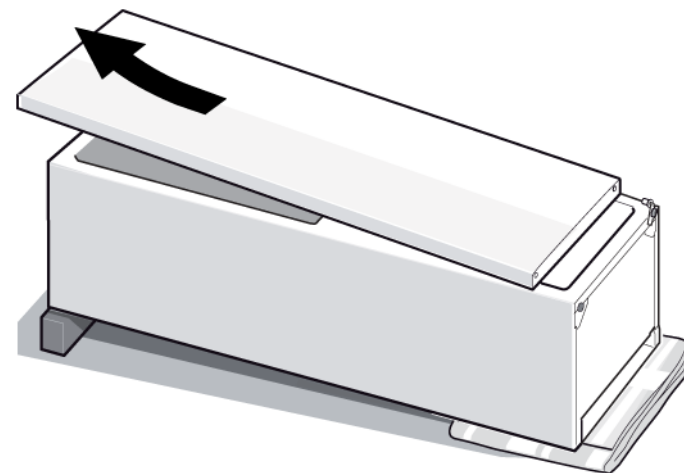

- 2.
1. Ξεβιδώστε τη βίδα (1).
  2. Γυρίστε τον κάτω μεντεσέ προς τα έξω (2).
  3. Αφαιρέστε τον κάτω μεντεσέ (3).

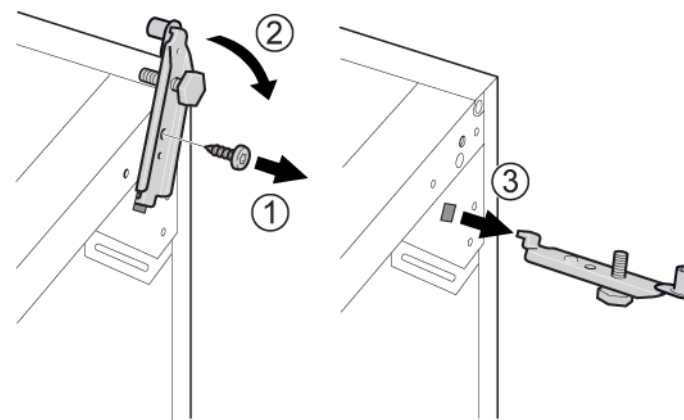

 Ο κάτω μεντεσές έχει αφαιρεθεί.

### 4.6.2 Τοποθέτηση κάτω μεντεσέ πόρτας

- ▶ Εγκαταστήστε με την αντίθετη σειρά.

## 4.7 Αντικατάσταση ραφιού

Προϋπόθεση:

- ✔ Η πόρτα είναι ανοιχτή.

### 4.7.1 Αφαίρεση ραφιού

- ▶ Τραβήξτε το ράφι προς τα έξω.

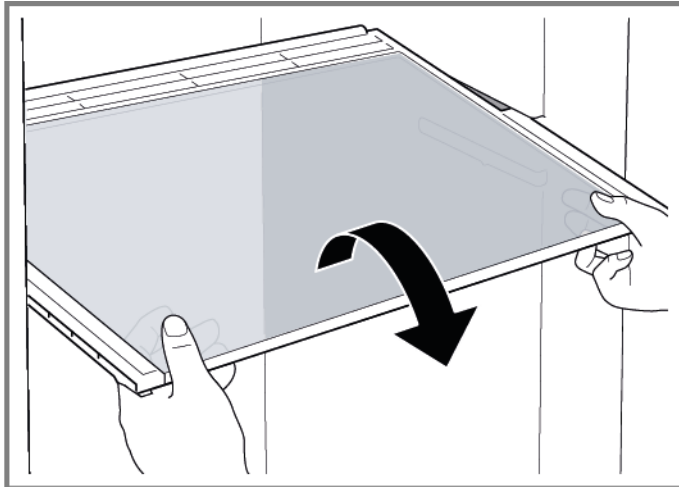

- ➡ Το ράφι αφαιρέθηκε.

### 4.7.2 Τοποθέτηση ραφιού

- ▶ Εγκαταστήστε με την αντίθετη σειρά.

## 4.8 Αντικατάσταση συρταριού κατεψυγμένων τροφίμων

Προϋπόθεση:

- ✔ Η πόρτα είναι ανοιχτή.

### 4.8.1 Αφαίρεση συρταριού κατεψυγμένων τροφίμων

- ▶ 1. Τραβήξτε προς τα έξω ολόκληρο το συρτάρι κατεψυγμένων τροφίμων (1).
- ▶ 2. Αφαιρέστε το συρτάρι κατεψυγμένων τροφίμων (2).

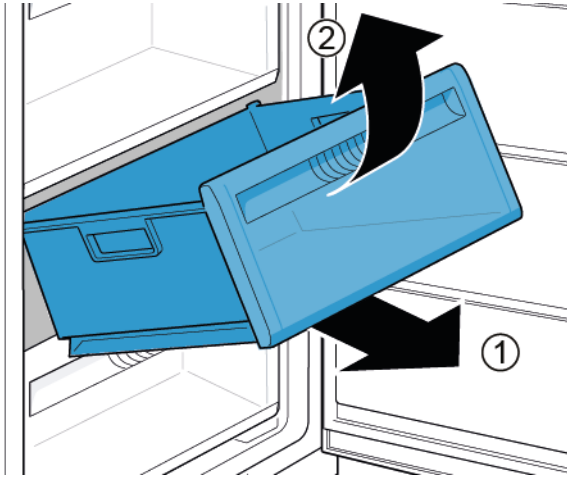

- ➡ Το συρτάρι κατεψυγμένων τροφίμων έχει αφαιρεθεί.

### 4.8.2 Τοποθέτηση συρταριού κατεψυγμένων τροφίμων

- ▶ Εγκαταστήστε με την αντίθετη σειρά.

## 4.9 Αντικατάσταση παρασκευαστή πάγου

Προϋπόθεση:

- ✔ Η πόρτα είναι ανοιχτή.

### 4.9.1 Αφαίρεση παρασκευαστή πάγου

- ▶ 1. Τραβήξτε προς τα έξω ολόκληρο το ράφι του συρταριού κατεψυγμένων τροφίμων με παρασκευαστή πάγου (1).
- ▶ 2. Απελευθερώστε τα άγκιστρα (2).
- ▶ 3. Αφαιρέστε τον παρασκευαστή πάγου (3).

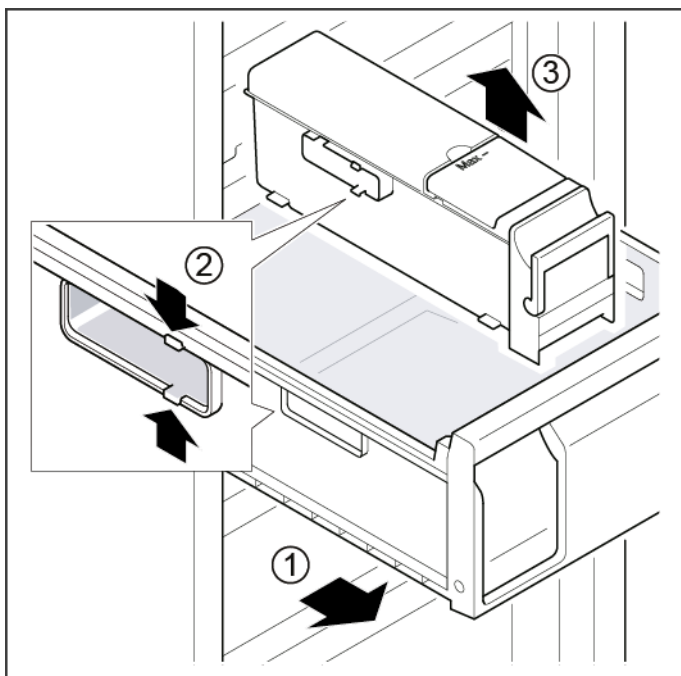

➡ Ο παρασκευαστής πάγου αφαιρέθηκε.

### 4.9.2 Τοποθέτηση παρασκευαστή πάγου

- ▶ Εγκαταστήστε με την αντίθετη σειρά.



## 4.10 Αντικατάσταση επάνω φωτός LED

Ειδικά βοηθητικά μέσα:

- Πλακέ κατασβίδι
- Λεπίδα 2,4 mm x 0,4 mm x 60 mm, στο κιτ [00341820]

**i** Η συσκευή διαθέτει ένα φως LED που δεν χρειάζεται συντήρηση. Αυτά τα φώτα μπορούν να επισκευαστούν μόνο από την εξυπηρέτηση πελατών ή από εξουσιοδοτημένους τεχνικούς!

**⚠ ΚΙΝΔΥΝΟΣ**  
**Κίνδυνος ηλεκτροπληξίας λόγω ηλεκτροφόρων μερών!**  
Κίνδυνος για τη ζωή από ηλεκτροπληξία σε περίπτωση ακατάλληλης επισκευής

- Τα ηλεκτρικά μέρη πρέπει να επισκευάζονται από εκπαιδευμένους ηλεκτρολόγους.
- Μετά την επισκευή πραγματοποιήστε έλεγχο ασφάλειας σύμφωνα με το VDE 0701 ή κανονισμούς της συγκεκριμένης χώρας.

**⚠ ΚΙΝΔΥΝΟΣ**  
**Κίνδυνος ηλεκτροπληξίας λόγω ηλεκτροφόρων μερών!**  
Θάνατος από ηλεκτροπληξία

- Αποσυνδέετε τις συσκευές από την παροχή ηλεκτρικού ρεύματος τουλάχιστον 60 δευτερόλεπτα πριν ξεκινήσετε τις επισκευές.

**⚠ ΠΡΟΣΟΧΗ**  
**Αιχμηρές ακμές!**  
Τραυματισμοί από κοπή

- Φοράτε προστατευτικά γάντια.

Προϋπόθεση:

- ✓ Η συσκευή είναι αποσυνδεδεμένη από την παροχή τροφοδοσίας.
- ✓ Η πόρτα είναι ανοιχτή.
- ✓ Αφαιρούνται τα επάνω εσωτερικά εξαρτήματα.

### 4.10.1 Αφαίρεση φωτός LED

1. Μετακινήστε το φως LED στην αριστερή πλευρά.



➡ Η ηλεκτρική σύνδεση φωτισμού LED είναι αποσυνδεδεμένη.

2. Απελευθερώστε τα άγκιστρα φωτισμού LED.

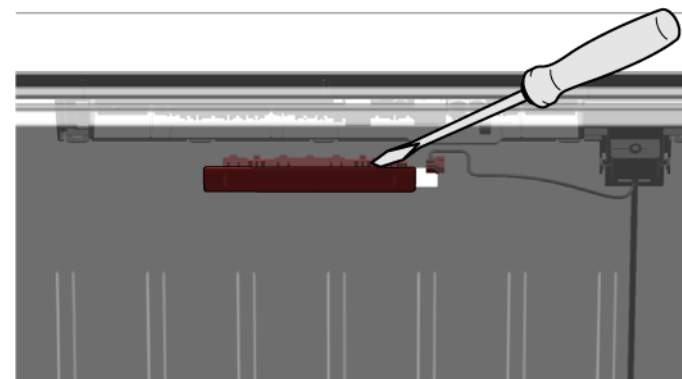

3. Αφαιρέστε το φως LED, μετακινώντας το προς τα εμπρός.

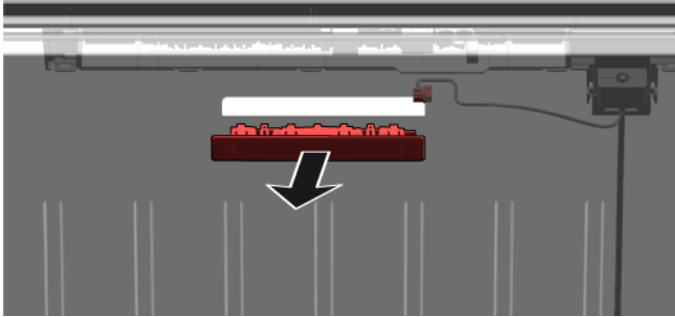

- ➔ Το φως LED αφαιρέθηκε.

### 4.10.2 Τοποθέτηση επάνω φωτισμού LED

- ▶ Εγκαταστήστε με την αντίθετη σειρά.

# Javítási útmutató - Fagyasztószekrény

## **A dokumentummal kapcsolatos információk.....252**

1.1	Fontos tudnivalók .....	252
1.1.1	Cél .....	252
1.2	Szimbólummagyarázat .....	252
1.2.1	Veszélyességi szintek .....	252
1.2.2	Veszélyt jelző szimbólumok .....	252
1.2.3	A figyelmeztetések felépítése .....	253
1.2.4	Általános szimbólumok.....	253

## **Biztonság .....254**

2.1	Általános biztonsági utasítások.....	254
2.1.1	Összes háztartási készülék .....	254

## **Szerszámok és segédanyagok.....255**

## **Javítás .....256**

4.1	A gumitömítés cseréje .....	256
4.1.1	A gumitömítés eltávolítása.....	256
4.1.2	A gumitömítés beszerelése.....	256
4.2	A fogantyú cseréje.....	259
4.2.1	A fogantyú eltávolítása .....	259
4.2.2	A fogantyú felszerelése .....	259
4.3	Az easy opening handle fogantyú cseréje .....	260
4.3.1	Az easy opening handle fogantyú eltávolítása.....	260
4.3.2	Az easy opening handle fogantyú felszerelése.....	260
4.4	A felső ajtózsanér cseréje .....	261
4.4.1	Az ajtózsanér eltávolítása.....	261
4.4.2	Az ajtózsanér felszerelése .....	263
4.5	A felső ajtózsanér cseréje (kijelzős ajtó).....	264
4.5.1	Az ajtózsanér eltávolítása .....	265
4.5.2	Az ajtózsanér felszerelése .....	266
4.6	Az alsó ajtózsanér cseréje .....	267
4.6.1	Az alsó ajtózsanér cseréje .....	267
4.6.2	Az alsó ajtózsanér felhelyezése .....	268
4.7	A polc cseréje .....	269
4.7.1	A polc eltávolítása .....	269
4.7.2	A polc beszerelése.....	269

4.8	Fagyasztódoboz cseréje.....	270
4.8.1	Fagyasztódoboz eltávolítása .....	270
4.8.2	A fagyasztódoboz behelyezése .....	270
4.9	A jégkészítő cseréje .....	271
4.9.1	A jégkészítő eltávolítása .....	271
4.9.2	A jégkészítő beszerelése .....	271
4.10	Felső LED-világítás cseréje .....	272
4.10.1	LED-világítás eltávolítása.....	272
4.10.2	A felső LED-világítás beszerelése .....	273

# **i** A dokumentummal kapcsolatos információk

## 1.1 Fontos tudnivalók

### 1.1.1 Cél

Ezek a javítási tanácsok támogatják a fogyasztót a készülékek otthoni megjavításában a környezettudatos tervezésről szóló rendeletnek (2021 márciusától alkalmazandó) megfelelően.





Információkat tartalmaznak bizonyos pótalkatrészek cseréjével kapcsolatban, ideértve a figyelmeztetéseket és a kockázatokat is.

Ha kérdése van, vegye fel a kapcsolatot a vevőszolgálattal. A károkért kizárólag akkor vállalunk felelősséget, ha a javítási tanácsokat pontosan betartották.

## 1.2 Szimbólummagyarázat

### 1.2.1 Veszélyességi szintek

A veszélyességi szintek egy szimbólumból és egy figyelmeztető mondatból állnak. A figyelmeztető mondat utal a veszély súlyosságára.





Veszélyességi szint	Jelentés
 <b>VESZÉLY</b>	A figyelmeztető üzenet figyelmen kívül hagyása halált vagy súlyos sérüléseket okoz.
 <b>FIGYELMEZTETÉS</b>	A figyelmeztető üzenet figyelmen kívül hagyása halált vagy súlyos sérüléseket okozhat.
 <b>VIGYÁZAT</b>	A figyelmeztető üzenet figyelmen kívül hagyása kisebb sérüléseket okozhat.
 <b>FIGYELEM!</b>	A figyelmeztető üzenet figyelmen kívül hagyása anyagi károkat okozhat.

Táblázat 1: Veszélyességi szintek

### 1.2.2 Veszélyt jelző szimbólumok

A veszélyt jelző szimbólumok a veszélyt ábrázoló szimbolikus ábrázolások.

A jelen dokumentumban az alábbi veszélyt jelző szimbólumok használatosak:

Veszélyt jelző szimbólum	Jelentés
	Általános figyelmeztető üzenet
	Elektromos feszültség veszélye
	Robbanásveszély
	Vágásveszély
	Zúzódásveszély

## **i** A dokumentummal kapcsolatos információk

Veszélyt jelző szimbólum	Jelentés
	Forró felületek miatt fennálló veszély
	Erős mágneses mező miatt fennálló veszély
	Nem ionizáló sugárzás veszélye

Táblázat 2: Veszélyt jelző szimbólumok

### 1.2.3 A figyelmeztetések felépítése

A jelen dokumentumban lévő figyelmeztetések szabványosított megjelenésűek és felépítésűek.

	<p><b>⚠ VESZÉLY</b></p> <p><b>A veszély típusa és forrása!</b> A veszély / figyelmeztetés figyelmen kívül hagyásának lehetséges következményei.</p> <ul style="list-style-type: none"> <li>▶ A veszély megelőzésére szolgáló intézkedések és tiltások.</li> </ul>
--	---

Az alábbi példa egy olyan figyelmeztetést mutat be, amely az áram alatt lévő alkatrészek okozta áramütésre figyelmeztet. Megemlíti a veszély elkerülésére szolgáló intézkedést.

	<p><b>⚠ VESZÉLY</b></p> <p><b>Áramütés veszélye áram alatt lévő alkatrészek miatt!</b> Halálos áramütés</p> <ul style="list-style-type: none"> <li>▶ A javítás megkezdése előtt legalább 60 másodperccel válassza le a készülékeket az elektromos hálózatról.</li> </ul>
--	--

### 1.2.4 Általános szimbólumok

A jelen dokumentumban az alábbi általános szimbólumok használatosak:

Ált. szimbólum	Jelentés
	Különleges tanács (szöveg és/vagy grafika)

Ált. szimbólum	Jelentés
	Egyszerű tanács (csak szöveg)
	Videós oktatóanyagra mutató hivatkozás
	A szükséges eszközök
	A szükséges feltételek
	Feltétel (ha..., akkor...)
	Eredmény
[Indítás]	Billentyű vagy gomb
[00123456]	Anyagszám azonosítója
Állapot	Megjelenített szöveg / ablak (a készülék kijelzőjén)

Táblázat 3: Általános szimbólumok

## 2.1 Általános biztonsági utasítások

### 2.1.1 Összes háztartási készülék

#### **Áramütés veszélye áram alatt lévő alkatrészek miatt!**

- Az elektromos alkatrészek hibás javítása áramütéshez vezethet!
- A javítás megkezdése előtt legalább 60 másodperccel válassza le a készüléket az elektromos hálózatról.
- A javítás után végeztesse a VDE 0701-nek vagy az országspecifikus szabályozásoknak megfelelő vizsgálatot.

#### **Éles peremek miatt fennálló sérülésveszély!**

- Viseljen védőkesztyűt.

#### **Zúzódásveszély a javítás, karbantartás, hibaelhárítás és szervizelés során a nehéz és mozgó alkatrészek miatt**

- Viseljen védőcipőt.
- Biztosítsa leesés ellen a nehéz alkatrészeket.
- Ne dugja be a testrészeit a mozgó alkatrészek közé.



#### **Sérülhet a készülék biztonsága / működése!**

- Kizárólag eredeti pótalkatrészeket használjon.

#### **Elektrosztatikailag érzékeny alkatrészek (ESD-k) károsodásának veszélye!**

- Ne érintse meg a modulokat, ideértve a csatlakozásokat és a vezetőket.

## Szerszámok és segédanyagok

Kijelölés	Részletek	Képek
Védőrongy [00342013]	60 cm x 50 cm	
PH2 csillagcsavar- húzó		
TX20 Torx bithegy [00340865]	6,3 mm (1/4")	
Laposfejű csavar- húzó	Hegy 2,4 mm x 0,4 mm x 60 mm, a készletben [00341820]	

## 4.1 A gumitömítés cseréje

### Követelmény:

- ✓ Az ajtó nyitva van

### 4.1.1 A gumitömítés eltávolítása

1. Vegye ki a gumitömítést a barázdából a jobb és a bal sarokban.

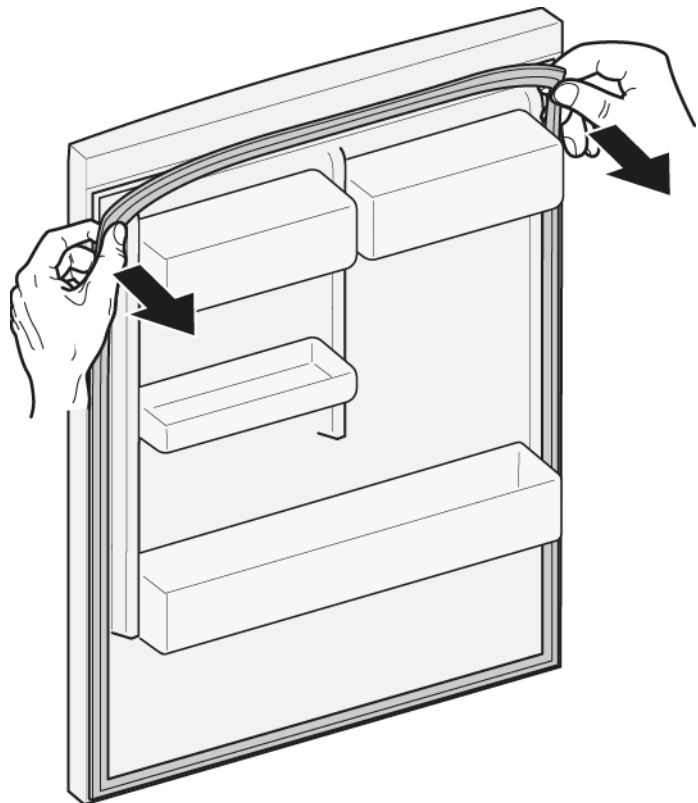

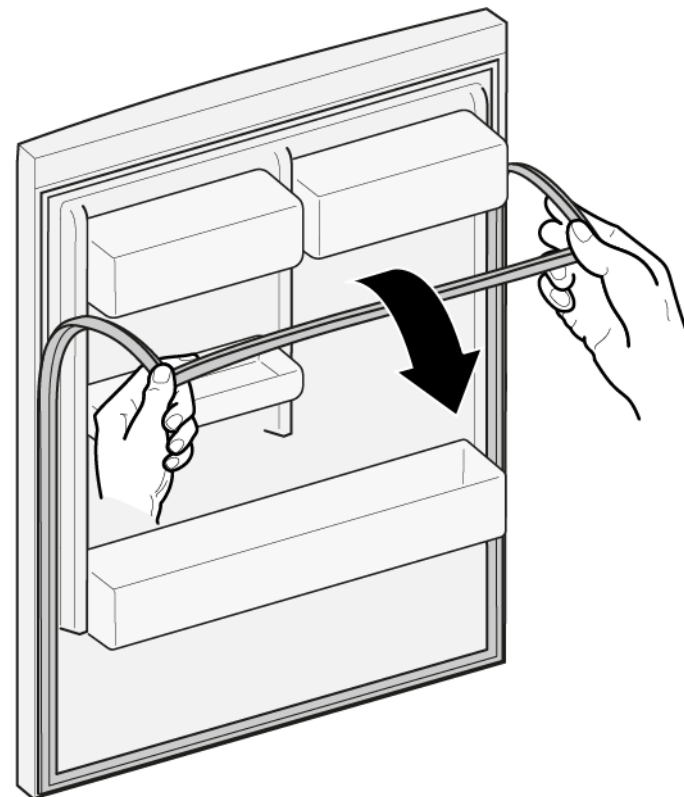

2. Húzza ki a gumitömítést a barázdából.



- ➡ Eltávolította a gumitömítést.

### 4.1.2 A gumitömítés beszerelése

	Az új gumitömítés vastagsága enyhén eltérhet a régi gumitömítés vastagságától. Ez nem befolyásolja az ajtócsukás módját és hosszú távú működését.
	Ha a készülékében beállítható zsanérok vagy zsanérrögzítések vannak, utólag optimalizálhatja a becsukás módját.
	A gumitömítésben lévő apró, oldalsó lyukak funkcionálisak (a szellőzéshez szükségesek). Ezek nem gyártási hibák.



1. Ellenőrizze a barázdát sérülések szempontjából.

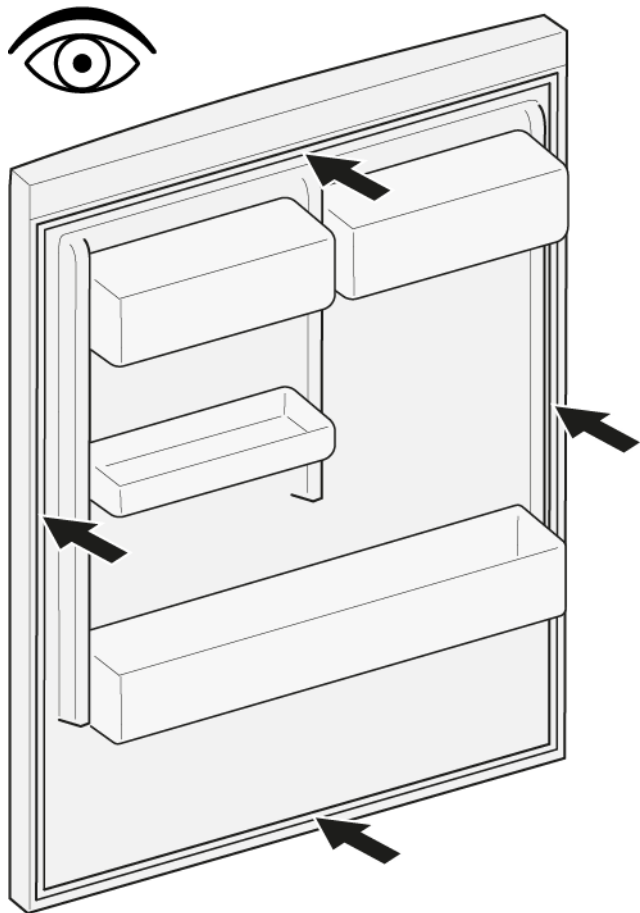

4. Nyomja a gumitömítés fenti és lenti sarkait a barázdába.

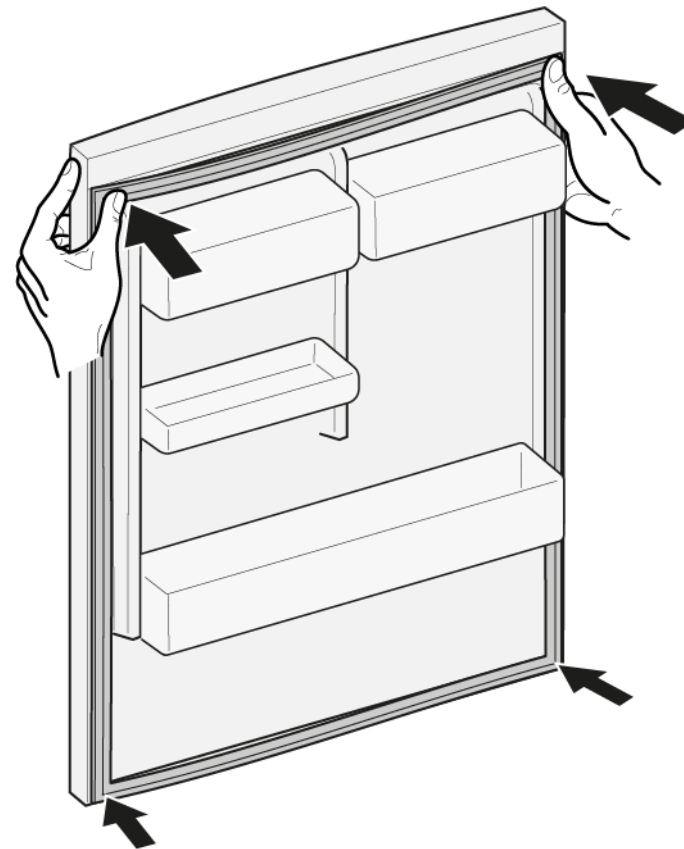

2. ⓘ Ha a gumitömítés barázdája sérült:  
- Vegye fel a kapcsolatot az ügyfélszolgálattal.

3. ⓘ A gumitömítés enyhe deformálódása normális, és nem befolyásolja a működését. Javasolt a gumitömítés kiegyenesítése a készülékbe történő behelyezés előtt.

Hajszárítóval vagy forró vízzel melegítse fel a gumitömítést, és kézzel formázza újra.

5. Nyomja a teljes gumitömítést apránként a barázdába.

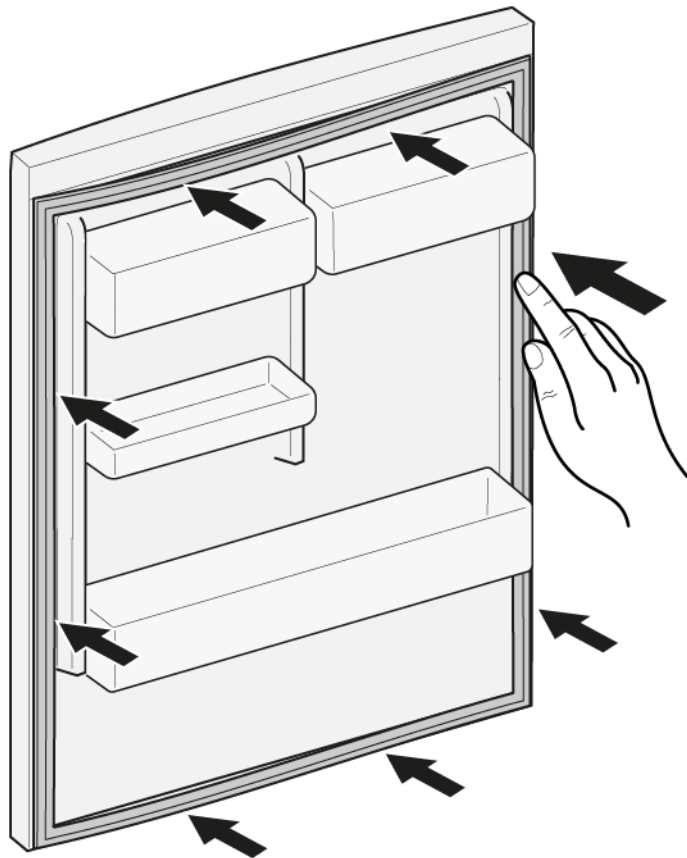

-  Beszerelte a gumitömítést.

## 4.2 A fogantyú cseréje

### Különleges eszközök

- TX20 Torx bithegy 6,3 mm (1/4") [00340865]
- Laposfejű csavarhúzó Hegy 10 mm x 1,6 mm x 200 mm

### Követelmény:

- ✓ A készüléket leválasztotta az áramellátásról.
- ✓ Az ajtó nyitva van

### 4.2.1 A fogantyú eltávolítása

- ▶ 1. Távolítsa el a két csavarfedelelet (1).
- ▶ 2. Csavarja ki a két csavart (2).
- ▶ 3. Távolítsa el a fogantyút (3).

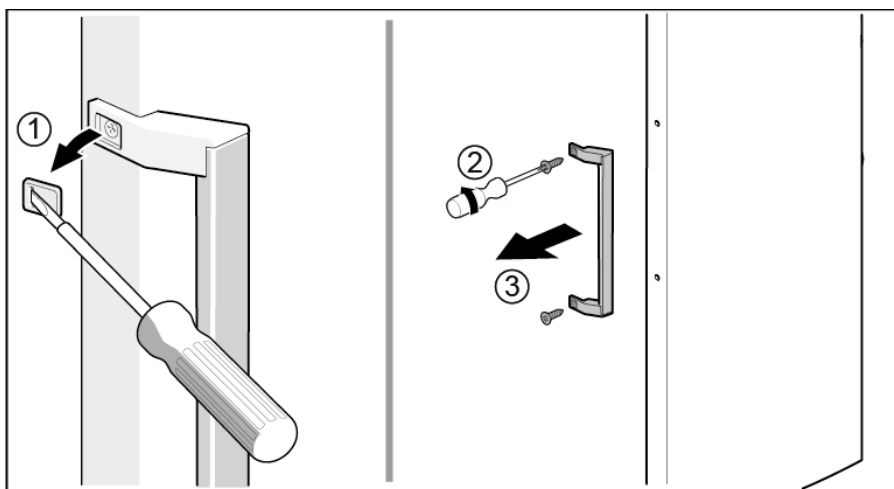

- ➡ Eltávolította a fogantyút.

### 4.2.2 A fogantyú felszerelése



- ▶ Az elhelyezést fordított sorrendben végezze.

### 4.3 Az easy opening handle fogantyú cseréje

#### Különleges eszközök

-  PH2 csillagcsavarhúzó

#### Követelmény:

-  A készüléket leválasztotta az áramellátásról.
-  Az ajtó nyitva van

#### 4.3.1 Az easy opening handle fogantyú eltávolítása

- ▶ 1. Távolítsa el az easy opening handle fogantyú fedelét (1).
- ▶ 2. Csavarja ki a két csavart (2).

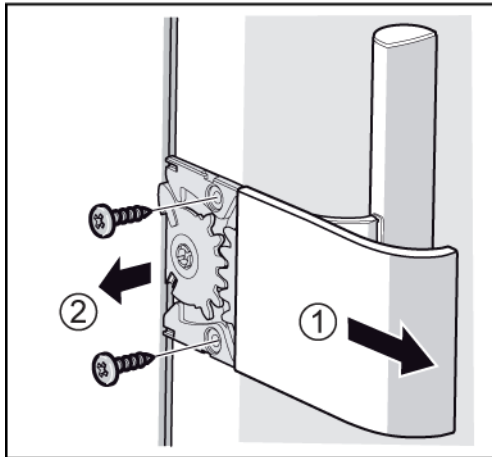

-  Eltávolította az easy opening handle fogantyút.

### 4.3.2 Az easy opening handle fogantyú felszerelése

Az easy opening handle fogantyú mechanizmusát felszerelés előtt megfelelően be kell állítani.

A képen a tolórúd (1), a fogazott negyedkörívek (2) és (3), rugó (4) ütköző (5) helyes elrendezése látható bal oldali felszerelés esetén.

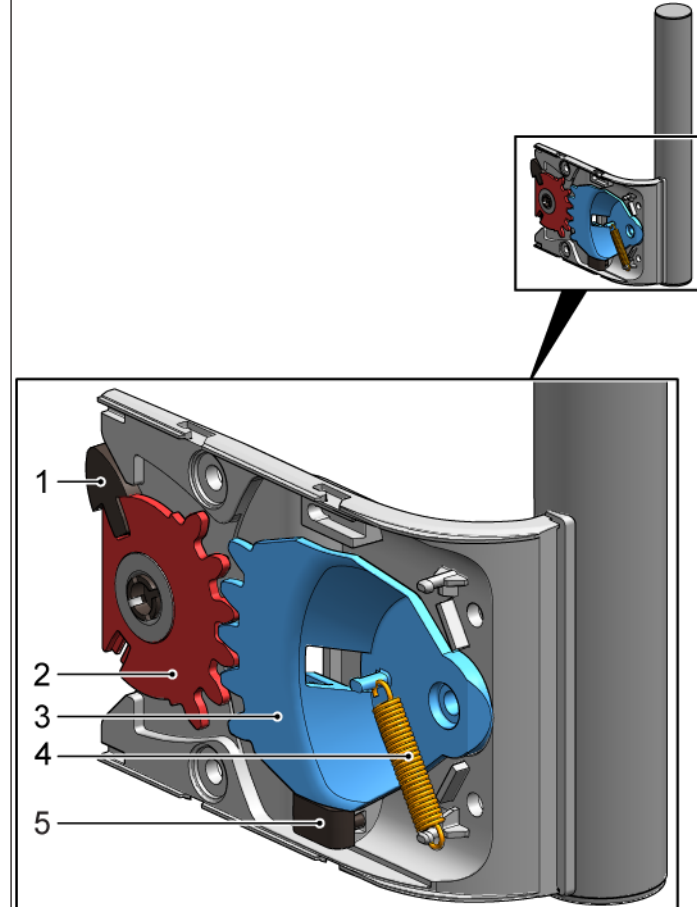

Az easy opening handle fogantyú alkatrészeinek jobb oldali felszerelésének leírása a Beszerelési útmutató dokumentumban található.

- ▶ Az elhelyezést fordított sorrendben végezze.



## 4.4 A felső ajtózsanér cseréje

### Különleges eszközök



 TX20 Torx bithegy

6,3 mm (1/4")

[00340865]

	<p><b>⚠ FIGYELMEZTETÉS</b></p> <p><b>Nehéz, nagy készülékek!</b> Hát- és izomsérülések</p> <ul style="list-style-type: none"><li>▶ A készülék ajtajának eltávolítását kizárólag szakemberrel végeztesse.</li><li>▶ A készülék elmozdításához két emberre van szükség.</li><li>▶ Kizárólag megfelelő eszközöket és berendezéseket használjon.</li></ul>
	<p><b>⚠ VIGYÁZAT</b></p> <p><b>Éles szélek!</b> Vágási sérülések</p> <ul style="list-style-type: none"><li>▶ Viseljen védőkesztyűt.</li></ul>
	<p><b>⚠ FIGYELMEZTETÉS</b></p> <p><b>Megdöntött készülékek elcsúszása!</b> Csonttörés / zúzódási sérülések</p> <ul style="list-style-type: none"><li>▶ Biztosítsa a készülékeket elcsúszás ellen.</li></ul>
	<p><b>⚠ VIGYÁZAT</b></p> <p><b>Leeső alkatrészek veszélye a kioldott csavarok miatt!</b> Leeső alkatrészek miatti sérülés.</p> <ul style="list-style-type: none"><li>▶ Biztosítsa az alkatrészt leesés ellen.</li></ul>
	<p><b>FIGYELEM!</b></p> <p><b>Leeső alkatrészek veszélye a kioldott csavarok miatt!</b> A készülék többi részeinek vagy az ügyfél lakásának (pl. padló) károsodása.</p> <ul style="list-style-type: none"><li>▶ Biztosítsa az alkatrészt leesés ellen.</li></ul>

### Követelmény:

-  A készüléket leválasztotta az áramellátásról.
-  Eltávolította a készülék belső szerelvényeit.

## 4.4.1 Az ajtózsanér eltávolítása

1. Fordítsa a készüléket a hátára.

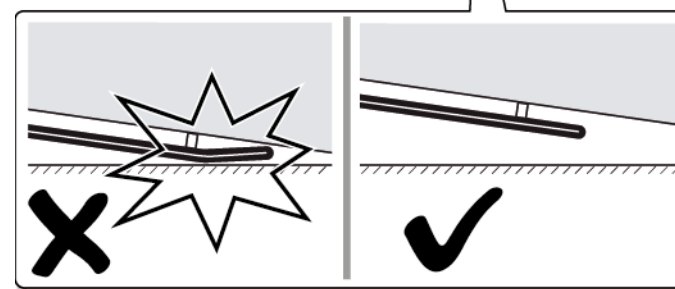
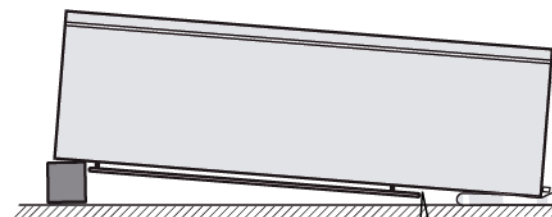
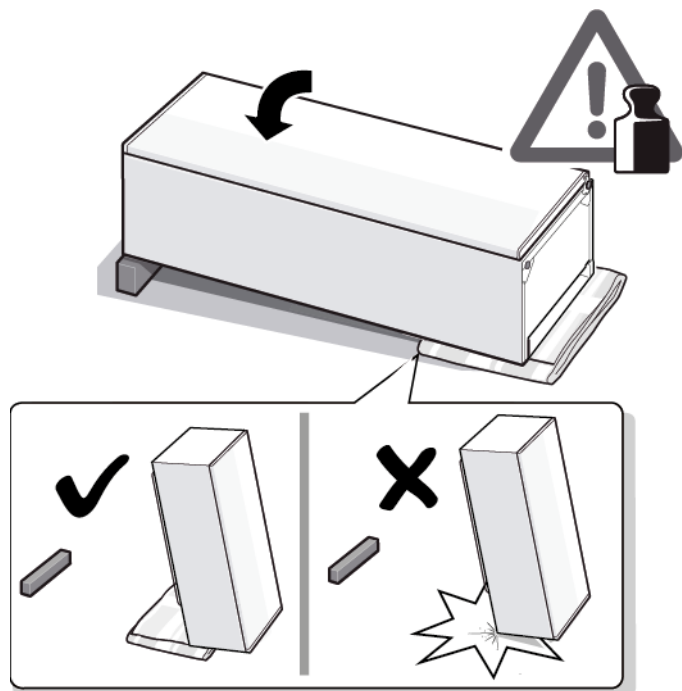

2. 1. Nyomja meg mindkét oldalon a felső zsanér burkolatát (1).  
2. Húzza el a felső zsanér burkolatát (2).  
3. Távolítsa el a felső zsanér burkolatát (3).

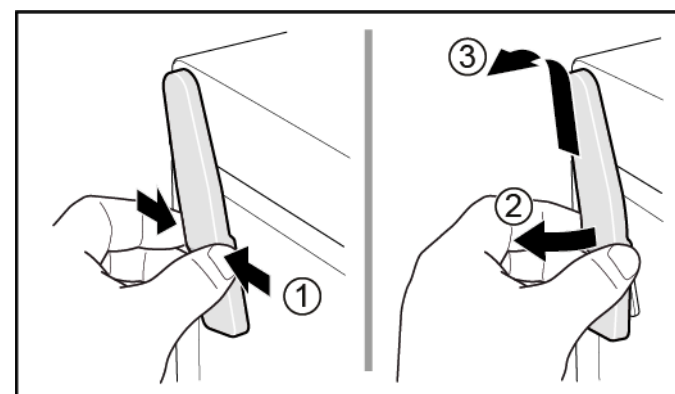

3.
  1. Csavarja ki a két csavart (1).
  2. Távolítsa el a felső zsanért (2).

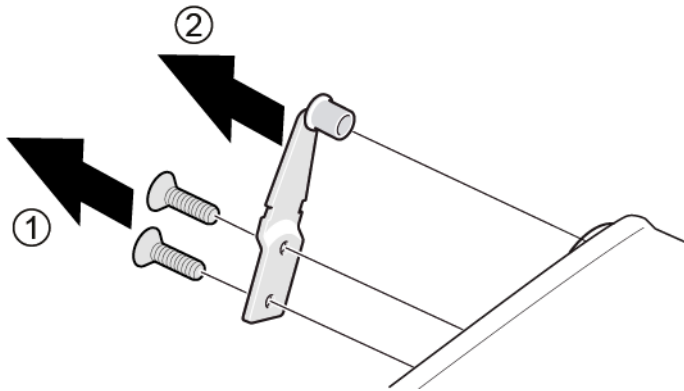

 Eltávolította az ajtó felső zsanérját.

#### 4.4.2 Az ajtózsánér felszerelése

- ▶ Az elhelyezést fordított sorrendben végezze.

## 4.5 A felső ajtózsaner cseréje (kijelzős ajtó)

### Különleges eszközök

 TX20 Torx bithegy 6,3 mm (1/4") [00340865]

	<b>⚠ FIGYELMEZTETÉS</b>
	<p><b>Nehéz, nagy készülékek!</b> Hát- és izomsérülések</p> <ul style="list-style-type: none"> <li>▶ A készülék ajtajának eltávolítását kizárólag szakemberrel végeztesse.</li> <li>▶ A készülék elmozdításához két emberre van szükség.</li> <li>▶ Kizárólag megfelelő eszközöket és berendezéseket használjon.</li> </ul>

	<b>⚠ VIGYÁZAT</b>
	<p><b>Éles szélek!</b> Vágási sérülések</p> <ul style="list-style-type: none"> <li>▶ Viseljen védőkesztyűt.</li> </ul>

	<b>⚠ FIGYELMEZTETÉS</b>
	<p><b>Megdöntött készülékek elcsúszása!</b> Csonttörés / zúzódási sérülések</p> <ul style="list-style-type: none"> <li>▶ Biztosítsa a készülékeket elcsúszás ellen.</li> </ul>



	<b>⚠ VIGYÁZAT</b>
	<p><b>Leeső alkatrészek veszélye a kioldott csavarok miatt!</b> Leeső alkatrészek miatti sérülés.</p> <ul style="list-style-type: none"> <li>▶ Biztosítsa az alkatrészt leesés ellen.</li> </ul>

	<b>FIGYELEM!</b>
	<p><b>Leeső alkatrészek veszélye a kioldott csavarok miatt!</b> A készülék többi részeinek vagy az ügyfél lakásának (pl. padló) károsodása.</p> <ul style="list-style-type: none"> <li>▶ Biztosítsa az alkatrészt leesés ellen.</li> </ul>

	<b>⚠ VESZÉLY</b>
	<p><b>Áramütés veszélye áram alatt lévő alkatrészek miatt!</b> Életveszély a nem megfelelő javítás okozta áramütés miatt</p> <ul style="list-style-type: none"> <li>▶ Az elektromos alkatrészek javítását kizárólag képzett elektroműszerész végezheti.</li> <li>▶ A javítás után végeztesse a VDE 0701-nek vagy az országspecifikus szabályozásoknak megfelelő vizsgálatot.</li> </ul>

	<b>⚠ VESZÉLY</b>
	<p><b>Áramütés veszélye áram alatt lévő alkatrészek miatt!</b> Halálos áramütés</p> <ul style="list-style-type: none"> <li>▶ A javítás megkezdése előtt legalább 60 másodperccel válassza le a készülékeket az elektromos hálózatról.</li> </ul>

#### Követelmény:

-  A készüléket leválasztotta az áramellátásról.
-  Eltávolította a készülék belső szerelvényeit.



## 4.5.1 Az ajtózsánér eltávolítása

1. Fordítsa a készüléket a hátára.

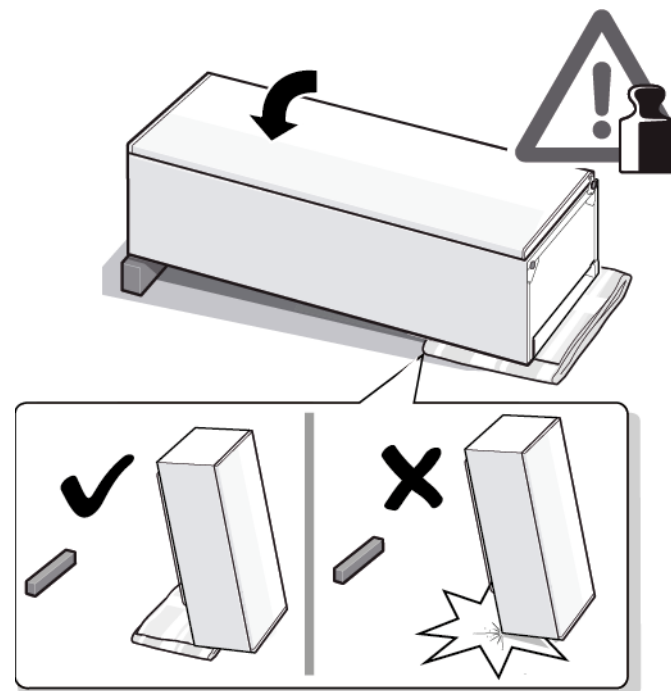

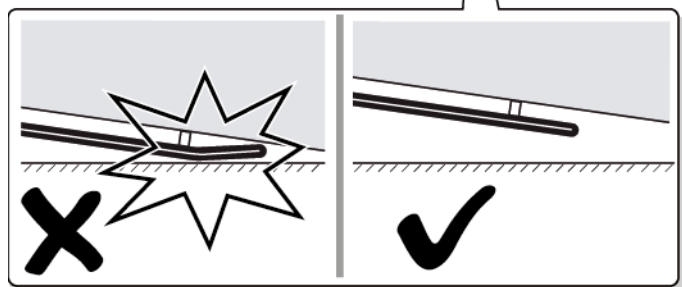
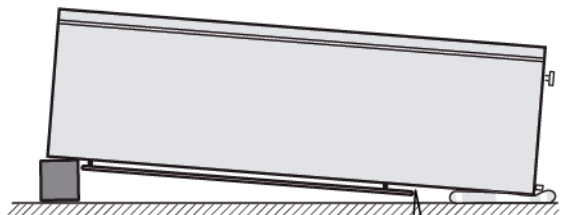

2. 1. Nyomja meg mindkét oldalon a felső zsanér burkolatát (1).
2. Húzza el a felső zsanér burkolatát (2).
3. Távolítsa el a felső zsanér burkolatát (3).

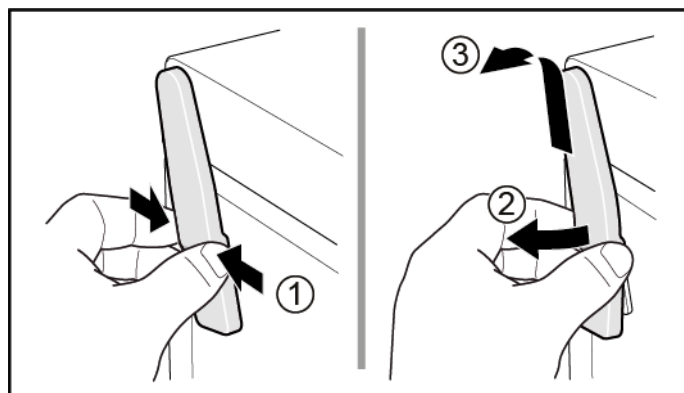

3. 1. Távolítsa el a kábeldoboz fedelét (1).
2. Távolítsa el a kábelburkolatot (2).
3. Válassza le az elektromos csatlakozást (3).
4. Csavarja ki a két csavart (4).
5. Távolítsa el a felső zsanért (5).

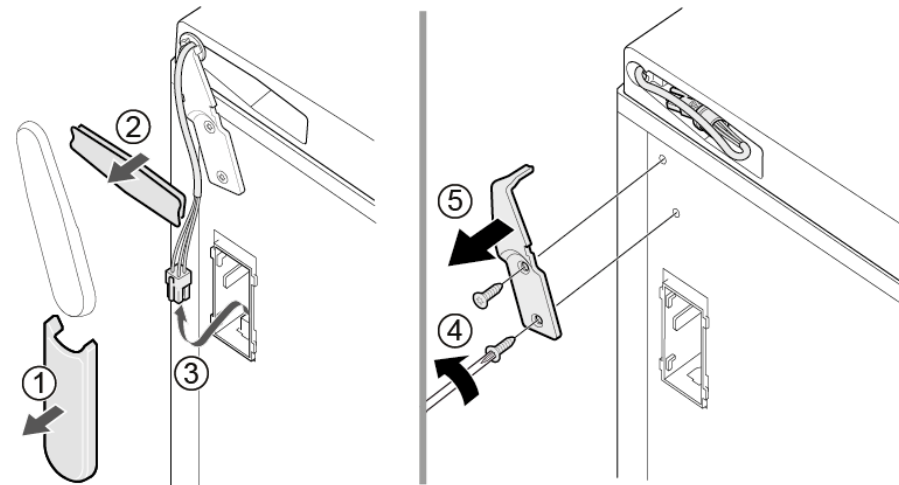

➔ Eltávolította az ajtó felső zsanérját.

#### 4.5.2 Az ajtózsánér felszerelése

- ▶ Az elhelyezést fordított sorrendben végezze.

## 4.6 Az alsó ajtózanér cseréje

### Különleges eszközök

TX20 Torx bithegy

6,3 mm (1/4")

[00340865]

	<b>⚠ FIGYELMEZTETÉS</b>
<p><b>Nehéz, nagy készülékek!</b> Hát- és izomsérülések</p> <ul style="list-style-type: none"> <li>▶ A készülék ajtajának eltávolítását kizárólag szakemberrel végeztesse.</li> <li>▶ A készülék elmozdításához két emberre van szükség.</li> <li>▶ Kizárólag megfelelő eszközöket és berendezéseket használjon.</li> </ul>	

	<b>⚠ VIGYÁZAT</b>
<p><b>Éles szélek!</b> Vágási sérülések</p> <ul style="list-style-type: none"> <li>▶ Viseljen védőkesztyűt.</li> </ul>	

	<b>⚠ FIGYELMEZTETÉS</b>
<p><b>Megdöntött készülékek elcsúszása!</b> Csonttörés / zúzódási sérülések</p> <ul style="list-style-type: none"> <li>▶ Biztosítsa a készülékeket elcsúszás ellen.</li> </ul>	

	<b>⚠ VIGYÁZAT</b>
<p><b>Leeső alkatrészek veszélye a kioldott csavarok miatt!</b> Leeső alkatrészek miatti sérülés.</p> <ul style="list-style-type: none"> <li>▶ Biztosítsa az alkatrészt leesés ellen.</li> </ul>	

	<b>FIGYELEM!</b>
<p><b>Leeső alkatrészek veszélye a kioldott csavarok miatt!</b> A készülék többi részeinek vagy az ügyfél lakásának (pl. padló) károsodása.</p> <ul style="list-style-type: none"> <li>▶ Biztosítsa az alkatrészt leesés ellen.</li> </ul>	

### Követelmény:

- ✔ A készüléket leválasztotta az áramellátásról.
- ✔ Eltávolította a készülék belső szerelvényeit.
- ✔ A készüléket a hátára fordította.

✔ [Eltávolította a felső zsanért. → 264](#)

### 4.6.1 Az alsó ajtózanér cseréje

1. Vegye le az ajtót.

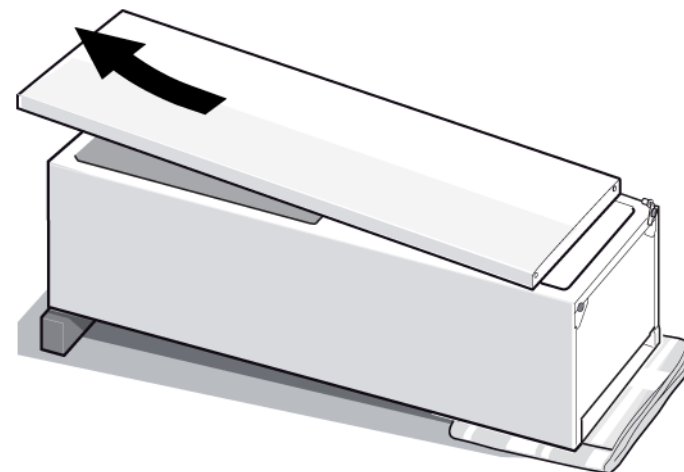

2. 1. Csavarja ki a csavart (1).
2. Fordítsa ki az alsó zsanért (2).
3. Távolítsa el az alsó zsanért (3).

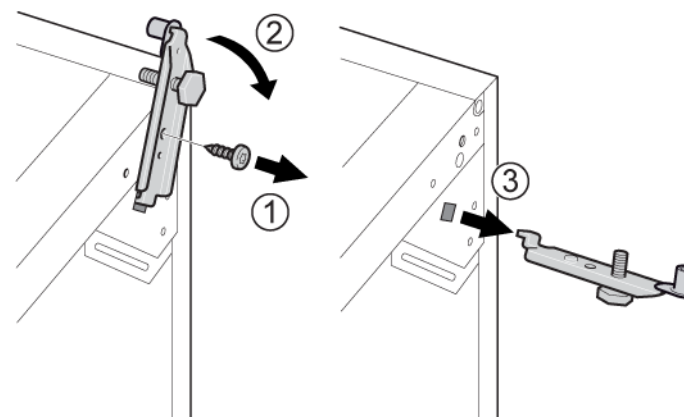

➡ Eltávolította az alsó zsanért.

#### **4.6.2 Az alsó ajtózanér felhelyezése**

- ▶ Az elhelyezést fordított sorrendben végezze.

## 4.7 A polc cseréje

### Követelmény:

- ✔ Az ajtó nyitva van

### 4.7.1 A polc eltávolítása

- ▶ Húzza ki a polcot.

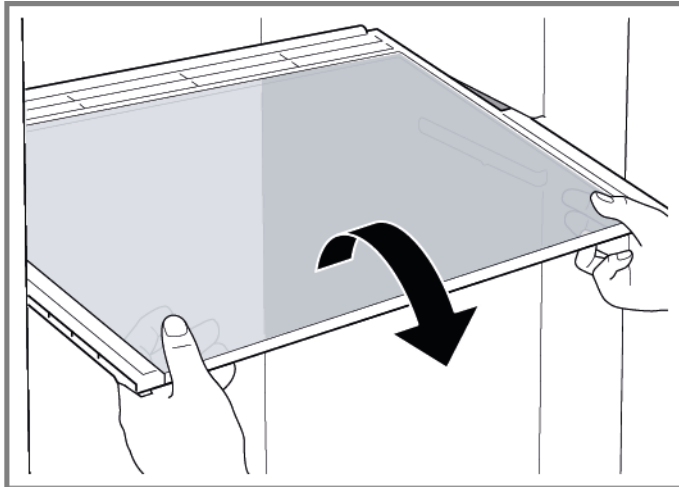

- ➡ Eltávolította a polcot.

### 4.7.2 A polc beszerelése

- ▶ Az elhelyezést fordított sorrendben végezze.

## 4.8 Fagyasztódoboz cseréje

### Követelmény:

- ✓ Az ajtó nyitva van

### 4.8.1 Fagyasztódoboz eltávolítása

- ▶ 1. Húzza ki teljesen a fagyasztódobozt (1).
- ▶ 2. Távolítsa el a fagyasztódobozt (2).

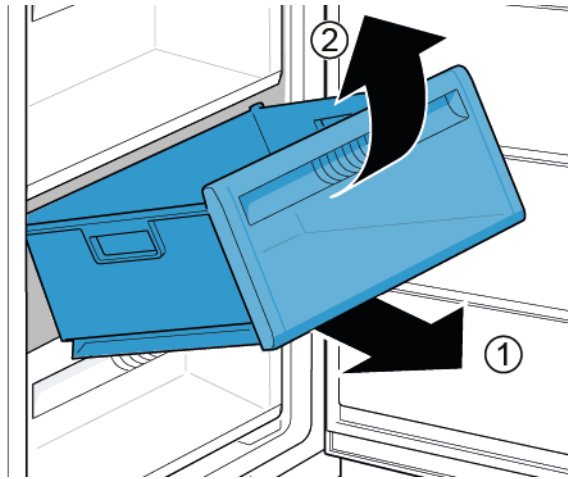

- ➡ Eltávolította a fagyasztódobozt.

### 4.8.2 A fagyasztódoboz behelyezése

- ▶ Az elhelyezést fordított sorrendben végezze.

## 4.9 A jégkészítő cseréje

### Követelmény:

- ✔ Az ajtó nyitva van

### 4.9.1 A jégkészítő eltávolítása

- ▶ 1. Húzza ki a fagyasztódobozt a jégkészítővel (1).
- ▶ 2. Oldja ki a horgokat (2).
- ▶ 3. Távolítsa el a jégkészítőt (3).

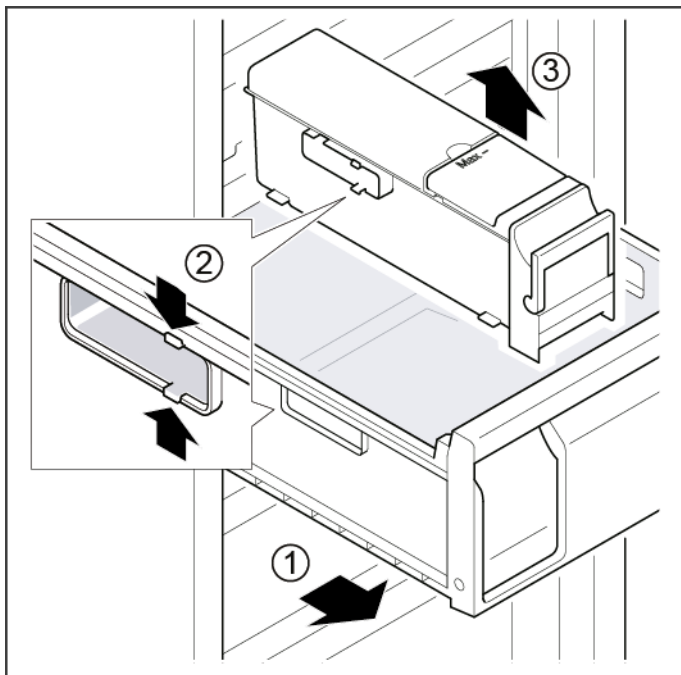

- ➡ Eltávolította a jégkészítőt.

### 4.9.2 A jégkészítő beszerelése

- ▶ Az elhelyezést fordított sorrendben végezze.

## 4.10 Felső LED-világítás cseréje

### Különleges eszközök

-  Laposfejű csavarhúzó Hegy 2,4 mm x 0,4 mm x 60 mm, a készletben [00341820]

 A készüléke karbantartásmentes LED-világítással rendelkezik. A világítást kizárólag az ügyfélszolgálat vagy szakképzett technikusok javíthatják meg!

 **⚠ VESZÉLY**  
**Áramütés veszélye áram alatt lévő alkatrészek miatt!**  
 Életveszély a nem megfelelő javítás okozta áramütés miatt

- ▶ Az elektromos alkatrészek javítását kizárólag képzett elektroműszerész végezheti.
- ▶ A javítás után végeztesen a VDE 0701-nek vagy az országspecifikus szabályozásoknak megfelelő vizsgálatot.



 **⚠ VESZÉLY**  
**Áramütés veszélye áram alatt lévő alkatrészek miatt!**  
 Halálos áramütés

- ▶ A javítás megkezdése előtt legalább 60 másodperccel válassza le a készülékeket az elektromos hálózatról.

 **⚠ VIGYÁZAT**  
**Éles szélek!**  
 Vágási sérülések

- ▶ Viseljen védőkesztyűt.

### Követelmény:

-  A készüléket leválasztotta az áramellátásról.
-  Az ajtó nyitva van
-  Eltávolította a készülék felső szerelvényeit.

### 4.10.1 LED-világítás eltávolítása

1. Vigye a LED-világítást a bal oldalra.



-  Leválasztotta a LED-világítás elektromos csatlakozását.

2. Oldja ki a LED-világításhoz kapcsolódó horgokat.

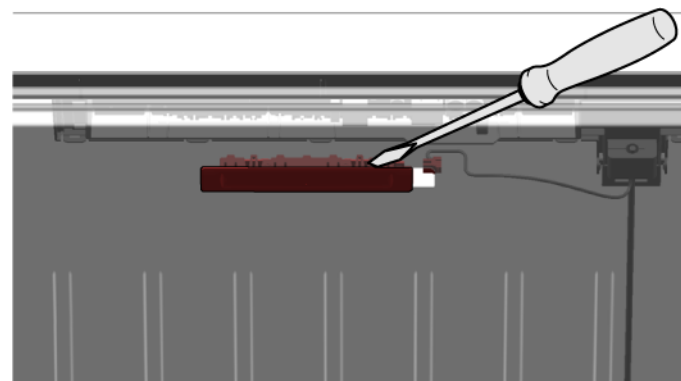



3. Emelje el a készüléktől a LED-világítást.

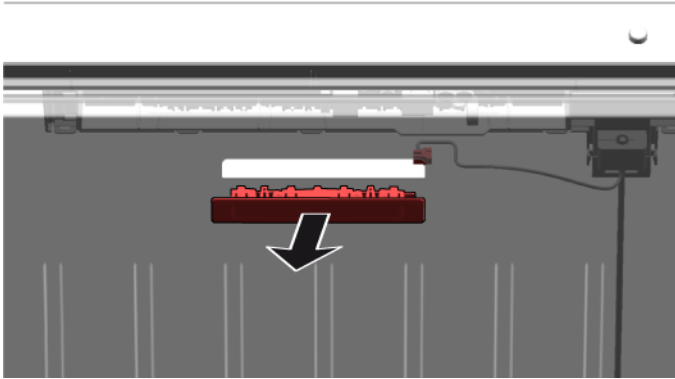

- ➔ Eltávolította a LED-világítást.

### 4.10.2 A felső LED-világítás beszerelése

- ▶ Az elhelyezést fordított sorrendben végezze.

# Consigli di riparazione - Congelatore

## **Utilizzo del documento** ..... 275

- 1.1 Avvertenze importanti ..... 275
  - 1.1.1 Scopo ..... 275
- 1.2 Spiegazione dei simboli ..... 275
  - 1.2.1 Livelli di pericolo ..... 275
  - 1.2.2 Simboli di pericolo ..... 275
  - 1.2.3 Struttura degli avvertimenti ..... 276
  - 1.2.4 Simboli generici ..... 276

## **Sicurezza** ..... 277

- 2.1 Note generali sulla sicurezza ..... 277
  - 2.1.1 Tutti gli elettrodomestici ..... 277

## **Strumenti e ausili** ..... 278

## **Riparazione** ..... 279

- 4.1 Sostituzione della guarnizione della porta ..... 279
  - 4.1.1 Smontaggio della guarnizione della porta ..... 279
  - 4.1.2 Montaggio della guarnizione della porta ..... 279
- 4.2 Sostituzione della maniglia della porta ..... 282
  - 4.2.1 Smontaggio della maniglia della porta ..... 282
  - 4.2.2 Montaggio della maniglia della porta ..... 282
- 4.3 Sostituzione della easy opening handle ..... 283
  - 4.3.1 Smontaggio della easy opening handle ..... 283
  - 4.3.2 Montaggio della easy opening handle ..... 283
- 4.4 Sostituzione della cerniera superiore della porta ..... 284
  - 4.4.1 Smontaggio della cerniera della porta ..... 284
  - 4.4.2 Montaggio della cerniera della porta ..... 286
- 4.5 Sostituzione della cerniera superiore della porta (porta con display) ..... 287
  - 4.5.1 Smontaggio della cerniera della porta ..... 288
  - 4.5.2 Montaggio della cerniera della porta ..... 289
- 4.6 Sostituzione della cerniera inferiore della porta ..... 290
  - 4.6.1 Sostituzione della cerniera inferiore della porta ..... 290
  - 4.6.2 Montaggio della cerniera inferiore della porta ..... 291
- 4.7 Sostituzione del ripiano ..... 292
  - 4.7.1 Smontaggio del ripiano ..... 292
  - 4.7.2 Montaggio del ripiano ..... 292

- 4.8 Sostituzione del cassetto surgelati ..... 293
  - 4.8.1 Rimozione del cassetto surgelati ..... 293
  - 4.8.2 Inserimento del cassetto surgelati ..... 293
- 4.9 Sostituzione del fabbricatore di ghiaccio ..... 294
  - 4.9.1 Smontaggio del fabbricatore di ghiaccio ..... 294
  - 4.9.2 Montaggio del fabbricatore di ghiaccio ..... 294
- 4.10 Sostituzione della luce a LED superiore ..... 295
  - 4.10.1 Smontaggio della luce a LED ..... 295
  - 4.10.2 Montaggio della luce a LED superiore ..... 296

# **i** Utilizzo del documento

## 1.1 Avvertenze importanti

### 1.1.1 Scopo

Queste istruzioni di riparazione spiegano ai clienti come riparare da soli gli elettrodomestici in conformità alle regole sull'Ecodesign vigenti (al 03/2021).

Contengono informazioni sulla sostituzione di pezzi di ricambio specifici e sulle avvertenze e i rischi correlati.

In caso di domande, contattare l'assistenza tecnica. Il mancato rispetto di tali istruzioni da parte dei clienti ci esonera da qualsiasi responsabilità.

## 1.2 Spiegazione dei simboli

### 1.2.1 Livelli di pericolo

I livelli di avvertimento corrispondono a un simbolo accompagnato da una parola di allerta. La parola di allerta identifica il livello di pericolo.





Livello di avvertimento	Significato
 <b>PERICOLO</b>	Ignorare questo messaggio di avvertimento comporta rischio di morte o ferite gravi.
 <b>AVVERTENZA</b>	Ignorare questo messaggio di avvertimento può comportare rischio di morte o ferite gravi.
 <b>ATTENZIONE</b>	Ignorare questo messaggio di avvertimento può comportare ferite di minore gravità.
 <b>ATTENZIONE!</b>	Ignorare questo messaggio di avvertimento può comportare danni materiali.

Tabella 1: Livelli di pericolo

### 1.2.2 Simboli di pericolo

I simboli di pericolo sono illustrazioni che specificano la tipologia di rischio.

Nella presente documentazione vengono utilizzati i seguenti simboli di pericolo:

Simbolo di pericolo	Significato
	Messaggio di avvertimento generico
	Pericolo di scossa elettrica
	Pericolo di esplosione
	Rischio di ferite da taglio

## Utilizzo del documento







Simbolo di pericolo	Significato
	Pericolo di schiacciamento
	Pericolo derivante da superfici calde
	Pericolo derivante da forti campi magnetici
	Pericolo derivante da radiazioni non ionizzanti

Tabella 2: Simboli di pericolo

### 1.2.3 Struttura degli avvertimenti

Gli avvertimenti presenti in questo manuale hanno una forma e una struttura standardizzati.

	<div style="background-color: red; color: white; padding: 2px; text-align: center;"> <b>PERICOLO</b></div> <p><b>Tipo e origine del pericolo!</b> Possibili conseguenze in caso di pericolo/avvertimento ignorato.</p> <ul style="list-style-type: none"> <li>▶ Misure e divieti volti a prevenire il pericolo.</li> </ul>
--	---

L'esempio seguente mostra un avvertimento con rischio di folgorazione dovuto a componenti sotto tensione. È riportata la misura di precauzione per evitare il pericolo.

	<div style="background-color: red; color: white; padding: 2px; text-align: center;"> <b>PERICOLO</b></div> <p><b>Rischio di scossa elettrica dovuto a componenti sotto tensione!</b> Morte per folgorazione</p> <ul style="list-style-type: none"> <li>▶ Scollegare l'apparecchio dall'alimentazione per almeno 60 secondi prima di iniziare la riparazione.</li> </ul>
--	--

### 1.2.4 Simboli generici

Nel presente manuale vengono utilizzati i seguenti simboli generici:



Simbolo generico	Significato
	Identificazione di un suggerimento speciale (testo e/o grafica)
	Identificazione di un suggerimento semplice (solo testo)
	Identificazione di un link per un video tutorial
	Identificazione degli strumenti necessari
	Identificazione delle condizioni preve necessarie
	Identificazione di una condizione (se ..., allora ...)
	Identificazione di un risultato
[Avvio]	Identificazione di un tasto o di un pulsante
[00123456]	Identificazione di un codice articolo
Stato	Identificazione di un testo/finestra visualizzati (sul display dell'apparecchio)

Tabella 3: Simboli generici

## 2.1 Note generali sulla sicurezza

### 2.1.1 Tutti gli elettrodomestici

#### **Rischio di scosse elettriche dovute a componenti sotto tensione!**

- La riparazione non conforme dei componenti elettrici può causare scosse elettriche!
- Scollegare l'apparecchio dall'alimentazione per almeno 60 secondi prima di iniziare il lavoro.
- Ultimata la riparazione, occorre eseguire un test di sicurezza conforme alla norma VDE 0701 o alle norme specifiche del Paese.

#### **Rischio di lesioni causate da bordi taglienti!**

- Indossare guanti di protezione.

#### **Rischio di schiacciamento dovuto a componenti pesanti e in movimento durante la riparazione, la manutenzione, la ricerca dei guasti e l'assistenza**

- Indossare calzature antinfortunistiche.
- Fissare i componenti pesanti per impedire che cadano.
- Non inserire parti del corpo nei componenti in movimento.



#### **Rischio per il funzionamento o la sicurezza dell'apparecchio!**

- Utilizzare solo ricambi originali.

#### **Rischio di danneggiamento di componenti sensibili a carica elettrostatica (ESD)!**

- Non toccare i moduli, inclusi i collegamenti e le piste conduttive.

## Strumenti e ausili

Designazione	Dettagli	Immagini
Panno di protezione [00342013]	60 cm x 50 cm	
Cacciavite Phillips (a croce) PH2		
Punta Torx TX20 [00340865]	6,3 mm (1/4")	
Cacciavite a taglio	Lama 2,4 mm x 0,4 mm x 60 mm, nel kit [00341820]	

## 4.1 Sostituzione della guarnizione della porta

### Prerequisiti:

- ✔ La porta è aperta.

### 4.1.1 Smontaggio della guarnizione della porta

1. Staccare la guarnizione della porta dalla scanalatura negli angoli destro e sinistro.



2. Estrarre la guarnizione della porta dalla scanalatura.



- ➡ La guarnizione della porta è rimossa.

### 4.1.2 Montaggio della guarnizione della porta



Lo spessore della nuova guarnizione della porta può essere leggermente diverso dallo spessore di quella vecchia. Ciò non incide sulla chiusura e sul funzionamento a lungo termine.



Se l'apparecchio è dotato di cerniere regolabili o accessori, è possibile ottimizzare il comportamento di chiusura.



I piccoli fori laterali nella guarnizione della porta sono funzionali (necessari per la ventilazione). Non si tratta di difetti di produzione.

## Riparazione

1. Controllare che la scanalatura della guarnizione non sia danneggiata.

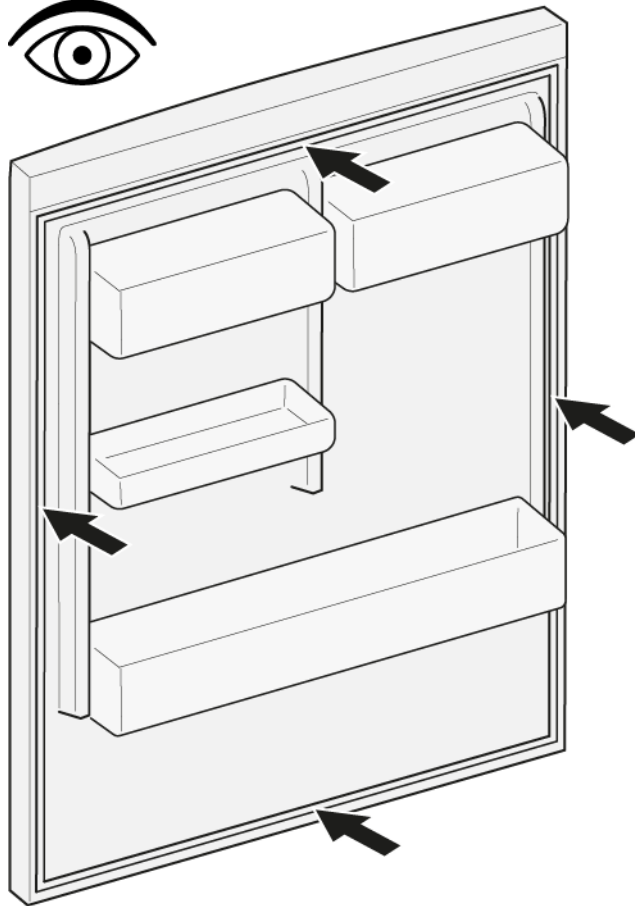

4. Spingere gli angoli della guarnizione nella scanalatura in alto e in basso.

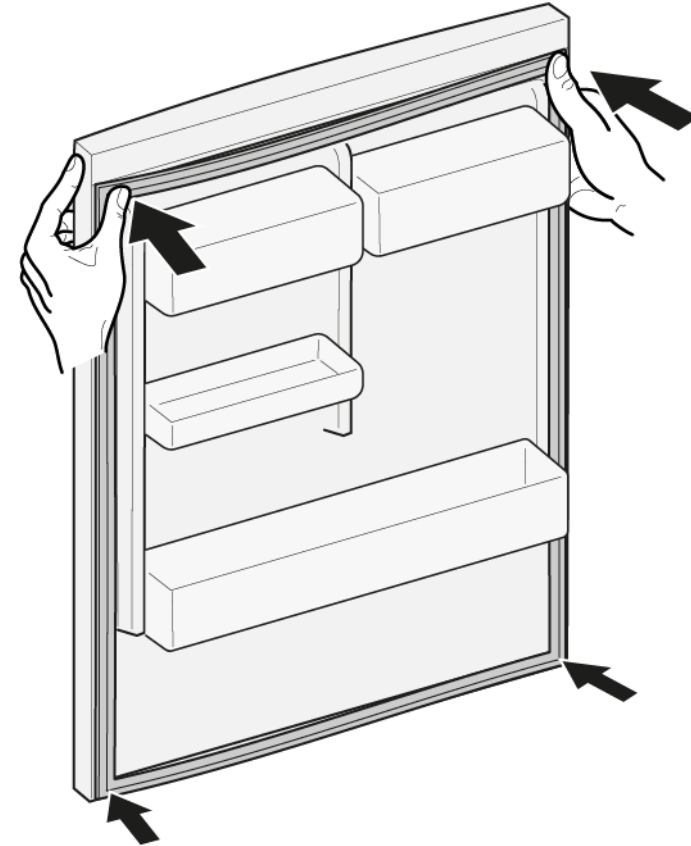

2.  Se la scanalatura della guarnizione è danneggiata.  
- Contattare l'assistenza tecnica.

3.  Una leggera deformazione della guarnizione della porta è normale e non incide sul funzionamento. Si consiglia di raddrizzare la guarnizione della porta prima di inserirla nell'apparecchio.

Riscaldare la guarnizione della porta con un asciugacapelli o acqua calda e ridarle la forma manualmente.



## Riparazione



5. Premere la guarnizione nella scanalatura un pezzo per volta.





-  La guarnizione della porta è montata.

## 4.2 Sostituzione della maniglia della porta

### Attrezzi speciali:

-  Punta Torx TX20                      6,3 mm (1/4")                      [00340865]
-  Cacciavite a taglio                      Lama 10 mm x 1,6 mm x 200 mm

### Prerequisiti:

-  L'apparecchio è scollegato dalla rete elettrica.
-  La porta è aperta.

### 4.2.1 Smontaggio della maniglia della porta

- ▶ 1. Togliere i due tappi delle viti (1).
- ▶ 2. Svitare le due viti (2).
- ▶ 3. Smontare la maniglia della porta (3).

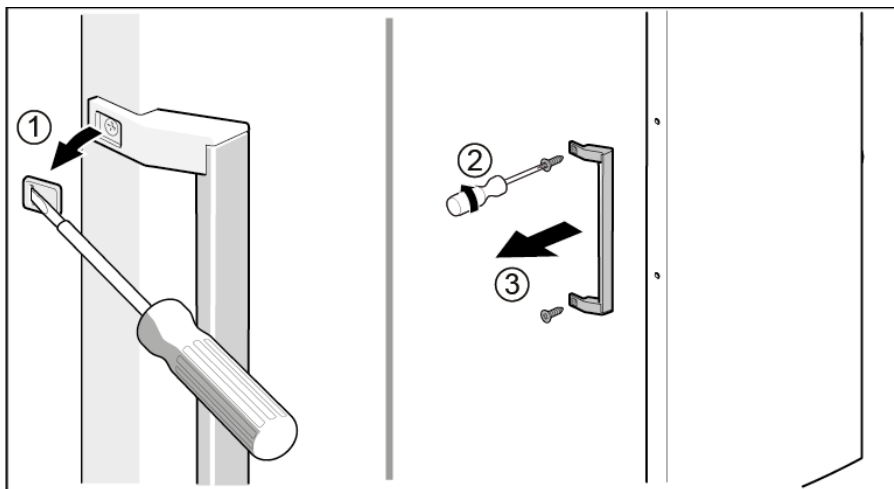

-  La maniglia della porta è rimossa.

### 4.2.2 Montaggio della maniglia della porta



- ▶ Per il montaggio, seguire la procedura sopra descritta in senso opposto.

## 4.3 Sostituzione della easy opening handle

### Attrezzi speciali:

-  Cacciavite Phillips (a croce) PH2

### Prerequisiti:

-  L'apparecchio è scollegato dalla rete elettrica.
-  La porta è aperta.

### 4.3.1 Smontaggio della easy opening handle

- ▶ 1. Togliere la copertura della easy opening handle (1).
- ▶ 2. Svitare le due viti (2).

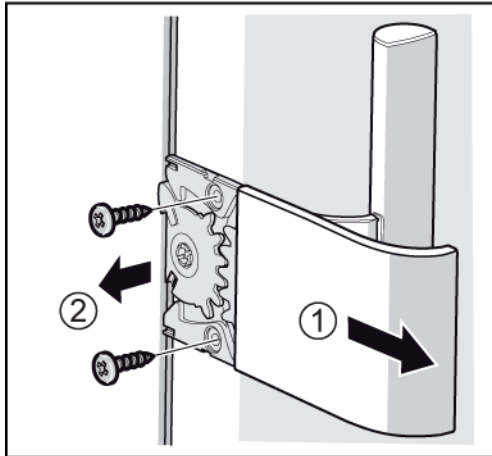

 La easy opening handle è rimossa.

## 4.3.2 Montaggio della easy opening handle

Il meccanismo della easy opening handle deve essere regolato correttamente prima del montaggio.

La disposizione corretta dell'asta di spinta (1), dei quadranti dentati (2) e (3), della molla (4) e del finecorsa (5) per il montaggio della porta sul lato sinistro è mostrata nella figura.

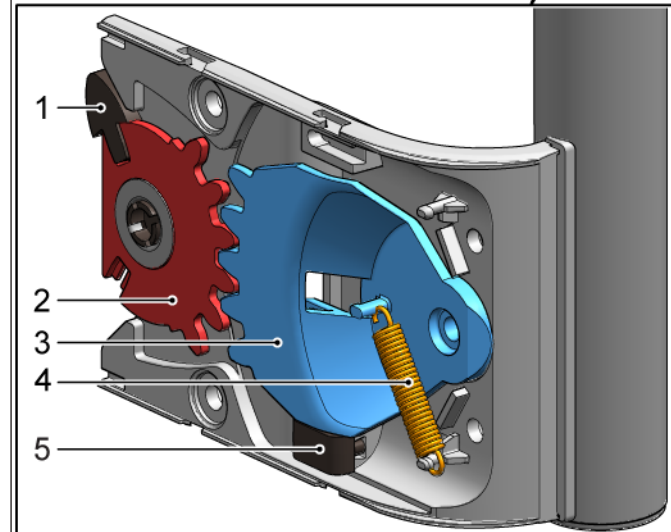
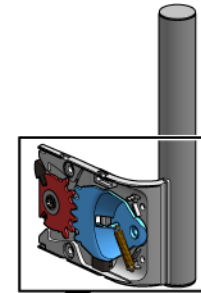



La disposizione dei sottocomponenti della easy opening handle per il montaggio della porta a destra è descritto nel documento "Istruzioni di installazione".

- ▶ Per il montaggio, seguire la procedura sopra descritta in senso opposto.

## 4.4 Sostituzione della cerniera superiore della porta

### Attrezzi speciali:

 Punta Torx TX20      6,3 mm (1/4")      [00340865]

	<b>AVVERTENZA</b>
	<b>Apparecchi pesanti, ingombranti!</b> Rischio di infortuni muscolari e alla schiena <ul style="list-style-type: none"><li>▶ L'operazione di smontaggio della porta dell'apparecchio deve essere eseguita soltanto da tecnici addestrati.</li><li>▶ Spostare l'apparecchio in due persone.</li><li>▶ Usare solo utensili e attrezzature idonei.</li></ul>

	<b>ATTENZIONE</b>
	<b>Bordi taglienti!</b> Ferite da taglio <ul style="list-style-type: none"><li>▶ Indossare guanti di protezione.</li></ul>

	<b>AVVERTENZA</b>
	<b>Gli apparecchi inclinati possono scivolare!</b> Fratture / lesioni da schiacciamento <ul style="list-style-type: none"><li>▶ Fissare gli apparecchi in modo che non scivolino.</li></ul>

	<b>ATTENZIONE</b>
	<b>Rischio di caduta di componenti a causa di viti allentate!</b> Lesioni provocate dalla caduta di componenti. <ul style="list-style-type: none"><li>▶ Fissare i componenti in modo che non cadano.</li></ul>

	<b>ATTENZIONE!</b>
	<b>Rischio di caduta di componenti a causa di viti allentate!</b> Danni a altre parti dell'apparecchio o all'abitazione del cliente, ad es. parte inferiore. <ul style="list-style-type: none"><li>▶ Fissare i componenti in modo che non cadano.</li></ul>

### Prerequisiti:

- ✓ L'apparecchio è scollegato dalla rete elettrica.
- ✓ Gli accessori interni dell'apparecchio sono stati rimossi.

## 4.4.1 Smontaggio della cerniera della porta

## Riparazione

1. Coricare l'apparecchio sul retro.

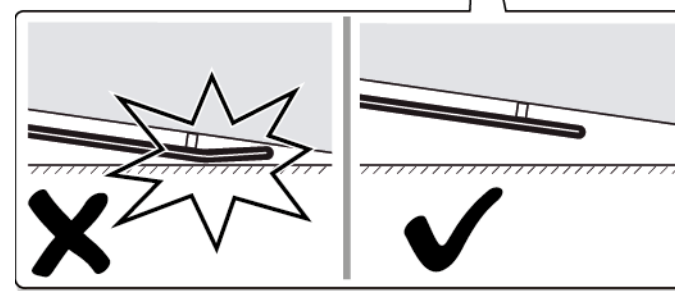
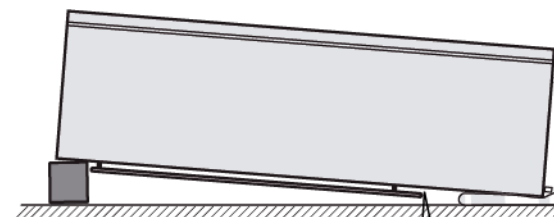
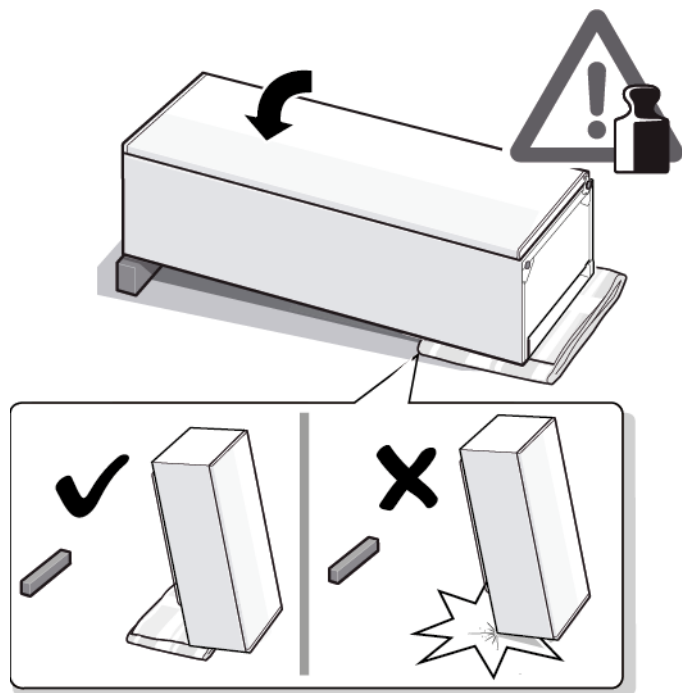

2.
  1. Premere la copertura della cerniera superiore su entrambi i lati (1).
  2. Tirare la copertura della cerniera superiore verso l'esterno (2).
  3. Togliere la copertura della cerniera superiore (3).

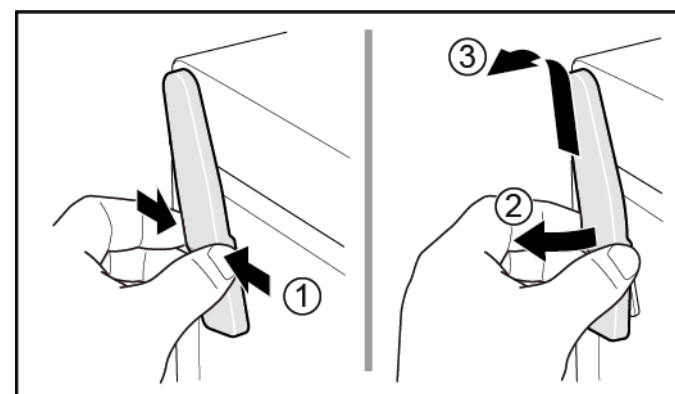

## Riparazione

3.
  1. Svitare le due viti (1).
  2. Togliere la cerniera superiore (2).

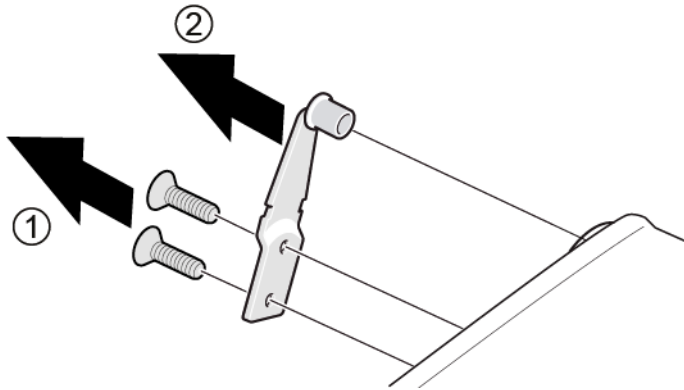

 La cerniera superiore della porta è rimossa.

### 4.4.2 Montaggio della cerniera della porta

- ▶ Per il montaggio, seguire la procedura sopra descritta in senso opposto.

## 4.5 Sostituzione della cerniera superiore della porta (porta con display)

### Attrezzi speciali:

 Punta Torx TX20      6,3 mm (1/4")      [00340865]

	<b>⚠ AVVERTENZA</b>
	<p><b>Apparecchi pesanti, ingombranti!</b> Rischio di infortuni muscolari e alla schiena</p> <ul style="list-style-type: none"> <li>▶ L'operazione di smontaggio della porta dell'apparecchio deve essere eseguita soltanto da tecnici addestrati.</li> <li>▶ Spostare l'apparecchio in due persone.</li> <li>▶ Usare solo utensili e attrezzature idonei.</li> </ul>

	<b>⚠ ATTENZIONE</b>
	<p><b>Bordi taglienti!</b> Ferite da taglio</p> <ul style="list-style-type: none"> <li>▶ Indossare guanti di protezione.</li> </ul>

	<b>⚠ AVVERTENZA</b>
	<p><b>Gli apparecchi inclinati possono scivolare!</b> Fratture / lesioni da schiacciamento</p> <ul style="list-style-type: none"> <li>▶ Fissare gli apparecchi in modo che non scivolino.</li> </ul>



	<b>⚠ ATTENZIONE</b>
	<p><b>Rischio di caduta di componenti a causa di viti allentate!</b> Lesioni provocate dalla caduta di componenti.</p> <ul style="list-style-type: none"> <li>▶ Fissare i componenti in modo che non cadano.</li> </ul>

	<b>ATTENZIONE!</b>
	<p><b>Rischio di caduta di componenti a causa di viti allentate!</b> Danni a altre parti dell'apparecchio o all'abitazione del cliente, ad es. parte inferiore.</p> <ul style="list-style-type: none"> <li>▶ Fissare i componenti in modo che non cadano.</li> </ul>

	<b>⚠ PERICOLO</b>
	<p><b>Rischio di scosse elettriche dovute a componenti sotto tensione!</b> Pericolo di morte dovuto a scosse elettriche in caso di riparazione non conforme</p> <ul style="list-style-type: none"> <li>▶ Le parti elettriche devono essere riparate da elettricisti qualificati.</li> <li>▶ Ultimata la riparazione, occorre eseguire un test di sicurezza conforme alla norma VDE 0701 o alle norme specifiche del Paese.</li> </ul>

	<b>⚠ PERICOLO</b>
	<p><b>Rischio di scossa elettrica dovuto a componenti sotto tensione!</b> Morte per folgorazione</p> <ul style="list-style-type: none"> <li>▶ Scollegare l'apparecchio dall'alimentazione per almeno 60 secondi prima di iniziare la riparazione.</li> </ul>

### Prerequisiti:

-  L'apparecchio è scollegato dalla rete elettrica.
-  Gli accessori interni dell'apparecchio sono stati rimossi.

## 4.5.1 Smontaggio della cerniera della porta

1. Coricare l'apparecchio sul retro.

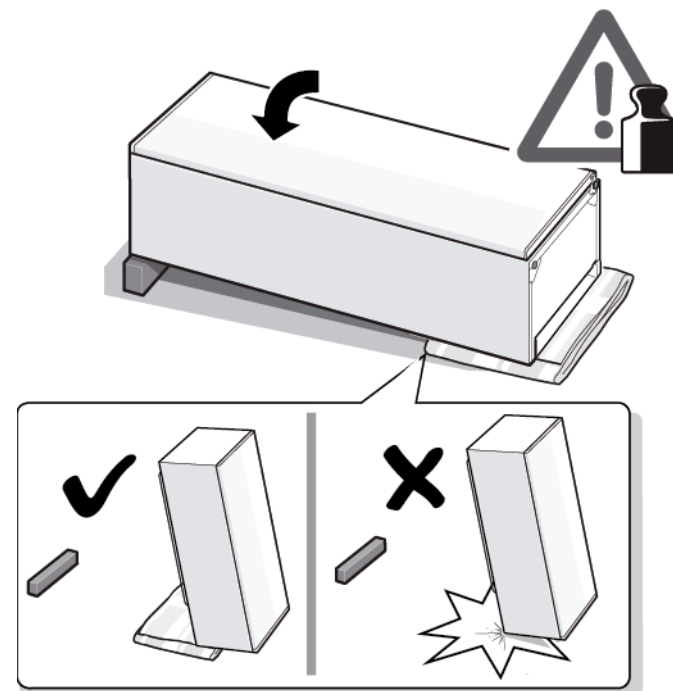



## Riparazione

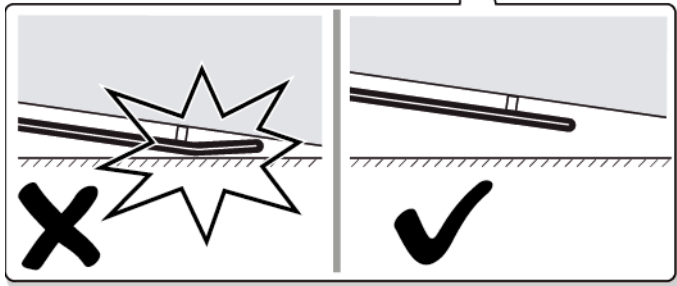
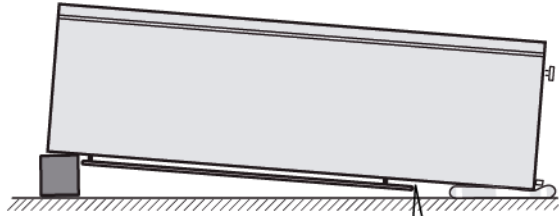

1. Premere la copertura della cerniera superiore su entrambi i lati (1).
2. Tirare la copertura della cerniera superiore verso l'esterno (2).
3. Togliere la copertura della cerniera superiore (3).

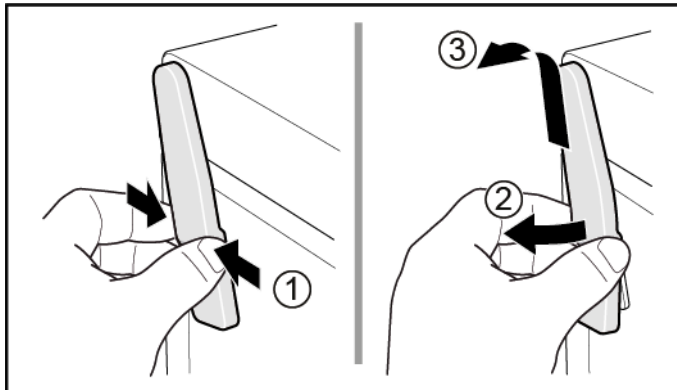

1. Togliere il coperchio del cavo (1).
2. Togliere la protezione del cavo (2).
3. Staccare il collegamento elettrico (3).
4. Svitare le due viti (4).
5. Togliere la cerniera superiore (5).

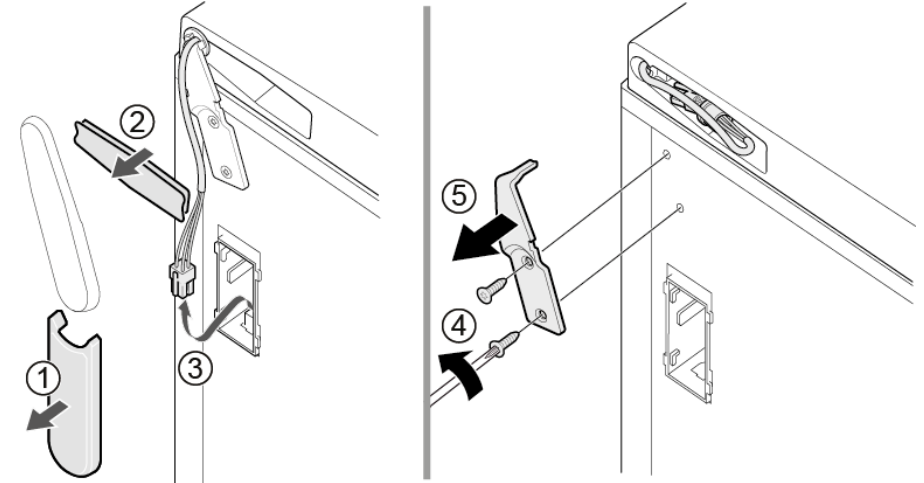

➡ La cerniera superiore della porta è rimossa.

### 4.5.2 Montaggio della cerniera della porta

- ▶ Per il montaggio, seguire la procedura sopra descritta in senso opposto.

## 4.6 Sostituzione della cerniera inferiore della porta

### Attrezzi speciali:

 Punta Torx TX20      6,3 mm (1/4")      [00340865]

	<b>⚠ AVVERTENZA</b>
	<p><b>Apparecchi pesanti, ingombranti!</b>          Rischio di infortuni muscolari e alla schiena</p> <ul style="list-style-type: none"> <li>▶ L'operazione di smontaggio della porta dell'apparecchio deve essere eseguita soltanto da tecnici addestrati.</li> <li>▶ Spostare l'apparecchio in due persone.</li> <li>▶ Usare solo utensili e attrezzature idonei.</li> </ul>



	<b>⚠ ATTENZIONE</b>
	<p><b>Bordi taglienti!</b>          Ferite da taglio</p> <ul style="list-style-type: none"> <li>▶ Indossare guanti di protezione.</li> </ul>

	<b>⚠ AVVERTENZA</b>
	<p><b>Gli apparecchi inclinati possono scivolare!</b>          Fratture / lesioni da schiacciamento</p> <ul style="list-style-type: none"> <li>▶ Fissare gli apparecchi in modo che non scivolino.</li> </ul>

	<b>⚠ ATTENZIONE</b>
	<p><b>Rischio di caduta di componenti a causa di viti allentate!</b>          Lesioni provocate dalla caduta di componenti.</p> <ul style="list-style-type: none"> <li>▶ Fissare i componenti in modo che non cadano.</li> </ul>

	<b>ATTENZIONE!</b>
	<p><b>Rischio di caduta di componenti a causa di viti allentate!</b>          Danni a altre parti dell'apparecchio o all'abitazione del cliente, ad es. parte inferiore.</p> <ul style="list-style-type: none"> <li>▶ Fissare i componenti in modo che non cadano.</li> </ul>

### Prerequisiti:

-  L'apparecchio è scollegato dalla rete elettrica.
-  Gli accessori interni dell'apparecchio sono stati rimossi.
-  L'apparecchio è coricato sul retro.

 [La cerniera superiore è rimossa. →287](#)

### 4.6.1 Sostituzione della cerniera inferiore della porta

1. Smontare la porta.

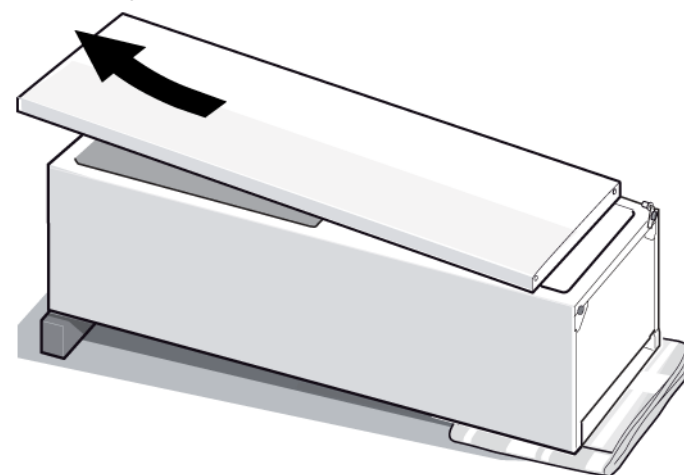

2.
  1. Svitare la vite (1).
  2. Ruotare la cerniera inferiore verso l'esterno (2).
  3. Togliere la cerniera inferiore (3).

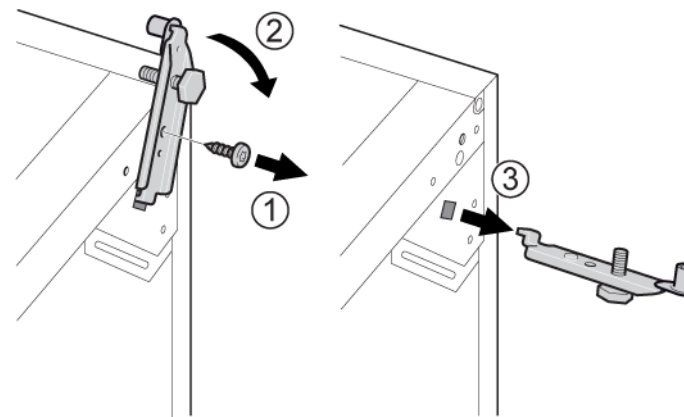

 La cerniera inferiore è rimossa.

### 4.6.2 Montaggio della cerniera inferiore della porta

- ▶ Per il montaggio, seguire la procedura sopra descritta in senso opposto.

## 4.7 Sostituzione del ripiano

### Prerequisiti:

- ✔ La porta è aperta.

### 4.7.1 Smontaggio del ripiano

- ▶ Estrarre il ripiano.



➡ Il ripiano è rimosso.

### 4.7.2 Montaggio del ripiano

- ▶ Per il montaggio, seguire la procedura sopra descritta in senso opposto.

## 4.8 Sostituzione del cassetto surgelati

### Prerequisiti:

- ✔ La porta è aperta.

### 4.8.1 Rimozione del cassetto surgelati

- ▶ 1. Estrarre completamente il cassetto surgelati (1).
- ▶ 2. Togliere il cassetto surgelati (2).

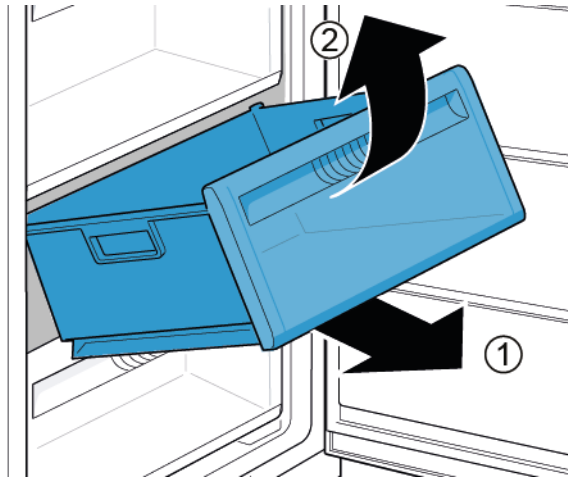

- ➡ Il cassetto surgelati è rimosso.

### 4.8.2 Inserimento del cassetto surgelati

- ▶ Per il montaggio, seguire la procedura sopra descritta in senso opposto.

## 4.9 Sostituzione del fabbricatore di ghiaccio

### Prerequisiti:

- ✔ La porta è aperta.

### 4.9.1 Smontaggio del fabbricatore di ghiaccio

- ▶ 1. Estrarre il cassetto surgelati con il fabbricatore di ghiaccio (1).
- ▶ 2. Sbloccare i fermi (2).
- ▶ 3. Rimuovere il fabbricatore di ghiaccio (3).

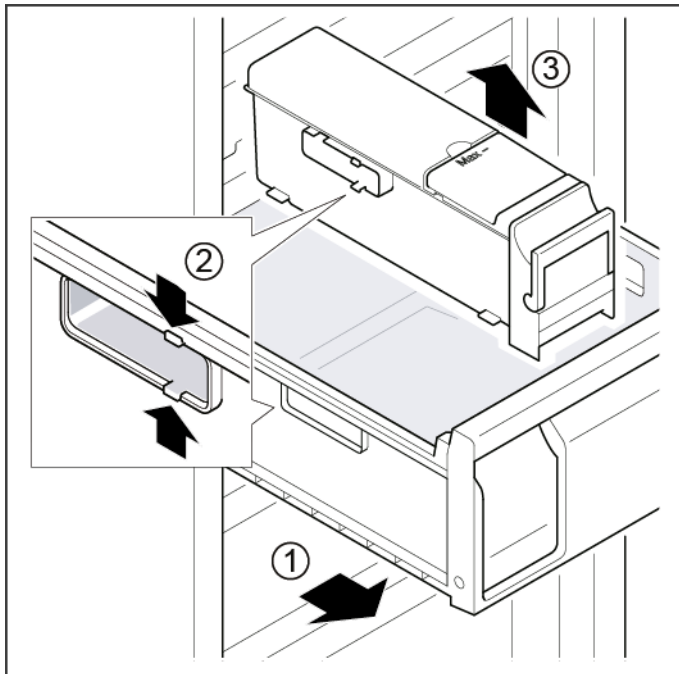

➡ Il fabbricatore di ghiaccio è rimosso.

### 4.9.2 Montaggio del fabbricatore di ghiaccio

- ▶ Per il montaggio, seguire la procedura sopra descritta in senso opposto.

## 4.10 Sostituzione della luce a LED superiore

### Attrezzi speciali:

-  Cacciavite a taglio      Lama 2,4 mm x 0,4 mm x 60 mm, nel kit [00341820]

 L'apparecchio è dotato di una luce a LED esente da manutenzione. Queste luci possono essere riparate esclusivamente dall'assistenza tecnica o da tecnici autorizzati!

 **PERICOLO**  
**Rischio di scosse elettriche dovute a componenti sotto tensione!**  
 Pericolo di morte dovuto a scosse elettriche in caso di riparazione non conforme

- ▶ Le parti elettriche devono essere riparate da elettricisti qualificati.
- ▶ Ultimata la riparazione, occorre eseguire un test di sicurezza conforme alla norma VDE 0701 o alle norme specifiche del Paese.



 **PERICOLO**  
**Rischio di scossa elettrica dovuto a componenti sotto tensione!**  
 Morte per folgorazione

- ▶ Scollegare l'apparecchio dall'alimentazione per almeno 60 secondi prima di iniziare la riparazione.

 **ATTENZIONE**  
**Bordi taglienti!**  
 Ferite da taglio

- ▶ Indossare guanti di protezione.

### Prerequisiti:

-  L'apparecchio è scollegato dalla rete elettrica.
-  La porta è aperta.
-  Gli accessori interni superiori sono stati rimossi.

### 4.10.1 Smontaggio della luce a LED

1. Spostare la luce a LED sul lato sinistro.

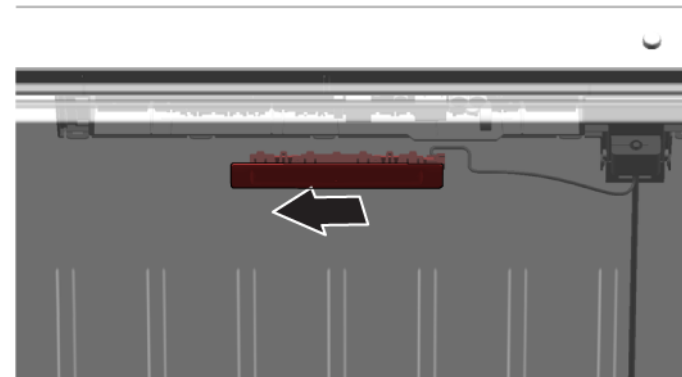

-  Il collegamento elettrico della luce a LED è scollegato.

2. Sbloccare i fermi della luce a LED.

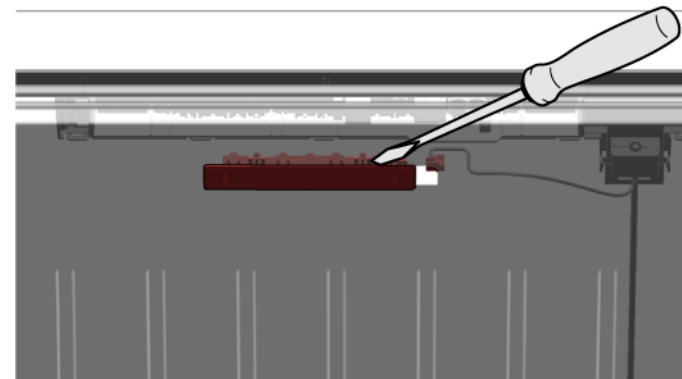

3. Togliere la luce a LED spostandola in avanti.

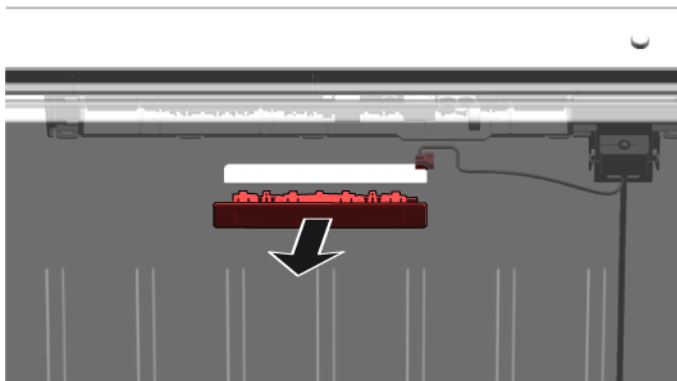



- ➡ La luce LED è rimossa.

### 4.10.2 Montaggio della luce a LED superiore

- ▶ Per il montaggio, seguire la procedura sopra descritta in senso opposto.



# Informācija par remontu - Saldētava

 <b>Par šo dokumentu</b> .....	<b>298</b>
1.1 Būtiska informācija .....	298
1.1.1 Mērķis .....	298
1.2 Simbolu skaidrojums.....	298
1.2.1 Bīstamības līmeņi .....	298
1.2.2 Bīstamības simboli .....	298
1.2.3 Brīdinājumu struktūra .....	299
1.2.4 Vispārīgie simboli.....	299
 <b>Drošība</b> .....	<b>300</b>
2.1 Vispārējie drošības norādījumi .....	300
2.1.1 Visām mājsaimniecības ierīcēm .....	300
 <b>Piederumi un palīgļīdzekļi</b> .....	<b>301</b>
 <b>Remonts</b> .....	<b>302</b>
4.1 Durvju blīvslēga nomaiņa .....	302
4.1.1 Durvju blīvslēga noņemšana .....	302
4.1.2 Durvju blīvslēga uzstādīšana .....	302
4.2 Durvju roktura nomaiņa.....	305
4.2.1 Durvju roktura noņemšana.....	305
4.2.2 Durvju roktura uzstādīšana .....	305
4.3 Easy opening handle (ērtās atvēršanas roktura) nomaiņa .....	306
4.3.1 Easy opening handle (ērtās atvēršanas roktura) noņemšana .....	306
4.3.2 Easy opening handle (ērtās atvēršanas roktura) uzstādīšana .....	306
4.4 Durvju augšējās viras nomaiņa.....	307
4.4.1 Durvju viras noņemšana .....	307
4.4.2 Durvju viras uzstādīšana .....	309
4.5 Durvju augšējās viras nomaiņa (durvis ar displeju) .....	310
4.5.1 Durvju viras noņemšana .....	311
4.5.2 Durvju viras uzstādīšana .....	312
4.6 Durvju apakšējās viras nomaiņa .....	313
4.6.1 Durvju apakšējās viras nomaiņa.....	313
4.6.2 Durvju apakšējās viras uzstādīšana .....	313
4.7 Plaukta nomaiņa.....	314
4.7.1 Plaukta izņemšana .....	314
4.7.2 Plaukta uzstādīšana .....	314

4.8 Saldētās pārtikas tvertnes nomaiņa.....	315
4.8.1 Saldētās pārtikas tvertnes izņemšana .....	315
4.8.2 Saldētās pārtikas tvertnes uzstādīšana .....	315
4.9 Ledus tvertnes nomaiņa .....	316
4.9.1 Ledus tvertnes izņemšana .....	316
4.9.2 Ledus tvertnes uzstādīšana.....	316
4.10 Augšējā LED gaismekļa nomaiņa.....	317
4.10.1 LED gaismekļa noņemšana.....	317
4.10.2 Augšējā LED gaismekļa uzstādīšana .....	318

# **i** Par šo dokumentu

## 1.1 Būtiska informācija

### 1.1.1 Mērķis

Šie labošanas ieteikumi ir paredzēti patērētājam, patstāvīgi labojot ierīces, saskaņā ar piemērojamo Ekodizaina regulu (sākot no 03.2021.).

Tajā ir sniegta informācija par to, kā nomainīt noteiktas rezerves daļas, kā arī brīdinājumi un riski.

Jautājumu gadījumā lūdzam sazināties ar mūsu klientu apkalpošanas dienestu. Mēs esam atbildīgi par zaudējumiem tikai tad, ja ir pienācīgi ievēroti šie labošanas ieteikumi.

## 1.2 Simbolu skaidrojums

### 1.2.1 Bīstamības līmeņi

Brīdinājuma līmeņus veido simbols un signālvārds. Signālvārds apzīmē bīstamības pakāpi.





Brīdinājuma līmenis	Nozīme
 <b>BĪSTAMI</b>	Brīdinājuma paziņojuma neievērošanas rezultātā iestāsies nāve vai radīsies smagas traumas.
 <b>BRĪDINĀJUMS</b>	Brīdinājuma paziņojuma neievērošanas rezultātā var iestāties nāve vai rasties smagas traumas.
 <b>ESJET PIESARDŽĪGI</b>	Brīdinājuma paziņojuma neievērošanas rezultātā var rasties nelielas traumas.
 <b>UZMANĪBU!</b>	Brīdinājuma paziņojuma neievērošanas rezultātā var rasties kaitējums īpašumam.

Tabula 1: Bīstamības līmeņi



### 1.2.2 Bīstamības simboli

Bīstamības simboli ir simboliski apzīmējumi, kas sniedz norādes par bīstamības veidu.

Šajā dokumentā ir izmantoti šādi bīstamības simboli:

Bīstamības simbols	Nozīme
	Vispārējs brīdinājuma paziņojums
	Elektriskā sprieguma radīts apdraudējums
	Sprādzienbīstamības risks
	Griezumu bīstamība
	Saspiešanas bīstamība

## **i** Par šo dokumentu

Bīstamības simbols	Nozīme
	Karstu virsmu radīta bīstamība
	Spēcīgu magnētisko lauku radīta bīstamība
	Nejonizējoša starojuma radīta bīstamība

Tabula 2: Bīstamības simboli

### 1.2.3 Brīdinājumu struktūra

Šajā dokumentā sniegtajiem brīdinājumiem ir standartizēts noformējums un standartizēta struktūra.



	<div style="background-color: red; color: white; padding: 2px; text-align: center;"><b>⚠ BĪSTAMI</b></div> <p><b>Bīstamības veids un avots!</b> Iespējamās sekas, kas rodas, neievērojot bīstamības paziņojumu / brīdinājumu.</p> <ul style="list-style-type: none"> <li>▶ Bīstamības novēršanas pasākumi un aizliegumi.</li> </ul>
--	---





Nākamajā piemērā ir parādīts brīdinājums, kas apzīmē elektrotrieciena risku, ko rada spriegumaktīvas detaļas. Ir norādīts bīstamības novēršanas pasākums.

	<div style="background-color: red; color: white; padding: 2px; text-align: center;"><b>⚠ BĪSTAMI</b></div> <p><b>Elektrotrieciena risks, ko rada spriegumaktīvas detaļas!</b> Nāvējošs elektrotrieciens</p> <ul style="list-style-type: none"> <li>▶ Atvienojiet iekārtas no strāvas padeves vismaz 60 sekundes pirms labošanas sākšanas.</li> </ul>
--	--

### 1.2.4 Vispārīgie simboli

Šajā dokumentā ir izmantoti šādi vispārīgie simboli:

Visp. simbols	Nozīme
	Īpašu ieteikumu apzīmējums (teksts un/ vai grafika)
	Vienkāršu ieteikumu apzīmējums (tikai teksts)

Visp. simbols	Nozīme
	Video pamācības saites apzīmējums
	Nepieciešamo rīku apzīmējums
	Nepieciešamo priekšnosacījumu apzīmējums
	Nosacījuma apzīmējums (ja ..., tad ...)
	Rezultāta apzīmējums
[Sākt]	Taustiņa vai pogas apzīmējums
[00123456]	Materiāla numura apzīmējums
Statuss	Attēlotā teksta / loga apzīmējums (iekārtas displejā)

Tabula 3: Vispārīgie simboli

## 2.1 Vispārējie drošības norādījumi

### 2.1.1 Visām mājsaimniecības ierīcēm

#### **Elektrotrieciena risks spriegumaktīvu daļu dēļ!**

- Ja remonts, kas skar elektriskās daļas, ir veikts kļūdaini, pastāv elektrotrieciena risks!
- Ierīcei ir jābūt atvienotai no tīkla vismaz 60 sekundes, pirms sāk darbu.
- Pēc remonta ierīces drošība ir jāpārbauda atbilstīgi noteikumiem VDE 0701 vai valsts noteikumiem.

#### **Savainojumu risks asu malu dēļ!**

- Valkājiet aizsargcimdus.

#### **Saspiešanas risks labošanas, uzturēšanas, traucējumu novēršanas un apkopes laikā, ko rada smagas un kustīgas detaļas**

- Valkājiet aizsargapavus.
- Nostipriniet smagas detaļas, lai tās nenokristu.
- Neievietojiet ķermeņa daļas kustīgās detaļās.



#### **Ierīces drošības / darbības traucējuma risks!**

- Izmantojiet tikai oriģinālās rezerves daļas.

#### **Pret elektrostatisko izlādi jutīgu daļu (ESDS) bojājuma risks!**

- Neaiztieciet moduļus, ieskaitot savienojumus un vadojumu.

## Piederumi un palīglīdzekļi

Apzīmējums	Sīkāka informācija	Attēli
Aizsargdrāna [00342013]	60 cm x 50 cm	
Phillips skrūvgriezis PH2		
Torx uzgalis TX20 [00340865]	6,3 mm (1/4")	
Plakanais skrūvgriezis	Izmērs: 2,4 mm x 0,4 mm x 60 mm, komplektā [00341820]	

## 4.1 Durvju blīvslēga nomaīņa

### Prasība:

- ✓ Durvīm ir jābūt atvērtām.

### 4.1.1 Durvju blīvslēga noņemšana

1. Atbrīvojiet durvju blīvslēgu no rievas labajā un kreisajā pusē.



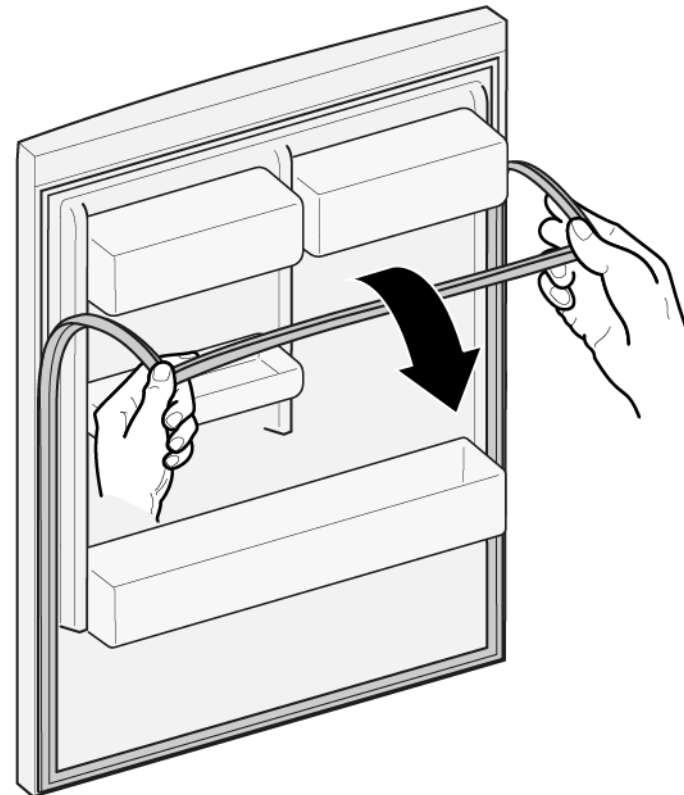

2. Izvelciet durvju blīvslēgu no rievas.



- ➡ Durvju blīvslēgs ir noņemts.

### 4.1.2 Durvju blīvslēga uzstādīšana

	Jaunā durvju blīvslēga biezums var mazliet atšķirties no vecā durvju blīvslēga biezuma. Tas neietekmē aizvēršanos un darbību ilgtermiņā.
	Ja ierīces viras var regulēt vai tai ir viru savienojumi, vēlāk aizvēršanos var pielāgot.
	Mazie caurumi durvju blīvslēga sānos ir funkcionāli (nodrošina ventilāciju). Tie nav ražošanas defekti.

1. Pārbaudiet, ka blīvslēga rieta nav bojāta.

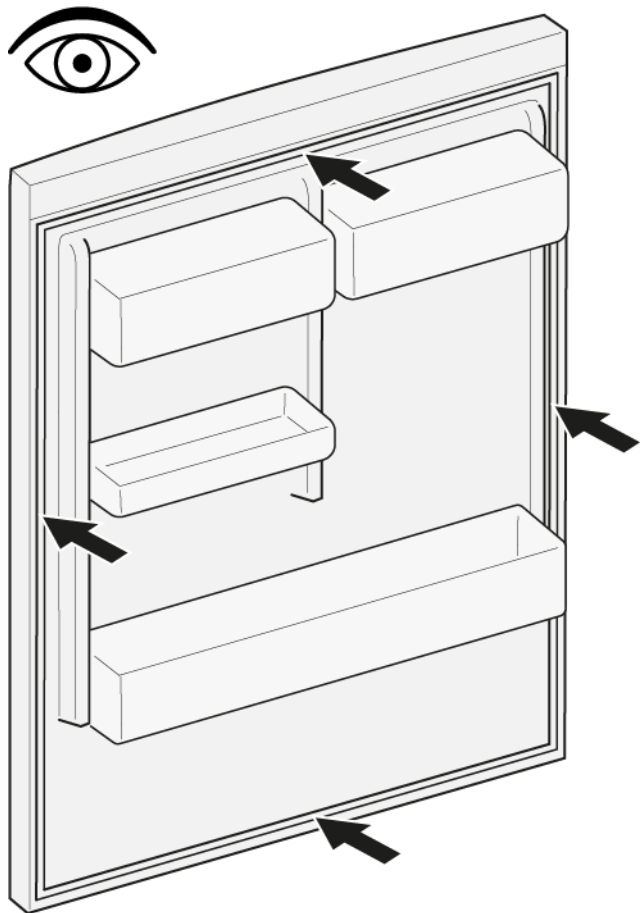

2. ⓘ Ja blīvslēga rieta ir bojāta  
- Sazinieties ar klientu apkalpošanas dienesta pārstāvi.

3. ⓘ Durvju blīvslēgs var būt mazliet deformējies, kas neietekmē tā darbību. Pirms durvju blīvslēgu ieliek ierīcē, to ir ieteicams iztaisnot.

Sasildiet durvju blīvslēgu ar matu fēnu vai karstā ūdenī un ar rokām atjaunojiet tā formu.

4. Iespiediet blīvslēga augšējos un apakšējos stūrus rieta.

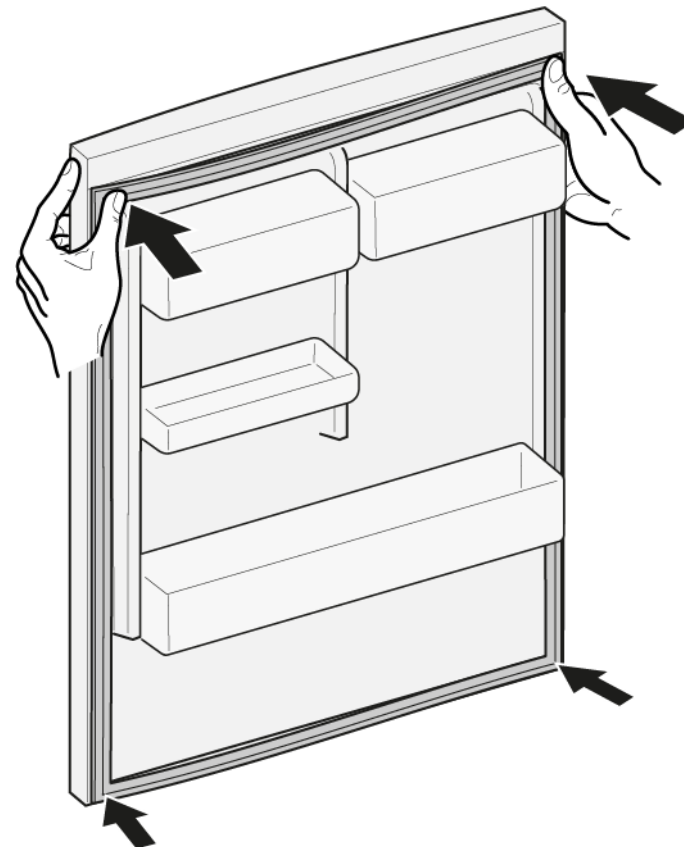

5. Pakāpeniski iespiediet visu blīvslēgu rievā.

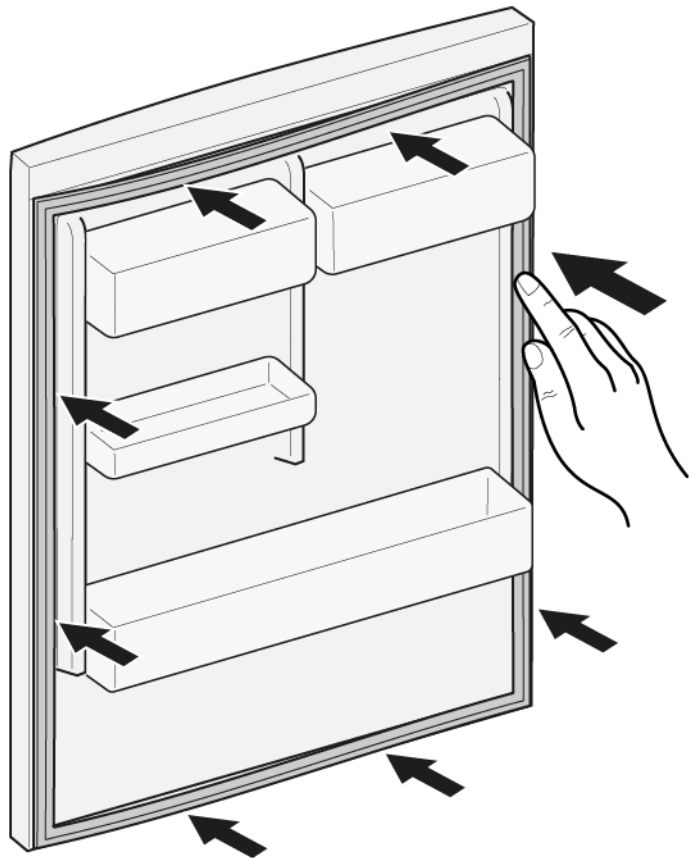



 Durvju blīvslēgs ir uzstādīts.





## 4.2 Durvju roktura nomaiņa

### Speciāli rīki:

-  Torx uzgalis TX20                      6,3 mm (1/4")                      [00340865]
-  Plakanais skrūvgriezis                      Izmērs: 10 mm x 1,6 mm x 200 mm

### Prasība:

-  Ierīces elektropadevei ir jābūt atvienotai.
-  Durvīm ir jābūt atvērtām.

### 4.2.1 Durvju roktura noņemšana

- ▶ 1. Noņemiet abu skrūvju vāciņus (1).
- ▶ 2. Izskrūvējiet abas skrūves (2).
- ▶ 3. Noņemiet durvju rokturi (3).

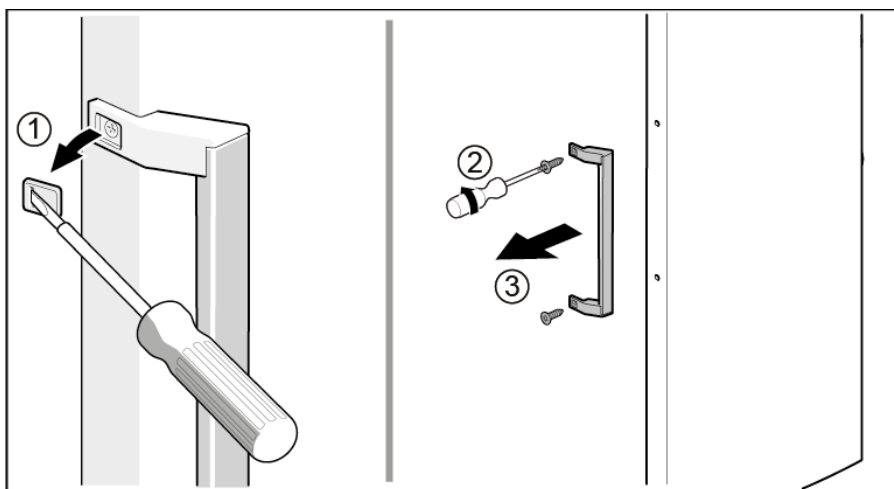

-  Durvju rokturis ir noņemts.

### 4.2.2 Durvju roktura uzstādīšana

- ▶ Uzstādiet apgrieztā kārtībā.

## 4.3 Easy opening handle (ērtās atvēršanas roktura) nomaiņa

Speciāli rīki:

- Phillips skrūvgriezis PH2

Prasība:

- ✓ Ierīces elektropadevei ir jābūt atvienotai.
- ✓ Durvīm ir jābūt atvērtām.

### 4.3.1 Easy opening handle (ērtās atvēršanas roktura) noņemšana

1. Noņemiet easy opening handle (ērtās atvēršanas roktura) pārsegu (1).
2. Izskrūvējiet abas skrūves (2).

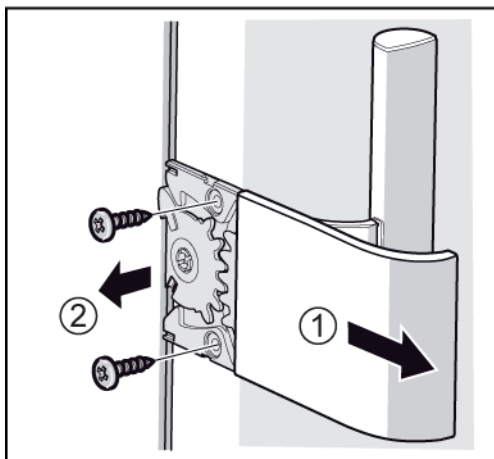

- ➔ Easy opening handle (ērtās atvēršanas rokturis) ir noņemts.

### 4.3.2 Easy opening handle (ērtās atvēršanas roktura) uzstādīšana

Pirms uzstāda easy opening handle (ērtās atvēršanas rokturi), tā mehānisms ir pareizi jāsaliek. Bīdstieņa (1), roboto kvadrantu (2) un (3), atsperes (4) un kustības ierobežotāja (5) pareizs salikums, lai uzstādītu kreisajā durvju pusē, ir parādīts attēlā.

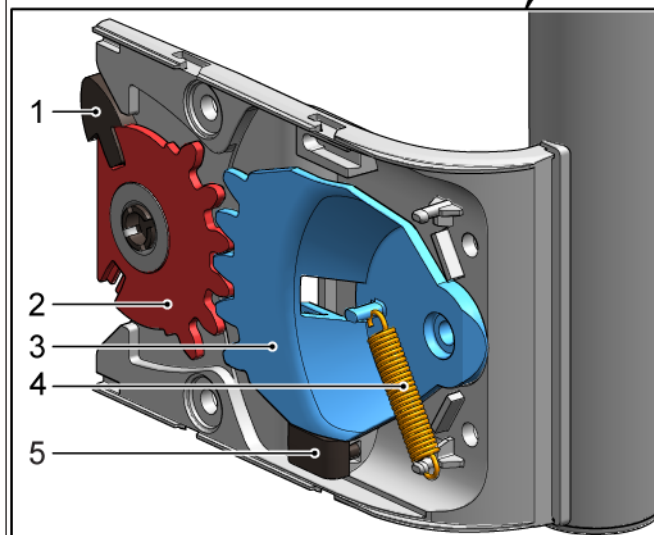
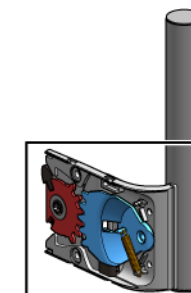

Easy opening handle (ērtās atvēršanas roktura) daļu salikums, lai uzstādītu labajā durvju pusē, ir aprakstīts dokumentā "Uzstādīšanas instrukcija".

- ▶ Uzstādiet apgrieztā kārtībā.

## 4.4 Durvju augšējās viras nomaiņa

Speciāli rīki:

 Torx uzgalis TX20

6,3 mm (1/4")

[00340865]

	<p><b>⚠ BRĪDINĀJUMS</b></p> <p><b>Smaga lielizmēra ierīce!</b> Muguras un muskuļu savainojumi</p> <ul style="list-style-type: none"><li>▶ Ierīces durvis drīkst noņemt tikai apmācīts speciālists.</li><li>▶ Ierīce ir jāpārvieta divatā.</li><li>▶ Ir jāizmanto tikai piemēroti darbarīki un aprīkojums.</li></ul>
	<p><b>⚠ ESIET PIESARDZĪGI</b></p> <p><b>Asas malas!</b> Grieztas brūces</p> <ul style="list-style-type: none"><li>▶ Lietojiet aizsargcimdus.</li></ul>
	<p><b>⚠ BRĪDINĀJUMS</b></p> <p><b>Sasvērušos ierīču paslīdēšana!</b> Kaulu lūzumi / saspiešanas traumas</p> <ul style="list-style-type: none"><li>▶ Nostipriniet ierīces, lai tās neslīdētu.</li></ul>
	<p><b>⚠ ESIET PIESARDZĪGI</b></p> <p><b>Krītošu detaļu risks, ko izraisa vaļīgās skrūves!</b> Krītošu detaļu izraisītas traumas.</p> <ul style="list-style-type: none"><li>▶ Nostipriniet detaļu, lai tā nenokristu.</li></ul>
	<p><b>UZMANĪBU!</b></p> <p><b>Krītošu detaļu risks, ko izraisa vaļīgās skrūves!</b> Citu ierīces detaļu bojājumi vai bojājumi, kas rodas klienta mājās, piem., apakšpuse.</p> <ul style="list-style-type: none"><li>▶ Nostipriniet detaļu, lai tā nenokristu.</li></ul>

Prasība:

- Ierīces elektropadevei ir jābūt atvienotai.
- Ierīces iekšējām daļām ir jābūt izņemtām.

## 4.4.1 Durvju viras noņemšana

1. Nolieciet ierīci uz aizmugures.

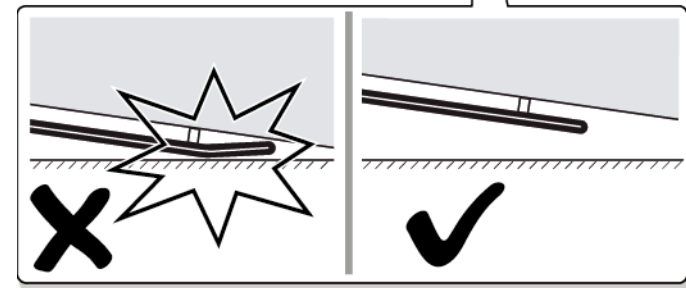
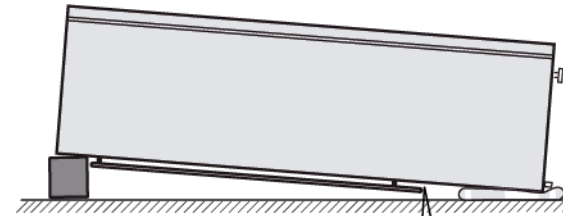
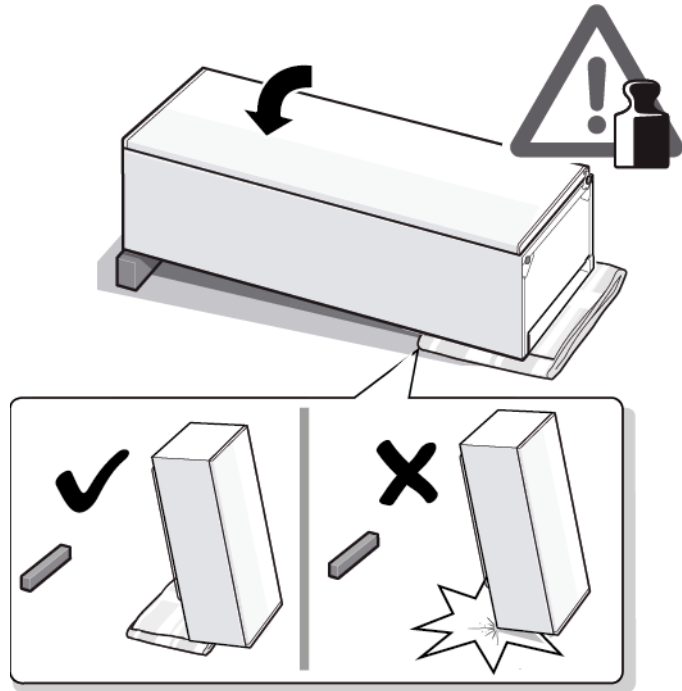

2. 1. Saspieties augšējās viras pārsega abus sānus (1).
2. Pavelciet augšējās viras pārsegu (2).
3. Noņemiet augšējās viras pārsegu (3).

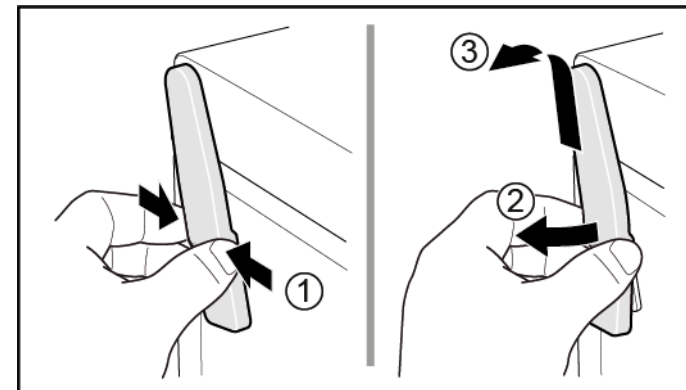

## Remonts

3. 1. Izskrūvējiet abas skrūves (1).
2. Noņemiet augšējo viru (2).

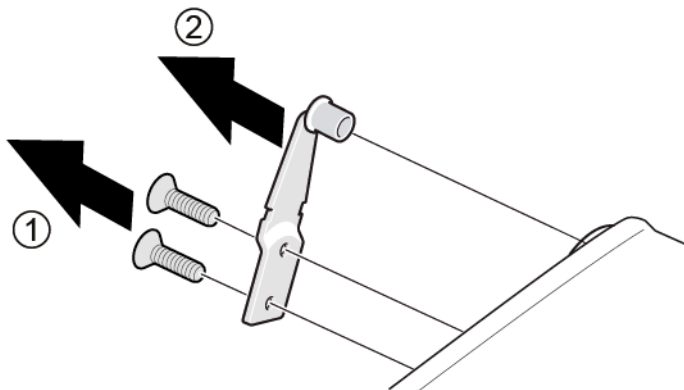

➔ Durvju augšējā vira ir noņemta.

### 4.4.2 Durvju viras uzstādīšana

- ▶ Uzstādiet apgrieztā kārtībā.

## 4.5 Durvju augšējās viras nomaiņa (durvis ar displeju)

Speciāli rīki:

 Torx uzgalis TX20      6,3 mm (1/4")      [00340865]

	<b>⚠ BRĪDINĀJUMS</b>
	<p><b>Smaga lielmēra ierīce!</b> Muguras un muskuļu savainojumi</p> <ul style="list-style-type: none"> <li>▶ Ierīces durvis drīkst noņemt tikai apmācīts speciālists.</li> <li>▶ Ierīce ir jāpārvieta divatā.</li> <li>▶ Ir jāizmanto tikai piemēroti darbarīki un aprīkojums.</li> </ul>

	<b>⚠ ESIET PIESARDZĪGI</b>
	<p><b>Asas malas!</b> Grieztas brūces</p> <ul style="list-style-type: none"> <li>▶ Lietojiet aizsargcimdus.</li> </ul>

	<b>⚠ BRĪDINĀJUMS</b>
	<p><b>Sasvērušos ierīču paslīdēšana!</b> Kaulu lūzumi / saspiešanas traumas</p> <ul style="list-style-type: none"> <li>▶ Nostipriniet ierīces, lai tās neslīdētu.</li> </ul>

	<b>⚠ ESIET PIESARDZĪGI</b>
	<p><b>Krītošu detaļu risks, ko izraisa vaļīgās skrūves!</b> Krītošu detaļu izraisītas traumas.</p> <ul style="list-style-type: none"> <li>▶ Nostipriniet detaļu, lai tā nenokristu.</li> </ul>

	<b>UZMANĪBU!</b>
	<p><b>Krītošu detaļu risks, ko izraisa vaļīgās skrūves!</b> Citu ierīces detaļu bojājumi vai bojājumi, kas rodas klienta mājās, piem., apakšpuse.</p> <ul style="list-style-type: none"> <li>▶ Nostipriniet detaļu, lai tā nenokristu.</li> </ul>

	<b>⚠ BĪSTAMI</b>
	<p><b>Elektrotrieciena risks spriegumaktīvu daļu dēļ!</b> Dzīvības apdraudējums nepareiza remonta izraisīta elektrotrieciena dēļ</p> <ul style="list-style-type: none"> <li>▶ Elektriskās daļas ir jāremontē kvalificētam elektriķim.</li> <li>▶ Pēc remonta ierīces drošība ir jāpārbauda atbilstīgi noteikumiem VDE 0701 vai valsts noteikumiem.</li> </ul>

	<b>⚠ BĪSTAMI</b>
	<p><b>Elektrotrieciena risks, ko rada spriegumaktīvas detaļas!</b> Nāvējošs elektrotrieciens</p> <ul style="list-style-type: none"> <li>▶ Atvienojiet iekārtas no strāvas padeves vismaz 60 sekundes pirms labošanas sākšanas.</li> </ul>

**Prasība:**

- Ierīces elektropadevei ir jābūt atvienotai.
- Ierīces iekšējām daļām ir jābūt izņemtām.

## 4.5.1 Durvju viras noņemšana

1. Nolieciet ierīci uz aizmugures.

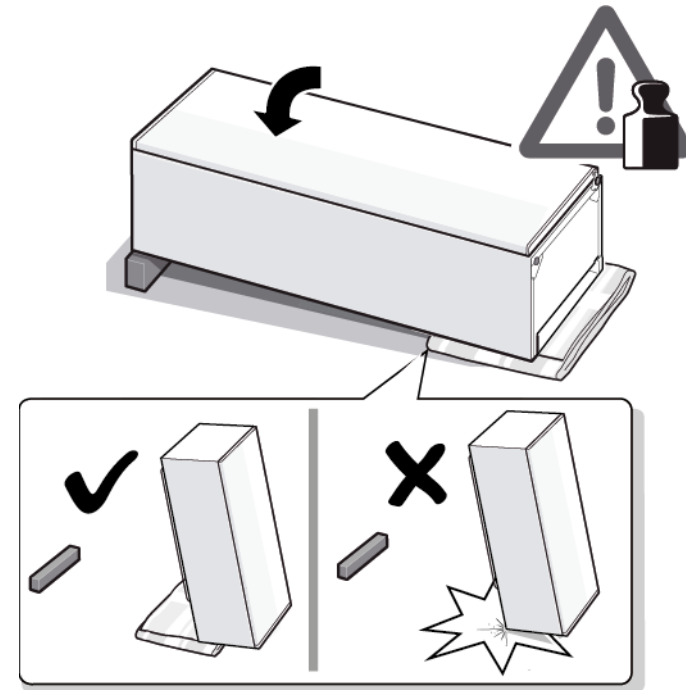

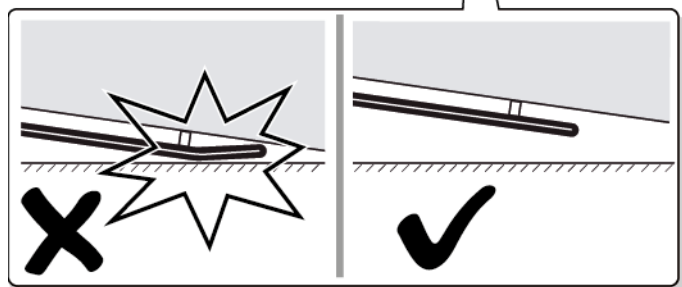
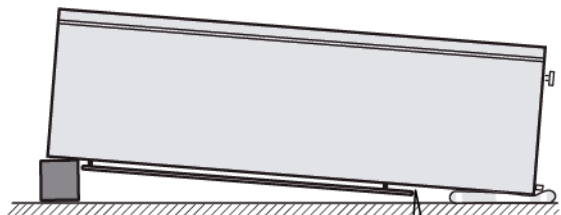

2. 1. Saspiediet augšējās viras pārsega abus sānus (1).
2. Pavelciet augšējās viras pārsegu (2).
3. Noņemiet augšējās viras pārsegu (3).

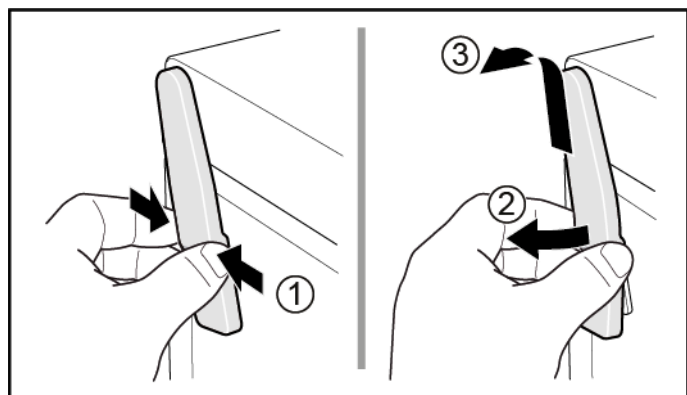

3. 1. Noņemiet kabeļa kārbas vāku (1).
2. Noņemiet kabeļa aizsargu (2).
3. Atvienojiet elektriskos savienojumus (3).
4. Izskrūvējiet abas skrūves (4).
5. Noņemiet augšējo viru (5).

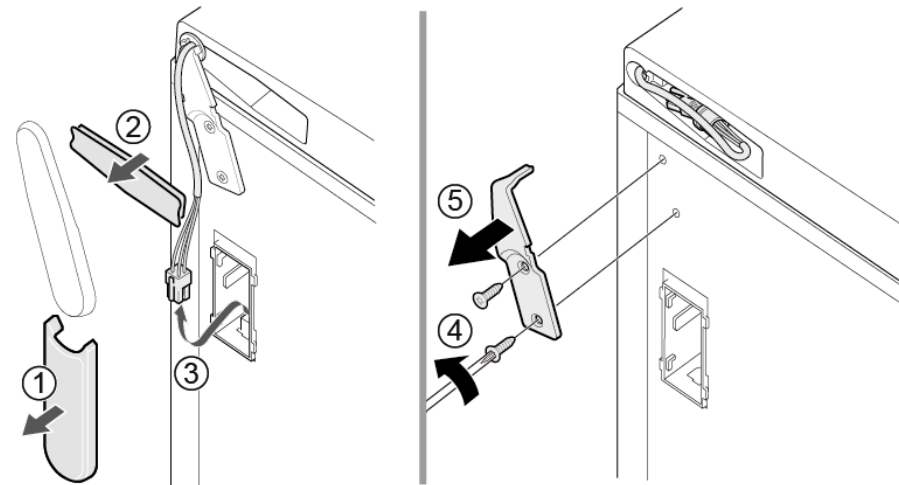

➔ Durvju augšējā vira ir noņemta.

## 4.5.2 Durvju viras uzstādīšana

- ▶ Uzstādiet apgrieztā kārtībā.



## 4.6 Durvju apakšējās viras nomaiņa

Speciāli rīki:

Torx uzgalis TX20 6,3 mm (1/4") [00340865]

	<b>BRĪDINĀJUMS</b>
	<p><b>Smaga lielizmēra ierīce!</b> Muguras un muskuļu savainojumi</p> <ul style="list-style-type: none"> <li>▶ Ierīces durvis drīkst noņemt tikai apmācīts speciālists.</li> <li>▶ Ierīce ir jāpārvieta divatā.</li> <li>▶ Ir jāizmanto tikai piemēroti darbarīki un aprīkojums.</li> </ul>

	<b>ESIET PIESARDZĪGI</b>
	<p><b>Asas malas!</b> Grieztas brūces</p> <ul style="list-style-type: none"> <li>▶ Lietojiet aizsargcimdus.</li> </ul>

	<b>BRĪDINĀJUMS</b>
	<p><b>Sasvērušos ierīču paslīdēšana!</b> Kaulu lūzumi / saspiešanas traumas</p> <ul style="list-style-type: none"> <li>▶ Nostipriniet ierīces, lai tās neslīdētu.</li> </ul>

	<b>ESIET PIESARDZĪGI</b>
	<p><b>Krītošu detaļu risks, ko izraisa vaļīgās skrūves!</b> Krītošu detaļu izraisītas traumas.</p> <ul style="list-style-type: none"> <li>▶ Nostipriniet detaļu, lai tā nenokristu.</li> </ul>

	<b>UZMANĪBU!</b>
	<p><b>Krītošu detaļu risks, ko izraisa vaļīgās skrūves!</b> Citu ierīces detaļu bojājumi vai bojājumi, kas rodas klienta mājās, piem., apakšpuse.</p> <ul style="list-style-type: none"> <li>▶ Nostipriniet detaļu, lai tā nenokristu.</li> </ul>

Prasība:

- ✔ Ierīces elektropadevei ir jābūt atvienotai.
- ✔ Ierīces iekšējām daļām ir jābūt izņemtām.
- ✔ Ierīcei ir jābūt noliktai uz aizmugures.
- ✔ [Augšējai virai ir jābūt noņemtai.→310](#)

### 4.6.1 Durvju apakšējās viras nomaiņa

1. Noņemiet durvis.

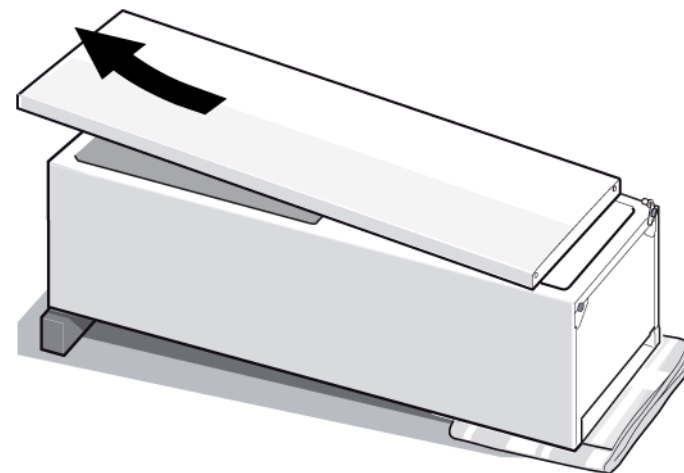

2. 1. Izskrūvējiet skrūvi (1).
2. Pagrieziet apakšējo viru uz āru (2).
3. Noņemiet apakšējo viru (3).

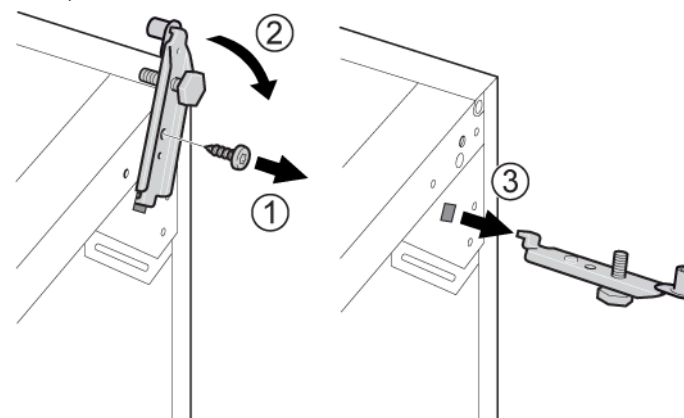

- ➡ Apakšējā vira ir noņemta.

### 4.6.2 Durvju apakšējās viras uzstādīšana

- ▶ Uzstādiet apgrieztā kārtībā.

## 4.7 Plaukta nomaiņa

### Prasība:

- ✔ Durvīm ir jābūt atvērtām.

### 4.7.1 Plaukta izņemšana

- ▶ Izvelciet plauktu.

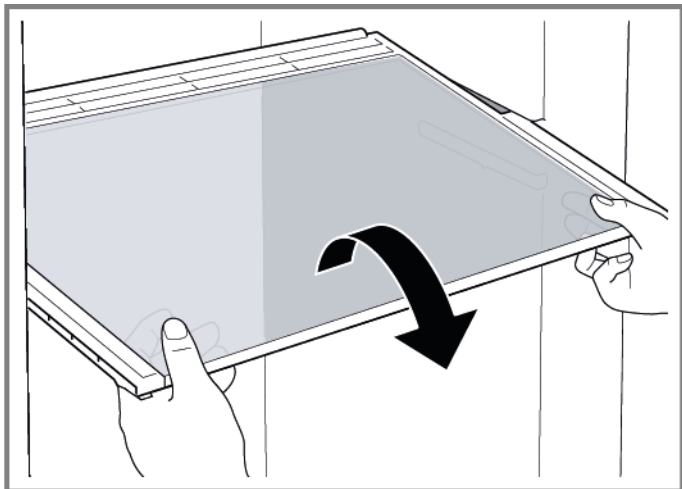

- ➡ Plaukts ir izņemts.

### 4.7.2 Plaukta uzstādīšana

- ▶ Uzstādiet apgrieztā kārtībā.

## 4.8 Saldētās pārtikas tvertnes nomaiņa

### Prasība:

- ✓ Durvīm ir jābūt atvērtām.

### 4.8.1 Saldētās pārtikas tvertnes izņemšana

- ▶ 1. Pilnībā izvelciet saldētās pārtikas tvertni (1).
- ▶ 2. Izņemiet saldētās pārtikas tvertni (2).

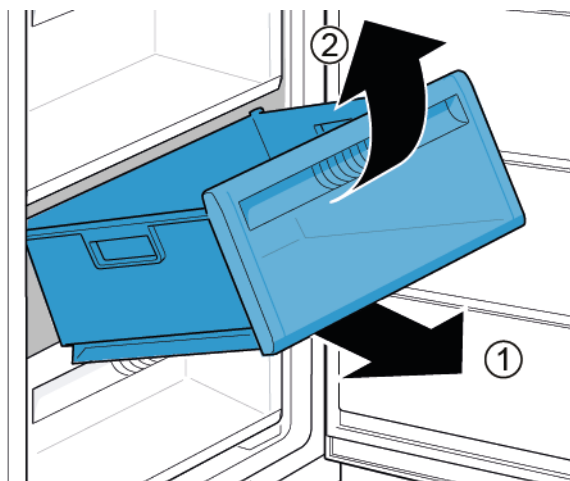

- ➡ Saldētās pārtikas tvertne ir izņemta.

### 4.8.2 Saldētās pārtikas tvertnes uzstādīšana

- ▶ Uzstādiet apgrieztā kārtībā.

## 4.9 Ledus tvertnes nomaiņa

### Prasība:

- ✓ Durvīm ir jābūt atvērtām.

### 4.9.1 Ledus tvertnes izņemšana

- ▶ 1. Izvelciet saldētās pārtikas plaukta tvertni kopā ar ledus tvertni (1).
- ▶ 2. Atbrīvojiet āķus (2).
- ▶ 3. Izņemiet ledus tvertni (3).

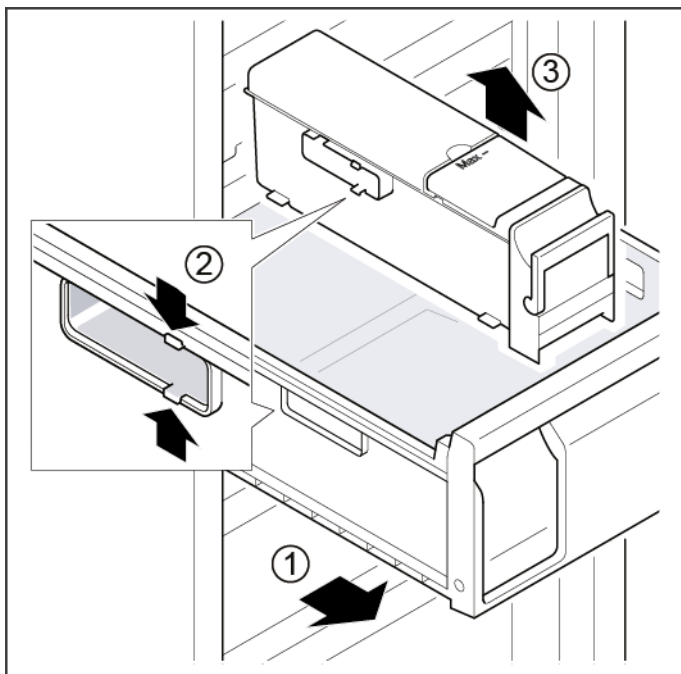

- ➡ Ledus tvertne ir izņemta.

### 4.9.2 Ledus tvertnes uzstādīšana

- ▶ Uzstādiet apgrieztā kārtībā.

## 4.10 Augšējā LED gaismekļa nomaiņa

### Speciāli rīki:

- Plakanais skrūvgriezis Izmērs: 2,4 mm x 0,4 mm x 60 mm, komplektā [00341820]

**i** Ierīcē ir LED gaismeklis, kam nav jāveic apkope. Šo gaismekli drīkst remontēt tikai klientu apkalpošanas dienesta pārstāvis vai pilnvarots tehniķis!

**⚠ BĪSTAMI**  
**Elektrotrieciena risks spriegumaktīvu daļu dēļ!**  
 Dzīvības apdraudējums nepareiza remonta izraisīta elektrotrieciena dēļ

- ▶ Elektriskās daļas ir jāremontē kvalificētam elektriķim.
- ▶ Pēc remonta ierīces drošība ir jāpārbauda atbilstīgi noteikumiem VDE 0701 vai valsts noteikumiem.

**⚠ BĪSTAMI**  
**Elektrotrieciena risks, ko rada spriegumaktīvas detaļas!**  
 Nāvējošs elektrotrieciens

- ▶ Atvienojiet iekārtas no strāvas padeves vismaz 60 sekundes pirms labošanas sākšanas.

**⚠ ESIET PIESARDZĪGI**  
**Asas malas!**  
 Griezta brūces

- ▶ Lietojiet aizsargcimdus.

### Prasība:

- ✓ Ierīces elektropadevei ir jābūt atvienotai.
- ✓ Durvīm ir jābūt atvērtām.
- ✓ Augšējām iekšējām daļām ir jābūt izņemtām.

### 4.10.1 LED gaismekļa noņemšana

1. Pārvietojiet LED gaismekli pa kreisi.

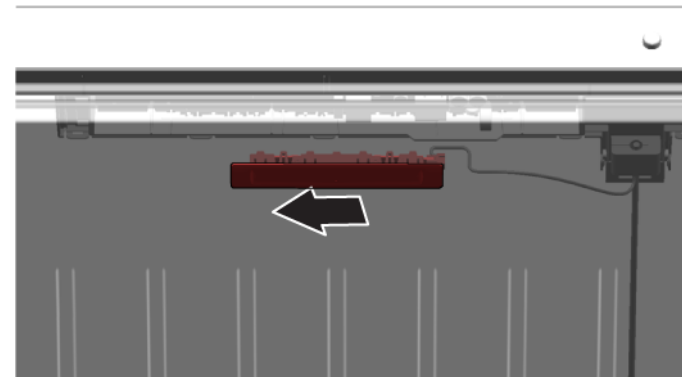

- ➡ LED gaismekļa elektriskais savienojums ir atvienots.

2. Atbrīvojiet LED gaismekļa āķus.

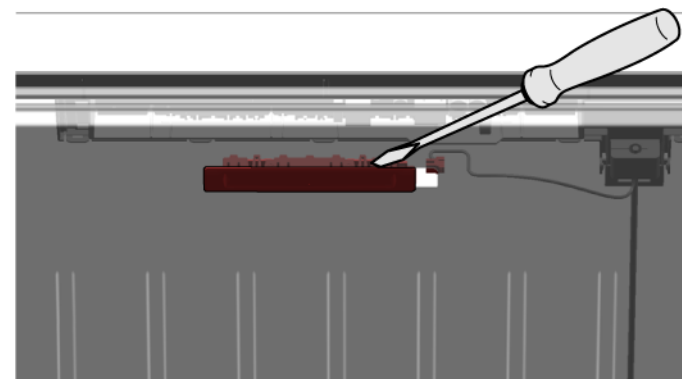

3. Lai noņemtu LED gaismekli, virziet to uz priekšu.

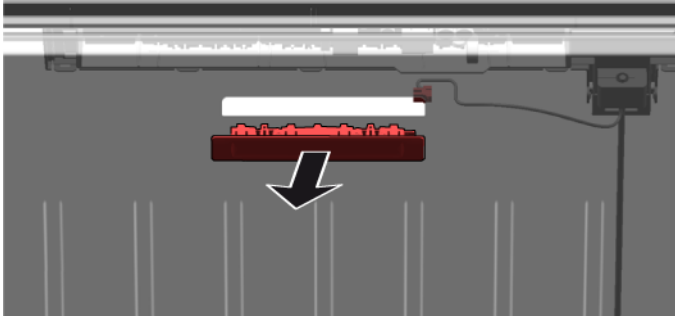





- ➔ LED gaismeklis ir noņemts.

### 4.10.2 Augšējā LED gaismekļa uzstādīšana

- ▶ Uzstādiet apgriezta kārtībā.

# Informacija apie remontą - Šaldiklis

 <b>Dėl šio dokumento</b> .....	<b>320</b>
1.1 Svarbi informacija .....	320
1.1.1 Paskirtis .....	320
1.2 Simbolių paaiškinimas .....	320
1.2.1 Pavojaus lygiai .....	320
1.2.2 Pavojaus simboliai .....	320
1.2.3 Įspėjimų struktūra .....	321
1.2.4 Bendrieji simboliai .....	321
 <b>Sauga</b> .....	<b>322</b>
2.1 Bendrosios saugos instrukcijos.....	322
2.1.1 Visi buitiniai prietaisai .....	322
 <b>Įrankiai ir pagalbinės priemonės</b> .....	<b>323</b>
 <b>Remontas</b> .....	<b>324</b>
4.1 Durelių tarpiklio keitimas .....	324
4.1.1 Durelių tarpiklio išėmimas.....	324
4.1.2 Durelių tarpiklio įdėjimas.....	324
4.2 Durelių rankenos keitimas .....	327
4.2.1 Durelių rankenos nuėmimas .....	327
4.2.2 Durelių rankenos tvirtinimas.....	327
4.3 „Easy open handle“ keitimas .....	328
4.3.1 „Easy open handle“ nuėmimas.....	328
4.3.2 „Easy open handle“ tvirtinimas .....	328
4.4 Durelių viršutinio vyro keitimas.....	329
4.4.1 Durelių vyro nuėmimas .....	329
4.4.2 Durelių vyro uždėjimas .....	331
4.5 Durelių viršutinio vyro keitimas (durelės su ekranu).....	332
4.5.1 Durelių vyro nuėmimas .....	333
4.5.2 Durelių vyro uždėjimas .....	334
4.6 Apatinio durelių vyro keitimas .....	335
4.6.1 Apatinio durelių vyro keitimas.....	335
4.6.2 Apatinio durelių vyro uždėjimas .....	335
4.7 Lentynos keitimas.....	336
4.7.1 Lentynos nuėmimas .....	336
4.7.2 Lentynos įdėjimas .....	336

4.8 Šaldytų maisto produktų talpyklos keitimas .....	337
4.8.1 Šaldytų maisto produktų talpyklos išėmimas .....	337
4.8.2 Šaldytų maisto produktų talpyklos įdėjimas .....	337
4.9 Ledo gaminimo įrenginio keitimas .....	338
4.9.1 Ledo gaminimo įrenginio išėmimas .....	338
4.9.2 Ledų gaminimo įrenginio įdėjimas.....	338
4.10 Viršutinės LED keitimas.....	339
4.10.1 LED lempučių išėmimas .....	339
4.10.2 Viršutinės LED lempučių montavimas.....	340

# **i** Dėl šio dokumento

## 1.1 Svarbi informacija

### 1.1.1 Paskirtis

Šios remonto nuorodos padeda naudotojui pataisyti prietaisus patiems pagal galiojantį ekologinio projektavimo reglamentą (2021 m. kovo mėn. redakcija).

Jose pateikta informacija, kaip pakeisti tam tikras atsargines dalis, įskaitant ir įspėjimus bei riziką.

Jei kiltų klausimų, kreipkitės į mūsų klientų aptarnavimo tarnybą. Mes atsakysime už žalą tik tuo atveju, jei bus tinkamai laikomasi remonto nuorodų.

## 1.2 Simbolių paaiškinimas

### 1.2.1 Pavojaus lygiai

Įspėjimo lygiai susideda iš simbolio ir signalinio žodžio. Signalinis žodis nurodo pavojaus sunkumą.





Įspėjimo lygis	Reikšmė
 <b>PAVOJUS</b>	Nepaisant įspėjamojo pranešimo, ištinka mirtis arba sunkūs sužalojimai.
 <b>ĮSPĖJIMAS</b>	Nepaisant įspėjamojo pranešimo, gali ištikti mirtis arba sunkūs sužalojimai.
 <b>PERSPĖJIMAS</b>	Nepaisant įspėjamojo pranešimo, galimi nedideli sužalojimai.
<b>DĖMESIO!</b>	Nepaisant įspėjamojo pranešimo, gali būti sugadintas turtas.

Lentelė 1: Pavojaus lygiai

### 1.2.2 Pavojaus simboliai



Pavojaus simboliai yra simboliniai atvaizdai, nurodantys pavojaus rūšį.

Šiame: dokumente naudojami tokie pavojaus simboliai

Pavojaus simbolis	Reikšmė
	Bendras įspėjamasis pranešimas
	Pavojinga elektros įtampa
	Sprogimo pavojus
	Įpjovimo pavojus
	Prispaudimo pavojus



## **i** Dėl šio dokumento

Pavojaus simbolis	Reikšmė
	Pavojus dėl karštų paviršių
	Pavojus dėl stipraus magnetinio lauko
	Pavojus dėl nejonizuojančiosios spinduliuotės

Lentelė 2: Pavojaus simboliai

### 1.2.3 Įspėjimų struktūra

Šiame dokumente pateikiami įspėjimai yra standartizuotos išvaizdos ir standartizuotos struktūros.



	<p><b>⚠ PAVOJUS</b></p> <p><b>Pavojaus tipas ir šaltinis!</b> Galimos pasekmės, jei nepaisoma pavojaus / įspėjimo.</p> <ul style="list-style-type: none"> <li>▶ Priemonės ir draudimai pavojui išvengti.</li> </ul>
--	---





Šiame pavyzdyje parodytas įspėjimas, įspėjantis apie elektros smūgį dėl dalių su įtampa. Paminėta priemonė, kaip išvengti pavojaus.

	<p><b>⚠ PAVOJUS</b></p> <p><b>Elektros smūgio pavojus dėl dalių, kuriose yra įtampa!</b> Mirtis dėl elektros smūgio</p> <ul style="list-style-type: none"> <li>▶ Prieš pradėdami remontą, ne mažiau kaip prieš 60 sekundžių atjunkite prietaisus nuo elektros tiekimo.</li> </ul>
--	---

### 1.2.4 Bendrieji simboliai

Šiame dokumente naudojami tokie bendrieji simboliai:

Bendr. simbolis	Reikšmė
	Žymi specialų patarimą (tekstas ir (arba) grafika)
	Žymi paprastą patarimą (tik tekstas)
	Žymi nuorodą į vaizdo pamoką

Bendr. simbolis	Reikšmė
	Žymi reikalingus įrankius
	Žymi reikalingas prielaidas
	Žymi sąlygą (jei ..., tai ...)
	Žymi rezultatą
[Paleisti]	Žymi klavišą arba ekrano mygtuką
[00123456]	Žymi dalies numerį
Būsena	Žymi rodomą tekstą / langą (prietaiso ekrane)

Lentelė 3: Bendrieji simboliai

## 2.1 Bendrosios saugos instrukcijos

### 2.1.1 Visi būtiniai prietaisai

#### **Elektros smūgio pavojus dėl dalių, kuriose yra įtampa!**

- Elektrinių konstrukcinių dalių remonto klaidos gali sukelti elektros smūgį!
- Prieš pradėdami dirbti, ne mažiau kaip prieš 60 sekundžių atjunkite prietaisą nuo maitinimo.
- Po remonto pasirūpinkite, kad būtų atliktas saugos bandymas pagal VDE 0701 arba šalyje galiojančius reglamentus.

#### **Pavojus susižeisti į aštrias briaunas!**

- Mūvėkite apsaugines pirštines.

#### **Prispaudimo rizika remonto, einamosios techninės priežiūros, sutrikimų šalinimo ir techninės priežiūros metu dėl sunkių ir judančių konstrukcinių dalių**

- Avėkite apsauginius batus.
- Apsaugokite sunkias konstrukcines dalis, kad jos nenukristų.
- Neartinkite kūno dalių prie judančių konstrukcinių dalių.



#### **Rizika prietaiso saugai / veikimui!**

- Naudokite tik originalias atsargines dalis.

#### **Elektrostatškai jautrių konstrukcinių dalių (ESD) pažeidimo rizika!**

- Nelieskite modulių, o taip pat ir jų jungčių bei laidininkų kelių.

## Įrankiai ir pagalbinės priemonės

Paskyrimas	Išsami informacija	Vaizdai
Apsauginis audinys [00342013]	60 cm x 50 cm	
„Phillips“ atsuktuvas PH2		
„Torx“ antgalis TX20 [00340865]	6,3 mm (1/4 col.)	
Atsuktuvas su įpjovomis	Mentė 2,4 mm x 0,4 mm x 60 mm, rinkinyje [00341820]	

## 4.1 Durelių tarpiklio keitimas

### Reikalavimas.

- ✔ Durelės turi būti atidarytos.

### 4.1.1 Durelių tarpiklio išėmimas

1. Išimkite durelių tarpiklį iš griovelio dešiniajame ir kairiajame kampe.

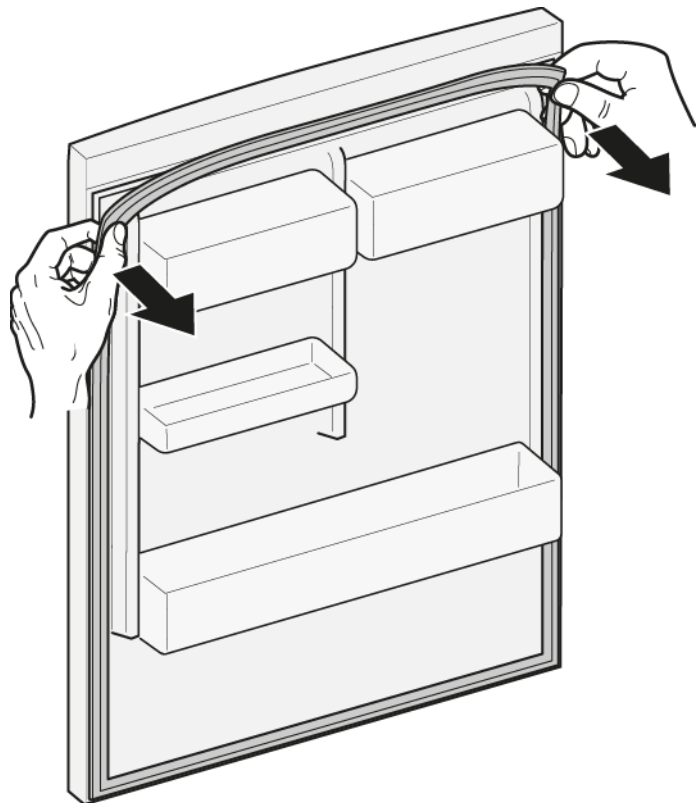

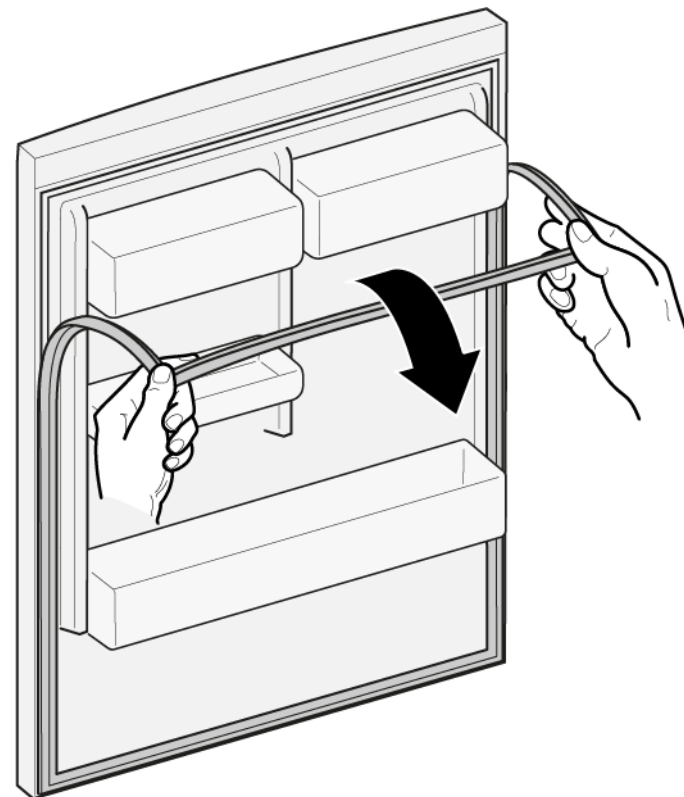

2. Ištraukite durelių tarpiklį iš griovelio.



- ➡ Durelių tarpiklis išimtas.

### 4.1.2 Durelių tarpiklio įdėjimas

	Naujo durelių tarpiklio storis gali šiek tiek skirtis nuo seno durelių tarpiklio storio. Dėl to durelės vis tiek užsidarys, o tarpiklį bus galima naudoti ilgai.
	Jei jūsų prietaiso vyriai arba vyrio priedai reguliuojami, uždarymo funkciją vėliau galima optimizuoti.
	Nedidelės šoninės skylutės durelių tarpiklyje turi savo funkciją (reikalingos ventiliacijai). Tai nėra gamybinis brokas.

1. Patikrinkite griovelį, ar nėra tarpiklių galinčių pažeisti vietų.

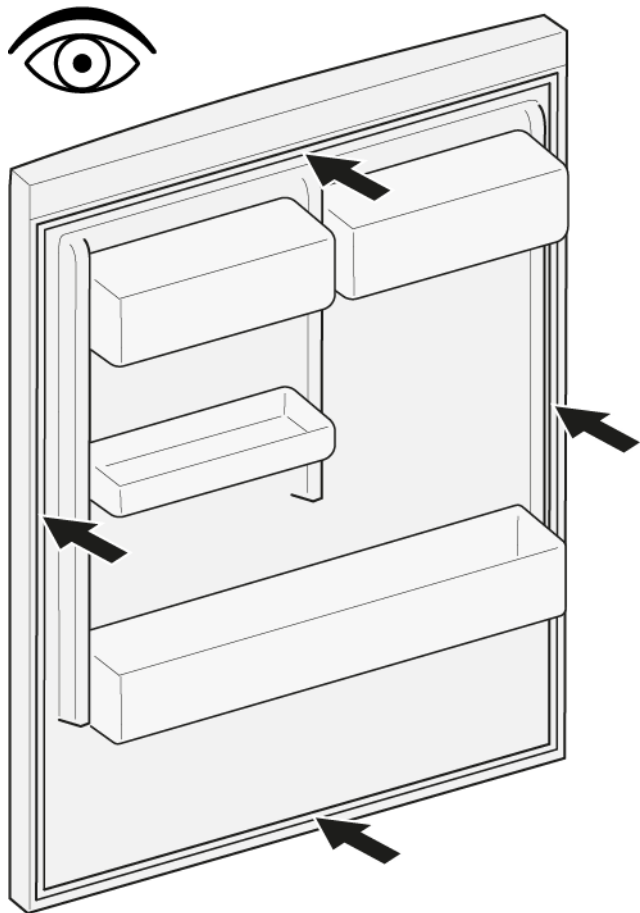

4. Įspauskite tarpiklio kampus viršuje ir apačioje į griovelį.

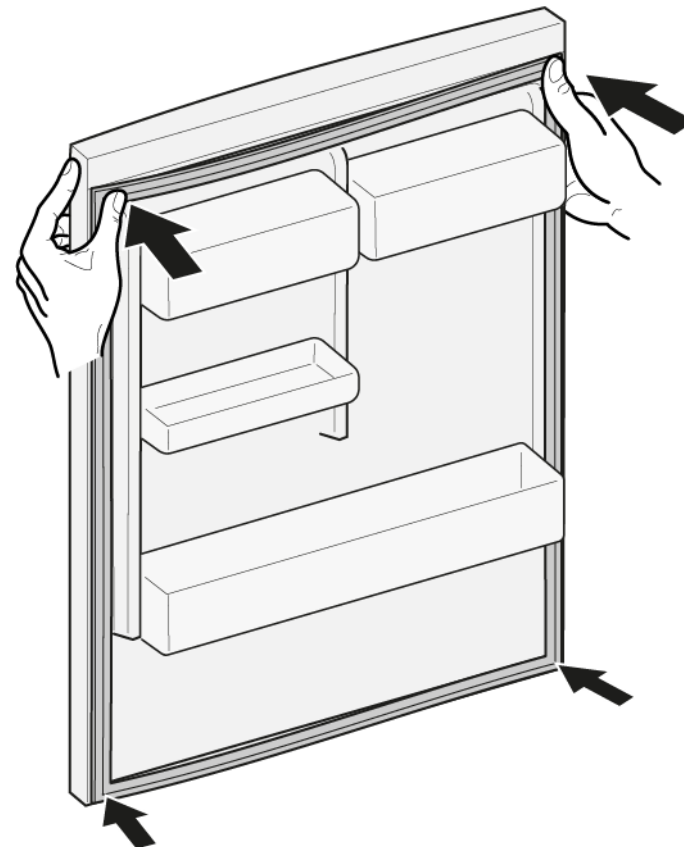

2.  Jei tarpiklio griovelis pažeistas.  
- Kreipkitės į klientų aptarnavimo tarnybą.

3.  Nedidelės durelių tarpiklio deformacijos yra įprastas požymis ir nepaveikia tarpiklio funkcinių savybių. Prieš įdedant durelių tarpiklį į prietaisą, rekomenduojama jį ištiesinti.

Pašildykite durelių tarpiklių plaukų džiovintuvu arba karštu vandeniu ir iš naujo suteikite formą rankiniu būdu.

5. Po truputį įspauskite į griovelį visą tarpiklį.

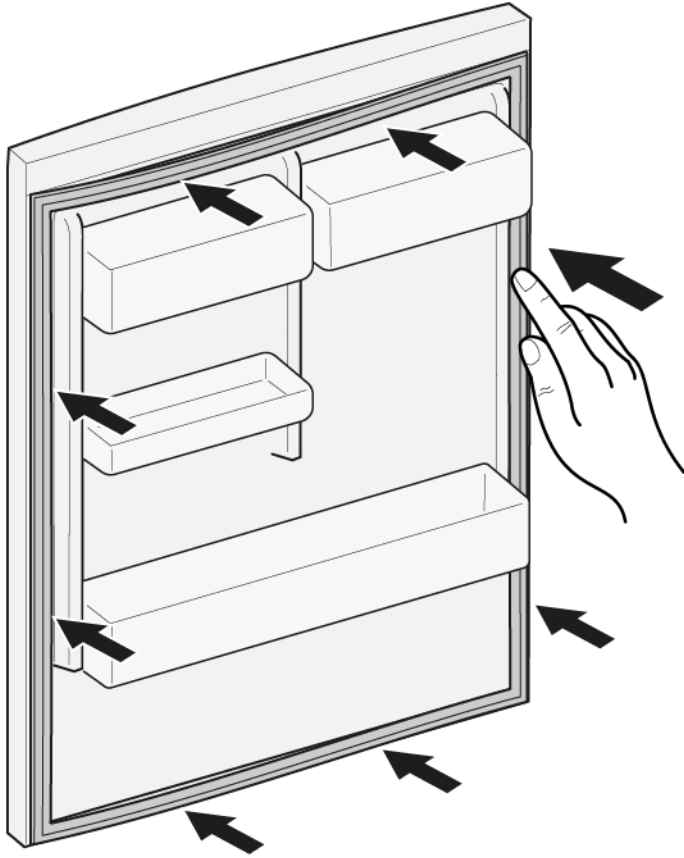

 Durelių tarpiklis įdėtas.

## 4.2 Durelių rankenos keitimas

### Specialūs įrankiai.

- „Torx“ antgalis TX20 6,3 mm (1/4 col.) [00340865]
- Atsuktuvus su įpjovomis Mentė 10 mm x 1,6 mm x 200 mm

### Reikalavimas.

- ✓ Prietaisas turi būti atjungtas nuo maitinimo šaltinio.
- ✓ Durelės turi būti atidarytos.

### 4.2.1 Durelių rankenos nuėmimas

- ▶ 1. Išimkite du varžtų gaubtelius (1).
- ▶ 2. Išsukite du varžtus (2).
- ▶ 3. Nuimkite durelių rankeną (3).

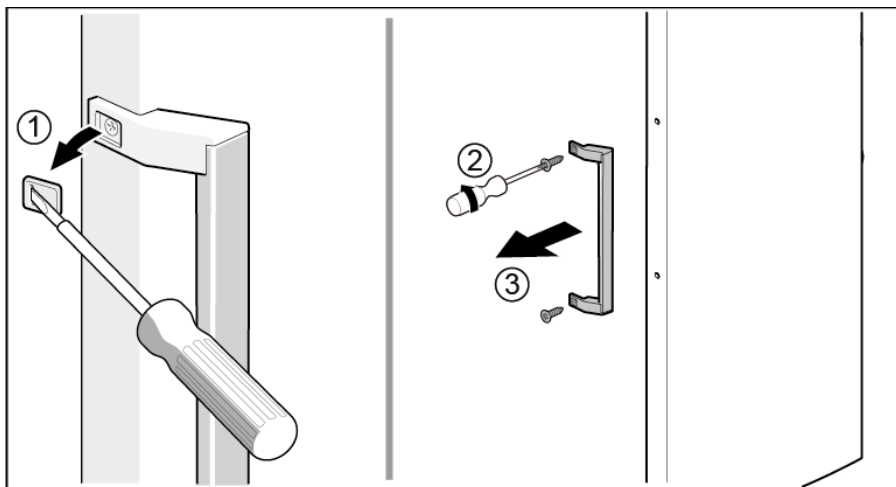

- ➔ Durelių rankena nuimta.

### 4.2.2 Durelių rankenos tvirtinimas

- ▶ Uždėkite atvirkščia eilės tvarka.

## 4.3 „Easy open handle“ keitimas

### Specialūs įrankiai.

- „Phillips“ atsuktuvus PH2

### Reikalavimas.

- ✓ Prietaisas turi būti atjungtas nuo maitinimo šaltinio.
- ✓ Durelės turi būti atidarytos.

### 4.3.1 „Easy open handle“ nuėmimas

- ▶ 1. Nuimkite „Easy open handle“ dangtelį (1).
- ▶ 2. Išsukite du varžtus (2).

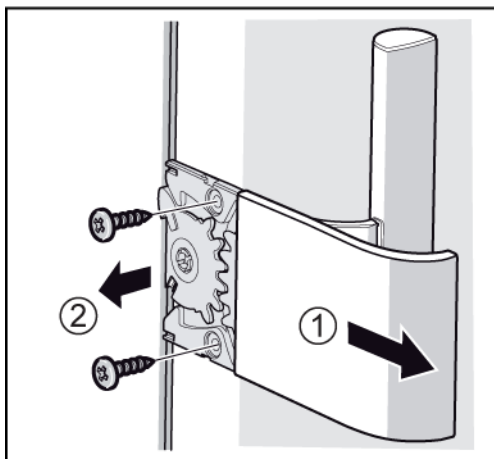

- ➔ „Easy open handle“ nuimta.

### 4.3.2 „Easy open handle“ tvirtinimas

„Easy open handle“ mechanizmą reikia tinkamai nustatyti prieš tvirtinant. Teisingas durelių stūmiklio (1), dantytų kvadrantų (2) ir (3), spyruoklės (4) ir ribotuvo stabdiklio (5) išdėstymas montuojant kairėje pusėje pavaizduotas paveikslėlyje.

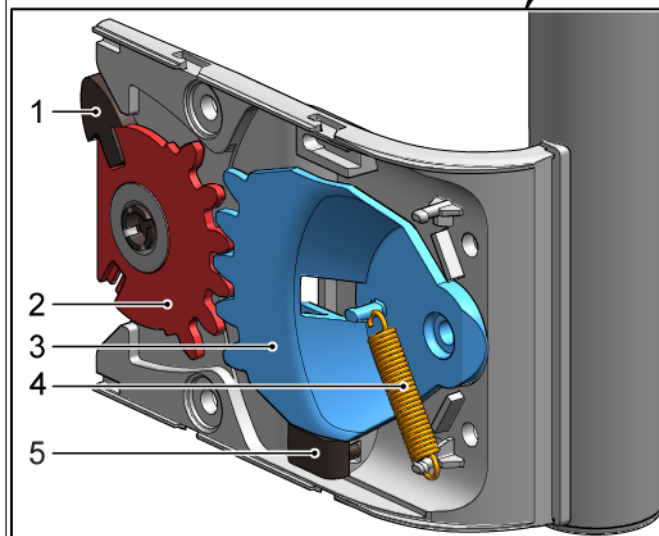

„Easy open handle“ komponentų išdėstymas montuojant dešinėje pusėje aprašytas dokumente „Įrengimo instrukcijos“.

- ▶ Uždėkite atvirkščia eilės tvarka.







## 4.4 Durelių viršutinio vyro keitimas

### Specialūs įrankiai.

 „Torx“ antgalis TX20

6,3 mm (1/4 col.)

[00340865]

	<p><b>⚠️ ĮSPĖJIMAS</b></p> <p><b>Sunkūs ir dideli prietaisai!</b> Nugaros ir raumenų sužalojimai</p> <ul style="list-style-type: none"><li>▶ Prietaiso dureles nuimti gali tik apmokyti specialistai.</li><li>▶ Norint perkelti prietaisą į kitą vietą, reikalingi du žmonės.</li><li>▶ Naudokite tik tinkamus įrankius ir įrangą.</li></ul>
	<p><b>⚠️ PERSPĖJIMAS</b></p> <p><b>Aštrios briaunos!</b> Galima įsipjauti</p> <ul style="list-style-type: none"><li>▶ Mūvėkite apsaugines pirštines.</li></ul>
	<p><b>⚠️ ĮSPĖJIMAS</b></p> <p><b>Paverstų prietaisų slydimas!</b> Galimi kaulų lūžiai ir prispaudimai</p> <ul style="list-style-type: none"><li>▶ Apsaugokite prietaisus, kad jie nepaslystų.</li></ul>
	<p><b>⚠️ PERSPĖJIMAS</b></p> <p><b>Pavojus, kad atpalaidavus varžtus dalys nukris!</b> Krentančios dalys gali sužeisti.</p> <ul style="list-style-type: none"><li>▶ Apsaugokite konstrukcinę dalį, kad ji nenukristų.</li></ul>
	<p><b>DĖMESIO!</b></p> <p><b>Pavojus, kad atpalaidavus varžtus dalys nukris!</b> Gali būti sugadintos kitos prietaiso dalys arba kliento namai, pvz., grindys.</p> <ul style="list-style-type: none"><li>▶ Apsaugokite konstrukcinę dalį, kad ji nenukristų.</li></ul>

### Reikalavimas.

- ✓ Prietaisas turi būti atjungtas nuo maitinimo šaltinio.
- ✓ Prietaiso vidiniai tvirtinimo elementai turi būti nuimti.

## 4.4.1 Durelių vyro nuėmimas

1. Paguldykite prietaisą ant galinės pusės.

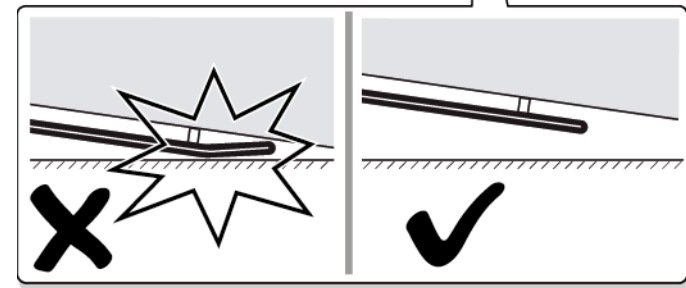
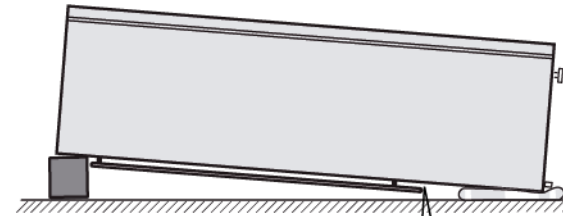
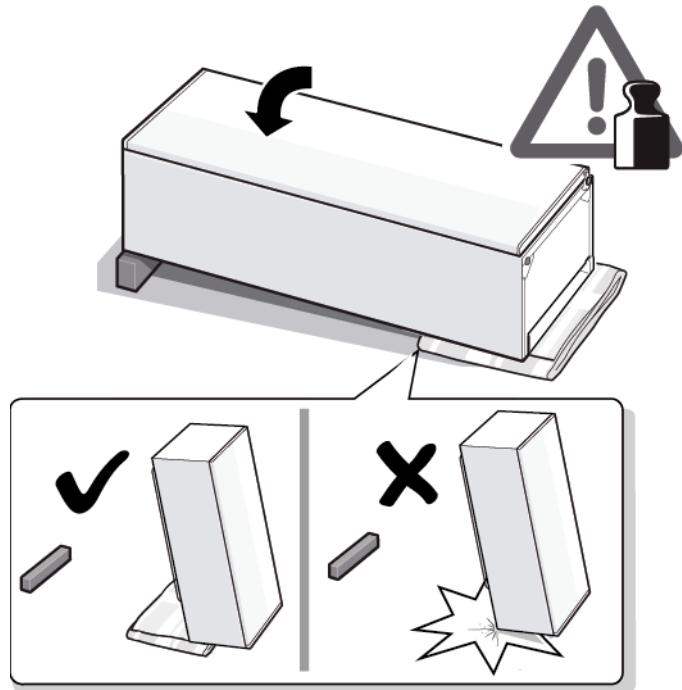

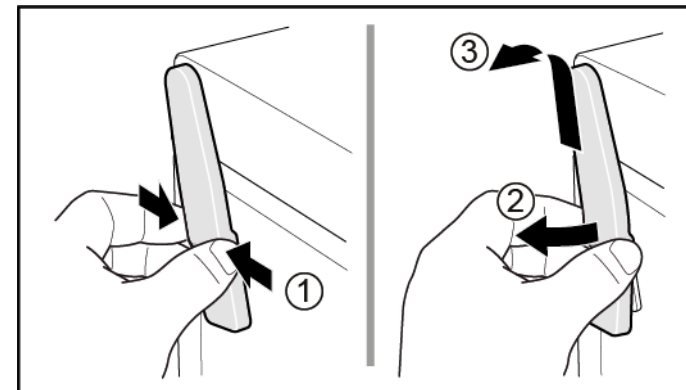

1. Spustelėkite viršutinio vyro dangtelį abiejose pusėse (1).
2. Atkelkite viršutinio vyro dangtelį (2).
3. Nuimkite viršutinio vyro dangtelį (3).

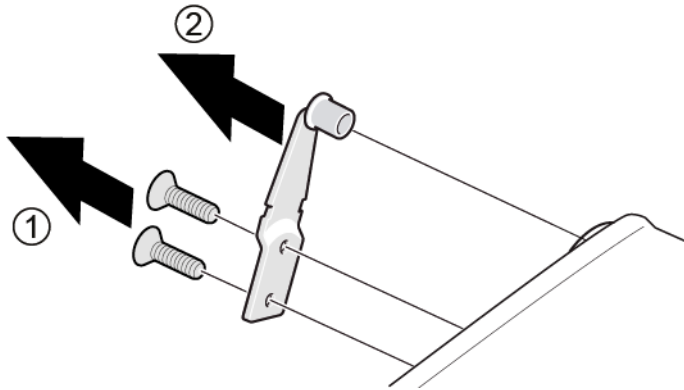

## Remontas

3. 1. Išsukite du varžtus (1).
2. Nuimkite viršutinį vyrį (2).



 Durelių viršutinis vyris nuimtas.

### 4.4.2 Durelių vyro uždėjimas

- ▶ Uždėkite atvirkščia eilės tvarka.

## 4.5 Durelių viršutinio vyro keitimas (durelės su ekranu)

Specialūs įrankiai.

„Torx“ antgalis TX20

6,3 mm (1/4 col.)

[00340865]

	<p style="text-align: center;"><b>⚠️ ĮSPĖJIMAS</b></p> <p><b>Sunkūs ir dideli prietaisai!</b> Nugaros ir raumenų sužalojimai</p> <ul style="list-style-type: none"> <li>▶ Prietaiso dureles nuimti gali tik apmokyti specialistai.</li> <li>▶ Norint perkelti prietaisą į kitą vietą, reikalingi du žmonės.</li> <li>▶ Naudokite tik tinkamus įrankius ir įrangą.</li> </ul>
	<p style="text-align: center;"><b>⚠️ PERSPĖJIMAS</b></p> <p><b>Aštrios briaunos!</b> Galima įsijauti</p> <ul style="list-style-type: none"> <li>▶ Mūvėkite apsaugines pirštines.</li> </ul>
	<p style="text-align: center;"><b>⚠️ ĮSPĖJIMAS</b></p> <p><b>Paverstų prietaisų slydimas!</b> Galimi kaulų lūžiai ir prispaudimai</p> <ul style="list-style-type: none"> <li>▶ Apsaugokite prietaisus, kad jie nepaslystų.</li> </ul>
	<p style="text-align: center;"><b>⚠️ PERSPĖJIMAS</b></p> <p><b>Pavojus, kad atpalaidavus varžtus dalys nukris!</b> Krentančios dalys gali sužeisti.</p> <ul style="list-style-type: none"> <li>▶ Apsaugokite konstrukcinę dalį, kad ji nenukristų.</li> </ul>
	<p style="text-align: center;"><b>DĖMESIO!</b></p> <p><b>Pavojus, kad atpalaidavus varžtus dalys nukris!</b> Gali būti sugadintos kitos prietaiso dalys arba kliento namai, pvz., grindys.</p> <ul style="list-style-type: none"> <li>▶ Apsaugokite konstrukcinę dalį, kad ji nenukristų.</li> </ul>

	<p style="text-align: center;"><b>⚠️ PAVOJUS</b></p> <p><b>Elektros smūgio pavojus dėl dalių, kuriose yra įtampa!</b> Pavojus gyvybei dėl elektros smūgio netinkamo remonto atveju</p> <ul style="list-style-type: none"> <li>▶ Elektrines dalis remontuoti turi kvalifikuoti elektrikai.</li> <li>▶ Po remonto pasirūpinkite, kad būtų atliktas saugos bandymas pagal VDE 0701 arba šalyje galiojančius reglamentus.</li> </ul>
---	--

	<p style="text-align: center;"><b>⚠️ PAVOJUS</b></p> <p><b>Elektros smūgio pavojus dėl dalių, kuriose yra įtampa!</b> Mirtis dėl elektros smūgio</p> <ul style="list-style-type: none"> <li>▶ Prieš pradėdami remontą, ne mažiau kaip prieš 60 sekundžių atjunkite prietaisus nuo elektros tiekimo.</li> </ul>
---	--

**Reikalavimas.**

- ✓ Prietaisas turi būti atjungtas nuo maitinimo šaltinio.
- ✓ Prietaiso vidiniai tvirtinimo elementai turi būti nuimti.

## 4.5.1 Durelių vyro nuėmimas

1. Paguldykite prietaisą ant galinės pusės.

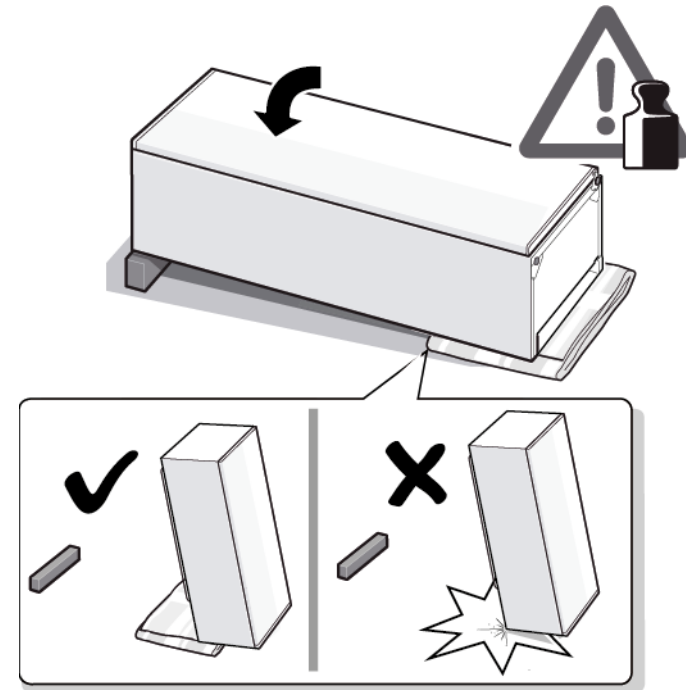

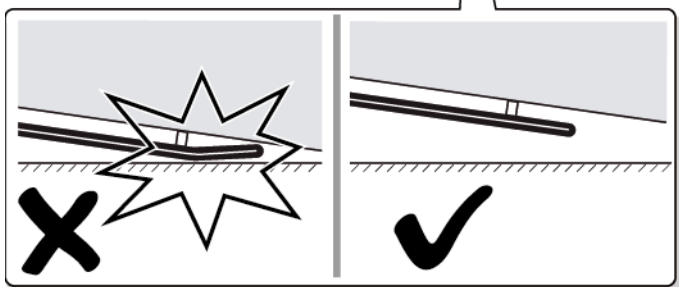
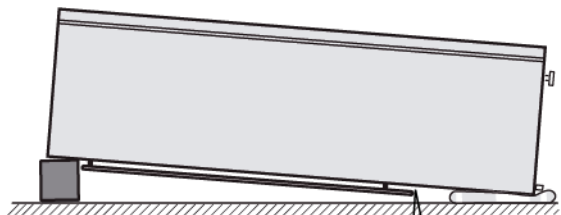

1. Spustelėkite viršutinio vryio dangtelį abiejose pusėse (1).
2. Atkelkite viršutinio vryio dangtelį (2).
3. Nuimkite viršutinio vryio dangtelį (3).

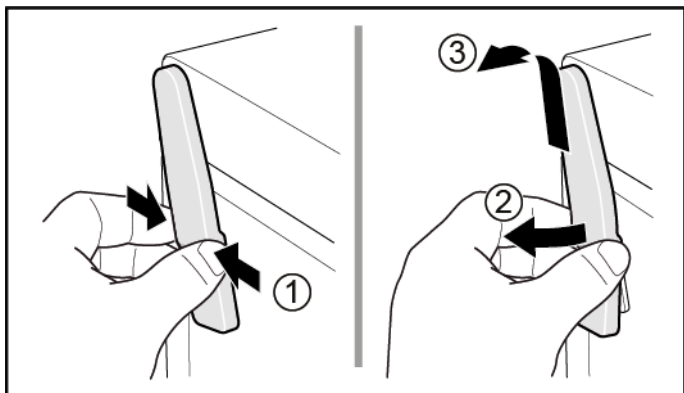

3. 1. Nuimkite kabelių dėžutės dangtelį (1).
2. Nuimkite kabelio apsaugą (2).
3. Atjunkite elektros jungtį (3).
4. Išsukite du varžtus (4).
5. Nuimkite viršutinį vryį (5).

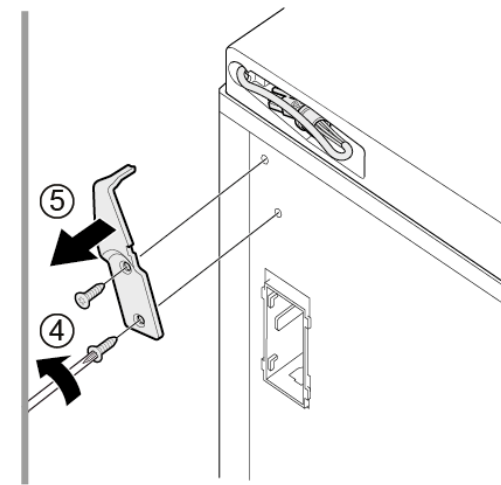
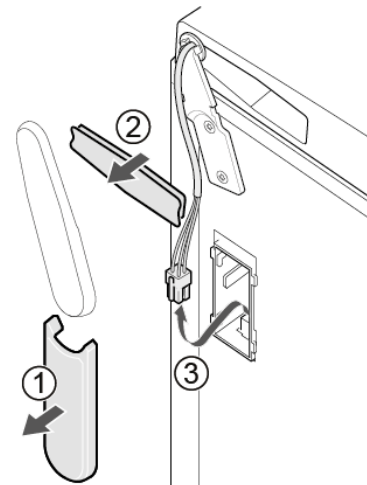

➔ Durelių viršutinis vryis nuimtas.

## 4.5.2 Durelių vryio uždėjimas

- ▶ Uždėkite atvirkščia eilės tvarka.





## 4.6 Apatinio durelių vyro keitimas

### Specialūs įrankiai.

„Torx“ antgalis TX20

6,3 mm (1/4 col.)

[00340865]

	<p style="text-align: center;"><b>⚠️ ĮSPĖJIMAS</b></p> <p><b>Sunkūs ir dideli prietaisai!</b> Nugaros ir raumenų sužalojimai</p> <ul style="list-style-type: none"> <li>▶ Prietaiso dureles nuimti gali tik apmokyti specialistai.</li> <li>▶ Norint perkelti prietaisą į kitą vietą, reikalingi du žmonės.</li> <li>▶ Naudokite tik tinkamus įrankius ir įrangą.</li> </ul>
	<p style="text-align: center;"><b>⚠️ PERSPĖJIMAS</b></p> <p><b>Aštrios briaunos!</b> Galima įsipjauti</p> <ul style="list-style-type: none"> <li>▶ Mūvėkite apsaugines pirštines.</li> </ul>
	<p style="text-align: center;"><b>⚠️ ĮSPĖJIMAS</b></p> <p><b>Paverstų prietaisų slydimas!</b> Galimi kaulų lūžiai ir prispaudimai</p> <ul style="list-style-type: none"> <li>▶ Apsaugokite prietaisus, kad jie nepaslystų.</li> </ul>
	<p style="text-align: center;"><b>⚠️ PERSPĖJIMAS</b></p> <p><b>Pavojus, kad atpalaidavus varžtus dalys nukris!</b> Krentančios dalys gali sužeisti.</p> <ul style="list-style-type: none"> <li>▶ Apsaugokite konstrukcinę dalį, kad ji nenukristų.</li> </ul>
	<p style="text-align: center;"><b>⚠️ DĖMESIO!</b></p> <p><b>Pavojus, kad atpalaidavus varžtus dalys nukris!</b> Gali būti sugadintos kitos prietaiso dalys arba kliento namai, pvz., grindys.</p> <ul style="list-style-type: none"> <li>▶ Apsaugokite konstrukcinę dalį, kad ji nenukristų.</li> </ul>

### Reikalavimas.

- ✔️ Prietaisas turi būti atjungtas nuo maitinimo šaltinio.
- ✔️ Prietaiso vidiniai tvirtinimo elementai turi būti nuimti.
- ✔️ Prietaisas turi būti paguldytas ant galinės pusės.
- ✔️ [Viršutinis vyris turi būti nuimtas. → 332](#)

### 4.6.1 Apatinio durelių vyro keitimas

1. Nuimkite dureles.

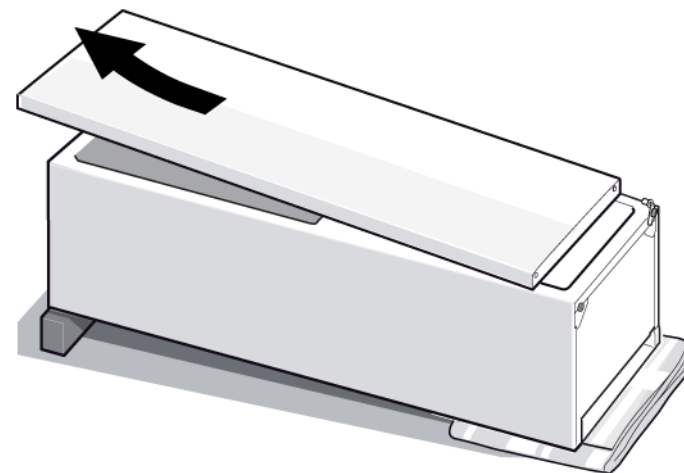

2. 1. Išsukite varžtą (1).
2. Pasukite apatinį vyrį į išorę (2).
3. Nuimkite apatinį vyrį (3).

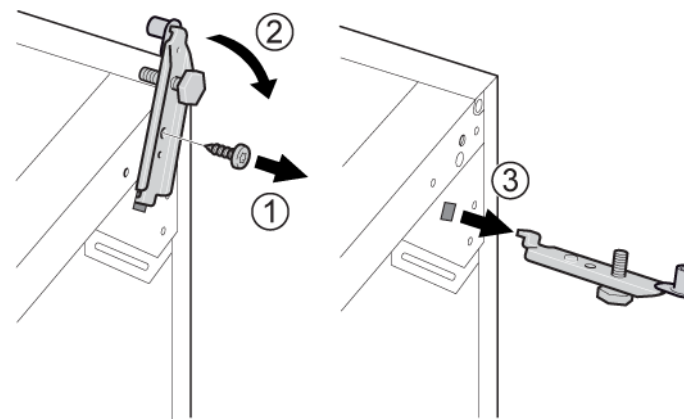

- ➡️ Apatinis vyris nuimtas.

### 4.6.2 Apatinio durelių vyro uždėjimas

- ▶ Uždėkite atvirkščia eilės tvarka.

## 4.7 Lentynos keitimas

### Reikalavimas.

- ✔ Durelės turi būti atidarytos.

### 4.7.1 Lentynos nuėmimas

- ▶ Ištraukite lentyną.

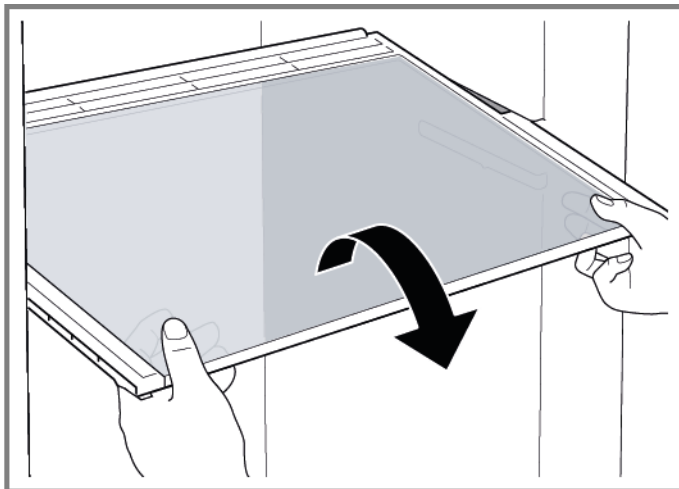

- ➡ Lentyna išimta.

### 4.7.2 Lentynos įdėjimas

- ▶ Uždėkite atvirkščia eilės tvarka.



## 4.8 Šaldytų maisto produktų talpyklos keitimas

### Reikalavimas.

- ✔ Durelės turi būti atidarytos.

### 4.8.1 Šaldytų maisto produktų talpyklos išėmimas

- ▶ 1. Ištraukite šaldytų maisto produktų talpyklą iki pat galo (1).
- ▶ 2. Išimkite šaldytų maisto produktų talpyklą (2).

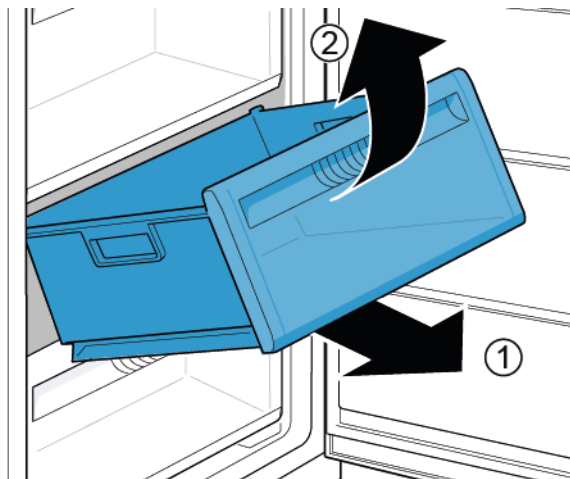

- ➡ Šaldytų maisto produktų talpykla išimta.

### 4.8.2 Šaldytų maisto produktų talpyklos įdėjimas

- ▶ Uždėkite atvirkščia eilės tvarka.

## 4.9 Ledo gaminimo įrenginio keitimas

### Reikalavimas.

- ✔ Durelės turi būti atidarytos.

### 4.9.1 Ledo gaminimo įrenginio išėmimas

- ▶ 1. Ištraukite šaldytų maisto produktų talpyklos lentyną su ledo gaminimo įrenginiu iki pat galo (1).
- ▶ 2. Atleiskite kabliukus (2).
- ▶ 3. Išimkite ledo gaminimo įrenginį (3).

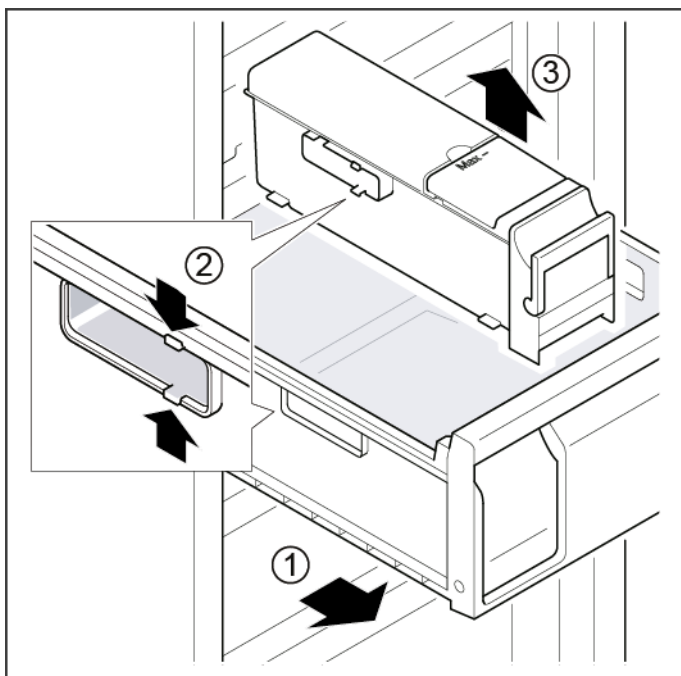

➡ Ledų gaminimo įrenginys išimtas.

### 4.9.2 Ledų gaminimo įrenginio įdėjimas

- ▶ Uždėkite atvirkščia eilės tvarka.

## 4.10 Viršutinės LED keitimas

### Specialūs įrankiai.

- Atsuktuvas su įpjovomis
- Mentė 2,4 mm x 0,4 mm x 60 mm, rinkinyje [00341820]



Jūsų prietaise įrengta techninės priežiūros nereikalaujanti LED lemputė. Šią lemputę gali taisyti tik klientų aptarnavimo tarnybos specialistai arba įgalioti technikai!



### ⚠ PAVOJUS

#### Elektros smūgio pavojus dėl dalių, kuriose yra įtampa!

Pavojus gyvybei dėl elektros smūgio netinkamo remonto atveju

- ▶ Elektrinės dalis remontuoti turi kvalifikuoti elektrikai.
- ▶ Po remonto pasirūpinkite, kad būtų atliktas saugos bandymas pagal VDE 0701 arba šalyje galiojančius reglamentus.



### ⚠ PAVOJUS

#### Elektros smūgio pavojus dėl dalių, kuriose yra įtampa!

Mirtis dėl elektros smūgio

- ▶ Prieš pradėdami remontą, ne mažiau kaip prieš 60 sekundžių atjunkite prietaisus nuo elektros tiekimo.



### ⚠ PERSPĖJIMAS

#### Aštrios briaunos!

Galima įsipjauti

- ▶ Mūvėkite apsaugines pirštines.

### Reikalavimas.

- ✔ Prietaisas turi būti atjungtas nuo maitinimo šaltinio.
- ✔ Durelės turi būti atidarytos.
- ✔ Viršutiniai vidiniai tvirtinimo elementai turi būti nuimti.

## 4.10.1 LED lemputės išėmimas

1. Perkelkite LED lemputę į kairę.

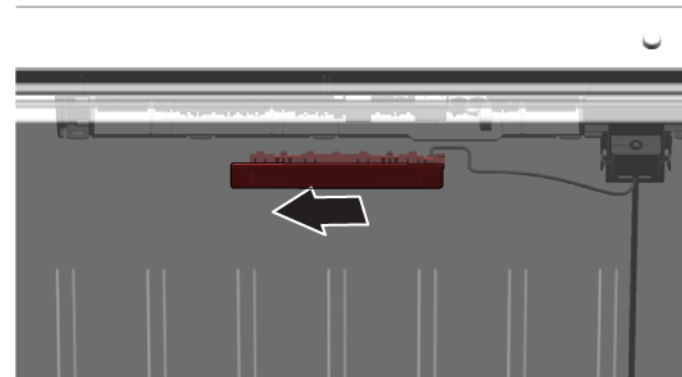

- ➡ LED elektros jungtis turi būti atjungta.

2. Atleiskite LED lemputės kabliukus.

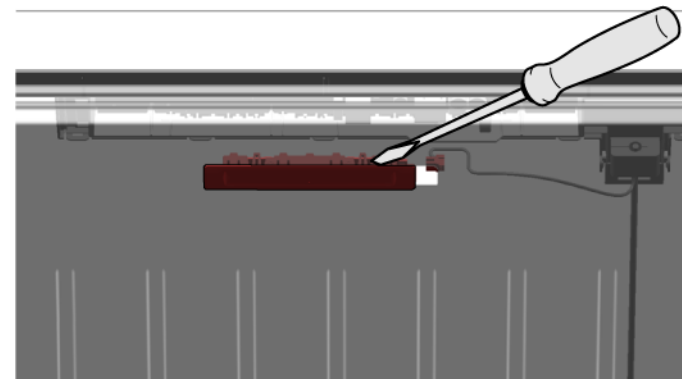

3. Išimkite LED lempuotę, perkeldami ją į priekį.

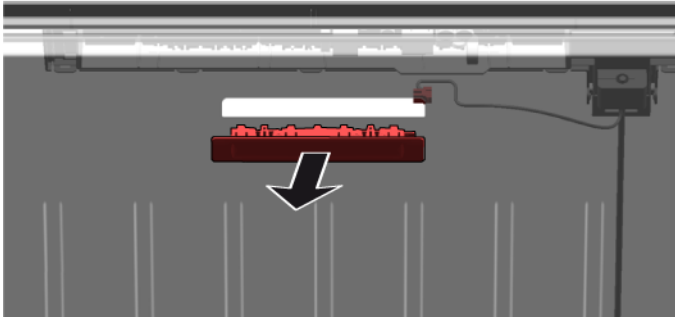

- ➔ LED lempuotė išimta.

### 4.10.2 Viršutinės LED lempuotės montavimas

- ▶ Uždėkite atvirkščią eilės tvarka.

# Reparasjonstips - Fryser

 <b>Om dette dokumentet</b> .....	<b>342</b>
1.1 Viktig informasjon .....	342
1.1.1 Formål.....	342
1.2 Forklaring av symboler.....	342
1.2.1 Farenivåer .....	342
1.2.2 Faresymboler.....	342
1.2.3 Advarslenes struktur .....	343
1.2.4 Generelle symboler .....	343
 <b>Sikkerhet</b> .....	<b>344</b>
2.1 Generelle sikkerhetsinstruksjoner .....	344
2.1.1 Alle husholdningsapparater .....	344
 <b>Verktøy og hjelpemidler</b> .....	<b>345</b>
 <b>Reparasjon</b> .....	<b>346</b>
4.1 Utskiftning av dørpakning.....	346
4.1.1 Demontering av dørpakning.....	346
4.1.2 Montering av dørpakning .....	346
4.2 Utskiftning av dørhåndtak.....	349
4.2.1 Demontering av dørhåndtak .....	349
4.2.2 Montering av dørhåndtak.....	349
4.3 Utskiftning av easy opening handle.....	350
4.3.1 Demontering av easy opening handle.....	350
4.3.2 Montering av easy opening handle .....	350
4.4 Utskiftning av øvre dørhengsel .....	351
4.4.1 Demontering av dørhengsel.....	351
4.4.2 Montering av dørhengsel .....	353
4.5 Utskiftning av øvre dørhengsel (dør med display) .....	354
4.5.1 Demontering av dørhengsel.....	355
4.5.2 Montering av dørhengsel .....	356
4.6 Utskiftning av nedre dørhengsel .....	357
4.6.1 Utskiftning av nedre dørhengsel.....	357
4.6.2 Montering av nedre dørhengsel .....	357
4.7 Utskiftning av hylle.....	358
4.7.1 Demontering av hylle.....	358
4.7.2 Montering av hylle .....	358

4.8 Utskiftning av beholder for frysevarer .....	359
4.8.1 Demontering av beholder for frysevarer .....	359
4.8.2 Montering av beholder for frysevarer .....	359
4.9 Utskiftning av ismaskin .....	360
4.9.1 Demontering av ismaskin .....	360
4.9.2 Montering av ismaskin .....	360
4.10 Utskiftning av øverste LED-lampe .....	361
4.10.1 Demontering av LED-lampe .....	361
4.10.2 Montering av øverste LED-lampe .....	362

# i Om dette dokumentet

## 1.1 Viktig informasjon

### 1.1.1 Formål

Disse tipsene om reparasjon skal hjelpe kunden til selv å kunne reparere apparater i samsvar med gjeldende regulering av øko-design (med gyldighet 03/2021).



De inneholder informasjon om hvordan definerte reservedeler skiftes, inklusive advarsler og risikoer.

Kontakt vår kundeservice dersom du har spørsmål. Vi påtar oss kun ansvar for skader dersom tipsene om reparasjon er korrekt fulgt.

## 1.2 Forklaring av symboler

### 1.2.1 Farenivåer

Advarslene som viser farenivå, består av et symbol og et signalord. Signalordet viser hvor alvorlig faren er.





Advarsel som viser farenivå	Betydning
 <b>FARE</b>	Dersom advarselen ignoreres, vil det føre til død eller alvorlige personskader.
 <b>ADVARSEL</b>	Dersom advarselen ignoreres, kan det føre til død eller alvorlige personskader.
 <b>FORSIKTIG</b>	Dersom advarselen ignoreres, kan det føre til mindre personskader.
 <b>OBS!</b>	Dersom advarselen ignoreres, kan det føre til materiell skade.

Tabell 1: Farenivåer



### 1.2.2 Faresymboler

Faresymboler er symbolske fremstillinger som gir en indikasjon av hvilken type fare det dreier seg om.

Følgende faresymboler brukes i dette dokumentet:

Faresymbol	Betydning
	Generell advarsel
	Fare for elektrisk støt
	Eksplisjonsfare
	Fare for å skjære seg
	Klemfare



## i Om dette dokumentet

Faresymbol	Betydning
	Fare på grunn av varme overflater
	Fare på grunn av sterkt magnetfelt
	Fare fra ikke-ioniserende stråling



Tabell 2: Faresymboler

### 1.2.3 Advarslenes struktur

Advarslene i dette dokumentet har standardisert utseende og standardisert struktur.



	 <b>Faretype og kilde til fare!</b> Mulige konsekvenser dersom fare/advarsel ignoreres. ▶ Tiltak og forbud for å forebygge fare.
--	--







Eksemplet nedenfor viser en advarsel mot elektrisk støt på grunn av strømførende deler. Tiltaket for å unngå faren er angitt.

	 <b>Fare for elektrisk støt på grunn av strømførende deler!</b> Død på grunn av drepende elektrisk støt ▶ Koble apparatene fra strømforsyningen i minst 60 sekunder før reparasjonene startes.
---	--

### 1.2.4 Generelle symboler

Følgende generelle symboler brukes i dette dokumentet:

Gen. symbol	Betydning
	Identifisering av et spesielt tips (tekst og/eller grafikk)
	Identifisering av et enkelt tips (kun tekst)
	Identifisering av en lenke til en opplæringsvideo

Gen. symbol	Betydning
	Identifisering av nødvendig verktøy
	Identifisering av nødvendige forutsetninger
	Identifisering av en betingelse (hvis ..., så ...)
	Identifisering av et resultat
	Identifisering av en tast eller knapp
	Identifisering av et materialnummer
	Identifisering av vist tekst/vindu (i apparatets display)

Tabell 3: Generelle symboler

## 2.1 Generelle sikkerhetsinstruksjoner

### 2.1.1 Alle husholdningsapparater

#### **Fare for elektrisk støt på grunn av strømførende deler!**

- Feil ved reparasjoner hvor elektriske komponenter er involvert, kan føre til elektrisk støt!
- Koble apparatet fra strømmettet i minst 60 sekunder før arbeidet startes.
- Etter reparasjonen må du sørge for at det utføres en sikkerhetstest iht. VDE 0701 eller gjeldende forskrifter i det respektive land.

#### **Fare for personskade på grunn av skarpe kanter!**

- Bruk vernehansker.

#### **Fare for å knuse legemsdeler under reparasjoner, vedlikehold, feilsøking og service på grunn av tunge og bevegelige komponenter**

- Bruk vernesko.
- Sikre tunge komponenter for å hindre at de faller ned.
- Ikke stikk kroppsdelene inn i bevegelige komponenter.

#### **Fare for apparatets sikkerhet/funksjon!**



- Bruk kun originale reservedeler.

#### **Fare for skade på deler som er følsomme overfor elektrostatisk utlading (ESD)!**

- Ikke berør modulene, inklusive tilkoblinger og ledere.



## Verktøy og hjelpemidler

Betegnelse	Detaljer	Bilder
Beskyttelsesklut [00342013]	60 cm x 50 cm	
Phillips-skrutrekker PH2		
Torx-bits TX20 [00340865]	6,3 mm (1/4")	
Flat skrutrekker	Blad 2,4 mm x 0,4 mm x 60 mm, i sett [00341820]	

## 4.1 Utskiftning av dørpakning

### Forutsetning:

- ✔ Døren er åpen.

### 4.1.1 Demontering av dørpakning

1. Løsne dørpakningen fra sporet i høyre og venstre hjørne.

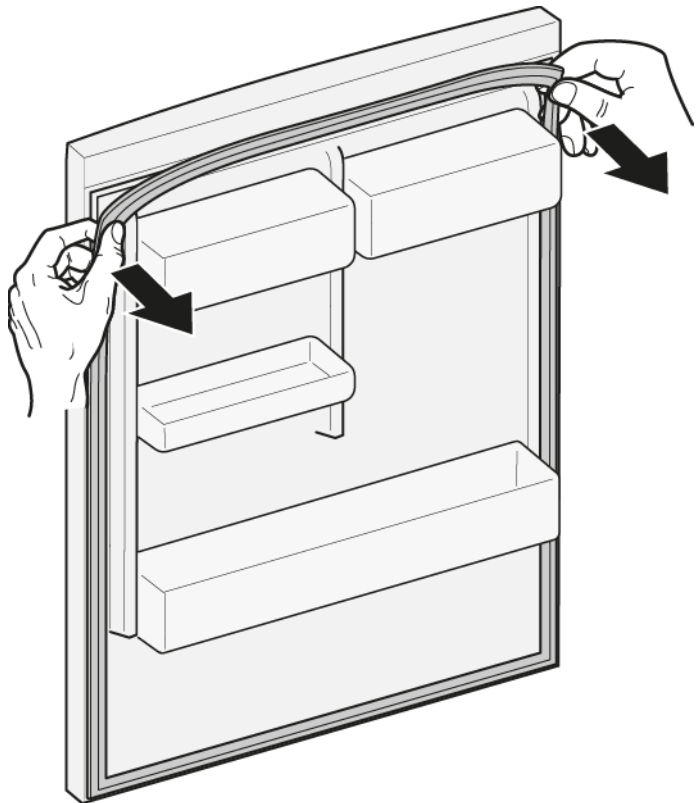

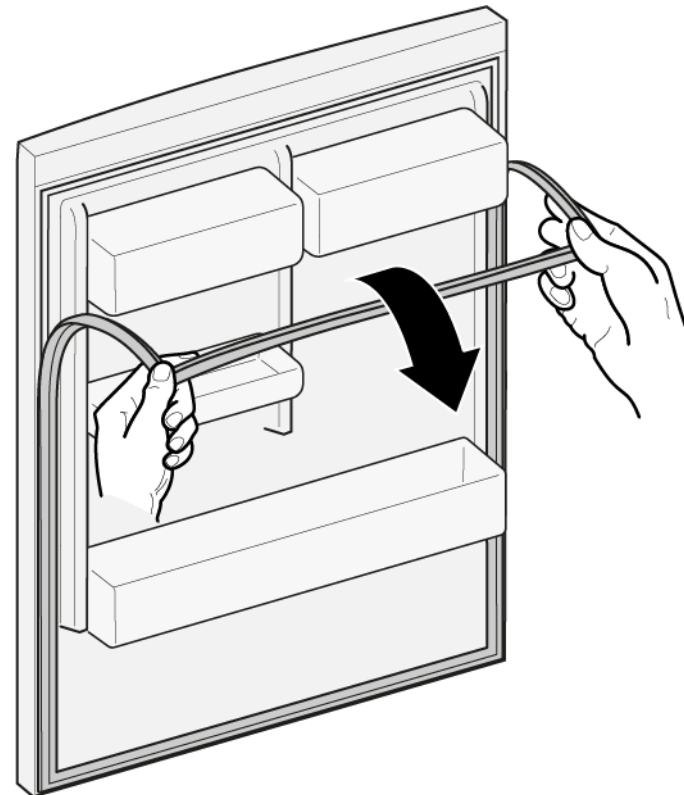

2. Trekk pakningen ut av sporet.



- ➡ Dørpakningen er demontert.

### 4.1.2 Montering av dørpakning

	Tykkelsen på den nye dørpakningen kan avvike litt fra tykkelsen på den gamle dørpakningen. Det har ingen innvirkning på lukkeatferd og langvarig funksjon.
	Hvis apparatet har justerbare hengsler eller hengslefester, kan du optimalisere lukkeatferden etterpå.
	Små sidehull i dørpakningen har en funksjon (nødvendige for ventilasjonen). Det dreier seg ikke om produksjonsfeil.

## Reparasjon

1. Kontroller at sporet for pakningen ikke har skader.

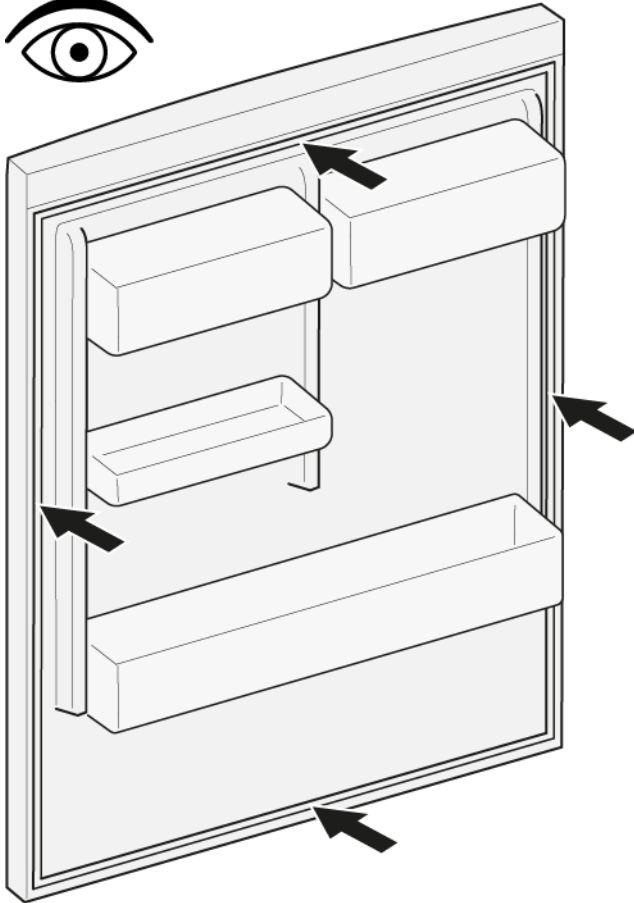

2.  Hvis sporet for pakningen er skadet:
  - Kontakt kundeservice.

3.  Litt deformasjon av dørpakningen er normalt og har ingen innvirkning på funksjonen. Det anbefales å rette ut dørpakningen før den settes inn i apparatet.

Varm opp dørpakningen med en føn eller varmt vann og form den på nytt med hendene.

4. Skyv pakningens hjørner øverst og nederst inn i sporet.

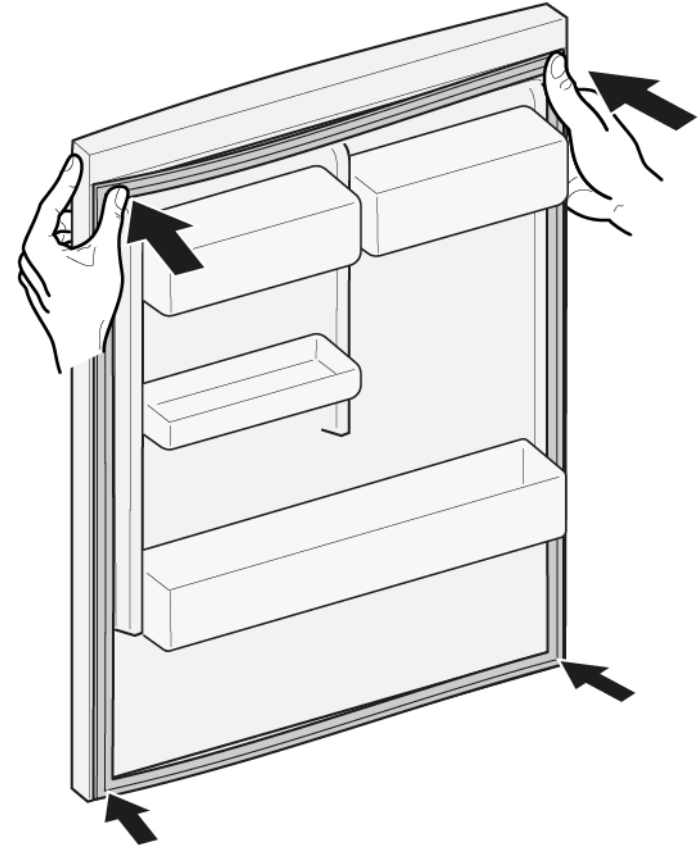

## Reparasjon

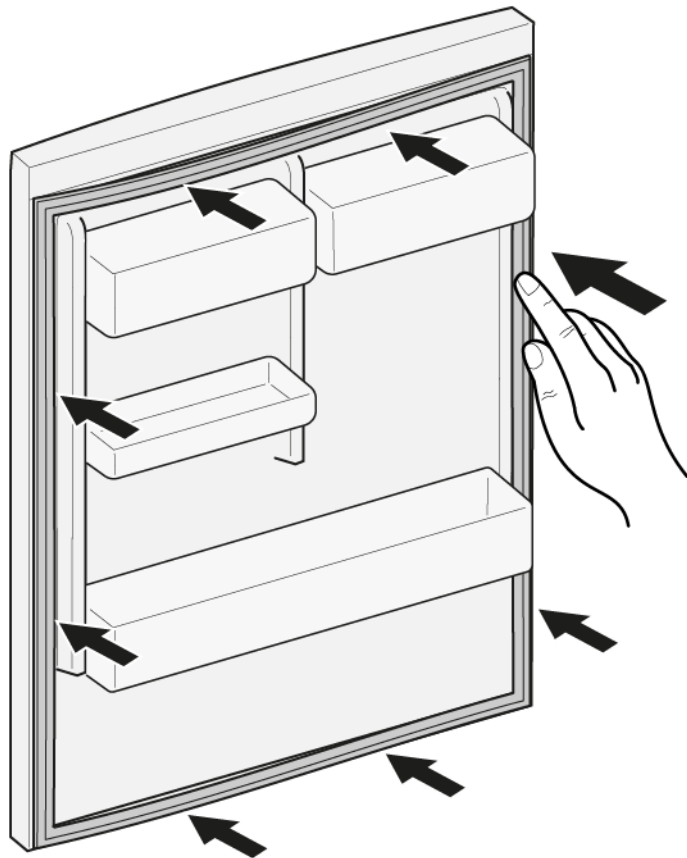

5. Trykk hele pakningen inn i sporet trinn for trinn.





 Dørpakningen er montert.

## 4.2 Utskiftning av dørhåndtak

### Spesielle hjelpemidler:

-  Torx-bits TX20                      6,3 mm (1/4")                      [00340865]
-  Flat skrutrekker                      Blad 10 mm x 1,6 mm x 200 mm

### Forutsetning:

-  Apparatet kobles fra strømforsyningen.
-  Døren er åpen.

### 4.2.1 Demontering av dørhåndtak

- ▶ 1. Fjern to skruhetter (1).
- ▶ 2. Skru ut to skruer (2).
- ▶ 3. Demonter dørhåndtaket (3).

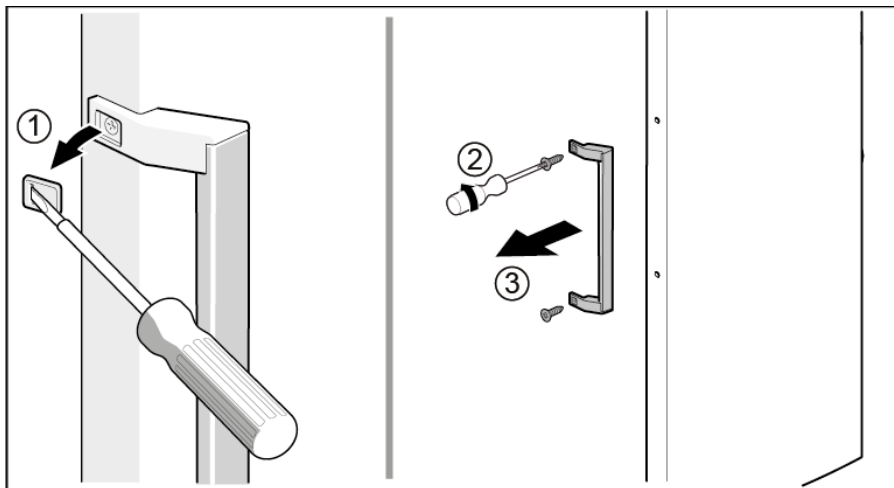

 Dørhåndtaket er demontert.

### 4.2.2 Montering av dørhåndtak

- ▶ Monteres i motsatt rekkefølge.

## 4.3 Utskiftning av easy opening handle

### Spesielle hjelpemidler:

- Phillips-skrutrekker PH2

### Forutsetning:

- Apparatet kobles fra strømforsyningen.
- Døren er åpen.

### 4.3.1 Demontering av easy opening handle

- 1. Ta av dekslet for easy opening handle (1).
- 2. Skru ut to skruer (2).

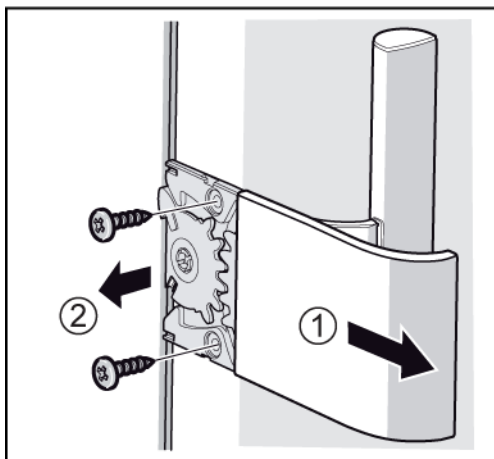

- easy opening handle er demontert.

## 4.3.2 Montering av easy opening handle

easy opening handle-mekanismen for enkel åpning skal stilles inn korrekt før montering.  
Korrekt plassering av støtstang (1), fortannede kvadranter (2) og (3), fjær (4) og grensebryter (5) for høyremontert dør er vist i grafikken.

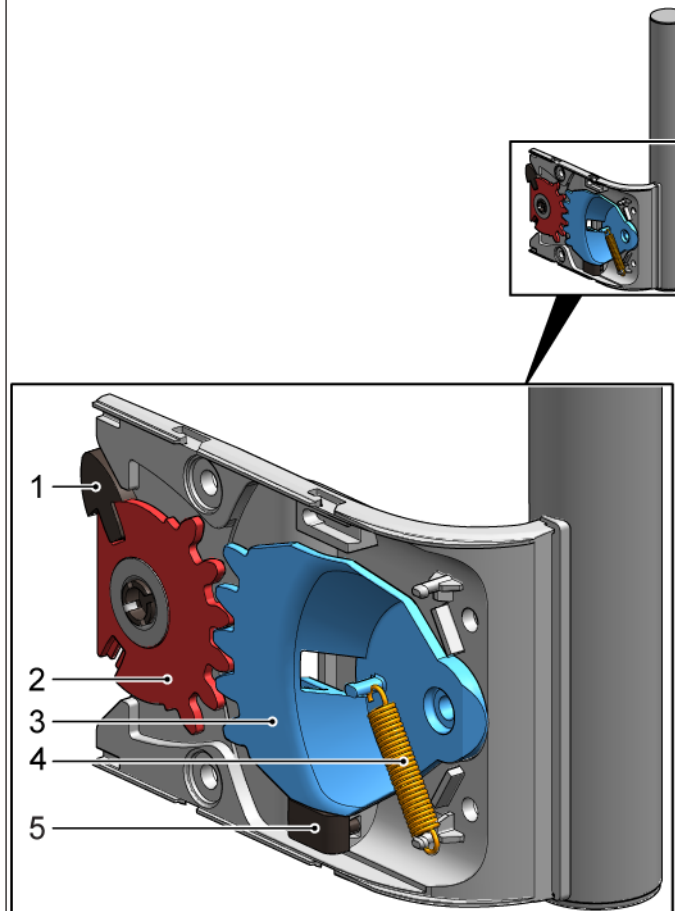

Plasseringen av underkomponentene til easy opening handle ved høyremontert dør er beskrevet i dokumentet "Monteringsanvisning".

- Monteres i motsatt rekkefølge.

## 4.4 Utskiftning av øvre dørhengsel

### Spesielle hjelpemidler:

 Torx-bits TX20                      6,3 mm (1/4")                      [00340865]

	<b>⚠ ADVARSEL</b>
	<b>Tunge, klumpete apparater!</b> Rygg- og muskelskader <ul style="list-style-type: none"><li>▶ Arbeidet med å demontere apparatets dør skal bare utføres av opplærte spesialister.</li><li>▶ Det kreves to personer for å flytte på apparatet.</li><li>▶ Bruk kun egnet verktøy og utstyr.</li></ul>

	<b>⚠ FORSIKTIG</b>
	<b>Skarpe kanter!</b> Kuttskader <ul style="list-style-type: none"><li>▶ Bruk vernehansker.</li></ul>

	<b>⚠ ADVARSEL</b>
	<b>Tiltede apparater kan skli ut!</b> Beinbrudd/klemskader <ul style="list-style-type: none"><li>▶ Sikre apparatene mot å skli ut.</li></ul>

	<b>⚠ FORSIKTIG</b>
	<b>Fare for at deler kan falle ned på grunn av løsnede skruer!</b> Personskade på grunn av fallende deler. <ul style="list-style-type: none"><li>▶ Sikre komponenten så den ikke kan falle ned.</li></ul>

	<b>OBS!</b>
	<b>Fare for at deler kan falle ned på grunn av løsnede skruer!</b> Skade på andre deler på apparatet eller i kundens hjem, f.eks. gulv. <ul style="list-style-type: none"><li>▶ Sikre komponenten så den ikke kan falle ned.</li></ul>

### Forutsetning:

- ✓ Apparatet kobles fra strømforsyningen.
- ✓ Apparatets innvendige beslag er demontert.

## 4.4.1 Demontering av dørhengsel

## Reparasjon

1. Plasser apparatet på baksiden.

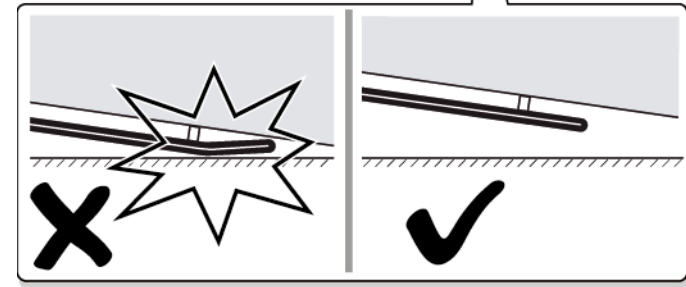
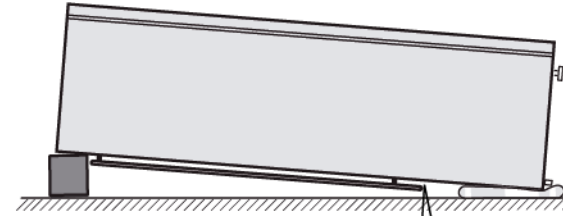
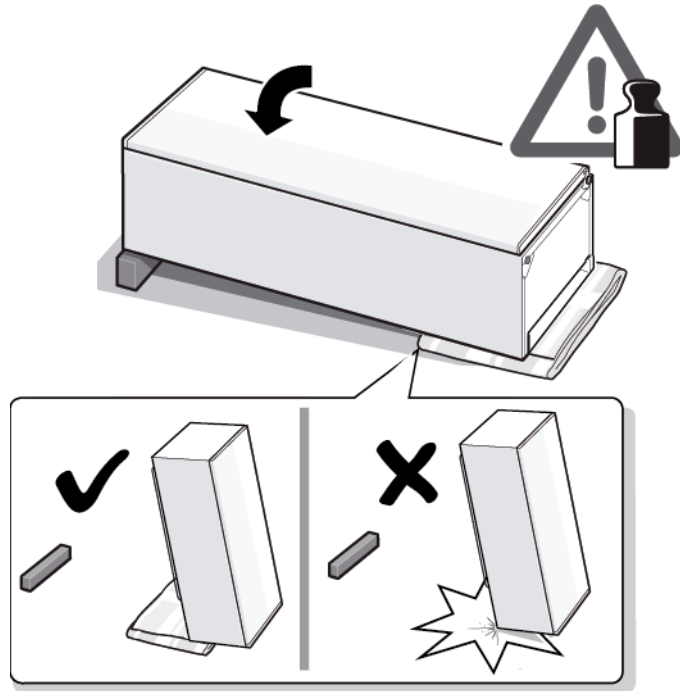

2. 1. Trykk inn det øvre hengseldekslet på begge sider (1).  
2. Beveg det øvre hengseldekslet ut (2).  
3. Ta av det øvre hengseldekslet (3).

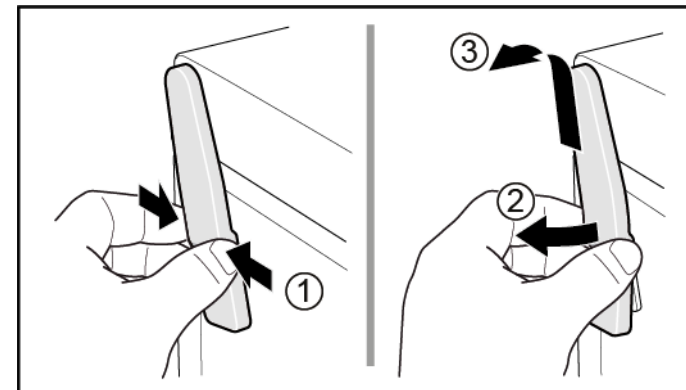



## Reparasjon

3.
  1. Skru ut to skruer (1).
  2. Demonter øvre hengsel (2).

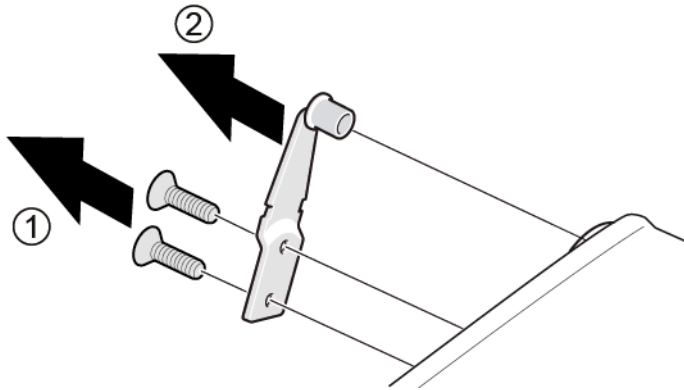

 Øvre dørhengsel er demontert.

### 4.4.2 Montering av dørhengsel



- ▶ Monteres i motsatt rekkefølge.

## 4.5 Utskiftning av øvre dørhengsel (dør med display)

### Spesielle hjelpemidler:

 Torx-bits TX20                      6,3 mm (1/4")                      [00340865]

	 <b>ADVARSEL</b>
	<p><b>Tunge, klumpete apparater!</b> Rygg- og muskelskader</p> <ul style="list-style-type: none"><li>▶ Arbeidet med å demontere apparatets dør skal bare utføres av opplærte spesialister.</li><li>▶ Det kreves to personer for å flytte på apparatet.</li><li>▶ Bruk kun egnet verktøy og utstyr.</li></ul>

	 <b>FORSIKTIG</b>
	<p><b>Skarpe kanter!</b> Kuttskader</p> <ul style="list-style-type: none"><li>▶ Bruk vernehansker.</li></ul>

	 <b>ADVARSEL</b>
	<p><b>Tiltede apparater kan skli ut!</b> Beinbrudd/klemskader</p> <ul style="list-style-type: none"><li>▶ Sikre apparatene mot å skli ut.</li></ul>



	 <b>FORSIKTIG</b>
	<p><b>Fare for at deler kan falle ned på grunn av løsnede skruer!</b> Personskade på grunn av fallende deler.</p> <ul style="list-style-type: none"><li>▶ Sikre komponenten så den ikke kan falle ned.</li></ul>

	<b>OBS!</b>
	<p><b>Fare for at deler kan falle ned på grunn av løsnede skruer!</b> Skade på andre deler på apparatet eller i kundens hjem, f.eks. gulv.</p> <ul style="list-style-type: none"><li>▶ Sikre komponenten så den ikke kan falle ned.</li></ul>

	 <b>FARE</b>
	<p><b>Fare for elektrisk støt på grunn av strømførende deler!</b> Livsfare på grunn av elektrisk støt ved feil reparasjon</p> <ul style="list-style-type: none"><li>▶ Elektriske deler skal repareres av kvalifiserte elektrikere.</li><li>▶ Etter reparasjonen må du sørge for at det utføres en sikkerhets-test iht. VDE 0701 eller gjeldende forskrifter i det respektive land.</li></ul>

	 <b>FARE</b>
	<p><b>Fare for elektrisk støt på grunn av strømførende deler!</b> Død på grunn av drepende elektrisk støt</p> <ul style="list-style-type: none"><li>▶ Koble apparatene fra strømforsyningen i minst 60 sekunder før reparasjonene startes.</li></ul>

### Forutsetning:

-  Apparatet kobles fra strømforsyningen.
-  Apparatets innvendige beslag er demontert.

## 4.5.1 Demontering av dørhengsel

1. Plasser apparatet på baksiden.

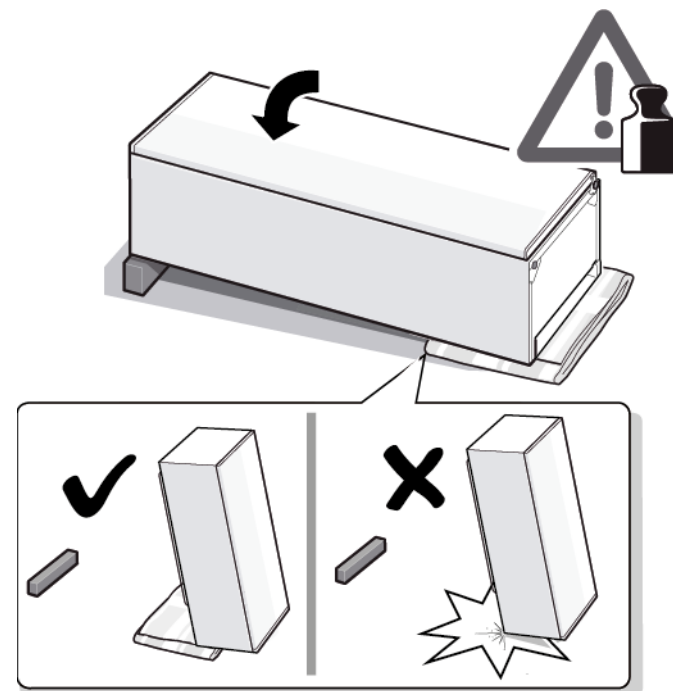

## Reparasjon

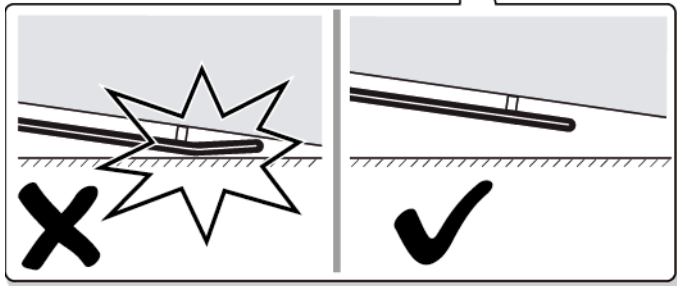
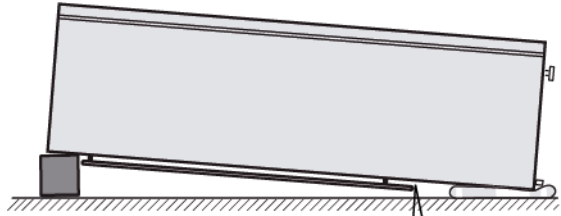

1. Trykk inn det øvre hengseldekslet på begge sider (1).
2. Beveg det øvre hengseldekslet ut (2).
3. Ta av det øvre hengseldekslet (3).

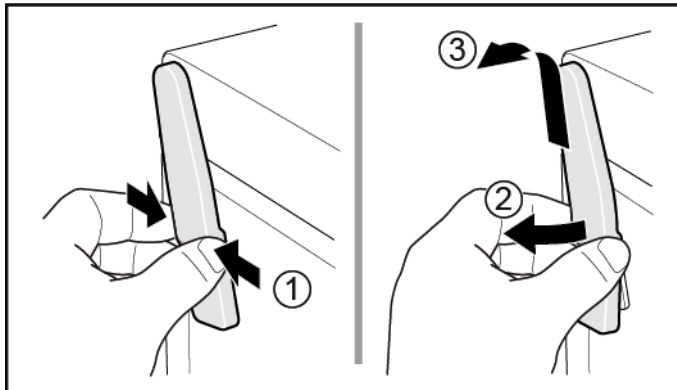

3. 1. Ta av kabelboksdekslet (1).
2. Fjern kabelbeskyttelsen (2).
3. Koble fra den elektriske tilkoblingen (3).
4. Skru ut to skruer (4).
5. Demonter øvre hengsel (5).

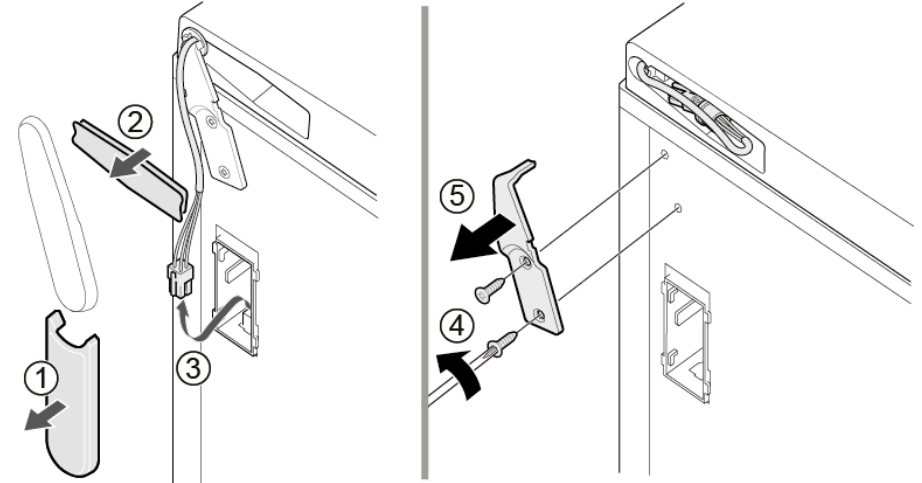

➔ Øvre dørhengsel er demontert.

### 4.5.2 Montering av dørhengsel

- ▶ Monteres i motsatt rekkefølge.

## 4.6 Utskiftning av nedre dørhengsel

### Spesielle hjelpemidler:

Torx-bits TX20

6,3 mm (1/4")

[00340865]

	<b>⚠ ADVARSEL</b> <b>Tunge, klumpete apparater!</b> Rygg- og muskelskader <ul style="list-style-type: none"><li>▶ Arbeidet med å demontere apparatets dør skal bare utføres av opplærte spesialister.</li><li>▶ Det kreves to personer for å flytte på apparatet.</li><li>▶ Bruk kun egnet verktøy og utstyr.</li></ul>
--	---

	<b>⚠ FORSIKTIG</b> <b>Skarpe kanter!</b> Kuttskader <ul style="list-style-type: none"><li>▶ Bruk vernehansker.</li></ul>
--	--

	<b>⚠ ADVARSEL</b> <b>Tiltede apparater kan skli ut!</b> Beinbrudd/klemskader <ul style="list-style-type: none"><li>▶ Sikre apparatene mot å skli ut.</li></ul>
--	--

	<b>⚠ FORSIKTIG</b> <b>Fare for at deler kan falle ned på grunn av løsnede skruer!</b> Personskade på grunn av fallende deler. <ul style="list-style-type: none"><li>▶ Sikre komponenten så den ikke kan falle ned.</li></ul>
---	--

	<b>OBS!</b> <b>Fare for at deler kan falle ned på grunn av løsnede skruer!</b> Skade på andre deler på apparatet eller i kundens hjem, f.eks. gulv. <ul style="list-style-type: none"><li>▶ Sikre komponenten så den ikke kan falle ned.</li></ul>
--	--

### Forutsetning:

- ✓ Apparatet kobles fra strømforsyningen.
- ✓ Apparatets innvendige beslag er demontert.
- ✓ Apparatet plasseres på baksiden.
- ✓ Øvre hengsel er demontert. → 354

### 4.6.1 Utskiftning av nedre dørhengsel

1. Demonter døren.

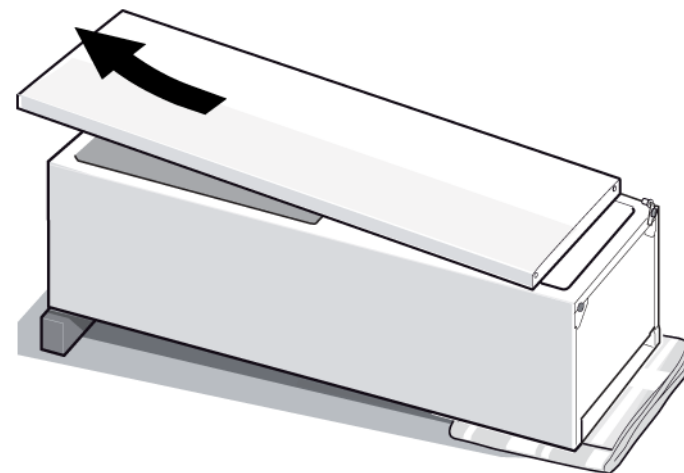

2. 1. Skru ut skruen (1).  
2. Drei den nedre hengselen ut (2).  
3. Demonter nedre hengsel (3).

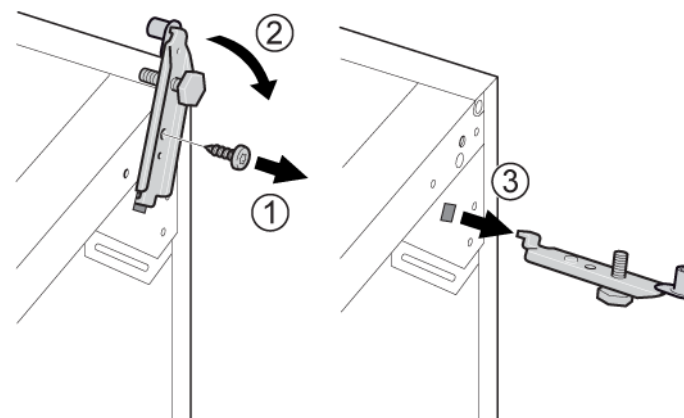

➡ Nedre hengsel er demontert.

### 4.6.2 Montering av nedre dørhengsel

- ▶ Monteres i motsatt rekkefølge.

## 4.7 Utskiftning av hylle

### Forutsetning:

- ✔ Døren er åpen.

### 4.7.1 Demontering av hylle

- ▶ Trekk ut hyllen.

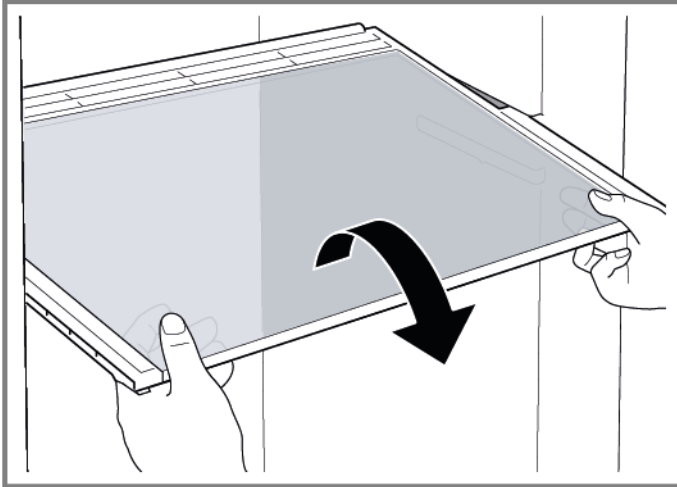

- ➡ Hyllen er demontert.

### 4.7.2 Montering av hylle

- ▶ Monteres i motsatt rekkefølge.

## 4.8 Utskiftning av beholdere for frysevarer

### Forutsetning:

- ✔ Døren er åpen.

### 4.8.1 Demontering av beholdere for frysevarer

- ▶ 1. Trekk beholderen for frysevarer helt ut (1).
- ▶ 2. Ta ut beholderen for frysevarer (2).

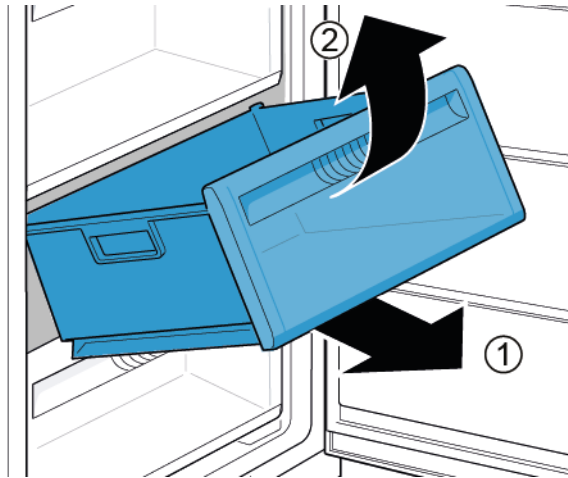

- ➡ Beholderen for frysevarer er demontert.

### 4.8.2 Montering av beholdere for frysevarer

- ▶ Monteres i motsatt rekkefølge.

## 4.9 Utskiftning av ismaskin

### Forutsetning:

- ✔ Døren er åpen.

### 4.9.1 Demontering av ismaskin

- ▶ 1. Trekk ut hyllen med beholderen for frysevarer med ismaskinen (1).
- ▶ 2. Løsne krokene (2).
- ▶ 3. Ta ut ismaskinen (3).

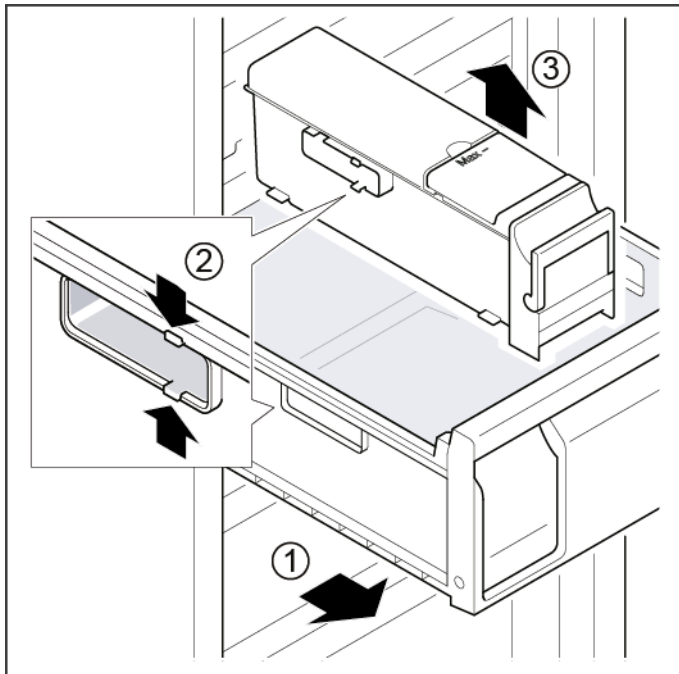

➡ Ismaskinen er demontert.

### 4.9.2 Montering av ismaskin

- ▶ Monteres i motsatt rekkefølge.



## 4.10 Utskiftning av øverste LED-lampe

### Spesielle hjelpemidler:

- Flat skrutrekker Blad 2,4 mm x 0,4 mm x 60 mm, i sett [00341820]

**i** Apparatet har en vedlikeholdsfri LED-lampe. Disse lampene skal kun repareres av kundeservice eller autoriserte teknikere!

**!** **FARE**  
**Fare for elektrisk støt på grunn av strømførende deler!**  
Livsfare på grunn av elektrisk støt ved feil reparasjon

- ▶ Elektriske deler skal repareres av kvalifiserte elektrikere.
- ▶ Etter reparasjonen må du sørge for at det utføres en sikkerhets-test iht. VDE 0701 eller gjeldende forskrifter i det respektive land.

**!** **FARE**  
**Fare for elektrisk støt på grunn av strømførende deler!**  
Død på grunn av drepende elektrisk støt

- ▶ Koble apparatene fra strømforsyningen i minst 60 sekunder før reparasjonene startes.

**!** **FORSIKTIG**  
**Skarpe kanter!**  
Kuttskader

- ▶ Bruk vernehansker.

### Forutsetning:

- ✓ Apparatet kobles fra strømforsyningen.
- ✓ Døren er åpen.
- ✓ De øvre innvendige beslagene er demontert.

### 4.10.1 Demontering av LED-lampe

1. Beveg LED-lampen over til venstre side.



- ➡ LED-lampens elektriske tilkobling kobles fra.

2. Løsne LED-lampens kroker.

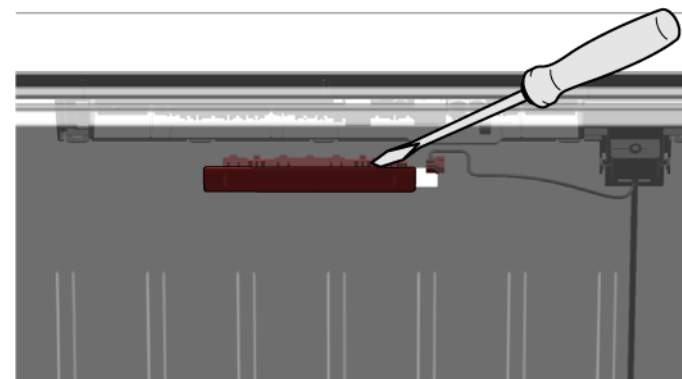

## Reparasjon

3. Demonter LED-lampen ved å bevege den forover.

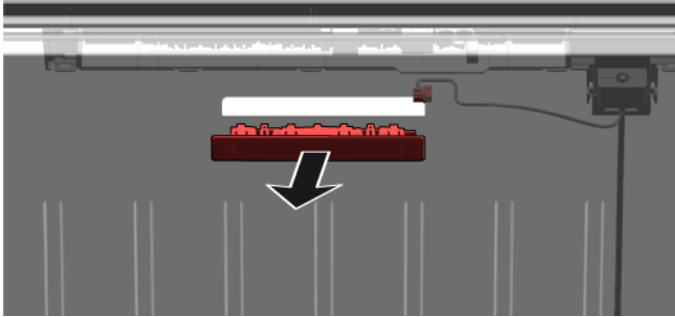

- ➔ LED-lampen er demontert.

### 4.10.2 Montering av øverste LED-lampe

- ▶ Monteres i motsatt rekkefølge.

# Wskazówki naprawy - Zamrażarka

## Informacje dotyczące dokumentu ..... 364

1.1	Ważne informacje.....	364
1.1.1	Cel dokumentu .....	364
1.2	Objaśnienie symboli ostrzegawczych.....	364
1.2.1	Oznaczenie poziomów niebezpieczeństwa .....	364
1.2.2	Symbole ostrzegawcze.....	364
1.2.3	Budowa ostrzeżeń .....	365
1.2.4	Ogólne symbole.....	365

## Bezpieczeństwo..... 366

2.1	Ogólne informacje dotyczące bezpieczeństwa.....	366
2.1.1	Wszystkie sprzęty gospodarstwa domowego .....	366

## Narzędzia i pomoce techniczne..... 367

## Naprawy..... 368

4.1	Wymiana uszczelki drzwiczek .....	368
4.1.1	Demontaż uszczelki drzwiczek.....	368
4.1.2	Montaż uszczelki drzwiczek.....	368
4.2	Wymiana uchwyty drzwiczek.....	371
4.2.1	Demontaż uchwyty drzwiczek .....	371
4.2.2	Montaż uchwyty drzwiczek .....	371
4.3	Wymiana uchwyty Easy Opening Handle.....	372
4.3.1	Demontaż uchwyty Easy Opening Handle .....	372
4.3.2	Montaż uchwyty Easy Opening Handle .....	372
4.4	Wymiana górnego zawiasu drzwiczek.....	373
4.4.1	Demontaż zawiasu drzwiczek .....	373
4.4.2	Montaż zawiasu drzwiczek .....	375
4.5	Wymiana górnego zawiasu drzwiczek (drzwiczki z wyświetlaczem).....	376
4.5.1	Demontaż zawiasu drzwiczek .....	377
4.5.2	Montaż zawiasu drzwiczek .....	378
4.6	Wymiana dolnego zawiasu drzwiczek .....	379
4.6.1	Wymiana dolnego zawiasu drzwiczek.....	379
4.6.2	Montaż dolnego zawiasu drzwiczek.....	380
4.7	Wymiana półki.....	381
4.7.1	Demontaż półki .....	381
4.7.2	Montaż półki .....	381

4.8	Wymiana pojemnika na mrożoną żywność .....	382
4.8.1	Demontaż pojemnika na mrożoną żywność.....	382
4.8.2	Montaż pojemnika na mrożoną żywność.....	382
4.9	Wymiana kostkarki do lodu .....	383
4.9.1	Demontaż kostkarki do lodu .....	383
4.9.2	Montaż kostkarki do lodu .....	383
4.10	Wymiana górnego oświetlenia LED .....	384
4.10.1	Demontaż oświetlenia LED .....	384
4.10.2	Montaż górnego oświetlenia LED .....	385

# **i** Informacje dotyczące dokumentu

## 1.1 Ważne informacje

### 1.1.1 Cel dokumentu

Niniejsze wskazówki naprawcze mają na celu zapewnienie użytkownikowi pomocy w samodzielnej naprawie posiadanych urządzeń w sposób zgodny z obowiązującymi przepisami w sprawie ekoprojektu (stan na 03/2021).

Zawierają one informacje na temat wymiany określonych części zamiennych oraz ostrzeżenia i informacje o zagrożeniach.

W razie pytań należy się skontaktować z naszym działem serwisowym. Odpowiedzialność za szkody ponosimy tylko pod warunkiem prawidłowego stosowania się do wskazówek naprawczych.

## 1.2 Objasnienie symboli ostrzegawczych

### 1.2.1 Oznaczenie poziomów niebezpieczeństwa

Poziom ryzyka jest określany przy pomocy symbolu oraz wyrazu. Wyraz określa poziom ryzyka.



Symbol	Znaczenie
 <b>NIEBEZPIECZEŃSTWO</b>	Bezpośrednio zagrażające niebezpieczeństwo, które przy niezachowaniu odpowiednich środków ostrożności może doprowadzić do śmierci lub poważnych obrażeń.
 <b>OSTRZEŻENIE</b>	Prawdopodobieństwo wystąpienia niebezpieczeństwa, które przy niezachowaniu odpowiednich środków ostrożności może doprowadzić do śmierci lub poważnych obrażeń.
 <b>WAŻNE</b>	Prawdopodobieństwo wystąpienia niebezpieczeństwa, które przy niezachowaniu odpowiednich środków ostrożności może doprowadzić do powstania lekkich obrażeń.
<b>UWAGA!</b>	Ostrzeżenie dot. możliwości powstania szkody materialnej.

Tabela 1: Oznaczenie poziomów niebezpieczeństwa

### 1.2.2 Symbole ostrzegawcze

Symbole ostrzegawcze reprezentują graficznie źródło potencjalnego ryzyka.

W poniższym dokumencie użyto następujących symboli:

Symbole ostrzegawcze	Znaczenie
	Ogólne ostrzeżenie
	Niebezpieczeństwo od napięcia elektrycznego
	Ryzyko wybuchu

## **i** Informacje dotyczące dokumentu







Symbole ostrzegawcze	Znaczenie
	Ryzyko obrażeń (rozcięć)
	Ryzyko zmiżdżenia
	Ryzyko oparzenia
	Silne pole magnetyczne
	Promieniowanie nie-jonizujące

Tabela 2: Symbole ostrzegawcze

### 1.2.3 Budowa ostrzeżeń

Ostrzeżenia podane w dokumencie mają standardową budowę.

	<p><b>⚠ NIEBEZPIECZEŃSTWO</b></p> <p><b>Typ i źródło ryzyka!!</b> Konsekwencje zignorowania.</p> <ul style="list-style-type: none"> <li>▶ Środki ochronne.</li> </ul>
---	---

Kolejne ostrzeżenie wskazuje, jako źródło możliwość porażenia prądem. Wskazano czynności, które mają za zadanie ograniczenie ryzyka.

	<p><b>⚠ NIEBEZPIECZEŃSTWO</b></p> <p><b>Ryzyko porażenia prądem, ze względu na elementy będące pod napięciem!</b> Zagrożenie życia poprzez porażenie prądem</p> <ul style="list-style-type: none"> <li>▶ Odłączyć urządzenie od zasilania sieciowego na 60 sekund przed rozpoczęciem naprawy.</li> </ul>
--	--

### 1.2.4 Ogólne symbole

Poniższe symbole są używane w dokumentacji:







Symbol	Znaczenie
	Identyfikacja specjalnej wskazówki (tekst lub grafika)
	Identyfikacja prostej wskazówki (tylko tekst)
	Identyfikacja linku do pliku wideo
	Identyfikacja narzędzi
	Identyfikacja wstępnych warunków
	Identyfikacja warunku (jeżeli)
	Identyfikacja rezultatu
[Start]	Identyfikacja przycisku
[00123456]	Identyfikacja numeru materiału
Status	Identyfikacja wyświetlanego tekstu / komunikatu (na wyświetlaczu)

Tabela 3: Ogólne symbole

## **2.1 Ogólne informacje dotyczące bezpieczeństwa**

### **2.1.1 Wszystkie sprzęty gospodarstwa domowego**

#### **Ryzyko porażenia prądem elektrycznym wskutek kontaktu z elementami znajdującymi się pod napięciem!**

- Błędna naprawa części elektrycznych może spowodować porażenie prądem elektrycznym!
- Co najmniej 60 sekund przed przystąpieniem do pracy odłączyć urządzenie od sieci elektrycznej.
- Po naprawie należy przeprowadzić test bezpieczeństwa zgodny z przepisami normy VDE 0701 (Niemcy) lub odpowiednimi przepisami obowiązującymi w kraju użytkowania.

#### **Ryzyko zranienia o ostre krawędzie!**

- Używać rękawic ochronnych.

#### **Ryzyko zmiążdżenia podczas naprawy, obsługi lub diagnozy, ze względu na ciężkie i ruchome elementy**

- Stosować obuwie ochronne.
- Zabezpieczyć ciężkie elementy przed upadkiem.
- Nie dotykać ruchomych elementów podczas pracy urządzenia.



#### **Zagrożenie dla bezpieczeństwa użytkownika i działania urządzenia!**

- Używać tylko oryginalnych części zamiennych.

#### **Ryzyko uszkodzenia komponentów wrażliwych na wyładowania elektrostatyczne (ESD)!**

- Nie dotykać modułów, włącznie ze złączami i ścieżkami przewodzącymi.

## Narzędzia i pomoce techniczne

Przeznaczenie	Detale	Zdjęcia
Tkanina ochronna [00342013]	60 cm x 50 cm	
Wkrętak krzyżowy PH2		
Torx Bit TX20 [00340865]	6,3 mm (1/4")	
Śrubokręt z końcówką płaską	Końcówka 2,4 mm x 0,4 mm x 60 mm, w zestawie [00341820]	

## 4.1 Wymiana uszczelki drzwiczek

### Warunek:

- ✔ Drzwiczki są otwarte.

### 4.1.1 Demontaż uszczelki drzwiczek

1. Poluzować uszczelkę drzwiczek w rowku w prawym i lewym narożniku.

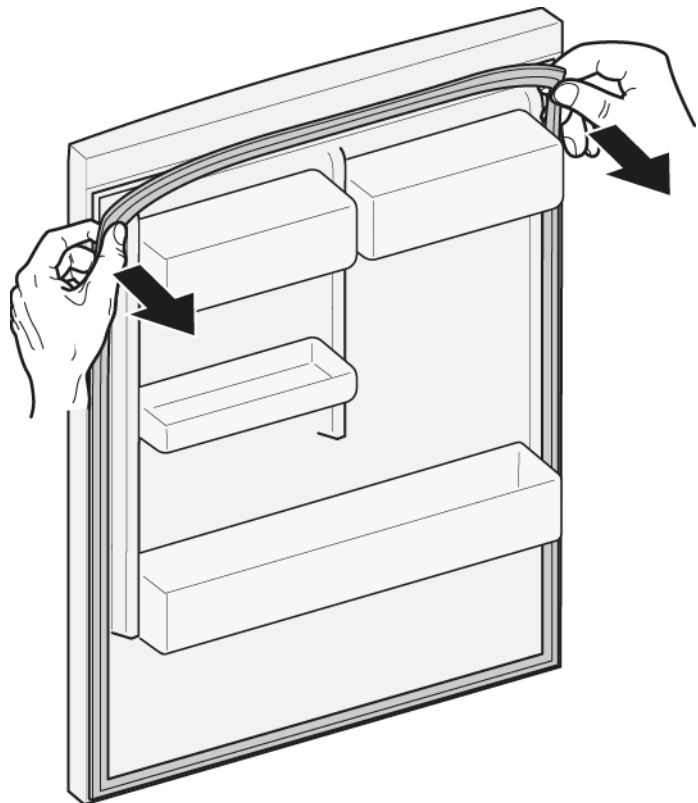

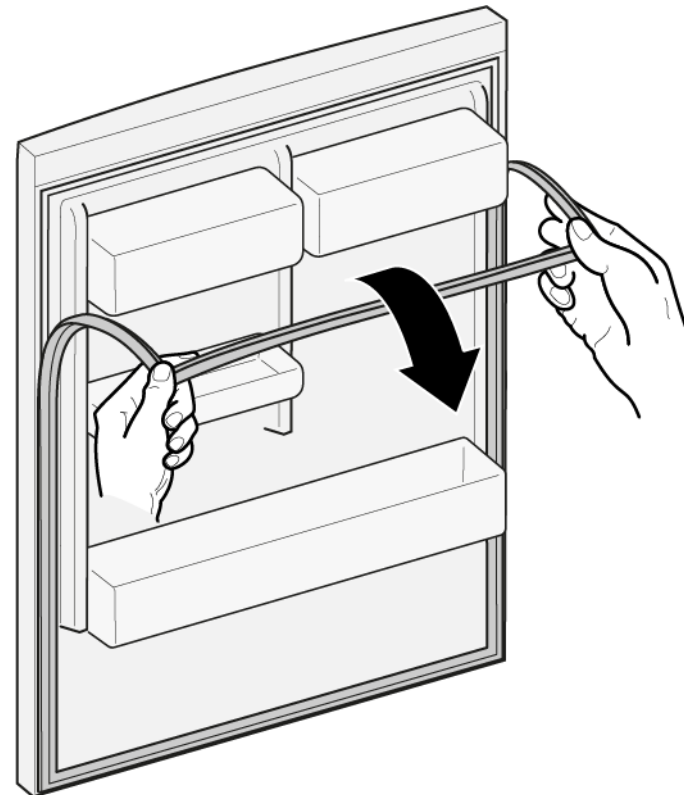

2. Wyciągnąć uszczelkę drzwiczek z rowka.



- ➡ Uszczelka drzwiczek została zdemontowana.

### 4.1.2 Montaż uszczelki drzwiczek

	Grubość nowej uszczelki drzwiczek może się nieco różnić od grubości starej uszczelki drzwiczek. Nie ma to wpływu na jakość zamykania drzwiczek i i działanie urządzenia.
	Jeżeli urządzenie posiada regulowane zawiasy lub elementy mocujące zawiasów, można przy ich użyciu regulować sposób zamykania drzwiczek.
	Małe boczne otwory w uszczelce drzwiczek są elementami funkcyjnymi (zapewniają wentylację). Nie stanowią one wad produkcyjnych.



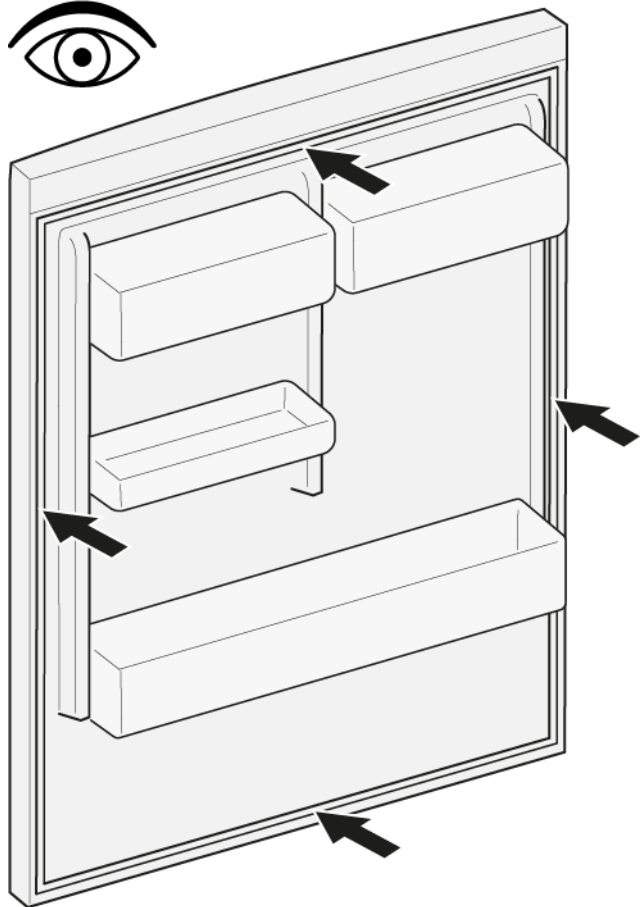

1. Skontrolować rowek uszczelki pod kątem uszkodzeń.

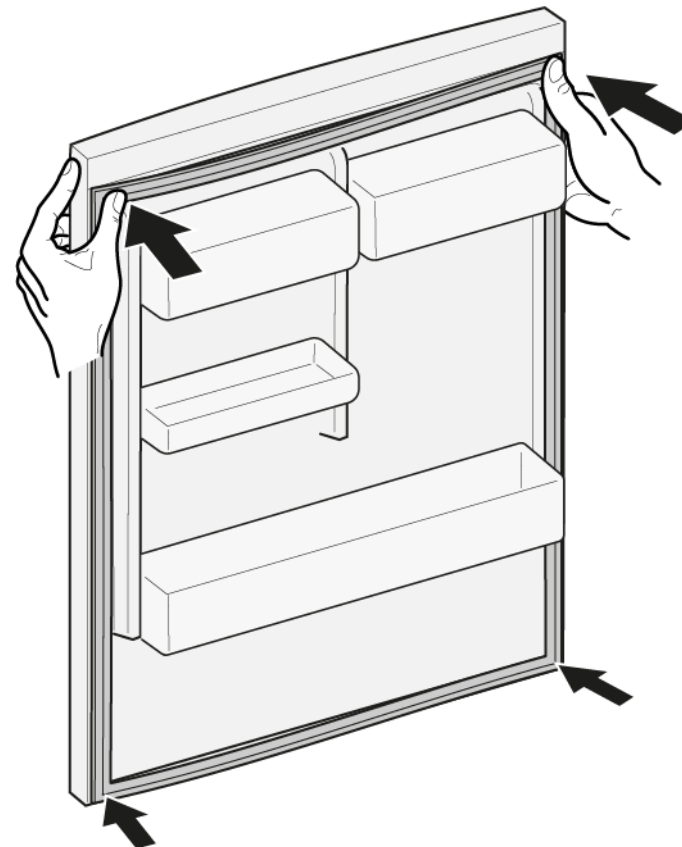

4. Wcisnąć narożniki uszczelki do rowka u dołu i u góry.



2.  Jeżeli rowek uszczelki jest uszkodzony.  
- Skontaktować się z serwisem.

3.  Lekka deformacja uszczelki drzwiczek jest normalna i nie wpływa na jej funkcję. Zaleca się wyprostowanie uszczelki drzwiczek przed jej zamocowaniem w urządzeniu.

Ogrzać uszczelkę drzwiczek suszarką do włosów lub nadać jej żądany kształt rękami.

## Naprawy

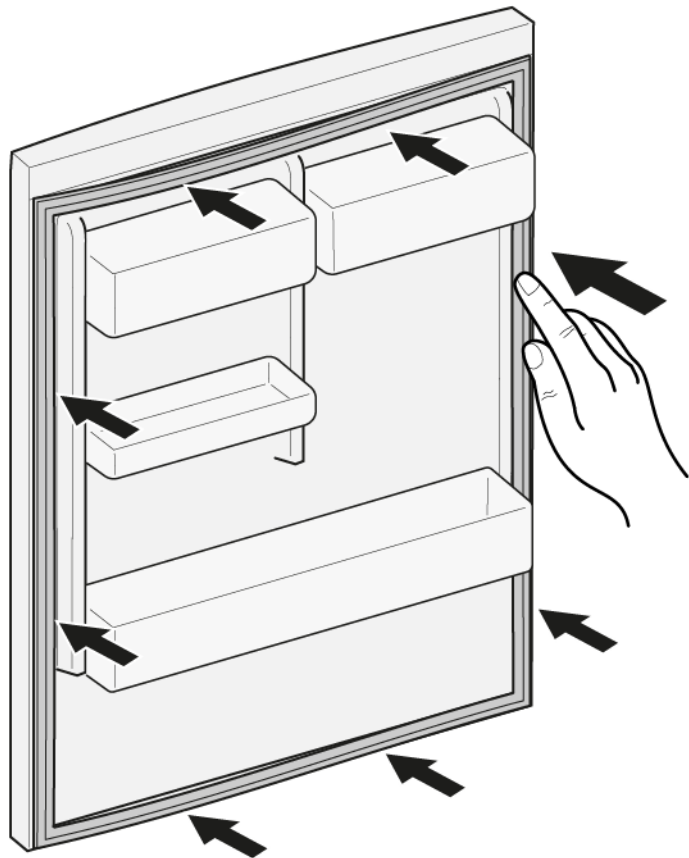

5. Krok po kroku wcisnąć uszczelkę do rowka na całym obwodzie.





 Uszczelka drzwiczek została zamontowana.

## 4.2 Wymiana uchwyty drzwiczek

### Pomoce specjalne

-  Torx Bit TX20                      6,3 mm (1/4")                      [00340865]
-  Śrubokręt z końcówką płaską      Końcówka 10 mm x 1,6 mm x  
200 mm

### Warunek:

-  Urządzenie jest odłączone od źródła zasilania energią elektryczną.
-  Drzwiczki są otwarte.

### 4.2.1 Demontaż uchwyty drzwiczek

- ▶ 1. Wykręcić dwie zaślepki gwintowane (1).
- 2. Wykręcić dwie śruby (2).
- 3. Zdjąć uchwyt drzwiczek (3).

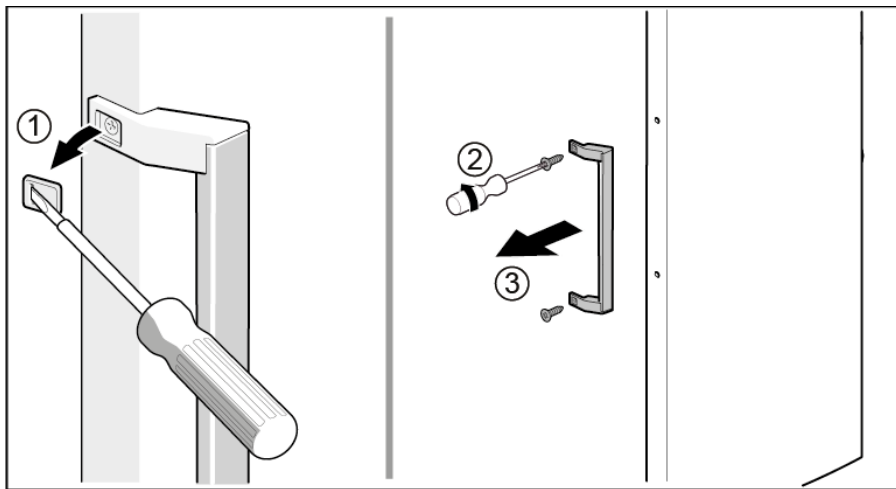

-  Uchwyt drzwiczek został zdemontowany.

### 4.2.2 Montaż uchwyty drzwiczek

- ▶ Montaż w odwrotnej kolejności.

## 4.3 Wymiana uchwyty Easy Opening Handle

### Pomoce specjalne

- Wkrętak krzyżowy PH2

### Warunek:

- Urządzenie jest odłączone od źródła zasilania energią elektryczną.
- Drzwiczki są otwarte.

### 4.3.1 Demontaż uchwyty Easy Opening Handle

1. Zdjąć osłonę uchwyty Easy Opening Handle (1).
2. Wykręcić dwie śruby (2).

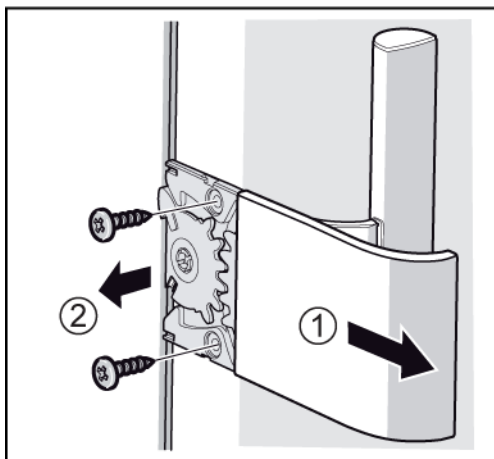

- Uchwyt drzwiczek Easy Opening Handle jest zdemontowany.

### 4.3.2 Montaż uchwyty Easy Opening Handle

Mechanizm uchwyty Easy Opening Handle należy przed montażem prawidłowo ustawić.

Prawidłowe ustawienie popychacza (1), zębatek (2) i (3), sprężyny (4) i ogranicznika ruchu (5) dla drzwiczek zmontowanych lewostronnie jest pokazane na ilustracji.

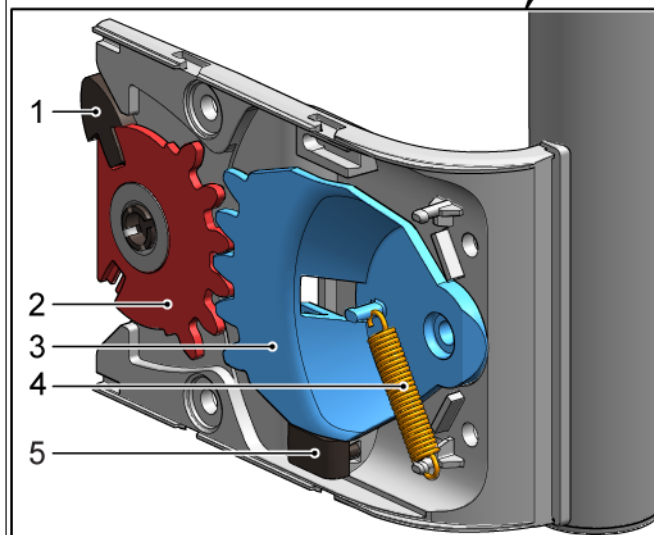
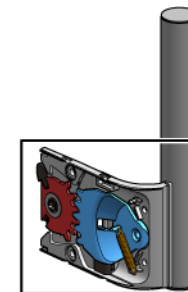

Ustawienie elementów uchwyty Easy Opening Handle dla drzwiczek zmontowanych prawostronnie jest pokazane w dokumencie "Instrukcja montażu".

- Montaż w odwrotnej kolejności.

## 4.4 Wymiana górnego zawiasu drzwiczek

### Pomoce specjalne

 Torx Bit TX20                      6,3 mm (1/4")                      [00340865]

	<b>⚠ OSTRZEŻENIE</b>
	<b>Ciężkie, nieporęczne urządzenia!</b> Kontuzje mięśni i pleców <ul style="list-style-type: none"><li>▶ Czynność demontażu drzwiczek urządzenia powinna być wykonywana tylko przez wyszkolonych techników.</li><li>▶ Przemieszczenie urządzenia wymaga udziału dwóch osób.</li><li>▶ Używać tylko odpowiednich narzędzi i sprzętu.</li></ul>

	<b>⚠ WAŻNE</b>
	<b>Ostre krawędzie!</b> Rany cięte <ul style="list-style-type: none"><li>▶ Zawsze używaj rękawic ochronnych.</li></ul>

	<b>⚠ OSTRZEŻENIE</b>
	<b>Możliwość wyslizgnięcia się przechylonego urządzenia!</b> Złamania kości / zmiżdżenia <ul style="list-style-type: none"><li>▶ Zabezpieczyć urządzenia przed wyslizgnięciem.</li></ul>

	<b>⚠ WAŻNE</b>
	<b>Niebezpieczeństwo spadnięcia części po wykręceniu śrub!</b> Zranienie przez spadające części. <ul style="list-style-type: none"><li>▶ Zabezpieczyć część przed spadnięciem.</li></ul>

	<b>UWAGA!</b>
	<b>Niebezpieczeństwo spadnięcia części po wykręceniu śrub!</b> Uszkodzenie innych części urządzenia albo pomieszczenia mieszkalnego, np. podłogi. <ul style="list-style-type: none"><li>▶ Zabezpieczyć część przed spadnięciem.</li></ul>

### Warunek:

- ✔ Urządzenie jest odłączone od źródła zasilania energią elektryczną.
- ✔ Zostały zdemontowane wewnętrzne elementy mocujące urządzenia.

## 4.4.1 Demontaż zawiasu drzwiczek

1. Położyć urządzenie "na plecach".

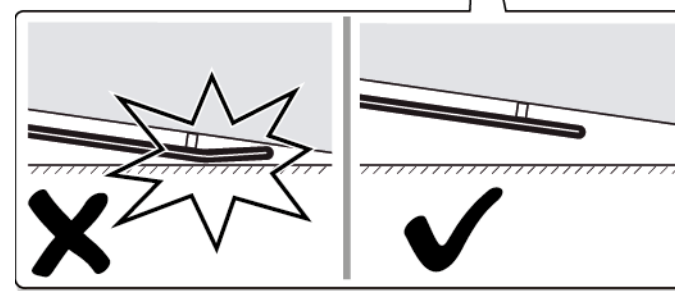
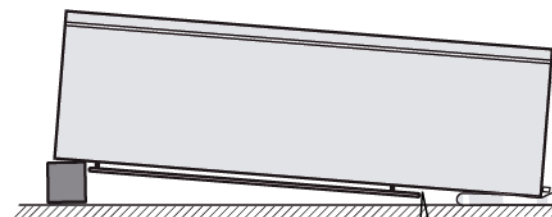
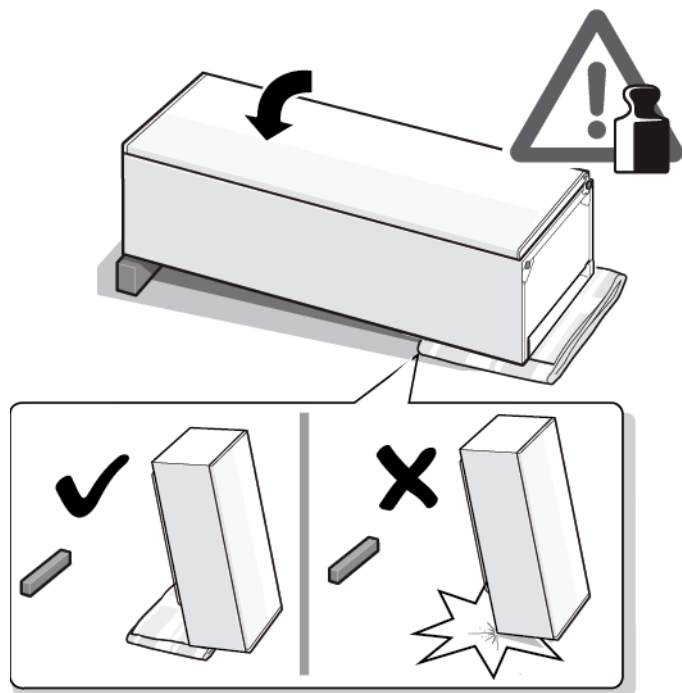

2. 1. Nacisnąć osłony zawiasów górnych po obu stronach (1).  
2. Przesunąć osłonę zawiasu górnego (2).  
3. Zdjąć osłonę zawiasu górnego (3).

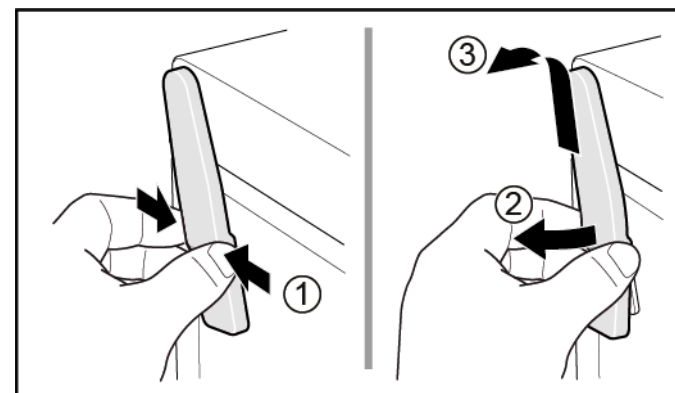

## Naprawy

3. 1. Wykręcić dwie śruby (1).
2. Wyjąć zawias górny (2).

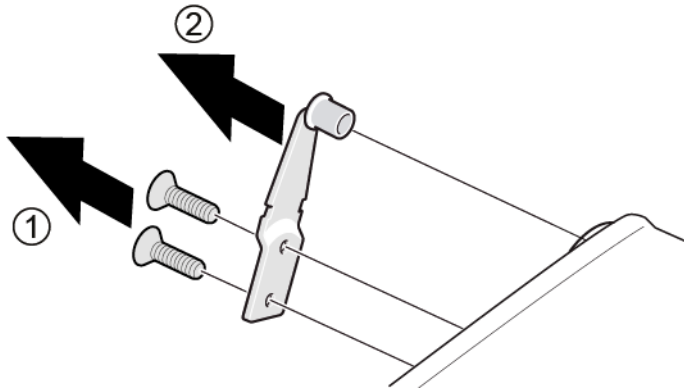

 Górny zawias drzwiczek jest zdemontowany.

### 4.4.2 Montaż zawiasu drzwiczek

- ▶ Montaż w odwrotnej kolejności.

## 4.5 Wymiana górnego zawiasu drzwiczek (drzwiczki z wyświetlaczem)

### Pomoce specjalne

 Torx Bit TX20      6,3 mm (1/4")      [00340865]

	<b>⚠ OSTRZEŻENIE</b>
	<p><b>Ciężkie, nieporęczne urządzenia!</b> Kontuzje mięśni i pleców</p> <ul style="list-style-type: none"> <li>▶ Czynność demontażu drzwiczek urządzenia powinna być wykonywana tylko przez wyszkolonych techników.</li> <li>▶ Przemieszczenie urządzenia wymaga udziału dwóch osób.</li> <li>▶ Używać tylko odpowiednich narzędzi i sprzętu.</li> </ul>

	<b>⚠ WAŻNE</b>
	<p><b>Ostre krawędzie!</b> Rany cięte</p> <ul style="list-style-type: none"> <li>▶ Zawsze używaj rękawic ochronnych.</li> </ul>

	<b>⚠ OSTRZEŻENIE</b>
	<p><b>Możliwość wyslizgnięcia się przechylonego urządzenia!</b> Złamania kości / zmiążdżenia</p> <ul style="list-style-type: none"> <li>▶ Zabezpieczyć urządzenia przed wyslizgnięciem.</li> </ul>



	<b>⚠ WAŻNE</b>
	<p><b>Niebezpieczeństwo spadnięcia części po wykręceniu śrub!</b> Zranienie przez spadające części.</p> <ul style="list-style-type: none"> <li>▶ Zabezpieczyć część przed spadnięciem.</li> </ul>

	<b>UWAGA!</b>
	<p><b>Niebezpieczeństwo spadnięcia części po wykręceniu śrub!</b> Uszkodzenie innych części urządzenia albo pomieszczenia mieszkalnego, np. podłogi.</p> <ul style="list-style-type: none"> <li>▶ Zabezpieczyć część przed spadnięciem.</li> </ul>

	<b>⚠ NIEBEZPIECZEŃSTWO</b>
	<p><b>Ryzyko porażenia prądem elektrycznym wskutek kontaktu z elementami znajdującymi się pod napięciem!</b> Niebezpieczeństwo utraty życia wskutek porażenia prądem elektrycznym w przypadku nieprawidłowej naprawy</p> <ul style="list-style-type: none"> <li>▶ Części elektryczne powinny być naprawiane przez wykwalifikowanych elektryków.</li> <li>▶ Po naprawie należy przeprowadzić test bezpieczeństwa zgodny z przepisami normy VDE 0701 (Niemcy) lub odpowiednimi przepisami obowiązującymi w kraju użytkowania.</li> </ul>

	<b>⚠ NIEBEZPIECZEŃSTWO</b>
	<p><b>Ryzyko porażenia prądem, ze względu na elementy będące pod napięciem!</b> Zagrożenie życia poprzez porażenie prądem</p> <ul style="list-style-type: none"> <li>▶ Odłączyć urządzenie od zasilania sieciowego na 60 sekund przed rozpoczęciem naprawy.</li> </ul>

### Warunek:

-  Urządzenie jest odłączone od źródła zasilania energią elektryczną.
-  Zostały zdemontowane wewnętrzne elementy mocujące urządzenia.



## 4.5.1 Demontaż zawiasu drzwiczek

1. Położyć urządzenie "na plecach".

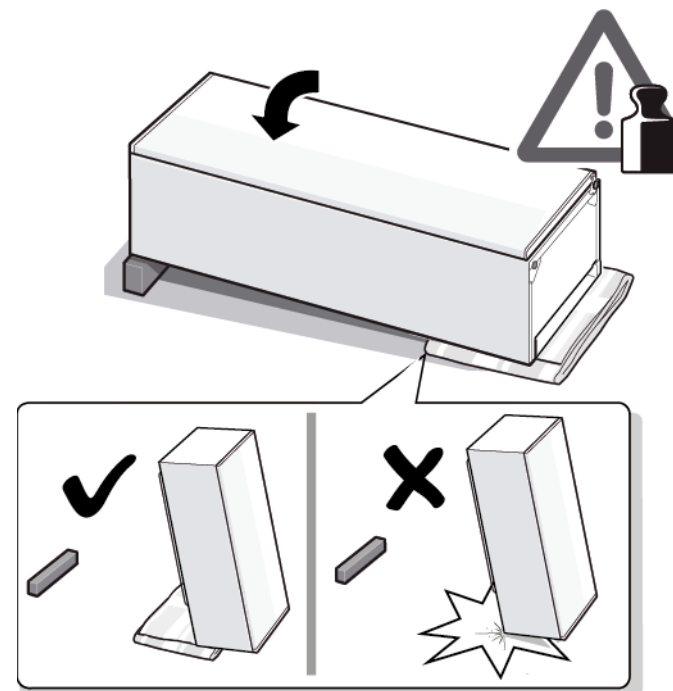

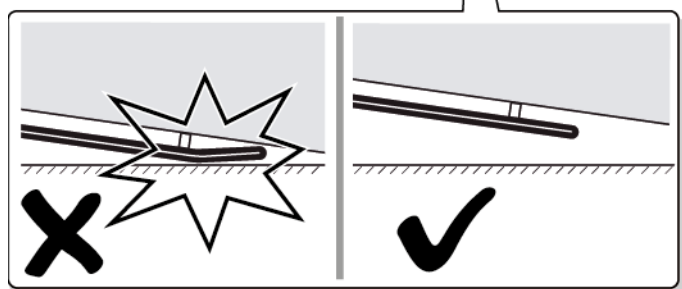
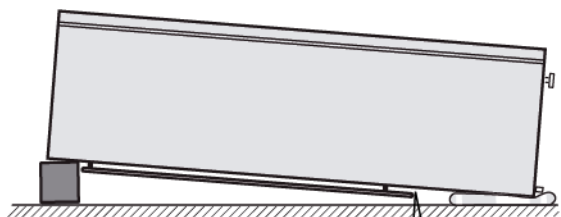

2. 1. Nacisnąć osłony zawiasów górnych po obu stronach (1).
2. Przesunąć osłonę zawiasu górnego (2).
3. Zdjąć osłonę zawiasu górnego (3).

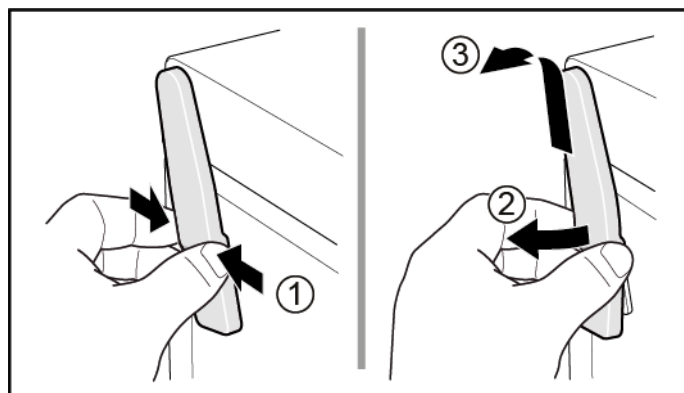

3. 1. Zdjąć pokrywę puszki kablowej (1).
2. Wyjąć osłonę kabli (2).
3. Odłączyć złącze elektryczne (3).
4. Wykręcić dwie śruby (4).
5. Wyjąć zawias górny (5).

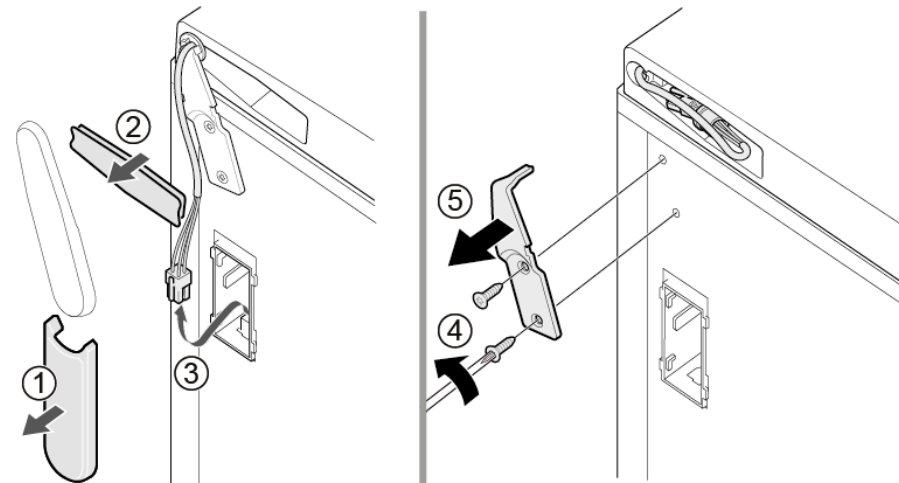

➡ Górny zawias drzwiczek jest zdemontowany.

## 4.5.2 Montaż zawiasu drzwiczek

- ▶ Montaż w odwrotnej kolejności.

## 4.6 Wymiana dolnego zawiasu drzwiczek

### Pomoce specjalne

Torx Bit TX20

6,3 mm (1/4")

[00340865]

	<b>⚠ OSTRZEŻENIE</b>
	<p><b>Ciężkie, nieporęczne urządzenia!</b> Kontuzje mięśni i pleców</p> <ul style="list-style-type: none"> <li>▶ Czynność demontażu drzwiczek urządzenia powinna być wykonywana tylko przez wyszkolonych techników.</li> <li>▶ Przemieszczenie urządzenia wymaga udziału dwóch osób.</li> <li>▶ Używać tylko odpowiednich narzędzi i sprzętu.</li> </ul>

	<b>⚠ WAŻNE</b>
	<p><b>Ostre krawędzie!</b> Rany cięte</p> <ul style="list-style-type: none"> <li>▶ Zawsze używaj rękawic ochronnych.</li> </ul>

	<b>⚠ OSTRZEŻENIE</b>
	<p><b>Możliwość wyslizgnięcia się przechylnego urządzenia!</b> Złamania kości / zmiżdżenia</p> <ul style="list-style-type: none"> <li>▶ Zabezpieczyć urządzenia przed wyslizgnięciem.</li> </ul>

	<b>⚠ WAŻNE</b>
	<p><b>Niebezpieczeństwo spadnięcia części po wykręceniu śrub!</b> Zranienie przez spadające części.</p> <ul style="list-style-type: none"> <li>▶ Zabezpieczyć część przed spadnięciem.</li> </ul>

	<b>UWAGA!</b>
	<p><b>Niebezpieczeństwo spadnięcia części po wykręceniu śrub!</b> Uszkodzenie innych części urządzenia albo pomieszczenia mieszkalnego, np. podłogi.</p> <ul style="list-style-type: none"> <li>▶ Zabezpieczyć część przed spadnięciem.</li> </ul>

### Warunek:

- ✔ Urządzenie jest odłączone od źródła zasilania energią elektryczną.
- ✔ Zostały zdemonstrowane wewnętrzne elementy mocujące urządzenia.
- ✔ Urządzenie jest położone "na plecach".

✔ [Górny zawias jest zdemontowany. → 376](#)

### 4.6.1 Wymiana dolnego zawiasu drzwiczek

1. Wyjąć drzwiczki.

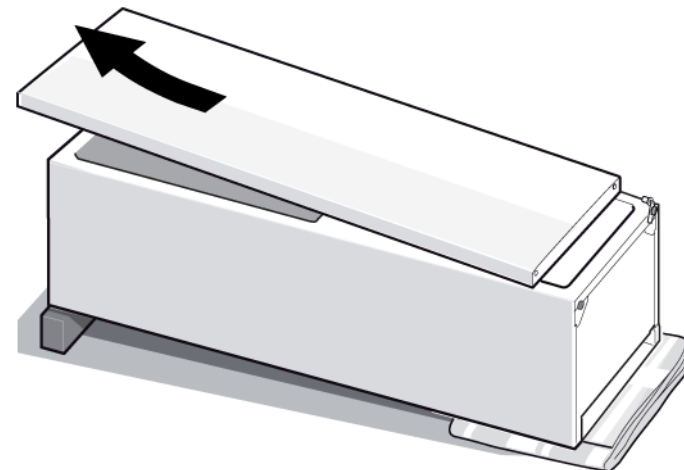

2.
  1. Odkręcić śrubę (1).
  2. Obrócić zawias dolny do zewnątrz (2).
  3. Wyjąć zawias dolny (3).

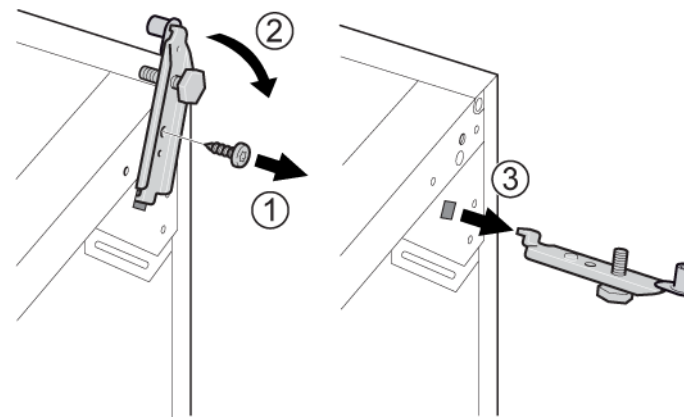

➡ Dolny zawias jest zdemontowany.

### 4.6.2 Montaż dolnego zawiasu drzwiczek

- ▶ Montaż w odwrotnej kolejności.

## 4.7 Wymiana półki

### Warunek:

- ✔ Drzwiczki są otwarte.

### 4.7.1 Demontaż półki

- ▶ Wyciągnąć półkę.

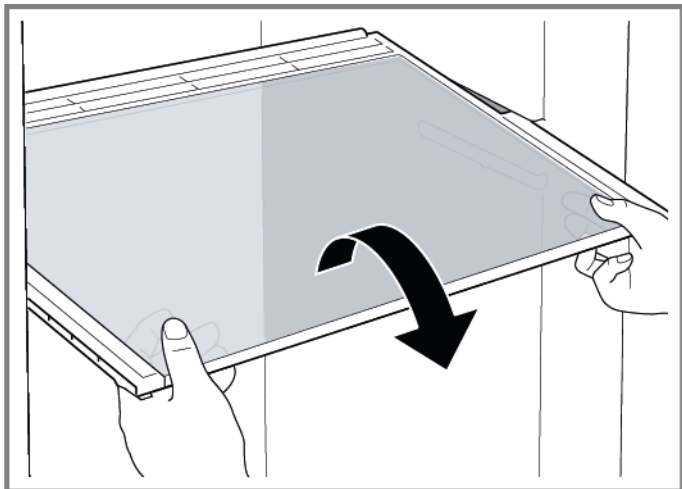

- ➡ Półka jest wyjęta.

### 4.7.2 Montaż półki

- ▶ Montaż w odwrotnej kolejności.

## 4.8 Wymiana pojemnika na mrożoną żywność

### Warunek:

- ✔ Drzwiczki są otwarte.

### 4.8.1 Demontaż pojemnika na mrożoną żywność

- ▶ 1. Wyciągnąć pojemnik na mrożoną żywność do końca (1).
- ▶ 2. Wyjąć pojemnik na mrożoną żywność (2).

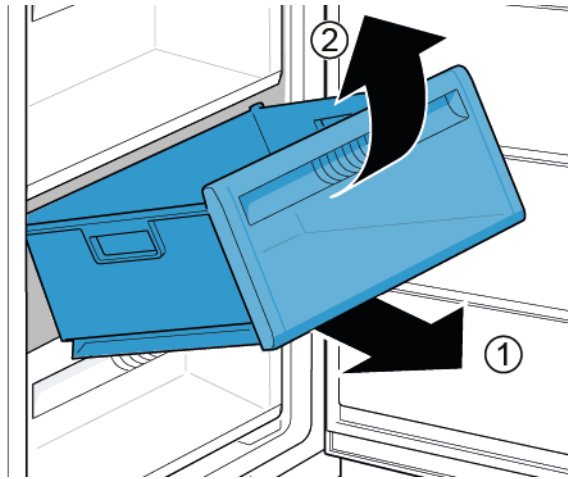

- ➡ Pojemnik na mrożoną żywność został wyjęty.

### 4.8.2 Montaż pojemnika na mrożoną żywność

- ▶ Montaż w odwrotnej kolejności.

## 4.9 Wymiana kostkarki do lodu

### Warunek:

- ✔ Drzwiczki są otwarte.

### 4.9.1 Demontaż kostkarki do lodu

- ▶ 1. Wyciągnąć półkę pojemnika na mrożoną żywność z kostkarką do lodu (1).
- ▶ 2. Zwolnić zaczepy (2).
- ▶ 3. Wyjąć kostkarkę do lodu (3).

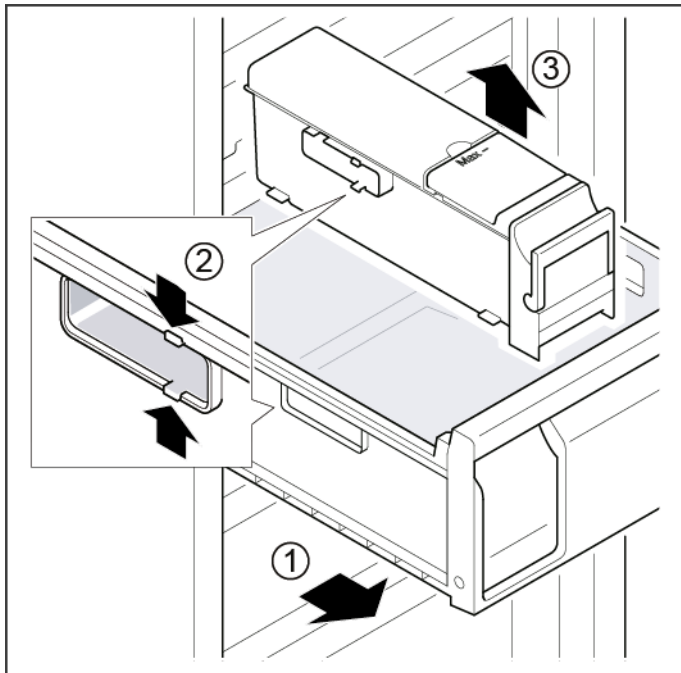

- ➡ Kostkarka do lodu jest wyjęta.

### 4.9.2 Montaż kostkarki do lodu

- ▶ Montaż w odwrotnej kolejności.

## 4.10 Wymiana górnego oświetlenia LED

### Pomoce specjalne

- Śrubokręt z końcówką płaską Końcówka 2,4 mm x 0,4 mm x 60 mm, w zestawie [00341820]

	Urządzenie posiada bezobsługowe oświetlenie LED. Tego rodzaju elementy oświetleniowe mogą być naprawiane wyłącznie przez serwis lub autoryzowanych techników!
---	---

	<p><b>⚠ NIEBEZPIECZEŃSTWO</b></p> <p><b>Ryzyko porażenia prądem elektrycznym wskutek kontaktu z elementami znajdującymi się pod napięciem!</b></p> <p>Niebezpieczeństwo utraty życia wskutek porażenia prądem elektrycznym w przypadku nieprawidłowej naprawy</p> <ul style="list-style-type: none"> <li>▶ Części elektryczne powinny być naprawiane przez wykwalifikowanych elektryków.</li> <li>▶ Po naprawie należy przeprowadzić test bezpieczeństwa zgodny z przepisami normy VDE 0701 (Niemcy) lub odpowiednimi przepisami obowiązującymi w kraju użytkowania.</li> </ul>
--	---

	<p><b>⚠ NIEBEZPIECZEŃSTWO</b></p> <p><b>Ryzyko porażenia prądem, ze względu na elementy będące pod napięciem!</b></p> <p>Zagrożenie życia poprzez porażenie prądem</p> <ul style="list-style-type: none"> <li>▶ Odłączyć urządzenie od zasilania sieciowego na 60 sekund przed rozpoczęciem naprawy.</li> </ul>
--	---

	<p><b>⚠ WAŻNE</b></p> <p><b>Ostre krawędzie!</b></p> <p>Rany cięte</p> <ul style="list-style-type: none"> <li>▶ Zawsze używaj rękawic ochronnych.</li> </ul>
--	--

### Warunek:

- ✔ Urządzenie jest odłączone od źródła zasilania energią elektryczną.
- ✔ Drzwiczki są otwarte.
- ✔ Zostały zdemonstrowane górne wewnętrzne elementy mocujące.

### 4.10.1 Demontaż oświetlenia LED

- Przesunąć oświetlenie LED w lewo.

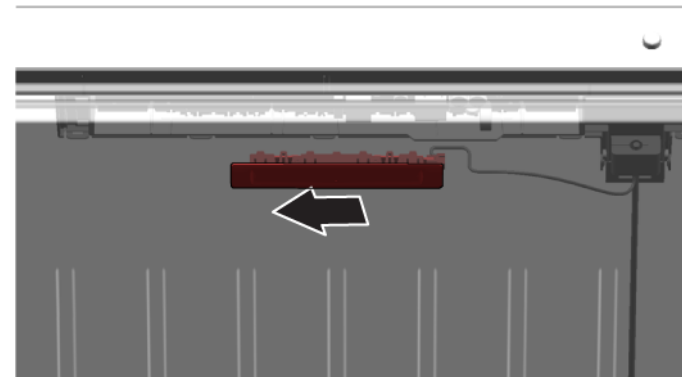

- ➡ Złącze elektryczne oświetlenia LED jest rozłączone.

- Zwolnić zaczepy oświetlenia LED.

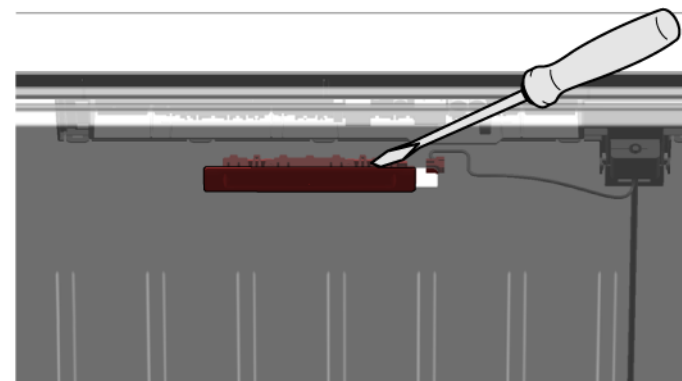



3. Wyjąć oświetlenie LED przez przesunięcie go do przodu.

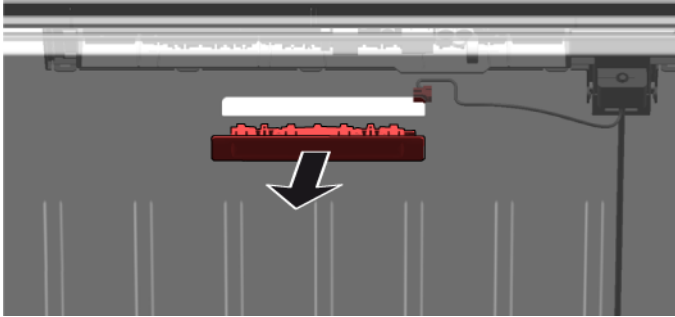

- ➡ Oświetlenie LED zostało wymontowane.

### 4.10.2 Montaż górnego oświetlenia LED

- ▶ Montaż w odwrotnej kolejności.

# Dicas de resolução - Congelador

 <b>Sobre este documento</b> .....	<b>387</b>
1.1 Informação importante .....	387
1.1.1 Finalidade.....	387
1.2 Explicação dos símbolos.....	387
1.2.1 Níveis de perigo.....	387
1.2.2 Símbolos de perigo .....	387
1.2.3 Estrutura dos avisos.....	388
1.2.4 Símbolos gerais .....	388
 <b>Segurança</b> .....	<b>389</b>
2.1 Instruções gerais de segurança.....	389
2.1.1 Todos os eletrodomésticos .....	389
 <b>Ferramentas e auxiliares</b> .....	<b>390</b>
 <b>Reparação</b> .....	<b>391</b>
4.1 Substituir a junta da porta .....	391
4.1.1 Remover a junta da porta .....	391
4.1.2 Instalar a junta da porta.....	391
4.2 Substituir o puxador da porta .....	394
4.2.1 Remover o puxador da porta .....	394
4.2.2 Instalar o puxador da porta .....	394
4.3 Substituir o puxador "easy opening" .....	395
4.3.1 Remover o puxador "easy opening" .....	395
4.3.2 Instalar o puxador "easy opening" .....	395
4.4 Substituir a dobradiça superior da porta.....	396
4.4.1 Remover a dobradiça da porta.....	396
4.4.2 Instalar a dobradiça da porta .....	398
4.5 Substituir a dobradiça superior da porta (porta com visor).....	399
4.5.1 Remover a dobradiça da porta.....	400
4.5.2 Instalar a dobradiça da porta .....	401
4.6 Substituir a dobradiça inferior da porta.....	402
4.6.1 Substituir a dobradiça inferior da porta .....	402
4.6.2 Instalar a dobradiça inferior da porta .....	403
4.7 Substituir a prateleira .....	404
4.7.1 Remover a prateleira.....	404
4.7.2 Instalar a prateleira .....	404

4.8 Substituir o recipiente para alimentos congelados.....	405
4.8.1 Remover o recipiente para alimentos congelados.....	405
4.8.2 Instalar o recipiente para alimentos congelados .....	405
4.9 Substituir a máquina de fazer gelo .....	406
4.9.1 Remover a máquina de fazer gelo .....	406
4.9.2 Instalar a máquina de fazer gelo.....	406
4.10 Substituir a iluminação LED superior.....	407
4.10.1 Remover a iluminação LED.....	407
4.10.2 Instalar a iluminação LED superior .....	408

# **i** Sobre este documento

## 1.1 Informação importante

### 1.1.1 Finalidade

Estas dicas de reparação auxiliam o consumidor na reparação de aparelhos por ele próprio de acordo com o regulamento de "Eco-design" aplicável (a partir de 03/2021).

Estas contêm informações sobre como substituir peças sobressalentes definidas, incluindo avisos e riscos.

Em caso de dúvidas, entre em contacto com o nosso serviço de apoio ao cliente. Apenas nos responsabilizaremos por danos se as dicas de reparação tiverem sido devidamente seguidas.

## 1.2 Explicação dos símbolos

### 1.2.1 Níveis de perigo

Os níveis de aviso são compostos por um símbolo e uma palavra sinal. A palavra-sinal indica a gravidade do perigo.









Nível de aviso	Significado
 <b>PERIGO</b>	A não observância da mensagem de aviso resulta em morte ou ferimentos graves.
 <b>AVISO</b>	A não observância da mensagem de aviso pode resultar em morte ou ferimentos graves.
 <b>CUIDADO</b>	A não observância da mensagem de aviso pode resultar em ferimentos ligeiros.
 <b>ATENÇÃO!</b>	A não observância da mensagem de aviso pode resultar em danos materiais.

Tabela 1: Níveis de perigo

### 1.2.2 Símbolos de perigo

Os símbolos de perigo são representações simbólicas que dão uma indicação do tipo de perigo.

Neste documento são utilizados os seguintes símbolos de perigo:

Símbolo de perigo	Significado
	Mensagem geral de aviso
	Perigo de tensão elétrica
	Risco de explosão
	Perigo de cortes

## **i** Sobre este documento





Símbolo de perigo	Significado
	Perigo de esmagamento
	Perigo de superfícies quentes
	Perigo de campo eletromagnético intenso
	Perigo de radiação não-ionizante

Tabela 2: Símbolos de perigo

### 1.2.3 Estrutura dos avisos

Os avisos neste documento possuem um aspeto normalizado e uma estrutura normalizada.

	<b>⚠ PERIGO</b>
<b>Tipo e origem do perigo!</b>	
Possíveis consequência de ignorar o perigo / aviso.	
▶ Medidas e proibições para prevenir o perigo.	

O seguinte exemplo mostra um aviso que adverte contra choques elétricos devido a partes sob tensão. A medida para evitar o perigo é mencionada.

	<b>⚠ PERIGO</b>
<b>Risco de choque elétrico devido a partes sob tensão!</b>	
Morte por eletrocussão	
▶ Desligue os aparelhos da alimentação elétrica pelo menos 60 segundos antes de iniciar as reparações.	

### 1.2.4 Símbolos gerais

Neste documento são utilizados os seguintes símbolos gerais:







Símbolo ger.	Significado
	Identificação de uma dica especial (texto e/ou ilustração)
	Identificação de uma dica simples (apenas texto)
	Identificação de uma ligação para um tutorial em vídeo
	Identificação das ferramentas necessárias
	Identificação das condições prévias necessárias
	Identificação de uma condição (se ..., então ...)
	Identificação de um resultado
Iniciar	Identificação de uma tecla ou botão
[00123456]	Identificação de um número de material
Estado	Identificação de um texto exibido / janela (no visor do aparelho)

Tabela 3: Símbolos gerais

## 2.1 Instruções gerais de segurança

### 2.1.1 Todos os eletrodomésticos

#### **Risco de choque elétrico devido a partes sob tensão!**

- Erros por reparações envolvendo componentes elétricos podem provocar choques elétricos!
- Desligue o aparelho da rede elétrica pelo menos 60 segundos antes de iniciar o trabalho.
- Após a reparação, solicite a realização de um teste de segurança de acordo com VDE 0701 ou os regulamentos específicos do país.

#### **Risco de ferimentos causados por arestas vivas!**

- Use luvas de proteção.

#### **Risco de esmagamento durante trabalhos de reparação, manutenção, resolução de problemas e serviço devido a componentes pesados e móveis**

- Use calçado de proteção.
- Proteja os componentes pesados contra quedas.
- Não introduzir partes do corpo em componentes móveis.



#### **Risco para a segurança/funcionamento do aparelho!**

- Utilize apenas peças sobressalentes originais.

#### **Risco de danos em componentes electrostaticamente sensíveis (ESDs)!**

- Não toque nos módulos, incluindo ligações e percursos condutores.

## Ferramentas e auxiliares

Designação	Detalhes	Imagens
Pano protetor [00342013]	60 cm x 50 cm	
Chave de parafusos Phillips PH2		
Ponta Torx TX20 [00340865]	6,3 mm (1/4")	
Chave de fendas	Lâmina 2,4 mm x 0,4 mm x 60 mm, no kit [00341820]	

## 4.1 Substituir a junta da porta

### Pré-requisito:

- ✔ A porta está aberta.

### 4.1.1 Remover a junta da porta

1. Solte a junta da porta da ranhura nos cantos direito e esquerdo.



2. Puxe a junta da porta para fora da ranhura.



- ➡ A junta da porta está removida.

### 4.1.2 Instalar a junta da porta

	A espessura da nova junta da porta pode divergir ligeiramente da da junta antiga da porta. Isto não afetará o comportamento de fecho nem o funcionamento a longo termo.
	Se o seu aparelho dispor de dobradiças ou fixações de dobradiça ajustáveis, poderá otimizar o comportamento de fecho subsequentemente.
	Os pequenos orifícios laterais na junta da porta são funcionais (necessários à ventilação). Não se trata de falhas de produção.

## Reparação

1. Verifique se a ranhura para a junta apresenta danos.

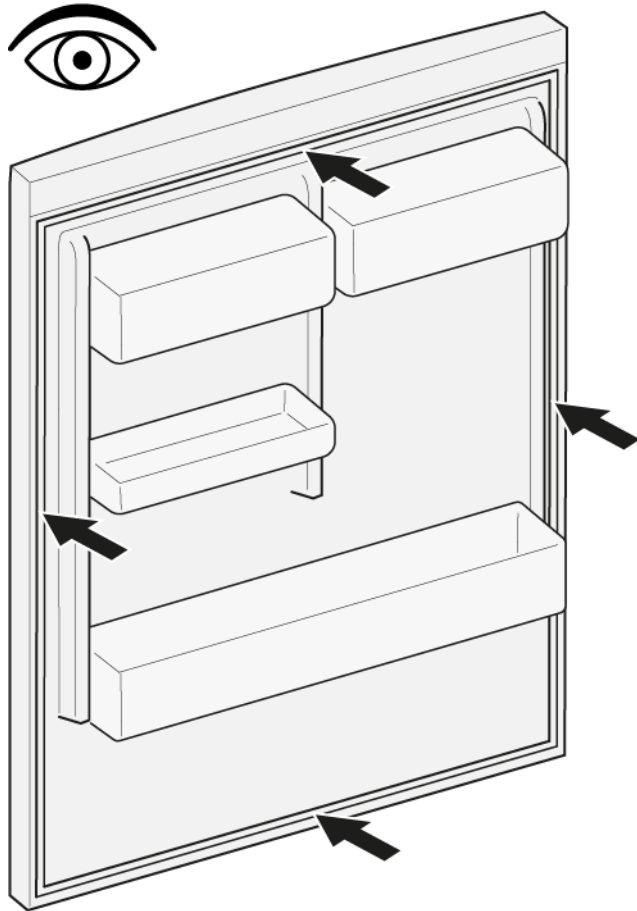

2.  Se a ranhura para a junta estiver danificada,  
- contacte o serviço de apoio ao consumidor.

3.  Uma deformação ligeira da junta da porta é normal e não afeta o seu funcionamento. Recomenda-se que a junta da porta seja endireitada antes de ser inserida no aparelho.

Aqueça a junta da porta com a um secador de cabelo ou água quente e mude a sua forma manualmente.

4. Empurre os cantos da junta em cima e em baixo para ranhura.

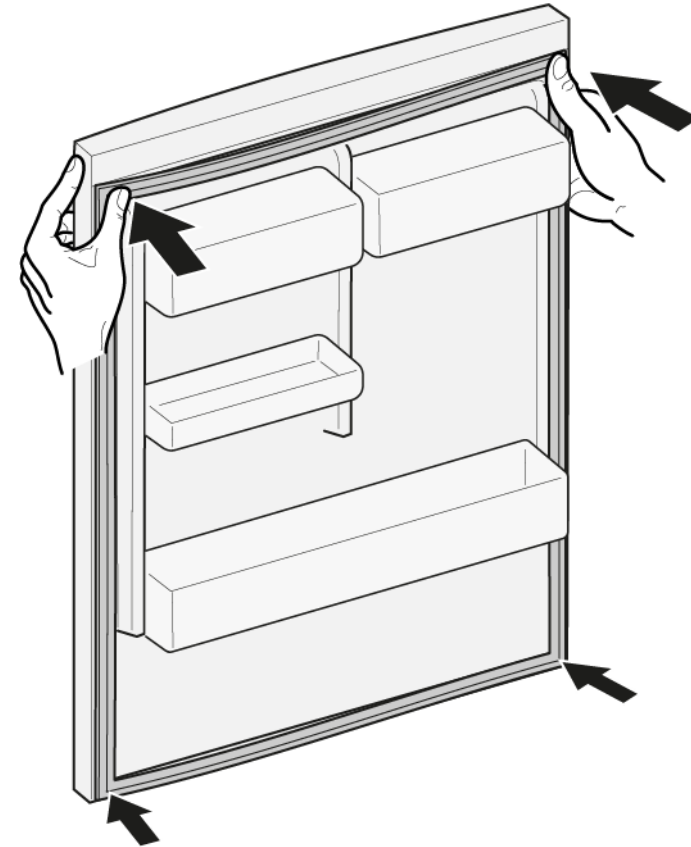



## Reparação



5. Pressione a junta inteira gradualmente para dentro da ranhura.





-  A junta da porta está instalada.

## 4.2 Substituir o puxador da porta

### Ferramentas necessárias:

-  Ponta Torx TX20                      6,3 mm (1/4")                      [00340865]
-  Chave de fendas                      Lâmina 10 mm x 1,6 mm x 200 mm

### Pré-requisito:

-  O aparelho está desligado da alimentação elétrica.
-  A porta está aberta.

### 4.2.1 Remover o puxador da porta

- ▶ 1. Remova duas tampas roscadas (1).
- ▶ 2. Desaperte dois parafusos (2).
- ▶ 3. Remova o puxador da porta (3).

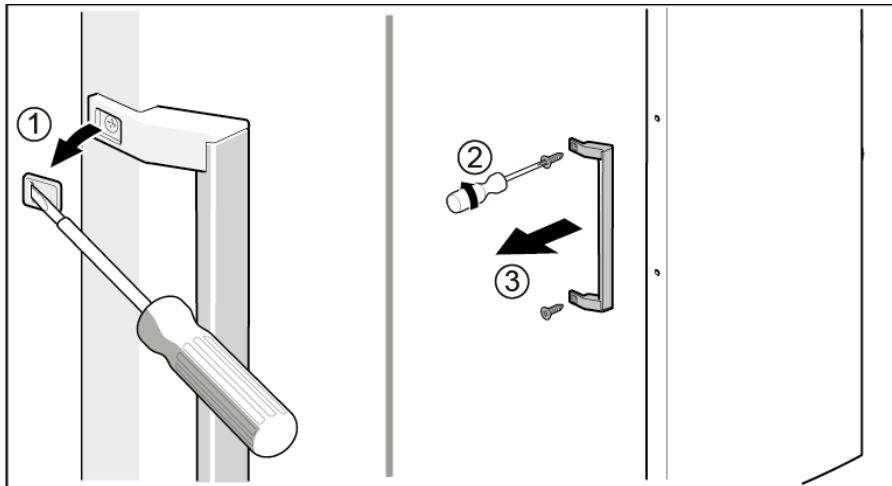

-  O puxador da porta está removido.

### 4.2.2 Instalar o puxador da porta

- ▶ Instale pela ordem inversa.

## 4.3 Substituir o puxador "easy opening"

### Ferramentas necessárias:

- 🔩 Chave de parafusos Phillips PH2

### Pré-requisito:

- ✔ O aparelho está desligado da alimentação elétrica.
- ✔ A porta está aberta.

### 4.3.1 Remover o puxador "easy opening"

- ▶ 1. Remova a tampa do puxador "easy opening" (1).
- ▶ 2. Desaperte dois parafusos (2).

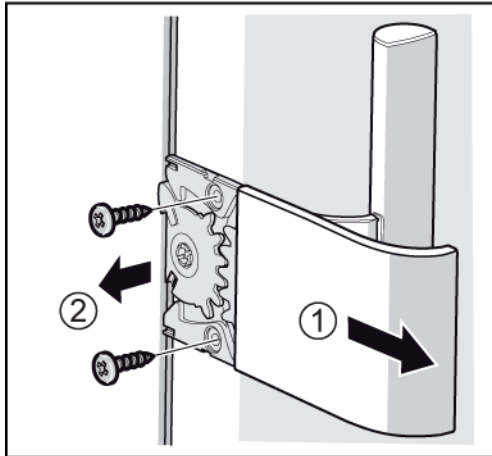

- ➡ O puxador "easy opening" está removido.

### 4.3.2 Instalar o puxador "easy opening"

O mecanismo do puxador "easy opening" deve ser ajustado adequadamente antes da instalação.

O gráfico mostra a disposição correta da haste de toque (1), dos segmentos dentados (2) e (3), da mola (4) e do batente limitador (5) para a instalação da porta do lado esquerdo.

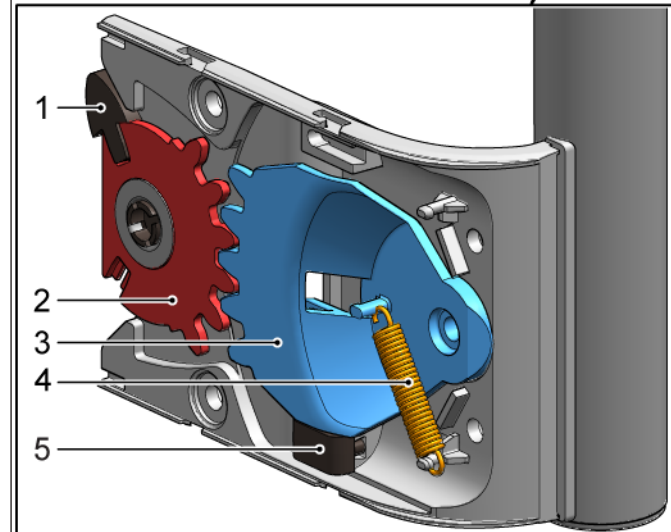
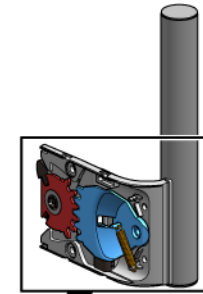



A disposição dos sub componentes do puxador "easy opening" para a instalação da porta do lado direito vem descrita no documento "Instruções de instalação".



- ▶ Instale pela ordem inversa.



## 4.4 Substituir a dobradiça superior da porta



### Ferramentas necessárias:

 Ponta Torx TX20      6,3 mm (1/4")      [00340865]

	 <b>AVISO</b>
	<p><b>Aparelhos pesados e volumosos!</b> Lesões nas costas e musculares</p> <ul style="list-style-type: none"><li>▶ A operação de remoção da porta do aparelho deve ser apenas executada por especialistas formados.</li><li>▶ São necessárias duas pessoas para mover o aparelho.</li><li>▶ Use apenas ferramentas e equipamento adequados.</li></ul>



	 <b>CUIDADO</b>
	<p><b>Arestas vivas!</b> Lesões por corte</p> <ul style="list-style-type: none"><li>▶ Use luvas de proteção.</li></ul>

	 <b>AVISO</b>
	<p><b>Deslizamento de aparelhos inclinados!</b> Fraturas ósseas / ferimentos de esmagamento</p> <ul style="list-style-type: none"><li>▶ Proteja os aparelhos contra o deslizamento.</li></ul>

	 <b>CUIDADO</b>
	<p><b>Risco de queda de peças devido a parafusos desapertados!</b> Lesões devido à queda de peças.</p> <ul style="list-style-type: none"><li>▶ Proteja o componente contra as quedas.</li></ul>

	<b>ATENÇÃO!</b>
	<p><b>Risco de queda de peças devido a parafusos desapertados!</b> Danos em outros componentes do aparelho ou na casa do cliente, p. ex., no pavimento.</p> <ul style="list-style-type: none"><li>▶ Proteja o componente contra as quedas.</li></ul>

### Pré-requisito:

-  O aparelho está desligado da alimentação elétrica.
-  As fixações interiores do aparelho estão removidas.

## 4.4.1 Remover a dobradiça da porta

## Reparação

1. Coloque o aparelho sobre o lado traseiro.

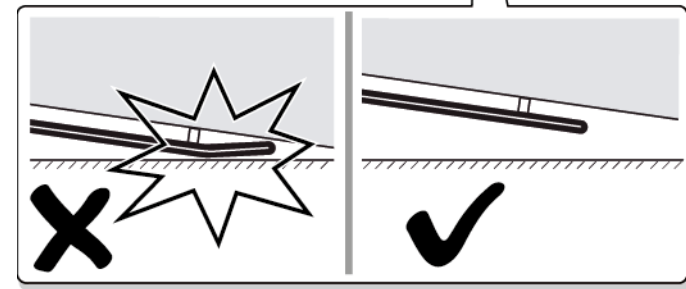
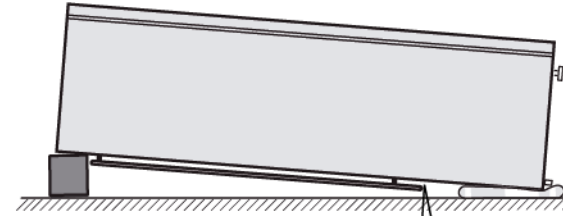
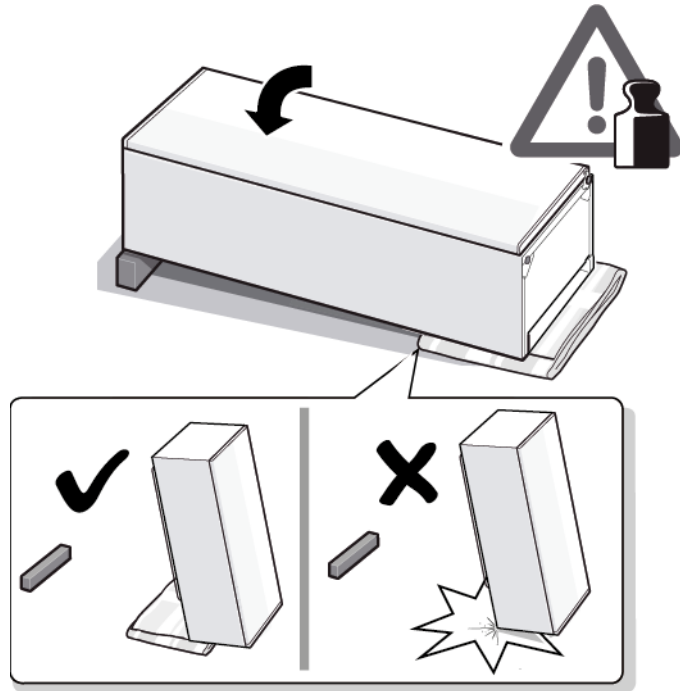

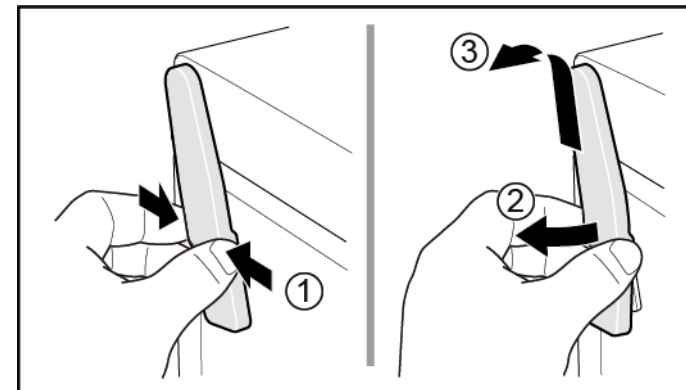

2. 1. Pressione a tampa da dobradiça superior de ambos os lados (1).
2. Extraia a tampa da dobradiça superior (2).
3. Remova a tampa da dobradiça superior (3).

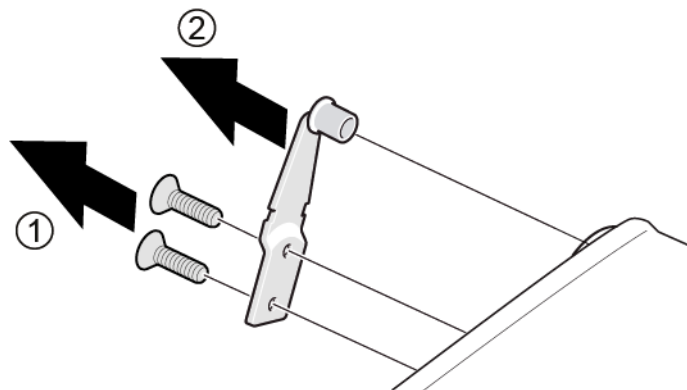

## Reparação

3. 1. Desaperte dois parafusos (1).
2. Remova a dobradiça superior (2).



 A dobradiça superior da porta está removida.

### 4.4.2 Instalar a dobradiça da porta

- ▶ Instale pela ordem inversa.

## 4.5 Substituir a dobradiça superior da porta (porta com visor)

### Ferramentas necessárias:

 Ponta Torx TX20      6,3 mm (1/4")      [00340865]

	<b>⚠ AVISO</b>
	<b>Aparelhos pesados e volumosos!</b> Lesões nas costas e musculares <ul style="list-style-type: none"><li>▶ A operação de remoção da porta do aparelho deve ser apenas executada por especialistas formados.</li><li>▶ São necessárias duas pessoas para mover o aparelho.</li><li>▶ Use apenas ferramentas e equipamento adequados.</li></ul>

	<b>⚠ CUIDADO</b>
	<b>Arestas vivas!</b> Lesões por corte <ul style="list-style-type: none"><li>▶ Use luvas de proteção.</li></ul>

	<b>⚠ AVISO</b>
	<b>Deslizamento de aparelhos inclinados!</b> Fraturas ósseas / ferimentos de esmagamento <ul style="list-style-type: none"><li>▶ Proteja os aparelhos contra o deslizamento.</li></ul>

	<b>⚠ CUIDADO</b>
	<b>Risco de queda de peças devido a parafusos desapertados!</b> Lesões devido à queda de peças. <ul style="list-style-type: none"><li>▶ Proteja o componente contra as quedas.</li></ul>

	<b>ATENÇÃO!</b>
	<b>Risco de queda de peças devido a parafusos desapertados!</b> Danos em outros componentes do aparelho ou na casa do cliente, p. ex., no pavimento. <ul style="list-style-type: none"><li>▶ Proteja o componente contra as quedas.</li></ul>

	<b>⚠ PERIGO</b>
	<b>Risco de choque elétrico devido a partes sob tensão!</b> Risco de vida devido a choque elétrico em caso de reparação inadequada <ul style="list-style-type: none"><li>▶ As partes elétricas devem ser reparadas por um electricista qualificado.</li><li>▶ Após a reparação, solicite a realização de um teste de segurança de acordo com VDE 0701 ou os regulamentos específicos do país.</li></ul>

	<b>⚠ PERIGO</b>
	<b>Risco de choque elétrico devido a partes sob tensão!</b> Morte por eletrocussão <ul style="list-style-type: none"><li>▶ Desligue os aparelhos da alimentação elétrica pelo menos 60 segundos antes de iniciar as reparações.</li></ul>

### Pré-requisito:

- ✔ O aparelho está desligado da alimentação elétrica.
- ✔ As fixações interiores do aparelho estão removidas.

### 4.5.1 Remover a dobradiça da porta

1. Coloque o aparelho sobre o lado traseiro.

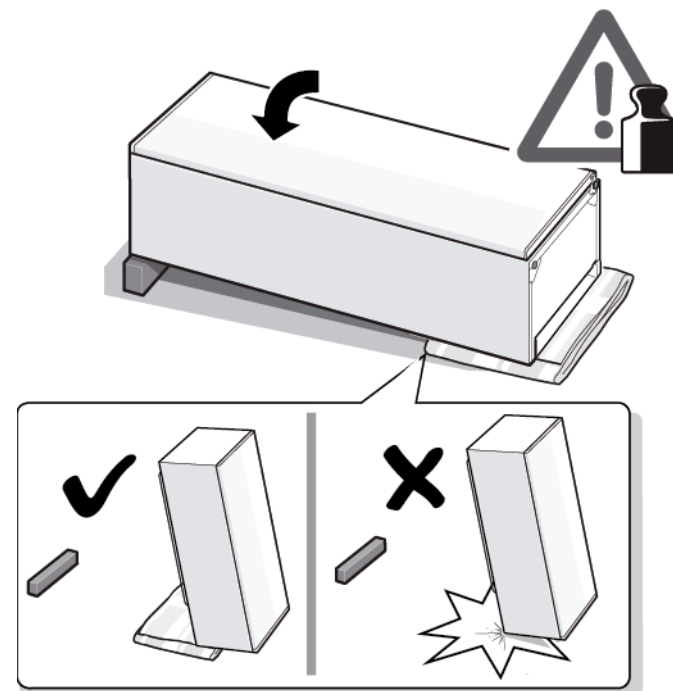



## Reparação

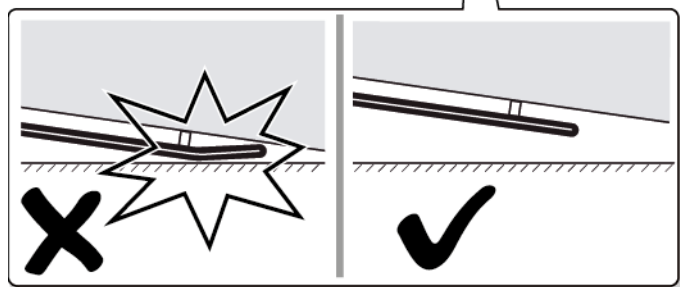
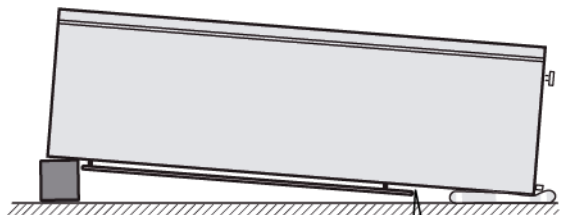

1. Pressione a tampa da dobradiça superior de ambos os lados (1).
2. Extraia a tampa da dobradiça superior (2).
3. Remova a tampa da dobradiça superior (3).

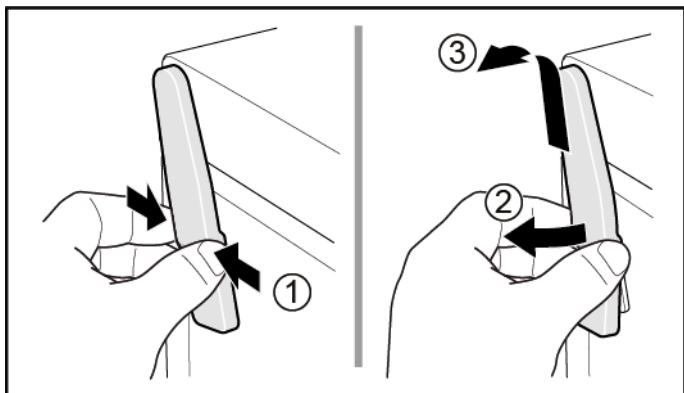

1. Remova a tampa da caixa de cabos (1).
2. Remova a proteção dos cabos (2).
3. Desconecte a ligação elétrica (3).
4. Desaperte dois parafusos (4).
5. Remova a dobradiça superior (5).

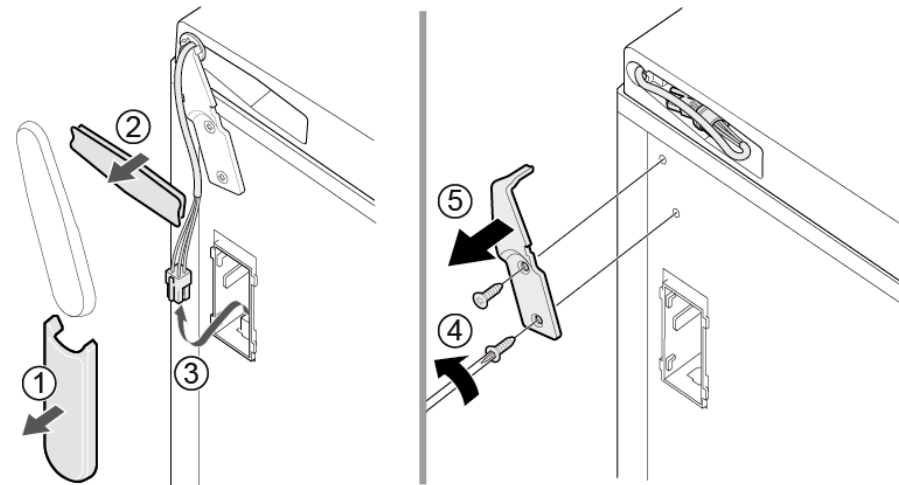

➡ A dobradiça superior da porta está removida.

### 4.5.2 Instalar a dobradiça da porta

- ▶ Instale pela ordem inversa.

## 4.6 Substituir a dobradiça inferior da porta

### Ferramentas necessárias:

🔧 Ponta Torx TX20      6,3 mm (1/4")      [00340865]

	<b>⚠️ AVISO</b>
<b>Aparelhos pesados e volumosos!</b>	
Lesões nas costas e musculares	
<ul style="list-style-type: none"> <li>▶ A operação de remoção da porta do aparelho deve ser apenas executada por especialistas formados.</li> <li>▶ São necessárias duas pessoas para mover o aparelho.</li> <li>▶ Use apenas ferramentas e equipamento adequados.</li> </ul>	

	<b>⚠️ CUIDADO</b>
<b>Arestas vivas!</b>	
Lesões por corte	
<ul style="list-style-type: none"> <li>▶ Use luvas de proteção.</li> </ul>	

	<b>⚠️ AVISO</b>
<b>Deslizamento de aparelhos inclinados!</b>	
Fraturas ósseas / ferimentos de esmagamento	
<ul style="list-style-type: none"> <li>▶ Proteja os aparelhos contra o deslizamento.</li> </ul>	

	<b>⚠️ CUIDADO</b>
<b>Risco de queda de peças devido a parafusos desapertados!</b>	
Lesões devido à queda de peças.	
<ul style="list-style-type: none"> <li>▶ Proteja o componente contra as quedas.</li> </ul>	

	<b>⚠️ ATENÇÃO!</b>
<b>Risco de queda de peças devido a parafusos desapertados!</b>	
Danos em outros componentes do aparelho ou na casa do cliente, p. ex., no pavimento.	
<ul style="list-style-type: none"> <li>▶ Proteja o componente contra as quedas.</li> </ul>	

### Pré-requisito:

- ✔️ O aparelho está desligado da alimentação elétrica.
- ✔️ As fixações interiores do aparelho estão removidas.
- ✔️ O aparelho é colocado sobre o lado traseiro.

✔️ [A dobradiça superior está removida. → 399](#)

### 4.6.1 Substituir a dobradiça inferior da porta

1. Remova a porta.

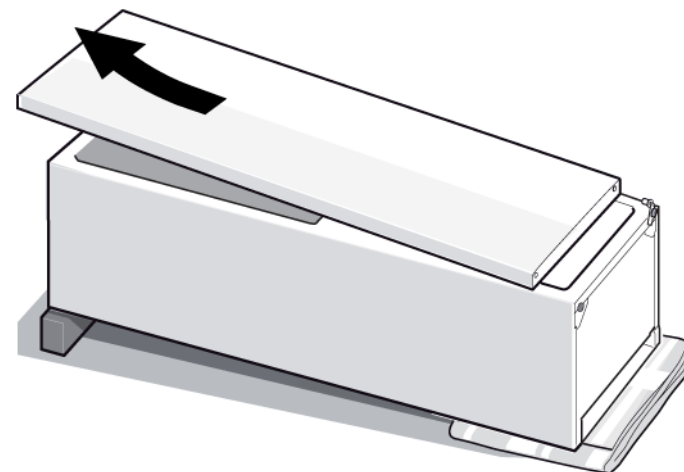

2.
  1. Desaperte o parafuso (1).
  2. Vire a dobradiça inferior para fora (2).
  3. Remova a dobradiça inferior (3).

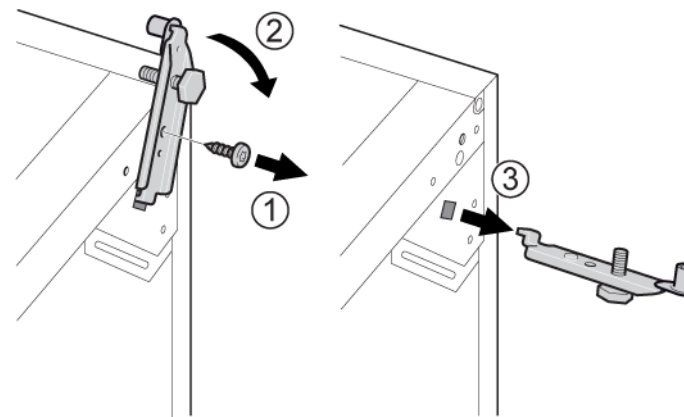

➡ A dobradiça inferior está removida.

### **4.6.2 Instalar a dobradiça inferior da porta**

- ▶ Instale pela ordem inversa.

## 4.7 Substituir a prateleira

Pré-requisito:

- ✔ A porta está aberta.

### 4.7.1 Remover a prateleira

- ▶ Puxe a prateleira para fora.



➡ A prateleira está removida.

### 4.7.2 Instalar a prateleira

- ▶ Instale pela ordem inversa.

## 4.8 Substituir o recipiente para alimentos congelados

### Pré-requisito:

- ✔ A porta está aberta.

### 4.8.1 Remover o recipiente para alimentos congelados

- ▶ 1. Puxe o recipiente para alimentos congelados inteiramente para fora (1).
- ▶ 2. Remova o recipiente para alimentos congelados (2).

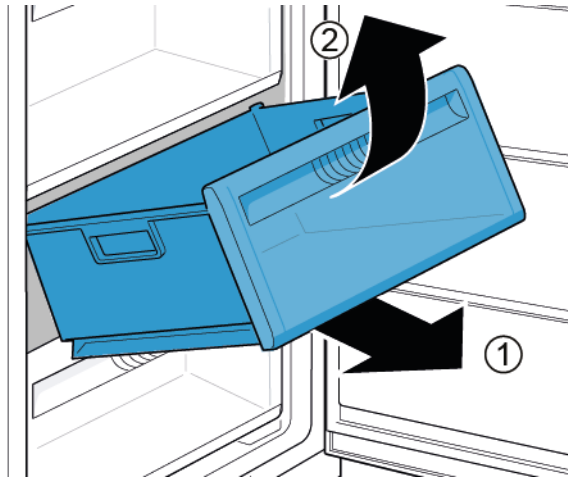

- ➡ O recipiente para alimentos congelados está removido.

### 4.8.2 Instalar o recipiente para alimentos congelados

- ▶ Instale pela ordem inversa.

## 4.9 Substituir a máquina de fazer gelo

### Pré-requisito:

- ✔ A porta está aberta.

### 4.9.1 Remover a máquina de fazer gelo

- ▶ 1. Puxe para fora a prateleira do recipiente para alimentos congelados com máquina de fazer gelo (1).
- ▶ 2. Solte os ganchos (2).
- ▶ 3. Remova a máquina de fazer gelo (3).

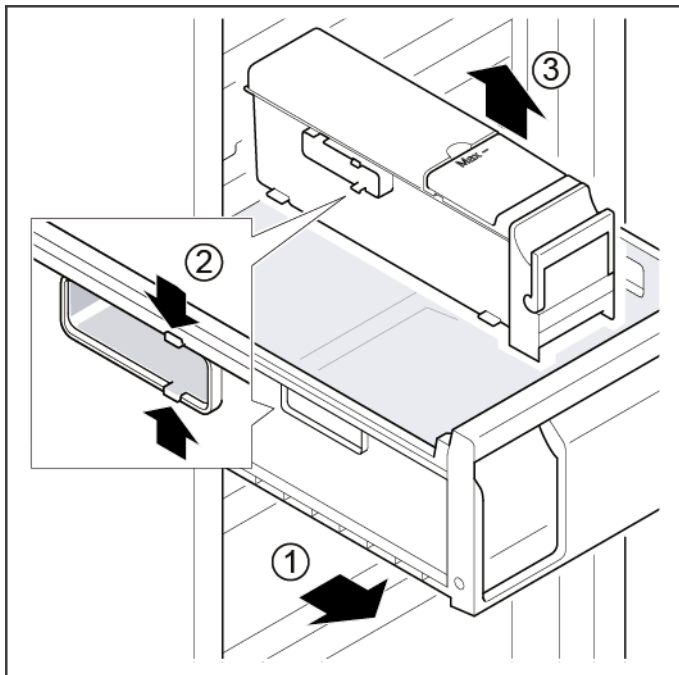

➡ A máquina de fazer gelo está removida.

### 4.9.2 Instalar a máquina de fazer gelo

- ▶ Instale pela ordem inversa.

## 4.10 Substituir a iluminação LED superior

### Ferramentas necessárias:

-  Chave de fendas      Lâmina 2,4 mm x 0,4 mm x 60 mm,  
no kit [00341820]



O seu aparelho dispõe de uma iluminação LED isenta de manutenção. Estas iluminações só podem ser reparadas pelo serviço de apoio ao consumidor ou por técnicos autorizados!



### PERIGO

#### Risco de choque elétrico devido a partes sob tensão!

Risco de vida devido a choque elétrico em caso de reparação inadequada

- ▶ As partes elétricas devem ser reparadas por um electricista qualificado.
- ▶ Após a reparação, solicite a realização de um teste de segurança de acordo com VDE 0701 ou os regulamentos específicos do país.



### PERIGO

#### Risco de choque elétrico devido a partes sob tensão!

Morte por eletrocussão

- ▶ Desligue os aparelhos da alimentação elétrica pelo menos 60 segundos antes de iniciar as reparações.





### CUIDADO

#### Arestas vivas!

Lesões por corte

- ▶ Use luvas de proteção.

### Pré-requisito:

-  O aparelho está desligado da alimentação elétrica.
-  A porta está aberta.
-  As fixações interiores superiores estão removidas.

## 4.10.1 Remover a iluminação LED

1. Desloque a iluminação LED para o lado esquerdo.

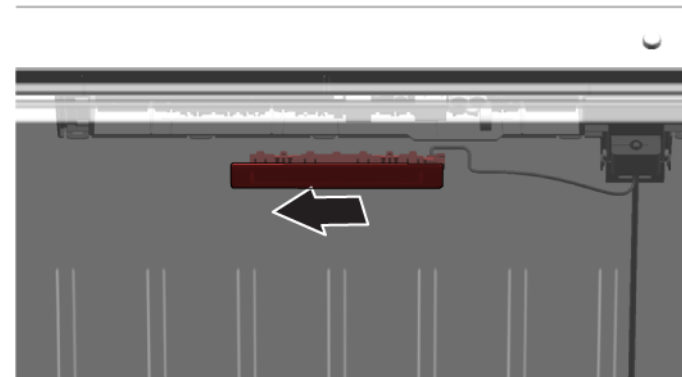

-  A ligação elétrica da iluminação LED está desligada.

2. Solte os ganchos da iluminação LED.

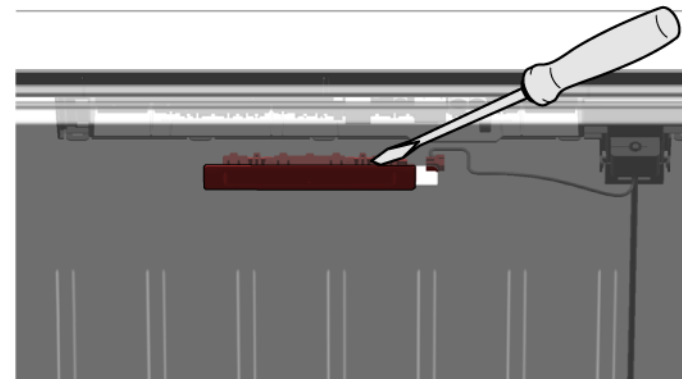

## Reparação

3. Remova a iluminação LED, avançando-a.

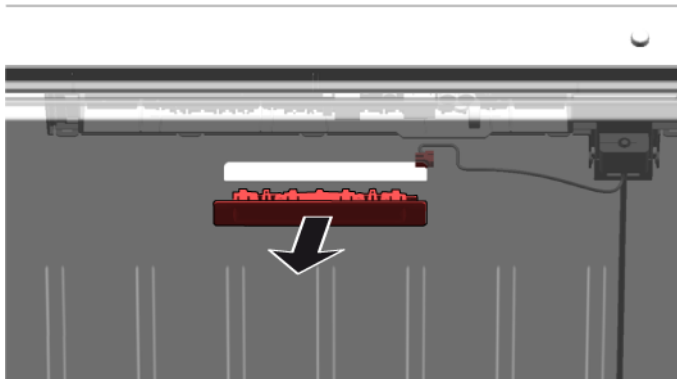

-  A iluminação LED está removida.

### 4.10.2 Instalar a iluminação LED superior

- ▶ Instale pela ordem inversa.



# Indicii pentru reparații - Congelator

 <b>Referitor la acest document</b> .....	<b>410</b>
1.1 Informații importante .....	410
1.1.1 Aplicabilitatea .....	410
1.2 Explicația simbolurilor .....	410
1.2.1 Nivelurile de pericol.....	410
1.2.2 Simbolurile de pericol.....	410
1.2.3 Structura avertismentelor.....	411
1.2.4 Simbolurile generale .....	411
 <b>Siguranța</b> .....	<b>412</b>
2.1 Instrucțiuni generale de siguranță .....	412
2.1.1 Toate aparatele electrocasnice .....	412
 <b>Instrumente și materiale utile</b> .....	<b>413</b>
 <b>Repararea</b> .....	<b>414</b>
4.1 Înlocuirea garniturii ușii .....	414
4.1.1 Demontarea garniturii ușii.....	414
4.1.2 Montarea garniturii ușii .....	414
4.2 Înlocuirea mânerului ușii .....	417
4.2.1 Demontarea mânerului ușii .....	417
4.2.2 Montarea mânerului ușii .....	417
4.3 Înlocuirea easy opening handle .....	418
4.3.1 Demontarea easy opening handle.....	418
4.3.2 Montarea easy opening handle .....	418
4.4 Înlocuirea balamalei de sus a ușii .....	419
4.4.1 Demontarea balamalei ușii .....	419
4.4.2 Montarea balamalei ușii.....	421
4.5 Înlocuirea balamalei de sus a ușii (ușă cu afișaj) .....	422
4.5.1 Demontarea balamalei ușii .....	423
4.5.2 Montarea balamalei ușii.....	424
4.6 Înlocuirea balamalei de jos a ușii .....	425
4.6.1 Înlocuirea balamalei de jos a ușii.....	425
4.6.2 Montarea balamalei de jos a ușii.....	426
4.7 Repoziționarea raftului .....	427
4.7.1 Demontarea raftului.....	427
4.7.2 Montarea raftului .....	427

4.8 Repoziționarea containerului pentru alimente înghețate.....	428
4.8.1 Demontarea containerului pentru alimente înghețate .....	428
4.8.2 Montarea containerului pentru alimente înghețate .....	428
4.9 Repoziționarea recipientului pentru cuburi de gheață .....	429
4.9.1 Demontarea recipientului pentru cuburi de gheață .....	429
4.9.2 Montarea recipientului pentru cuburi de gheață .....	429
4.10 Înlocuirea lămpii LED de sus.....	430
4.10.1 Demontarea lămpii LED .....	430
4.10.2 Montarea lămpii LED de sus .....	431

# **i** Referitor la acest document

## 1.1 Informații importante

### 1.1.1 Aplicabilitatea

Aceste instrucțiuni de reparare îl ajută pe client să își repare singur aparatele, în conformitate cu normele de proiectare ecologică aplicabile (începând cu 03/2021).



Acestea conțin informații privind modul de înlocuire a pieselor de schimb specifice, inclusiv avertismente și pericole.

Dacă aveți întrebări, vă rugăm să luați legătura cu serviciul relații clienți. Ne asumăm răspunderea pentru daune numai dacă instrucțiunile de reparare au fost respectate pe deplin.

## 1.2 Explicația simbolurilor

### 1.2.1 Nivelurile de pericol

Nivelurile de alertă sunt reprezentate printr-un simbol și un cuvânt de avertizare. Cuvântul de avertizare indică gravitatea pericolului.





Nivelul de alertă	Semnificație
 <b>PERICOL</b>	Nerespectarea mesajului de avertizare va provoca accidente grave sau decesul.
 <b>AVERTISMENT</b>	Nerespectarea mesajului de avertizare ar putea provoca accidente grave sau decesul.
 <b>ATENȚIONARE</b>	Nerespectarea mesajului de avertizare ar putea provoca accidente ușoare.
<b>ATENȚIE!</b>	Nerespectarea mesajului de avertizare ar putea provoca daune asupra proprietății.

Tabel 1: Nivelurile de pericol



### 1.2.2 Simbolurile de pericol

Simbolurile de pericol sunt reprezentări simbolice care indică tipul de pericol.

În acest document sunt utilizate simbolurile de pericol de mai jos:

Simbol de pericol	Semnificație
	Mesaj de avertizare general
	Pericol din cauza tensiunii electrice
	Pericol de explozie
	Pericol de tăiere
	Pericol de zdrobire



## Referitor la acest document

Simbol de pericol	Semnificație
	Pericol din cauza suprafețelor fierbinți
	Pericol din cauza câmpului magnetic puternic
	Pericol din cauza radiației neionizante

Tabel 2: Simbolurile de pericol

### 1.2.3 Structura avertismentelor

Avertismentele din acest document au un aspect și o structură standard.



	<div style="background-color: red; color: white; padding: 2px; text-align: center;"> <b>PERICOL</b></div> <p><b>Tipul și sursa pericolului!</b> Consecințele posibile ale ignorării pericolului/avertismentului.</p> <ul style="list-style-type: none"> <li>▶ Măsuri și interdicții pentru prevenirea pericolului.</li> </ul>
--	--





Exemplul următor prezintă un avertisment privind electrocutarea din cauza pieselor sub tensiune. Se menționează măsura necesară pentru a evita pericolul.

	<div style="background-color: red; color: white; padding: 2px; text-align: center;"> <b>PERICOL</b></div> <p><b>Pericol de electrocutare din cauza pieselor sub tensiune!</b> Deces prin electrocutare</p> <ul style="list-style-type: none"> <li>▶ Deconectați aparatele de la sursa de alimentare cu tensiune cu cel puțin 60 de secunde înainte de a începe reparațiile.</li> </ul>
---	---

### 1.2.4 Simbolurile generale

În acest document sunt utilizate simbolurile generale de mai jos:

Simbol general	Semnificație
	Identificarea unei recomandări speciale (text și/sau grafică)
	Identificarea unei recomandări simple (numai text)

Simbol general	Semnificație
	Identificarea unui link spre un videoclip instructiv
	Identificarea sculelor necesare
	Identificarea condițiilor preliminare necesare
	Identificarea unei stări (dacă..., apoi...)
	Identificarea unui rezultat
[Pornire]	Identificarea unei taste sau a unui buton
[00123456]	Identificarea unui număr de serie
Stare	Identificarea unui text/unei ferestre afișate (pe ecranul aparatului)

Tabel 3: Simbolurile generale

## 2.1 Instrucțiuni generale de siguranță

### 2.1.1 Toate aparatele electrocasnice

#### **Pericol de electrocutare din cauza pieselor sub tensiune!**

- Erorile care au loc în timpul reparațiilor efectuate la componentele electrice pot să ducă la electrocutări!
- Deconectați aparatul de la sursa de alimentare cu tensiune cu cel puțin 60 de secunde înainte de a începe lucrările.
- După reparație, este obligatorie efectuarea unei verificări de siguranță conform cu VDE 0701 sau cu reglementările naționale respective.

#### **Pericol de rănire din cauza muchiilor ascuțite!**

- Purtați mănuși de protecție.

#### **Pericol de zdrobire în timpul lucrărilor de reparație, întreținere, depanare și service, din cauza componentelor grele și mobile**

- Purtați încălțăminte de protecție.
- Fixați componentele grele împotriva căderii.
- Nu vă sprijiniți cu părți ale corpului de componentele mobile.



#### **Pericol pentru siguranța/funcționarea aparatului!**

- Utilizați numai piese de schimb originale.

#### **Pericol de deteriorare a componentelor sensibile la electricitatea statică (ESD)!**

- Nu atingeți modulele, inclusiv conexiunile și căile conductorilor.

## Instrumente și materiale utile

Desemnare	Detalii	Imagini
Material textil de protecție [00342013]	60 cm x 50 cm	
Șurubelniță Phillips PH2		
Cap torx TX20 [00340865]	6,3 mm (1/4")	
Șurubelniță plată	Lamă de 2,4 mm x 0,4 mm x 60 mm, în kitul [00341820]	

## 4.1 Înlocuirea garniturii ușii

### Cerință:

- ✓ Ușa este deschisă.

### 4.1.1 Demontarea garniturii ușii

1. Îndepărtați garnitura ușii din canelura colțurilor din dreapta și stânga.



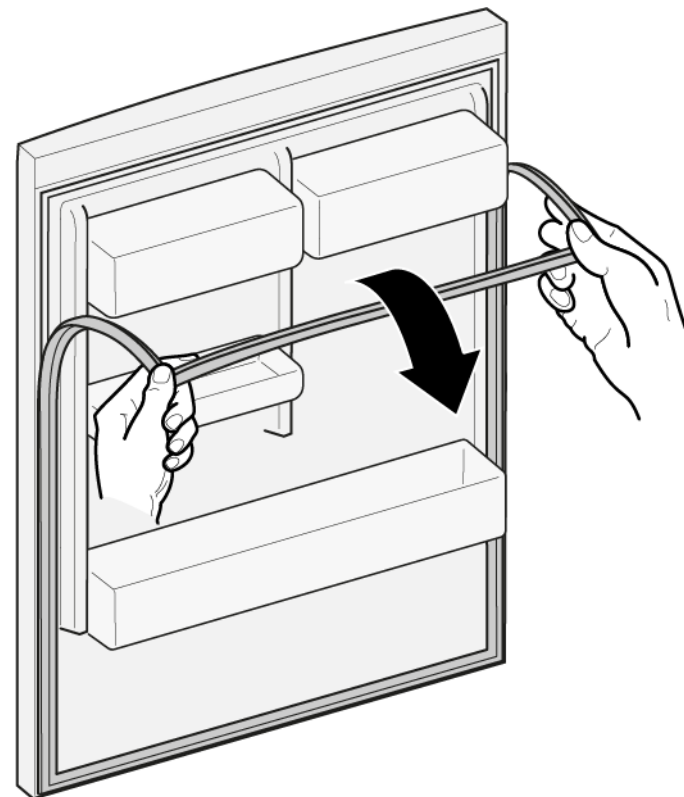

2. Demontați garnitura ușii din canelură.



- ➡ Garnitura ușii este demontată.

### 4.1.2 Montarea garniturii ușii

	Grosimea garniturii noi a ușii poate fi ușor diferită față de grosimea garniturii vechi a ușii. Acest lucru nu va afecta comportamentul de închidere și funcționarea pe termen lung.
	Dacă aparatul dumneavoastră are balamale reglabile sau accesorii pentru balamale, puteți optimiza comportamentul de închidere în consecință.
	Orificiile de mici dimensiuni practicate în garnitura ușii au rol funcțional (sunt necesare pentru ventilație). Ele nu sunt defecte ale produsului.

## Repararea

1. Verificați canelura pentru montarea garniturii și asigurați-vă că nu prezintă defecte.

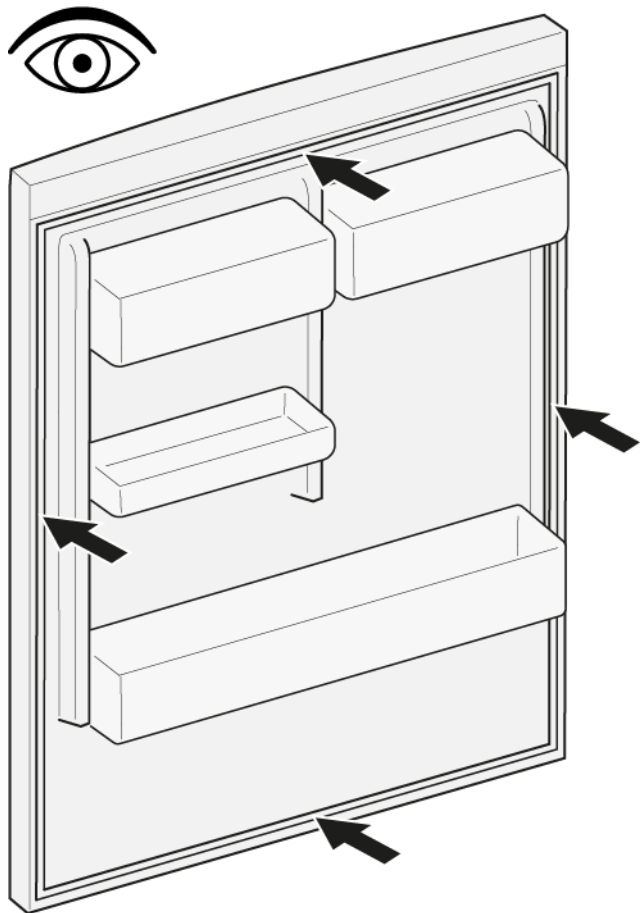

4. Împingeți colțurile de sus și de jos ale garniturii în canelură.

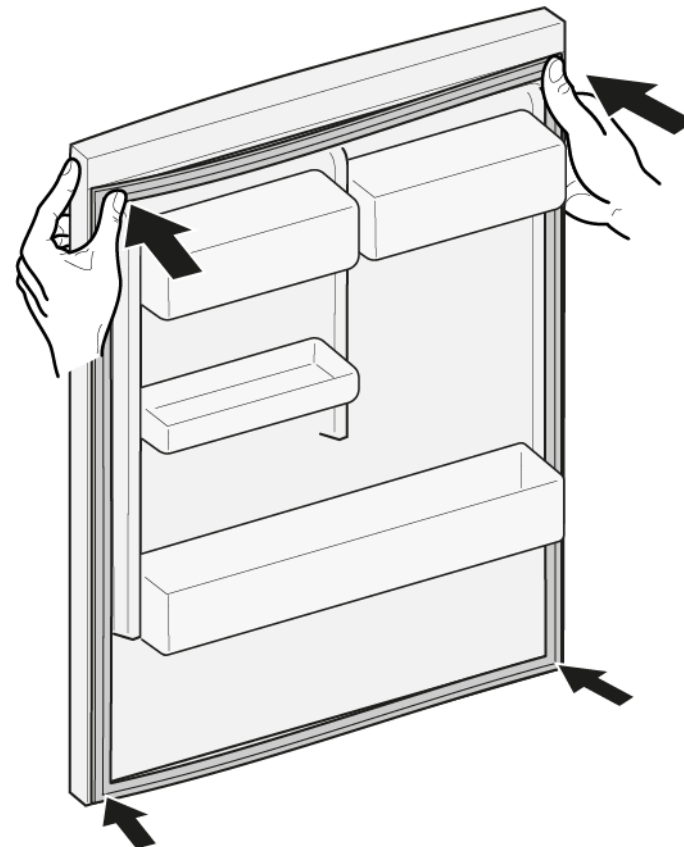

2.  Dacă canelura pentru montarea garniturii prezintă defecte, este deteriorată.  
- Contactați departamentul de service pentru clienți.

3.  O deformare ușoară a garniturii ușii este normală și nu afectează funcționarea acesteia. Se recomandă să îndreptați garnitura ușii înainte de a o introduce în aparat.

Încălziți garnitura ușii cu un uscător de păr sau cu apă fierbinte și remodelați-o cu mâna.

## Repararea

5. Apăsați întreaga garnitură în canelură, pas cu pas.

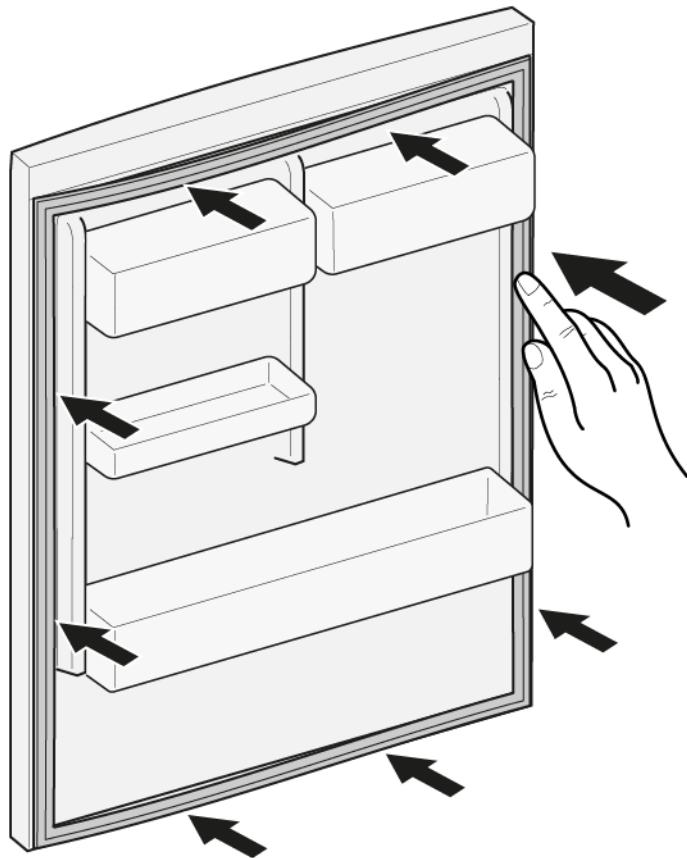



 Garnitura ușii este montată.





## 4.2 Înlocuirea mânerului ușii

### Scule speciale:

-  Cap torx TX20                      6,3 mm (1/4")                      [00340865]
-  Șurubelniță plată                      Lamă de 10 mm x 1,6 mm x 200 mm

### Cerință:

-  Aparatul este deconectat de la sursa de energie electrică.
-  Ușa este deschisă.

### 4.2.1 Demontarea mânerului ușii

- ▶ 1. Demontați două capace de șuruburi (1).
- ▶ 2. Deșurubați două șuruburi (2).
- ▶ 3. Demontați mânerul ușii (3).

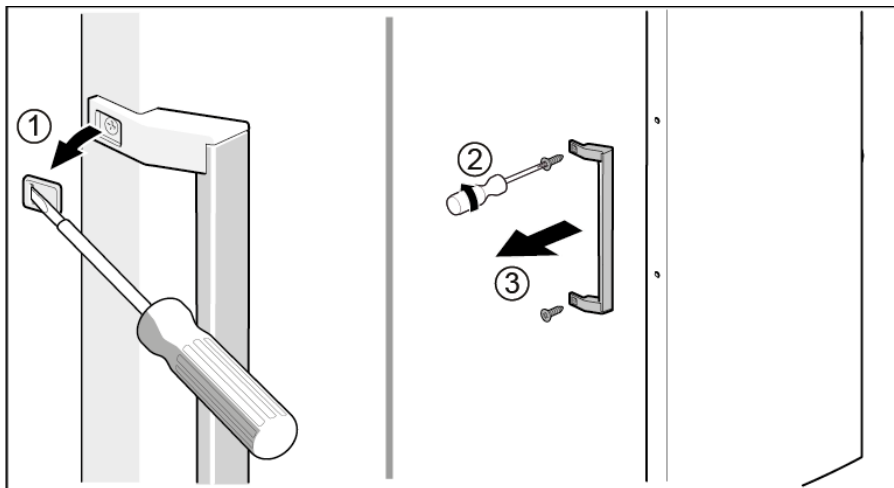

 Mânerul ușii este demontat.

### 4.2.2 Montarea mânerului ușii

- ▶ Montați urmând procedura de demontare în ordine inversă.

## 4.3 Înlocuirea easy opening handle

### Scule speciale:

🔧 Șurubelniță Phillips PH2

### Cerință:

- ✔ Aparatul este deconectat de la sursa de energie electrică.
- ✔ Ușa este deschisă.

### 4.3.1 Demontarea easy opening handle

- ▶ 1. Scoateți easy opening handle (1).
- ▶ 2. Deșurubați două șuruburi (2).

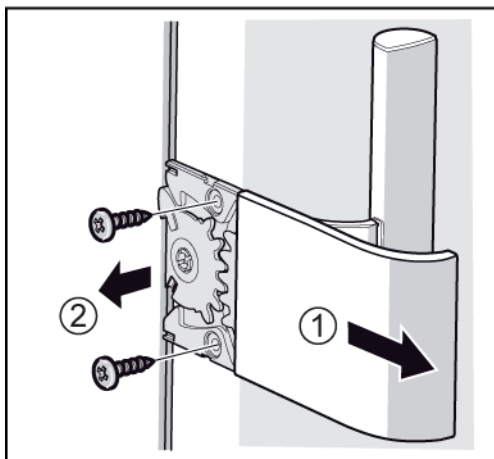

➡ Easy opening handle este demontat.

### 4.3.2 Montarea easy opening handle

Mecanismul easy opening handle trebuie să fie așezat corect înainte de montare.

Imaginea ilustrează poziționarea corectă a tije de împingere (1), a cadranelor dințate (2) și (3), a arcului (4) și a opritorului (5) ușii pentru montajul pe partea stângă.

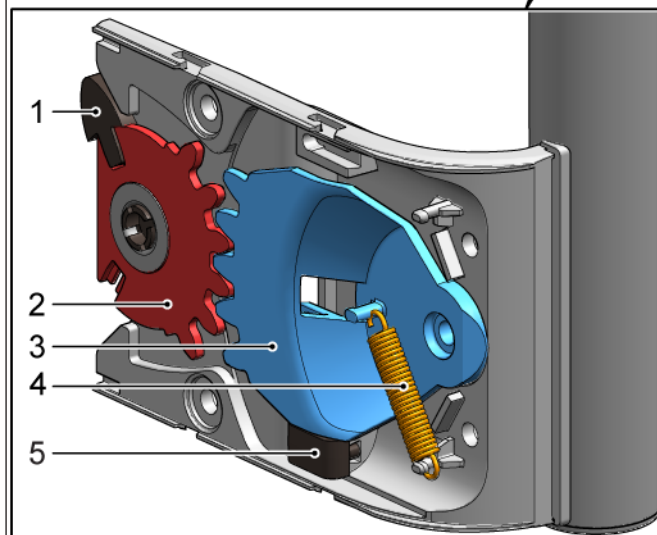
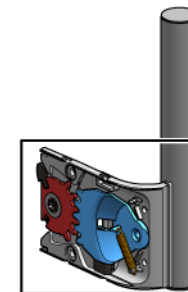



Poziționarea componentelor secundare ale easy opening handle al ușii pentru montajul pe partea dreaptă este descrisă în documentul "Instrucțiuni de montare".

- ▶ Montați urmând procedura de demontare în ordine inversă.

## 4.4 Înlocuirea balamalei de sus a ușii

### Scule speciale:

 Cap torx TX20                      6,3 mm (1/4")                      [00340865]

	<b>⚠ AVERTISMENT</b>
	<b>Aparate grele, masive!</b> Accidentarea spatelui și leziuni musculare <ul style="list-style-type: none"><li>▶ Operația de demontare a ușii aparatului trebuie efectuată numai de specialiști instruiți.</li><li>▶ Pentru deplasarea aparatului sunt necesare două persoane.</li><li>▶ Utilizați numai instrumente și echipamente adecvate.</li></ul>

	<b>⚠ ATENȚIONARE</b>
	<b>Marginea ascuțite!</b> Rănire prin tăiere <ul style="list-style-type: none"><li>▶ Purtați mănuși de protecție.</li></ul>

	<b>⚠ AVERTISMENT</b>
	<b>Alunecarea aparatelor înclinate!</b> Fracturi/zdrobiri <ul style="list-style-type: none"><li>▶ Fixați aparatele împotriva alunecării.</li></ul>

	<b>⚠ ATENȚIONARE</b>
	<b>Pericol din cauza pieselor care cad pentru că șuruburile sunt slăbite!</b> Accidente din cauza pieselor care cad. <ul style="list-style-type: none"><li>▶ Fixați componenta împotriva căderii.</li></ul>

	<b>ATENȚIE!</b>
	<b>Pericol din cauza pieselor care cad pentru că șuruburile sunt slăbite!</b> Deteriorarea altor piese ale aparatului sau a casei clientului, de exemplu, partea de jos. <ul style="list-style-type: none"><li>▶ Fixați componenta împotriva căderii.</li></ul>

### Cerință:

- ✓ Aparatul este deconectat de la sursa de energie electrică.
- ✓ Fitingurile interioare ale aparatului sunt demontate.

## 4.4.1 Demontarea balamalei ușii

## Repararea

1. Așezați aparatul pe spate.

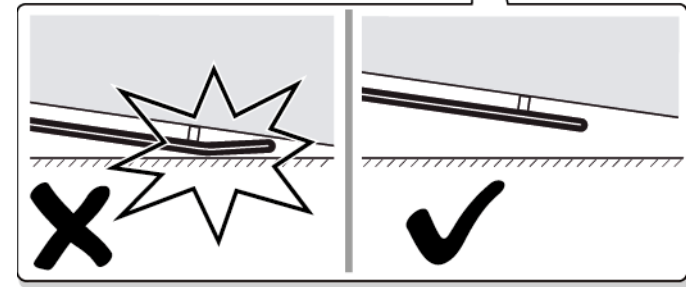
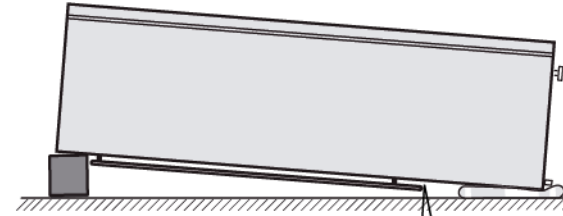
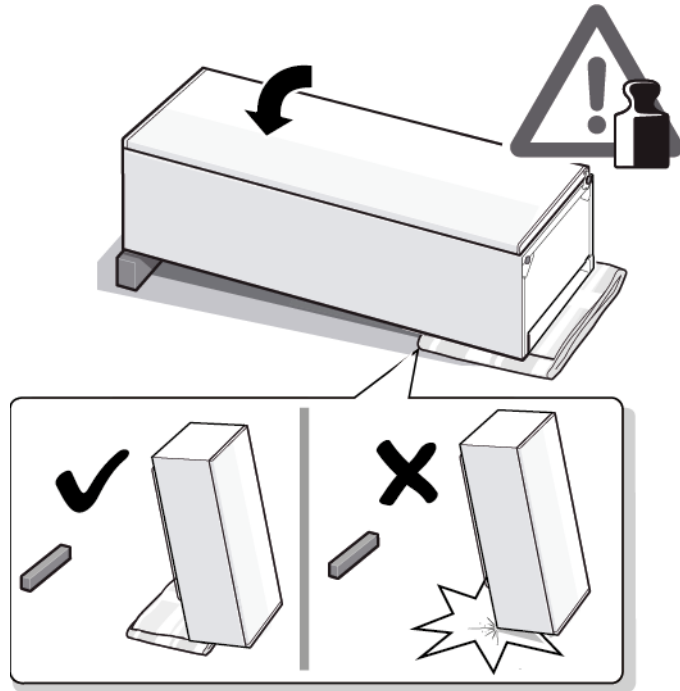

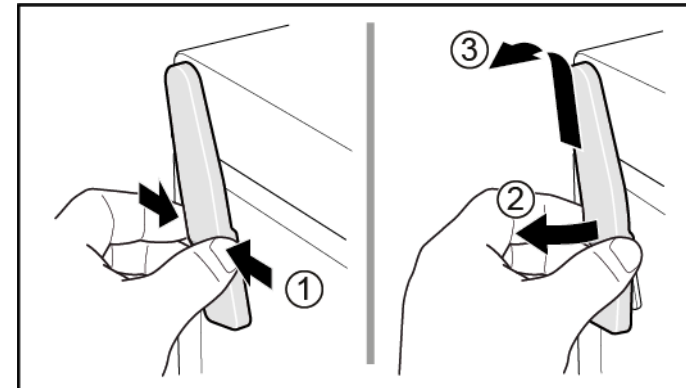

2. 1. Apăsați capacul balamalei de sus pe ambele părți laterale (1).  
2. Îndepărtați capacul balamalei de sus (2).  
3. Demontați capacul balamalei de sus (3).

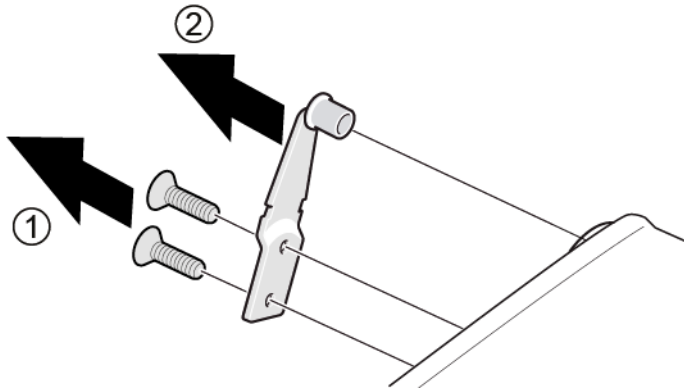

## Repararea

3.
  1. Deșurubați două șuruburi (1).
  2. Demontați balamaua de sus (2).



 Balamaua de sus și este demontată.

### 4.4.2 Montarea balamalei ușii

- ▶ Montați urmând procedura de demontare în ordine inversă.

## 4.5 Înlocuirea balamalei de sus a ușii (ușă cu afișaj)

### Scule speciale:

 Cap torx TX20                      6,3 mm (1/4")                      [00340865]

	<b>⚠️ AVERTISMENT</b>
	<p><b>Aparate grele, masive!</b> Accidentarea spatelui și leziuni musculare</p> <ul style="list-style-type: none"> <li>▶ Operația de demontare a ușii aparatului trebuie efectuată numai de specialiști instruiți.</li> <li>▶ Pentru deplasarea aparatului sunt necesare două persoane.</li> <li>▶ Utilizați numai instrumente și echipamente adecvate.</li> </ul>

	<b>⚠️ ATENȚIONARE</b>
	<p><b>Marginea ascuțită!</b> Rănire prin tăiere</p> <ul style="list-style-type: none"> <li>▶ Purtați mănuși de protecție.</li> </ul>

	<b>⚠️ AVERTISMENT</b>
	<p><b>Alunecarea aparatelor înclinate!</b> Fracturi/zdrobiri</p> <ul style="list-style-type: none"> <li>▶ Fixați aparatele împotriva alunecării.</li> </ul>



	<b>⚠️ ATENȚIONARE</b>
	<p><b>Pericol din cauza pieselor care cad pentru că șuruburile sunt slăbite!</b> Accidente din cauza pieselor care cad.</p> <ul style="list-style-type: none"> <li>▶ Fixați componenta împotriva căderii.</li> </ul>

	<b>ATENȚIE!</b>
	<p><b>Pericol din cauza pieselor care cad pentru că șuruburile sunt slăbite!</b> Deteriorarea altor piese ale aparatului sau a casei clientului, de exemplu, partea de jos.</p> <ul style="list-style-type: none"> <li>▶ Fixați componenta împotriva căderii.</li> </ul>

	<b>⚠️ PERICOL</b>
	<p><b>Pericol de electrocutare din cauza pieselor sub tensiune!</b> Pericol de moarte prin electrocutare în cazul unei reparații necorespunzătoare</p> <ul style="list-style-type: none"> <li>▶ Componentele electrice trebuie reparate de către electricieni calificați.</li> <li>▶ După reparație, este obligatorie efectuarea unei verificări de siguranță conform cu VDE 0701 sau cu reglementările naționale respective.</li> </ul>

	<b>⚠️ PERICOL</b>
	<p><b>Pericol de electrocutare din cauza pieselor sub tensiune!</b> Deces prin electrocutare</p> <ul style="list-style-type: none"> <li>▶ Deconectați aparatele de la sursa de alimentare cu tensiune cu cel puțin 60 de secunde înainte de a începe reparațiile.</li> </ul>

### Cerință:

-  Aparatul este deconectat de la sursa de energie electrică.
-  Fitingurile interioare ale aparatului sunt demontate.

### 4.5.1 Demontarea balamalei ușii

1. Așezați aparatul pe spate.

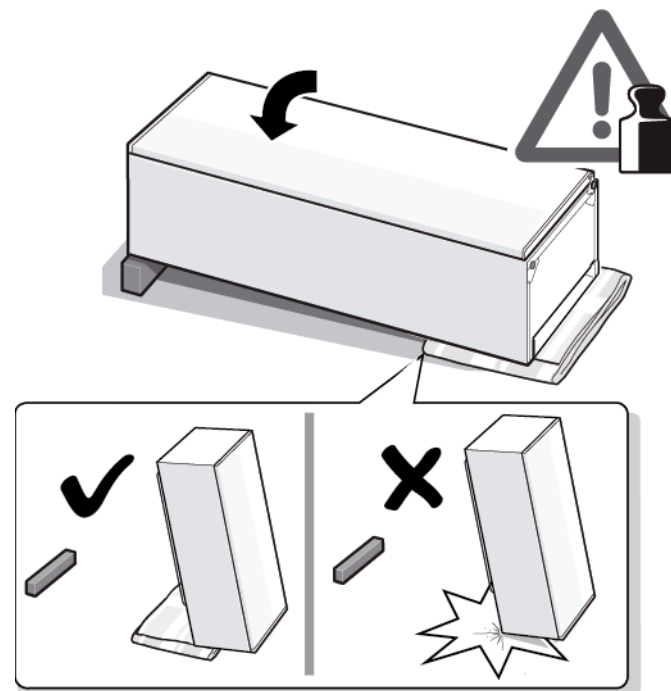

## Repararea

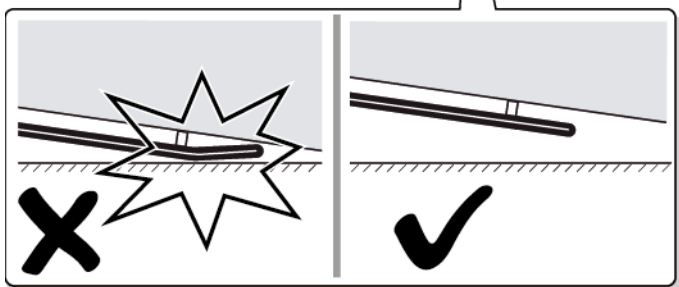
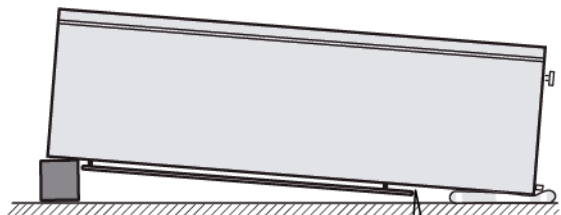

1. Apăsați capacul balamalei de sus pe ambele părți laterale (1).
2. Îndepărtați capacul balamalei de sus (2).
3. Demontați capacul balamalei de sus (3).

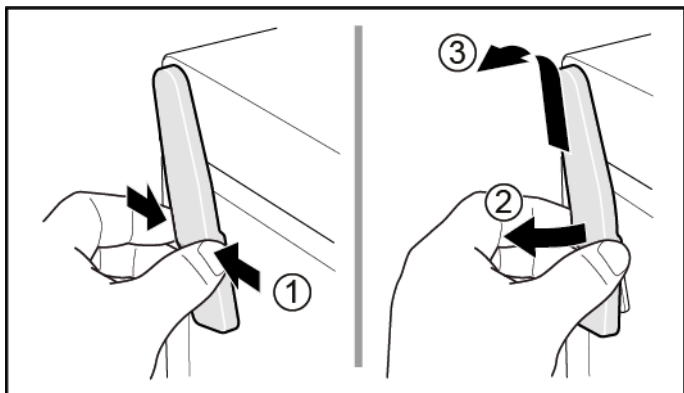

1. Demontați capacul cutiei de cabluri (1).
2. Demontați protecția cablurilor (2).
3. Deconectați conexiunea electrică (3).
4. Deșurubați două șuruburi (4).
5. Demontați balamaua de sus (5).

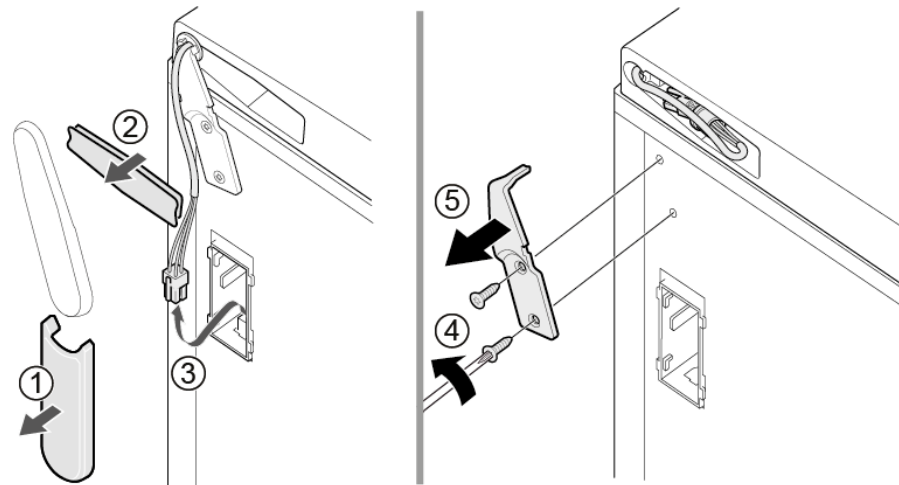

➡ Balamaua de sus și este demontată.

### 4.5.2 Montarea balamalei ușii

- ▶ Montați urmând procedura de demontare în ordine inversă.



## 4.6 Înlocuirea balamalei de jos a ușii

### Scule speciale:

🌀 Cap torx TX20

6,3 mm (1/4")

[00340865]

	<b>⚠️ AVERTISMENT</b>
	<p><b>Aparate grele, masive!</b>                  Accidentarea spatelui și leziuni musculare</p> <ul style="list-style-type: none"> <li>▶ Operația de demontare a ușii aparatului trebuie efectuată numai de specialiști instruiți.</li> <li>▶ Pentru deplasarea aparatului sunt necesare două persoane.</li> <li>▶ Utilizați numai instrumente și echipamente adecvate.</li> </ul>

	<b>⚠️ ATENȚIONARE</b>
	<p><b>Marginea ascuțită!</b>                  Rănire prin tăiere</p> <ul style="list-style-type: none"> <li>▶ Purtați mănuși de protecție.</li> </ul>

	<b>⚠️ AVERTISMENT</b>
	<p><b>Alunecarea aparatelor înclinate!</b>                  Fracturi/zdrobiri</p> <ul style="list-style-type: none"> <li>▶ Fixați aparatele împotriva alunecării.</li> </ul>

	<b>⚠️ ATENȚIONARE</b>
	<p><b>Pericol din cauza pieselor care cad pentru că șuruburile sunt slăbite!</b>                  Accidente din cauza pieselor care cad.</p> <ul style="list-style-type: none"> <li>▶ Fixați componenta împotriva căderii.</li> </ul>

	<b>ATENȚIE!</b>
	<p><b>Pericol din cauza pieselor care cad pentru că șuruburile sunt slăbite!</b>                  Deteriorarea altor piese ale aparatului sau a casei clientului, de exemplu, partea de jos.</p> <ul style="list-style-type: none"> <li>▶ Fixați componenta împotriva căderii.</li> </ul>

### Cerință:

- ✔️ Aparatul este deconectat de la sursa de energie electrică.
- ✔️ Fitingurile interioare ale aparatului sunt demontate.

- ✔️ Aparatul este așezat pe spate.
- ✔️ [Balama de sus este demontată. →422](#)

### 4.6.1 Înlocuirea balamalei de jos a ușii

1. Demontați ușa.

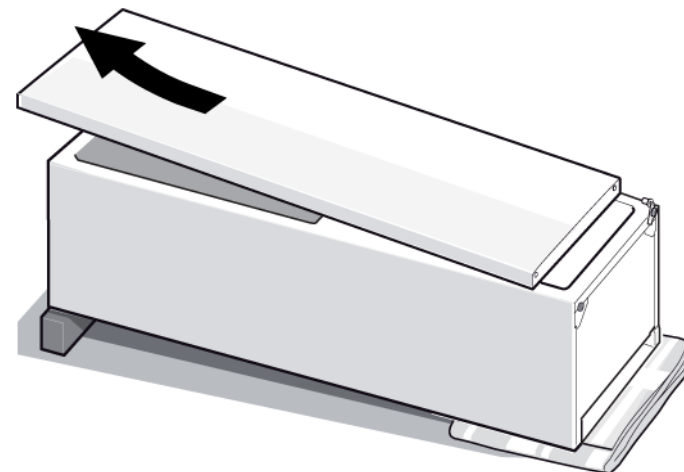

2.
  1. Deșurubați șurubul (1).
  2. Rotiți și scoateți balama de sus (2).
  3. Demontați balama de jos (3).

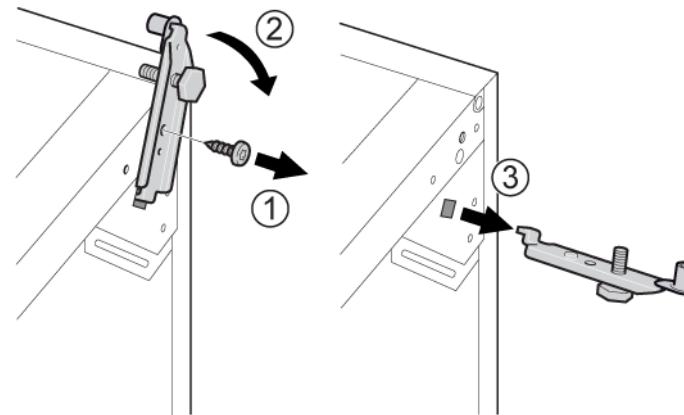

- ➡️ Balama de jos este demontată.

### **4.6.2 Montarea balamalei de jos a ușii**

- ▶ Montați urmând procedura de demontare în ordine inversă.

## 4.7 Repoziționarea raftului

### Cerință:

- ✔ Ușa este deschisă.

### 4.7.1 Demontarea raftului

- ▶ Scoateți raftul.

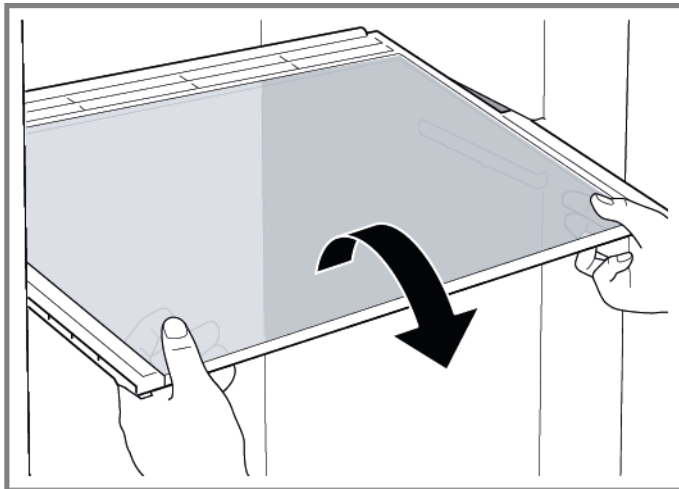

- ➡ Raftul este demontat.

### 4.7.2 Montarea raftului

- ▶ Montați urmând procedura de demontare în ordine inversă.

## 4.8 Repoziționarea containerului pentru alimente înghețate

### Cerință:

- ✓ Ușa este deschisă.

### 4.8.1 Demontarea containerului pentru alimente înghețate

- ▶ 1. Extrageți complet containerul pentru alimente înghețate (1).
- ▶ 2. Scoateți containerul pentru alimente înghețate (2).

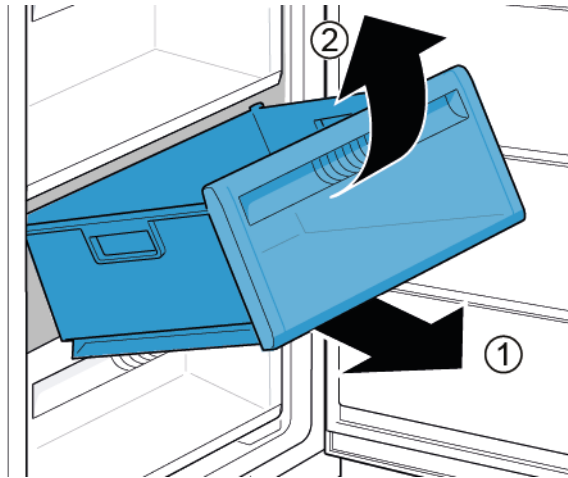

- ➡ Containerul pentru alimente înghețate este demontat.

### 4.8.2 Montarea containerului pentru alimente înghețate

- ▶ Montați urmând procedura de demontare în ordine inversă.

### 4.9 Repoziționarea recipientului pentru cuburi de gheață

#### Cerință:

- ✓ Ușa este deschisă.

#### 4.9.1 Demontarea recipientului pentru cuburi de gheață

- ▶ 1. Extrageți containerul pentru alimente înghețate cu recipientul pentru cuburi de gheață (1).
- ▶ 2. Decuplați cârligele (2).
- ▶ 3. Demontați recipientul pentru cuburi de gheață (3).

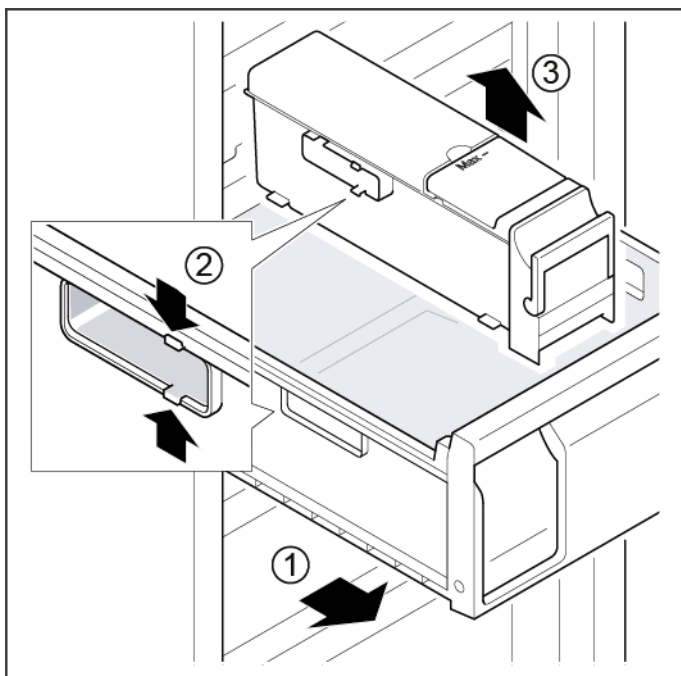

- ➡ Recipientul pentru cuburi de gheață este demontat.

#### 4.9.2 Montarea recipientului pentru cuburi de gheață

- ▶ Montați urmând procedura de demontare în ordine inversă.

## 4.10 Înlocuirea lămpii LED de sus

### Scule speciale:

-  Șurubelniță plată Lamă de 2,4 mm x 0,4 mm x 60 mm, în kitul [00341820]



	Aparatul dumneavoastră este echipat cu o lampă LED care nu necesită întreținere. Aceste lămpi pot fi înlocuite numai de către departamentul de service pentru clienți sau de către tehnicieni autorizați!
---	---

	<b>⚠ PERICOL</b> <b>Pericol de electrocutare din cauza pieselor sub tensiune!</b> Pericol de moarte prin electrocutare în cazul unei reparații necorespunzătoare <ul style="list-style-type: none"><li>▶ Componentele electrice trebuie reparate de către electricieni calificați.</li><li>▶ După reparație, este obligatorie efectuarea unei verificări de siguranță conform cu VDE 0701 sau cu reglementările naționale respective.</li></ul>
--	---

	<b>⚠ PERICOL</b> <b>Pericol de electrocutare din cauza pieselor sub tensiune!</b> Deces prin electrocutare <ul style="list-style-type: none"><li>▶ Deconectați aparatele de la sursa de alimentare cu tensiune cu cel puțin 60 de secunde înainte de a începe reparațiile.</li></ul>
--	--

	<b>⚠ ATENȚIONARE</b> <b>Marginea ascuțită!</b> Rănire prin tăiere <ul style="list-style-type: none"><li>▶ Purtați mănuși de protecție.</li></ul>
--	--

### Cerință:

-  Aparatul este deconectat de la sursa de energie electrică.
-  Ușa este deschisă.
-  Fitingurile interioare din partea de sus sunt demontate.

### 4.10.1 Demontarea lămpii LED

1. Deplasați lampa LED spre stânga.

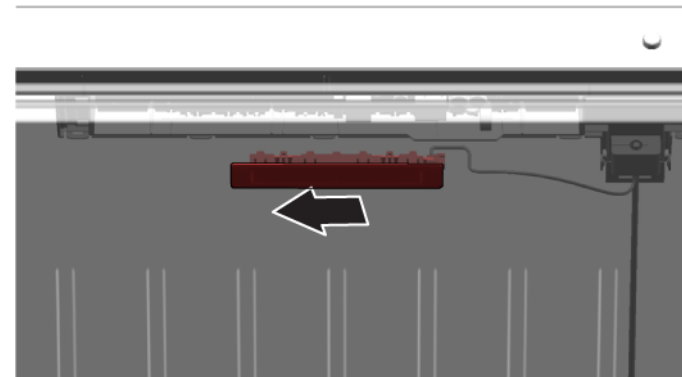

-  Conexiunea electrică a lămpii LED este deconectată.

2. Decuplați cârligele lămpii LED.

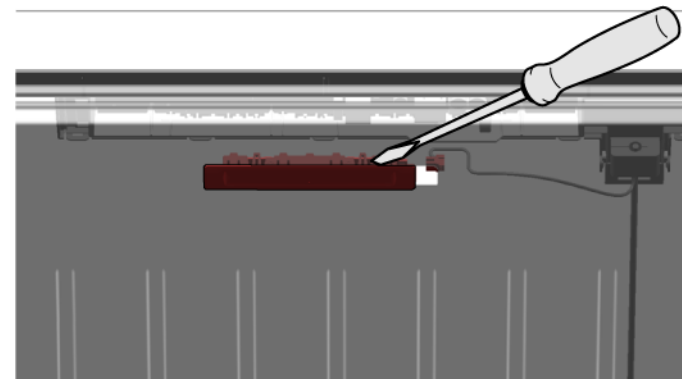

## Repararea

3. Demontați lampa LED deplasând-o în față.

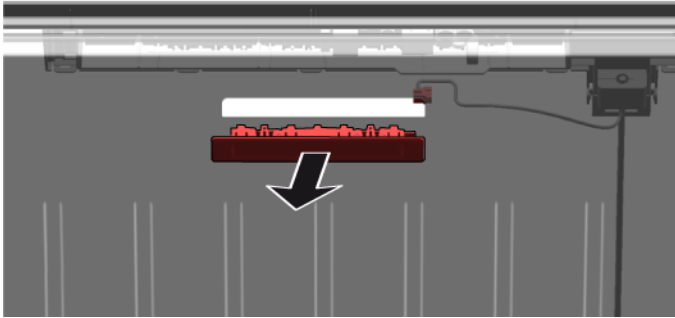

- ➔ Lampa LED este demontată.

### 4.10.2 Montarea lămpii LED de sus

- ▶ Montați urmând procedura de demontare în ordine inversă.

# Poznámky k opravám - Mraznička

 <b>O tomto dokumente</b> .....	<b>433</b>
1.1 Dôležité informácie .....	433
1.1.1 Účel .....	433
1.2 Vysvetlenie symbolov .....	433
1.2.1 Úrovne nebezpečenstva .....	433
1.2.2 Symboly označujúce riziká.....	433
1.2.3 Štruktúra varovaní.....	434
1.2.4 Všeobecné symboly .....	434
 <b>Bezpečnosť</b> .....	<b>435</b>
2.1 Všeobecné bezpečnostné pokyny .....	435
2.1.1 Všetky domáce spotrebiče.....	435
 <b>Nástroje a pomôcky</b> .....	<b>436</b>
 <b>Oprava</b> .....	<b>437</b>
4.1 Výmena tesnenia dvierok .....	437
4.1.1 Odoberanie tesnenia dvierok .....	437
4.1.2 Montáž tesnenia dvierok.....	437
4.2 Výmena dverovej úchytky .....	440
4.2.1 Odoberanie dverovej úchytky.....	440
4.2.2 Montáž dverovej úchytky .....	440
4.3 Výmena úchytky easy opening handle .....	441
4.3.1 Odoberanie úchytky easy opening handle .....	441
4.3.2 Montáž úchytky easy opening handle .....	441
4.4 Výmena horného závesu dverí .....	442
4.4.1 Odoberanie závesu dvierok .....	442
4.4.2 Montáž závesu dvierok.....	444
4.5 Výmena horného závesu dvierok (dvierka s displejom) .....	445
4.5.1 Odoberanie závesu dvierok .....	446
4.5.2 Montáž závesu dvierok.....	447
4.6 Výmena spodného závesu dvierok .....	448
4.6.1 Výmena spodného závesu dvierok.....	448
4.6.2 Montáž spodného závesu dvierok .....	449
4.7 Výmena odkladacej plochy.....	450
4.7.1 Odoberanie odkladacej plochy.....	450
4.7.2 Montáž odkladacej plochy .....	450

4.8 Výmena nádoby na zmrazené potraviny .....	451
4.8.1 Odoberanie nádoby na zmrazené potraviny .....	451
4.8.2 Montáž nádoby na zmrazené potraviny.....	451
4.9 Výmena výrobníka ľadu.....	452
4.9.1 Odoberanie výrobníka ľadu.....	452
4.9.2 Montáž výrobníka ľadu.....	452
4.10 Výmena horného LED svetla .....	453
4.10.1 Odoberanie LED osvetlenia .....	453
4.10.2 Montáž horného LED svetla .....	454



# **i** O tomto dokumente

## 1.1 Dôležité informácie

### 1.1.1 Účel

Tieto pokyny pre opravu pomáhajú spotrebiteľovi pri vlastnej oprave spotrebičov podľa nariadenia o ekodizajne (z marca 2021).

Obsahujú informácie o výmene určených náhradných dielov vrátane varovaní a rizík.

Ak máte otázky, kontaktujte náš zákaznícky servis. Za poškodenia ručíme len vtedy, ak pokyny boli dodržané správne.

## 1.2 Vysvetlenie symbolov

### 1.2.1 Úrovne nebezpečenstva

Úroveň varovania obsahuje symbol a signalizačné slovo. Signalizačné slovo naznačuje mieru nebezpečenstva.





Úroveň varovania	Význam
 <b>NEBEZPEČENSTVO</b>	Následkom nerešpektovania varovného hlásenia je úmrtie alebo vážne zranenia.
 <b>VAROVANIE</b>	Možným následkom nerešpektovania varovného hlásenia je úmrtie alebo vážne zranenia.
 <b>UPOZORNENIE</b>	Možným následkom nerešpektovania varovného hlásenia sú mierne zranenia.
 <b>POZOR!</b>	Možným následkom nerešpektovania varovného hlásenia je poškodenie majetku.

Tabuľka 1: Úrovne nebezpečenstva



### 1.2.2 Symboly označujúce riziká

Symboly označujúce riziká sú symbolické znázornenia, ktoré naznačujú druh nebezpečenstva.

V tomto dokumente sa používajú nasledujúce symboly označujúce riziká:

Symbol označujúci riziko	Význam
	Všeobecné varovné hlásenie
	Nebezpečenstvo v súvislosti s elektrickým napätím
	Nebezpečenstvo výbuchu
	Nebezpečenstvo porezania
	Nebezpečenstvo pomliaždenia

## **i** O tomto dokumente

Symbol označujúci riziko	Význam
	Nebezpečenstvo v súvislosti s horúcimi povrchmi
	Nebezpečenstvo v súvislosti s magnetickým poľom
	Nebezpečenstvo v súvislosti s neionizujúcou radiáciou

Tabuľka 2: Symboly označujúce riziká

### 1.2.3 Štruktúra varovaní

Varovania v tomto dokumente majú štandardný vzhľad a štandardnú štruktúru.



	<p><b>⚠ NEBEZPEČENSTVO</b></p> <p><b>Druh a zdroj nebezpečenstva!</b> Možné následky pri ignorovaní nebezpečenstva/varovania.</p> <ul style="list-style-type: none"> <li>▶ Opatrenia a zákazy na zabránenie nebezpečenstvu.</li> </ul>
--	--





Nasledujúci príklad znázorňuje varovanie pred zásahom elektrickým prúdom pri dotyku s časťami pod napätím. Je uvedené opatrenie na predídenie nebezpečenstvu.

	<p><b>⚠ NEBEZPEČENSTVO</b></p> <p><b>Nebezpečenstvo úrazu elektrickým prúdom pri dotyku s časťami pod napätím!</b> Úmrtie v dôsledku zásahu elektrickým prúdom</p> <ul style="list-style-type: none"> <li>▶ Odpojte spotrebiče od elektrického zdroja aspoň 60 sekúnd pred začiatkom opráv.</li> </ul>
---	--

### 1.2.4 Všeobecné symboly

V tomto dokumente sa používajú nasledujúce všeobecné symboly:

Všeob. symbol	Význam
	Označenie špeciálneho pokynu (textové a/alebo grafické)
	Označenie jednoduchého pokynu (len textové)

Všeob. symbol	Význam
	Označenie prepojenia na videonávod
	Označenie požadovaných nástrojov
	Označenie požadovaných podmienok
	Označenie podmienky (ak ..., potom ...)
	Označenie výsledku
[Spustenie]	Označenie klávesu alebo tlačidla
[00123456]	Označenie čísla materiálu
Stav	Označenie zobrazeného textu/okna (na displeji spotrebiča)

Tabuľka 3: Všeobecné symboly

## **2.1 Všeobecné bezpečnostné pokyny**

### **2.1.1 Všetky domáce spotrebiče**

#### **Nebezpečenstvo úrazu elektrickým prúdom pri dotyku s časťami pod napätím!**

- Chyby pri opravách na elektrických komponentoch môžu spôsobiť zásah elektrickým prúdom!
- Odpojte spotrebič od elektrickej siete aspoň 60 sekúnd pred začiatkom práce.
- Po oprave zariadenia vykonajte bezpečnostný test v súlade s nariadením VDE 0701 alebo s miestnymi nariadeniami.

#### **Riziko poranenia na ostrých hranách!**

- Noste ochranné rukavice.

#### **Riziko pomliaždenia počas opravy, údržby, riešenia problémov a servisu na ťažkých a pohybujúcich sa komponentoch**

- Noste ochrannú obuv.
- Zaisťte ťažké komponenty proti pádu.
- Nesiahajte končatinami do pohybujúcich sa komponentov.



#### **Riziko ohrozenia bezpečnosti/funkčnosti spotrebiča!**

- Používajte len originálne náhradné diely.

#### **Riziko poškodenia elektrostaticky citlivých komponentov (ESD)!**

- Nedotýkajte sa modulov vrátane prípojok a vedení vodičov.

## Nástroje a pomôcky

Označenie	Detaily	Snímky
Ochranná látka [00342013]	60 cm x 50 cm	
Křížový skrutičovač PH2		
Bit Torx TX20 [00340865]	6,3 mm (1/4")	
Plochý skrutičovač	Čepeľ 2,4 mm x 0,4 mm x 60 mm, v sade [00341820]	

## 4.1 Výmena tesnenia dvierok

### Požiadavka:

- ✔ Dvierka sú otvorené.

### 4.1.1 Odoberanie tesnenia dvierok

1. Uvoľnite tesnenie dvierok z drážky na pravom a ľavom rohu.





2. Vytiahnite tesnenie z drážky.



- ➡ Tesnenie dvierok je odobraté.

### 4.1.2 Montáž tesnenia dvierok

	Hrúbka nového tesnenia dvierok sa môže mierne odlišovať od hrúbky starého tesnenia dvierok. Neovplyvní to zatváranie ani funkčnosť z dlhodobého hľadiska.
	Ak má váš spotrebič nastaviteľné závesy alebo závesové úchytky, postupne môžete optimalizovať spôsob zatvárania.
	Malé bočné diery v tesnení dvierok majú svoju funkciu (sú potrebné na vetranie). Nie sú výrobnou chybou.

1. Skontrolujte poškodenie drážky na tesnenie.

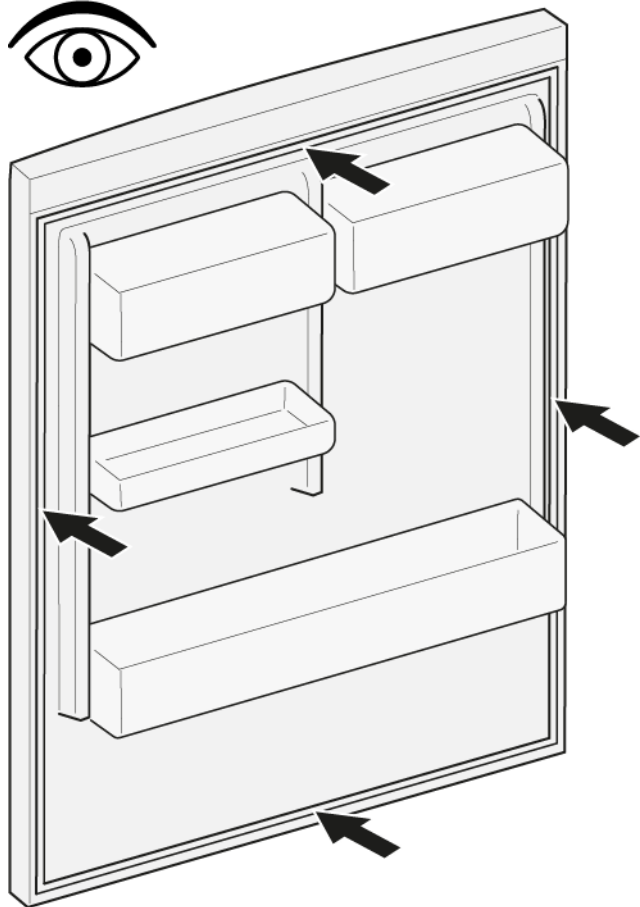

4. Hore a dole vtláčte rohy tesnenia do drážky.

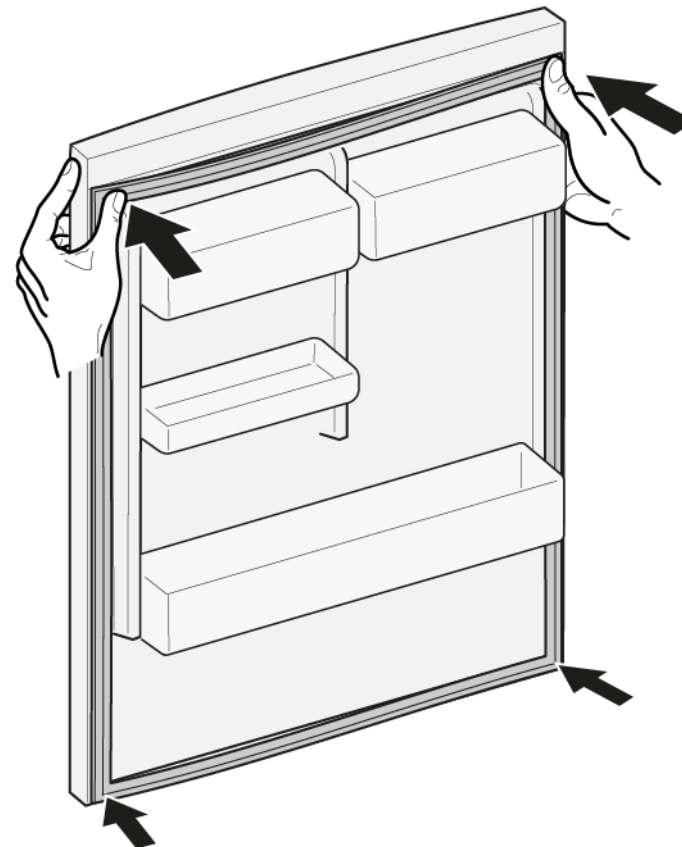

2.  Ak je drážka tesnenia je poškodená.  
- Kontaktujte zákaznícky servis.

3.  Mierna deformácia tesnenia dvierok je normálna a neovplyvňuje jeho funkciu. Odporúča sa vyrovnať tesnenie pred jeho vloženíom do spotrebiča.

Nahrejte tesnenie dvierok použitím fénu alebo horúcej vody a manuálne ho vytvarujte.

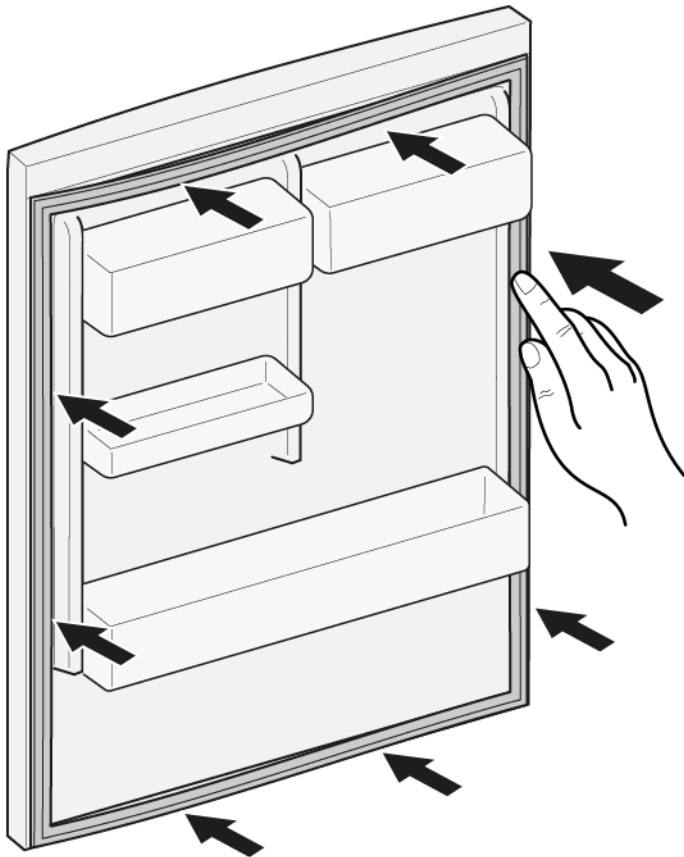

5. Jedno miesto po druhom vtlačte celé tesnenie do drážky.





-  Tesnenie dvierok je namontované.

## 4.2 Výmena dverovej úchytky

### Špeciálne nástroje:

-  Bit Torx TX20                      6,3 mm (1/4")                      [00340865]
-  Plochý skrutkovač                      Čepel' 10 mm x 1,6 mm x 200 mm

### Požiadavka:

-  Spotrebič je odpojený od elektrického napájania.
-  Dvierka sú otvorené.

### 4.2.1 Odoberanie dverovej úchytky

- ▶ 1. Odoberte dve krytky skrutiek (1).
- ▶ 2. Odskrutkujte dve skrutky (2).
- ▶ 3. Odoberte dverovú úchytку (3).

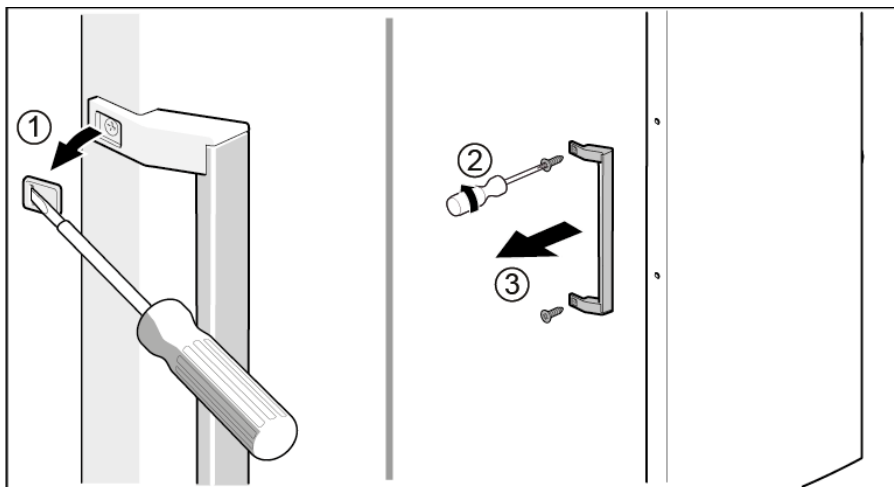

-  Dverová úchytka je odobratá.

### 4.2.2 Montáž dverovej úchytky

- ▶ Pri montáži postupujte v opačnom poradí krokov demontáže.



## 4.3 Výmena úchytky easy opening handle

### Špeciálne nástroje:

- Křížový šroubovák PH2

### Požiadavka:

- ✓ Spotřebič je odpojený od elektrického napájania.
- ✓ Dvierka sú otvorené.

### 4.3.1 Odoberanie úchytky easy opening handle

1. Odoberte kryt úchytky easy opening handle (1).
2. Odskrutkujte dve skrutky (2).

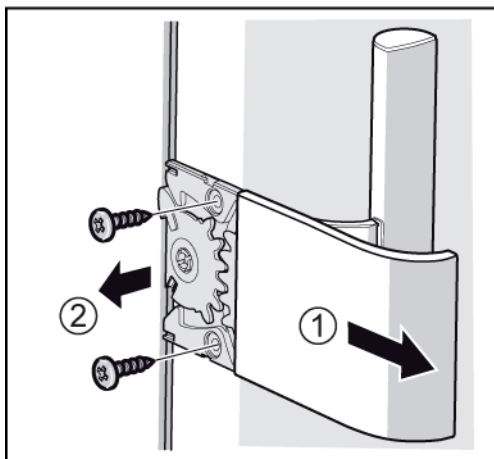

- ➔ Úchytka easy opening handle je odobratá.

## 4.3.2 Montáž úchytky easy opening handle

Mechanizmus úchytky easy opening handle by sa mal pred inštaláciou riadne nastaviť. Správne usporiadanie stláčacej tyče (1), ozubených kvadrantov (2) a (3), pružiny (4) a zarážky (5) pre montáž dveriek z ľavej strany je zobrazené na obrázku.

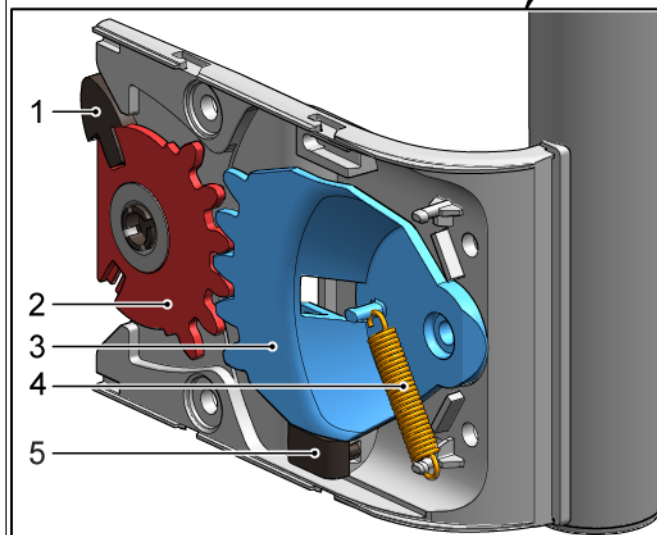
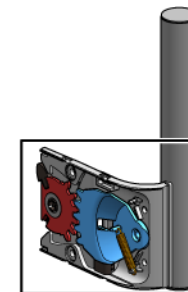

Usporiadanie súčiastok úchytky easy opening handle pre montáž na pravej strane je popísané v dokumente „Pokyny k inštalácii“.

- ➔ Pri montáži postupujte v opačnom poradí krokov demontáže.

## 4.4 Výmena horného závesu dverí

### Špeciálne nástroje:

 Bit Torx TX20                      6,3 mm (1/4")                      [00340865]

	<b>VAROVANIE</b>
	<b>Ťažké, objemné spotrebiče!</b> Poranenie chrbta a svalov <ul style="list-style-type: none"><li>▶ Proces odoberania dverok spotrebiča by mal vykonávať školený odborník.</li><li>▶ Na presunutie spotrebiča sa vyžadujú dve osoby.</li><li>▶ Použite vhodné nástroje a vybavenie.</li></ul>

	<b>UPOZORNENIE</b>
	<b>Ostré hrany!</b> Rezné poranenia <ul style="list-style-type: none"><li>▶ Noste ochranné rukavice.</li></ul>

	<b>VAROVANIE</b>
	<b>Zošmyknutie naklonených spotrebičov!</b> Zlomeniny/pomliaždenia <ul style="list-style-type: none"><li>▶ Zaistite spotrebiče proti zošmyknutiu.</li></ul>

	<b>UPOZORNENIE</b>
	<b>Riziko pádu dielov po uvoľnení skrutiek!</b> Zranenie padajúcimi dielmi. <ul style="list-style-type: none"><li>▶ Zaistite komponent proti pádu.</li></ul>

	<b>POZOR!</b>
	<b>Riziko pádu dielov po uvoľnení skrutiek!</b> Poškodenie iných častí spotrebiča alebo domácnosti zákazníka, napr. podlahy. <ul style="list-style-type: none"><li>▶ Zaistite komponent proti pádu.</li></ul>

### Požiadavka:

- ✔ Spotrebič je odpojený od elektrického napájania.
- ✔ Tvarovky z interiéru spotrebiča sú odobraté.

## 4.4.1 Odoberanie závesu dverok

1. Spotřebič dajte na zadnú stranu.

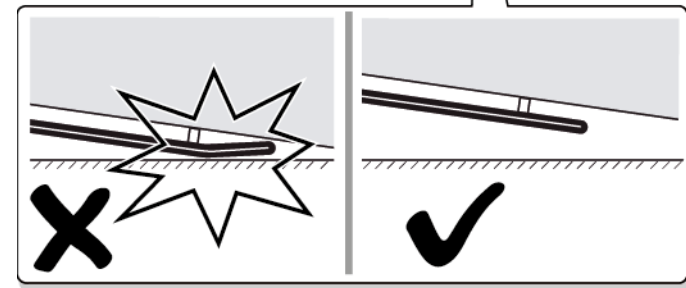
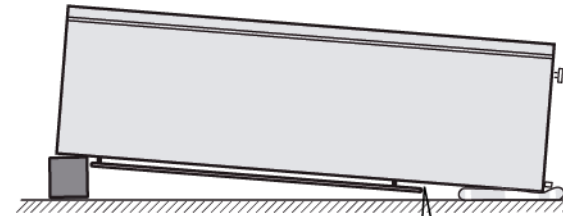
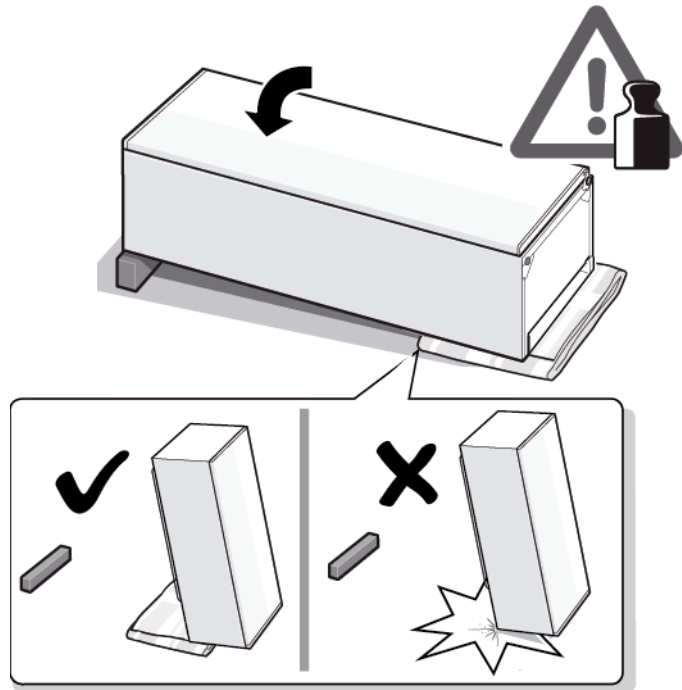

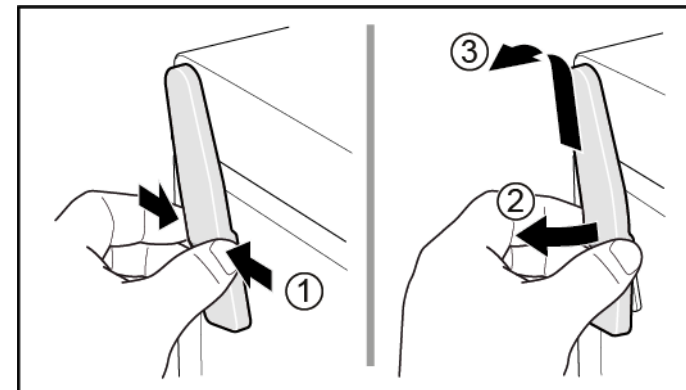

2. 1. Na oboch stranách stlačte kryt horného závěsu (1).  
2. Vytiahnite kryt horného závěsu (2).  
3. Odoberte kryt horného závěsu (3).

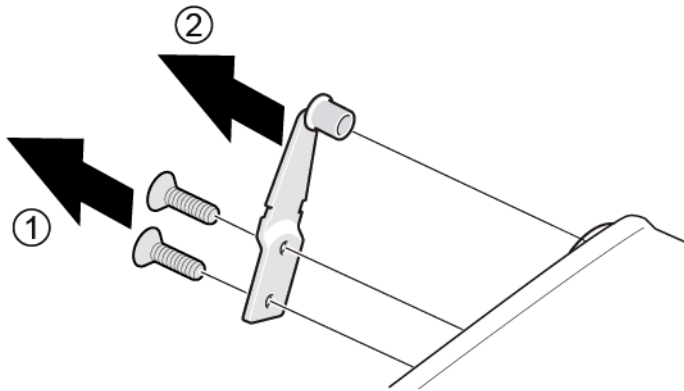

## Oprava

3. 1. Odskrutkujte dve skrutky (1).
2. Odoberte horný záves (2).



 Horný záves dvierok je odobratý.

### 4.4.2 Montáž závesu dvierok

- ▶ Pri montáži postupujte v opačnom poradí krokov demontáže.

## 4.5 Výmena horného závesu dvierok (dvierka s displejom)

Špeciálne nástroje:

 Bit Torx TX20      6,3 mm (1/4")      [00340865]

	<b>VAROVANIE</b>
	<p><b>Ťažké, objemné spotrebiče!</b> Poranenie chrbta a svalov</p> <ul style="list-style-type: none"> <li>▶ Proces odoberania dvierok spotrebiča by mal vykonávať školený odborník.</li> <li>▶ Na presunutie spotrebiča sa vyžadujú dve osoby.</li> <li>▶ Použite vhodné nástroje a vybavenie.</li> </ul>

	<b>UPOZORNENIE</b>
	<p><b>Ostré hrany!</b> Rezné poranenia</p> <ul style="list-style-type: none"> <li>▶ Noste ochranné rukavice.</li> </ul>

	<b>VAROVANIE</b>
	<p><b>Zošmyknutie naklonených spotrebičov!</b> Zlomeniny/pomliaždenia</p> <ul style="list-style-type: none"> <li>▶ Zaistite spotrebiče proti zošmyknutiu.</li> </ul>



	<b>UPOZORNENIE</b>
	<p><b>Riziko pádu dielov po uvoľnení skrutiek!</b> Zranenie padajúcimi dielmi.</p> <ul style="list-style-type: none"> <li>▶ Zaistite komponent proti pádu.</li> </ul>

	<b>POZOR!</b>
	<p><b>Riziko pádu dielov po uvoľnení skrutiek!</b> Poškodenie iných častí spotrebiča alebo domácnosti zákazníka, napr. podlahy.</p> <ul style="list-style-type: none"> <li>▶ Zaistite komponent proti pádu.</li> </ul>

	<b>NEBEZPEČENSTVO</b>
	<p><b>Nebezpečenstvo úrazu elektrickým prúdom pri dotyku s časťami pod napätím!</b> Ohrozenie života spôsobené elektrickým zásahom v prípade nesprávnej opravy</p> <ul style="list-style-type: none"> <li>▶ Elektrické diely má opravovať kvalifikovaný elektrikár.</li> <li>▶ Po oprave zariadte vykonanie bezpečnostného testu v súlade s nariadením VDE 0701 alebo s miestnymi nariadeniami.</li> </ul>

	<b>NEBEZPEČENSTVO</b>
	<p><b>Nebezpečenstvo úrazu elektrickým prúdom pri dotyku s časťami pod napätím!</b> Úmrtie v dôsledku zásahu elektrickým prúdom</p> <ul style="list-style-type: none"> <li>▶ Odpojte spotrebiče od elektrického zdroja aspoň 60 sekúnd pred začiatkom opráv.</li> </ul>

**Požiadavka:**

-  Spotrebič je odpojený od elektrického napájania.
-  Tvarovky z interiéru spotrebiča sú odobraté.

**4.5.1 Odoberanie závesu dvierok**

1. Spotřebič dajte na zadnú stranu.

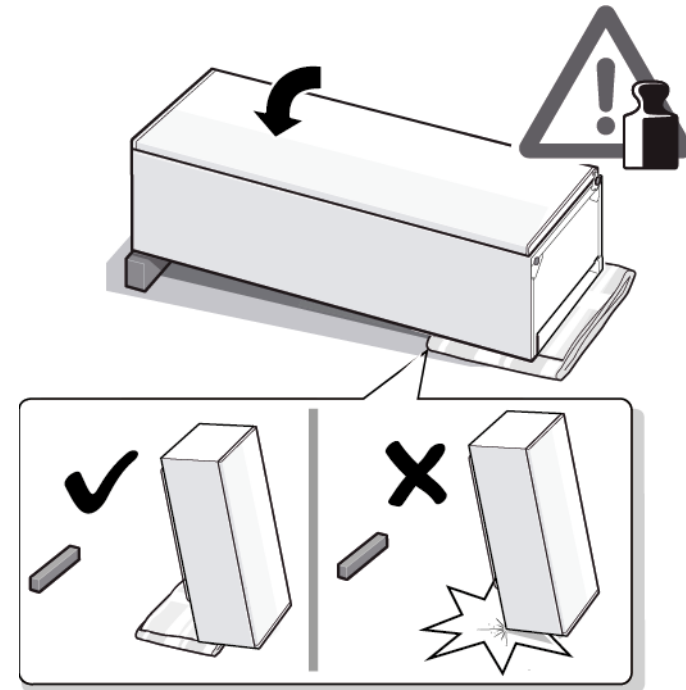

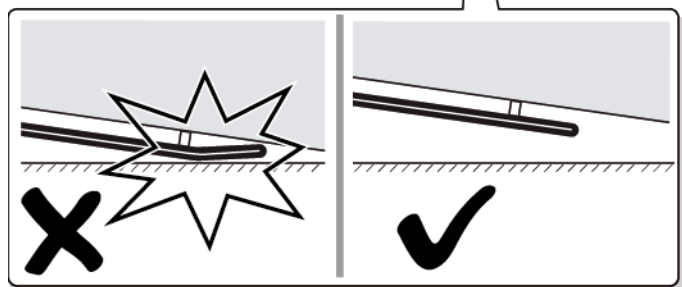
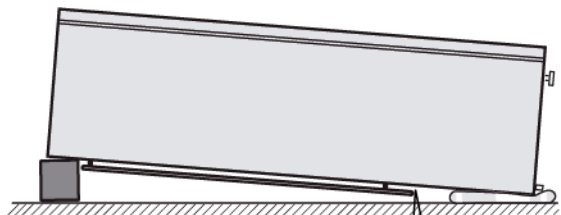

2. 1. Na oboch stranách stlačte kryt horného závesu (1).
2. Vytiahnite kryt horného závesu (2).
3. Odoberte kryt horného závesu (3).

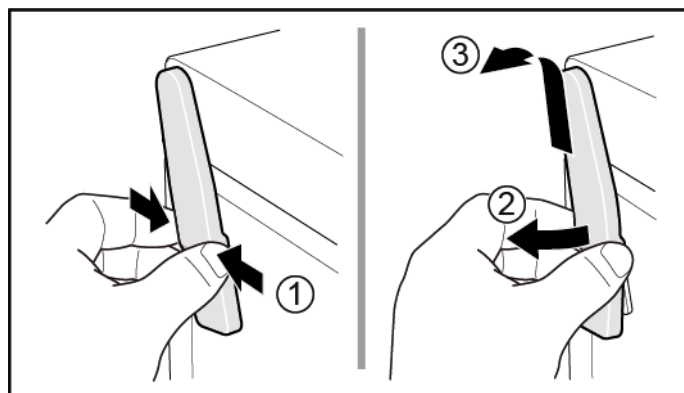

3. 1. Odoberte kryt priestoru na káble (1).
2. Odoberte ochranu kábla (2).
3. Odpojte elektrické pripojenie (3).
4. Odskrutkujte dve skrutky (4).
5. Odoberte horný záves (5).

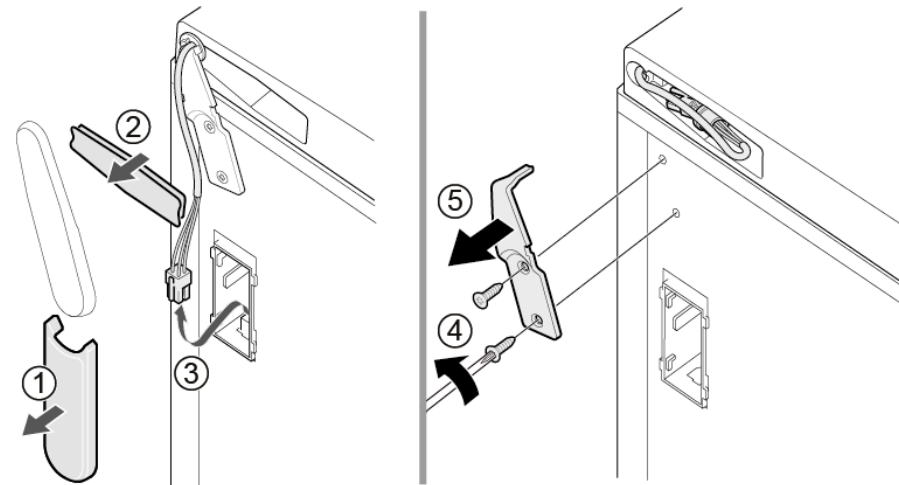

 Horný záves dvierok je odobratý.

#### 4.5.2 Montáž závesu dvierok

- ▶ Pri montáži postupujte v opačnom poradí krokov demontáže.

## 4.6 Výmena spodného závesu dvierok

Špeciálne nástroje:

 Bit Torx TX20      6,3 mm (1/4")      [00340865]

	<b>VAROVANIE</b>
	<p><b>Ťažké, objemné spotrebiče!</b> Poranenie chrbta a svalov</p> <ul style="list-style-type: none"> <li>▶ Proces odoberania dvierok spotrebiča by mal vykonávať školený odborník.</li> <li>▶ Na presunutie spotrebiča sa vyžadujú dve osoby.</li> <li>▶ Použite vhodné nástroje a vybavenie.</li> </ul>



	<b>UPOZORNENIE</b>
	<p><b>Ostré hrany!</b> Rezné poranenia</p> <ul style="list-style-type: none"> <li>▶ Noste ochranné rukavice.</li> </ul>

	<b>VAROVANIE</b>
	<p><b>Zošmyknutie naklonených spotrebičov!</b> Zlomeniny/pomliaždenia</p> <ul style="list-style-type: none"> <li>▶ Zaistite spotrebiče proti zošmyknutiu.</li> </ul>

	<b>UPOZORNENIE</b>
	<p><b>Riziko pádu dielov po uvoľnení skrutiek!</b> Zranenie padajúcimi dielmi.</p> <ul style="list-style-type: none"> <li>▶ Zaistite komponent proti pádu.</li> </ul>

	<b>POZOR!</b>
	<p><b>Riziko pádu dielov po uvoľnení skrutiek!</b> Poškodenie iných častí spotrebiča alebo domácnosti zákazníka, napr. podlahy.</p> <ul style="list-style-type: none"> <li>▶ Zaistite komponent proti pádu.</li> </ul>

Požiadavka:

-  Spotrebič je odpojený od elektrického napájania.
-  Tvarovky z interiéru spotrebiča sú odobraté.
-  Spotrebič je na zadnej strane.

 [Horný záves je odobratý. →445](#)

### 4.6.1 Výmena spodného závesu dvierok

1. Odoberte dvierka.

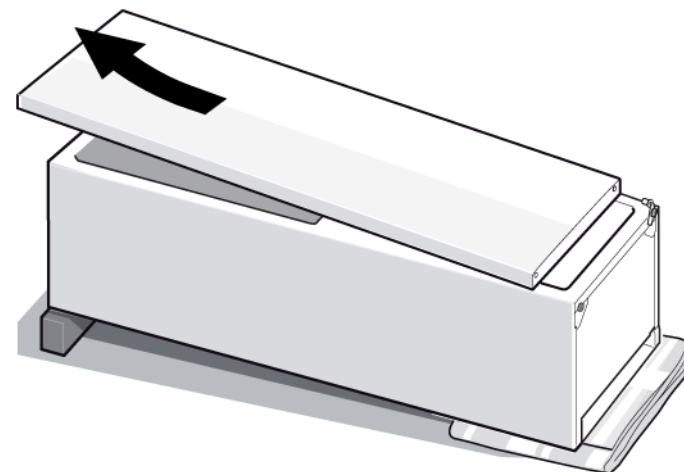

- 2.
1. Odskrutkujte skrutku (1).
  2. Otočením vyberte spodný záves (2).
  3. Odoberte spodný záves (3).

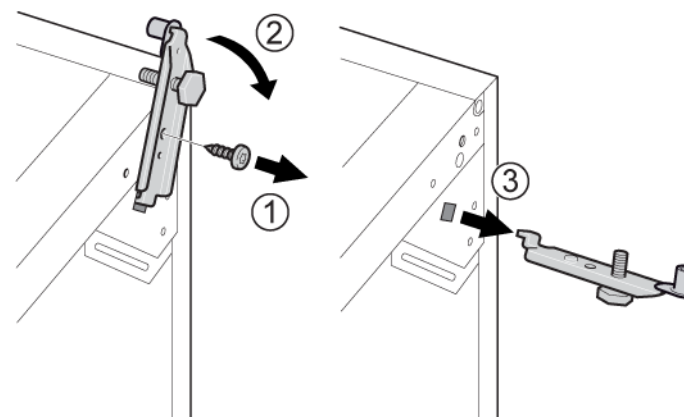

 Spodný záves je odobratý.



#### **4.6.2 Montáž spodného závesu dvierok**

- ▶ Pri montáži postupujte v opačnom poradí krokov demontáže.

## 4.7 Výmena odkladacej plochy

### Požiadavka:

- ✔ Dvierka sú otvorené.

### 4.7.1 Odobratie odkladacej plochy

- ▶ Vytiahnite odkladaciu plochu.

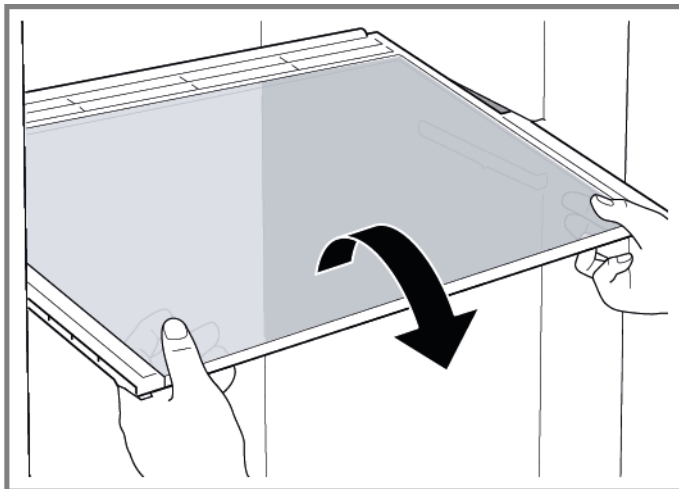

- ➡ Odkladacia plocha je odobratá.

### 4.7.2 Montáž odkladacej plochy

- ▶ Pri montáži postupujte v opačnom poradí krokov demontáže.

## 4.8 Výmena nádoby na zmrazené potraviny

### Požiadavka:

- ✔ Dvierka sú otvorené.

### 4.8.1 Odobratie nádoby na zmrazené potraviny

- ▶ 1. Úplne vytiahnite nádobu na zmrazené potraviny (1).
- ▶ 2. Odoberte nádobu na zmrazené potraviny (2).

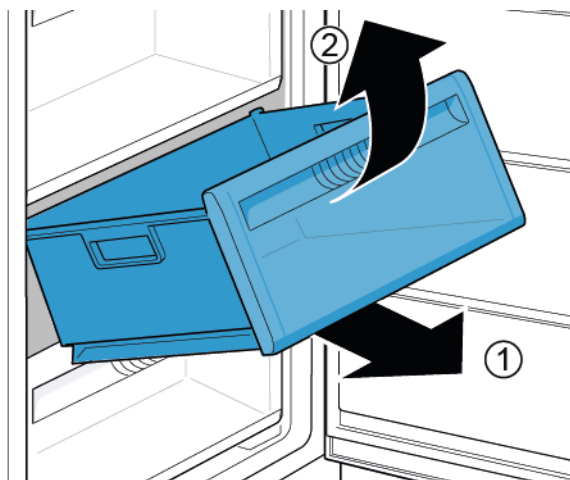

- ➡ Nádoba na zmrazené potraviny je odobratá.

### 4.8.2 Montáž nádoby na zmrazené potraviny

- ▶ Pri montáži postupujte v opačnom poradí krokov demontáže.

## 4.9 Výmena výrobníka ľadu

### Požiadavka:

- ✔ Dvierka sú otvorené.

### 4.9.1 Odobratie výrobníka ľadu

- ▶ 1. Úplne vytiahnite poličku s nádobou na zmrazené potraviny spolu s výrobníkom ľadu (1).
- ▶ 2. Uvoľnite háčiky (2).
- ▶ 3. Odoberte výrobník ľadu (3).

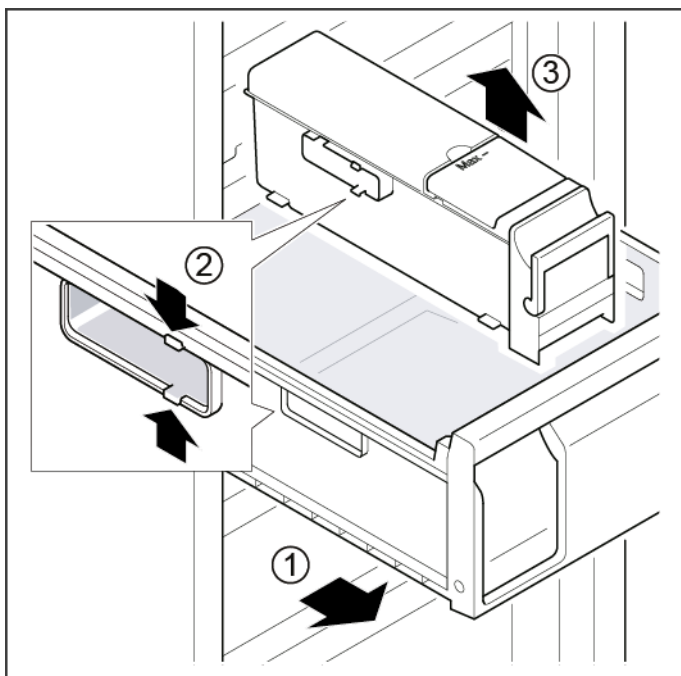

➡ Výrobník ľadu je odobratý.

### 4.9.2 Montáž výrobníka ľadu

- ▶ Pri montáži postupujte v opačnom poradí krokov demontáže.

## 4.10 Výmena horného LED svetla

### Špeciálne nástroje:

-  Plochý skrutkovač
- Čepeľ 2,4 mm x 0,4 mm x 60 mm, v sade [00341820]



	Vo výbave vášho spotrebiča je bezúdržbové LED svetlo. Tieto svetlá môže opravovať len zákaznicky servis alebo oprávnený technik!
---	--

	<b>⚠ NEBEZPEČENSTVO</b>
	<b>Nebezpečenstvo úrazu elektrickým prúdom pri dotyku s časťami pod napätím!</b> Ohrozenie života spôsobené elektrickým zásahom v prípade nesprávnej opravy
	<ul style="list-style-type: none"> <li>▶ Elektrické diely má opravovať kvalifikovaný elektrikár.</li> <li>▶ Po oprave zariadenie vykonať bezpečnostného testu v súlade s nariadením VDE 0701 alebo s miestnymi nariadeniami.</li> </ul>

	<b>⚠ NEBEZPEČENSTVO</b>
	<b>Nebezpečenstvo úrazu elektrickým prúdom pri dotyku s časťami pod napätím!</b> Úmrtie v dôsledku zásahu elektrickým prúdom
	<ul style="list-style-type: none"> <li>▶ Odpojte spotrebiče od elektrického zdroja aspoň 60 sekúnd pred začiatkom opráv.</li> </ul>

	<b>⚠ UPOZORNENIE</b>
	<b>Ostré hrany!</b> Rezné poranenia
	<ul style="list-style-type: none"> <li>▶ Noste ochranné rukavice.</li> </ul>

### Požiadavka:

-  Spotrebič je odpojený od elektrického napájania.
-  Dvierka sú otvorené.
-  Horné tvarovky z interiéru sú odobraté.

### 4.10.1 Odobratie LED osvetlenia

1. Posuňte LED svetlo na ľavú stranu.

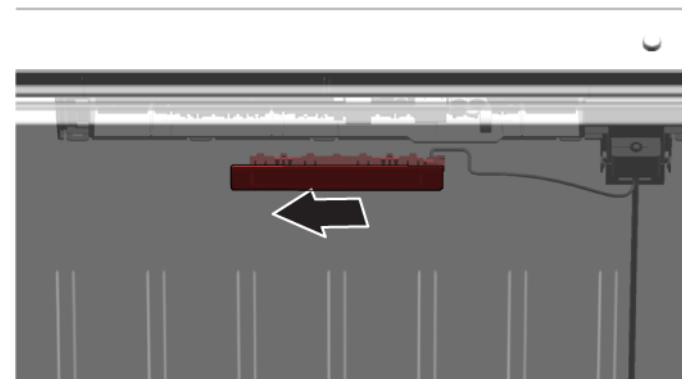

-  Elektrické pripojenie LED svetla je odpojené.

2. Uvoľnite háčiky LED svetla.

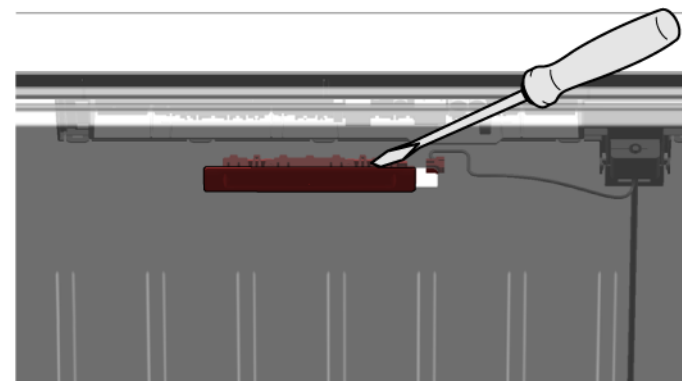

3. Presuňte LED svetlo posunutím dopredu.

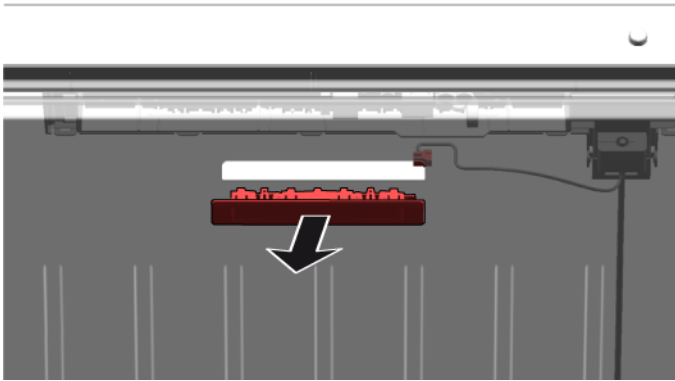

- ➔ LED svetlo je odobraté.

### 4.10.2 Montáž horného LED svetla

- ▶ Pri montáži postupujte v opačnom poradí krokov demontáže.

# Nasveti za popravilo - Zamrzovalnik

## V zvezi s tem dokumentom ..... 456

1.1	Pomembne informacije .....	456
1.1.1	Namen .....	456
1.2	Razlaga simbolov .....	456
1.2.1	Stopnje nevarnosti .....	456
1.2.2	Simboli za nevarnost .....	456
1.2.3	Struktura opozoril .....	457
1.2.4	Splošni simboli .....	457

## Varnost..... 458

2.1	Splošna varnostna navodila .....	458
2.1.1	Vsi gospodinjski aparati .....	458

## Orodja in pripomočki..... 459

## Popravilo ..... 460

4.1	Zamenjava tesnila vrat .....	460
4.1.1	Odstranjevanje tesnila vrat .....	460
4.1.2	Namestitev tesnila vrat .....	460
4.2	Zamenjava ročaja vrat .....	463
4.2.1	Odstranjevanje ročaja vrat .....	463
4.2.2	Namestitev ročaja vrat .....	463
4.3	Zamenjava ročaja easy opening handle .....	464
4.3.1	Odstranjevanje ročaja easy opening handle .....	464
4.3.2	Namestitev ročaja easy opening handle .....	464
4.4	Zamenjava zgornjega tečaja vrat .....	465
4.4.1	Odstranjevanje tečaja vrat .....	465
4.4.2	Namestitev tečaja vrat .....	467
4.5	Zamenjava zgornjega tečaja vrat (vrata s prikazovalnikom) .....	468
4.5.1	Odstranjevanje tečaja vrat .....	469
4.5.2	Namestitev tečaja vrat .....	470
4.6	Zamenjava spodnjega tečaja vrat .....	471
4.6.1	Zamenjava spodnjega tečaja vrat .....	471
4.6.2	Namestitev spodnjega tečaja vrat .....	471
4.7	Zamenjava police .....	472
4.7.1	Odstranjevanje police .....	472
4.7.2	Namestitev police .....	472

4.8	Zamenjava predala za zamrznjena živila .....	473
4.8.1	Odstranjevanje predala za zamrznjena živila .....	473
4.8.2	Namestitev predala za zamrznjena živila .....	473
4.9	Zamenjava ledomata .....	474
4.9.1	Odstranjevanje ledomata .....	474
4.9.2	Namestitev ledomata .....	474
4.10	Zamenjava zgornje lučke LED .....	475
4.10.1	Odstranjevanje lučke LED .....	475
4.10.2	Namestitev zgornje lučke LED .....	476

# **i** V zvezi s tem dokumentom

## 1.1 Pomembne informacije

### 1.1.1 Namen

Ti namigi za popravila uporabnika podpirajo pri lastnoročnem popravilu aparatov skladno z veljavno direktivo glede okoljsko primerne zasnove (od marca 2021).

Vsebujejo informacije o tem, kako zamenjati določene rezervne dele, vključno z opozorili in tveganji.

Če imate kakšna vprašanja, se obrnite na našo servisno službo. Za škodo bomo odgovorni le, če ste namige za popravila upoštevali pravilno.

## 1.2 Razlaga simbolov

### 1.2.1 Stopnje nevarnosti

Stopnje opozoril so sestavljene iz simbola in signalne besede. Signalna beseda označuje stopnjo nevarnosti.





Stopnja opozorila	Pomen
 <b>NEVARNOST</b>	Neupoštevanje opozorilnega sporočila bo povzročilo smrt ali hude poškodbe.
 <b>OPOZORILO</b>	Neupoštevanje opozorilnega sporočila lahko povzroči smrt ali hude poškodbe.
 <b>PREVIDNO</b>	Neupoštevanje opozorilnega sporočila lahko povzroči manjše poškodbe.
 <b>POZOR!</b>	Neupoštevanje opozorilnega sporočila lahko povzroči škodo na lastnini.

*Preglednica 1: Stopnje nevarnosti*

### 1.2.2 Simboli za nevarnost



Simboli za nevarnost so simbolni prikazi, ki podajajo informacije o vrsti nevarnosti.

V tem dokumentu so uporabljeni naslednji simboli za nevarnost:

Simbol za nevarnost	Pomen
	Splošno opozorilno sporočilo
	Nevarnost zaradi električne napetosti
	Nevarnost eksplozije
	Nevarnost ureznin
	Nevarnost zmečkanin



## **i** V zvezi s tem dokumentom

Simbol za nevarnost	Pomen
	Nevarnost zaradi vročih površin
	Nevarnost zaradi močnega magnetnega polja
	Nevarnost zaradi neionizirajočega sevanja

Preglednica 2: Simboli za nevarnost

### 1.2.3 Struktura opozoril

Opozorila v tem dokumentu imajo standardiziran videz in standardizirano strukturo.



	<div style="background-color: red; color: white; padding: 2px; text-align: center;"><b>⚠ NEVARNOST</b></div> <p><b>Vrsta in vir nevarnosti!</b> Morebitne posledice ob neupoštevanju nevarnosti/opozorila.</p> <ul style="list-style-type: none"> <li>▶ Ukrepi in prepovedi za preprečevanje nevarnosti.</li> </ul>
--	---





V naslednjem primeru je prikazano opozorilo, ki opozarja pred električnim udarom zaradi delov pod napetostjo. Naveden je ukrep za preprečevanje nevarnosti.

	<div style="background-color: red; color: white; padding: 2px; text-align: center;"><b>⚠ NEVARNOST</b></div> <p><b>Nevarnost električnega udara zaradi delov pod napetostjo!</b> Smrt zaradi električnega udara</p> <ul style="list-style-type: none"> <li>▶ Izključite aparate iz električnega omrežja vsaj 60 sekund pred začetkom popravil.</li> </ul>
---	---

### 1.2.4 Splošni simboli

V tem dokumentu so uporabljeni naslednji splošni simboli:

Splošni simbol	Pomen
	Identifikacija posebnega nasveta (besedilo in/ali slika)
	Identifikacija preprostega nasveta (samo besedilo)
	Identifikacija povezave na video vadnico

Splošni simbol	Pomen
	Identifikacija potrebnih orodij
	Identifikacija potrebnih predpogojev
	Identifikacija pogoja (če ..., potem ...)
	Identifikacija rezultata
Začetek	Identifikacija tipke ali gumba
[00123456]	Identifikacija številke dela
Stanje	Identifikacija prikazanega besedila/okna (na zaslonu aparata)

Preglednica 3: Splošni simboli

## 2.1 Splošna varnostna navodila

### 2.1.1 Vsi gospodinjski aparati

#### **Nevarnost električnega udara zaradi delov pod napetostjo!**

- Napake zaradi popravil električnih komponent lahko povzročijo električni udar!
- Aparat izključite iz električnega omrežja vsaj 60 sekund pred začetkom del.
- Po popravilu je treba izvesti preizkus varnosti v skladu z VDE 0701 ali predpisi, ki veljajo za posamezno državo.

#### **Nevarnost poškodb zaradi ostrih robov!**

- Uporabljajte zaščitne rokavice.

#### **Nevarnost zmečkanin med popravili, vzdrževanjem, odpravljanjem težav ali servisom zaradi težkih in premikajočih se komponent**

- Uporabljajte zaščitne čevlje.
- Težke komponente zavarujte pred padanjem.
- Delov telesa ne vstavljajte v premikajoče se komponente.



#### **Tveganje za varnost/delovanje aparata!**

- Uporabljajte le originalne nadomestne dele.

#### **Tveganje poškodb elektrostatično občutljivih komponent (ESD)!**

- Ne dotikajte se modulov, vključno s povezavami in potmi vodnika.

## Orodja in pripomočki

Oznaka	Podrobnosti	Slike
Zaščitna krpa [00342013]	60 cm x 50 cm	
Križni izvijač PH2		
Nastavek Torx TX20 [00340865]	6,3 mm (1/4")	
Ploščati izvijač	Steblo 2,4 mm x 0,4 mm x 60 mm, v kompletu [00341820]	

## 4.1 Zamenjava tesnila vrat

### Zahteva:

-  Vrata so odprta.

### 4.1.1 Odstranjevanje tesnila vrat

1. V levem in desnem kotu sprostite tesnilo vrat iz utora.

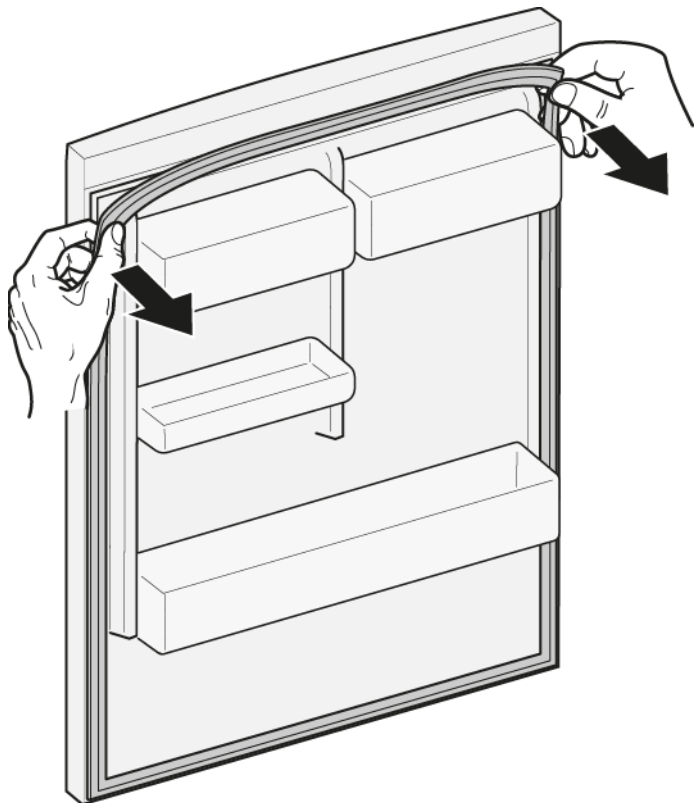

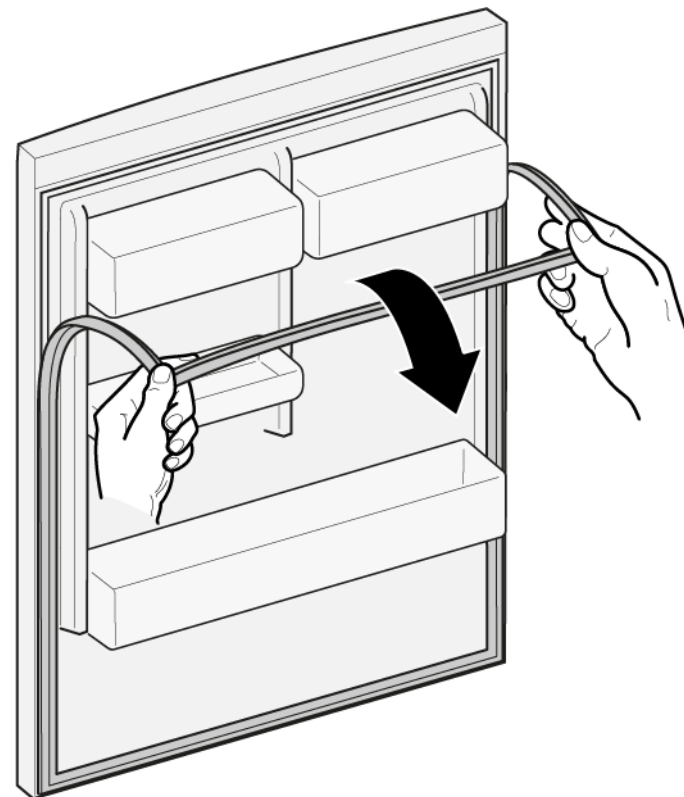

2. Tesnilo vrat izvlecite iz utora.



-  Tesnilo vrat je odstranjeno.

### 4.1.2 Namestitev tesnila vrat

	Debelina novega tesnila vrat se lahko nekoliko razlikuje od starega tesnila vrat. To ne vpliva na zapiranje in dolgoročno delovanje aparata.
	Če ima aparat nastavljive tečaje ali priključke tečajev, lahko zapiranje naknadno tudi prilagodite.
	Majhne stranske luknje v tesnilu vrat imajo svoj namen (potrebne so za prezračevanje). Ne gre za proizvodne napake.

## Popravilo

1. Preverite, ali je utor za tesnilo poškodovan.

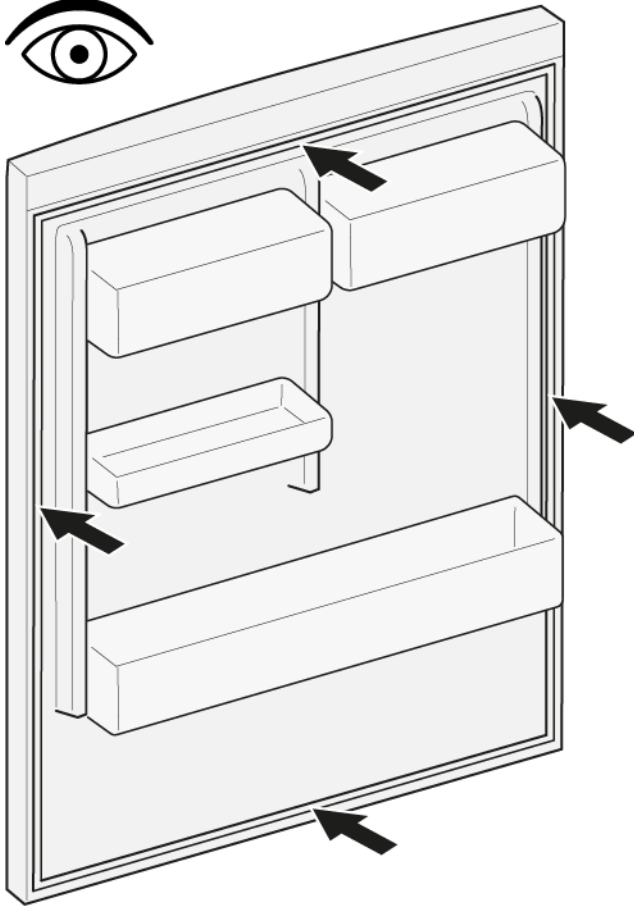

4. Vogale tesnila zgoraj in spodaj potisnite v utor.

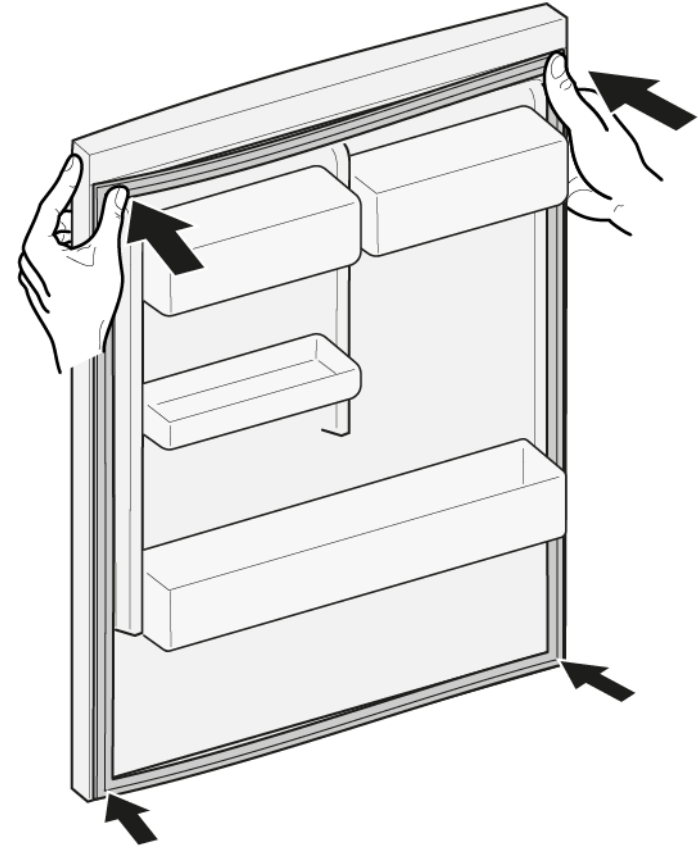

2.  Če je utor za tesnilo poškodovan:
  - se obrnite na našo servisno službo.

3.  Majhna deformacija tesnila vrat je običajna in ne vpliva na njegovo delovanje. Priporočljivo je, da tesnilo vrat pred namestitvijo v aparat poravnate.

Tesnilo vrat lahko segrejete s sušilnikom za lase ali toplo vodo, da ga ročno preoblikujete.

## Popravilo

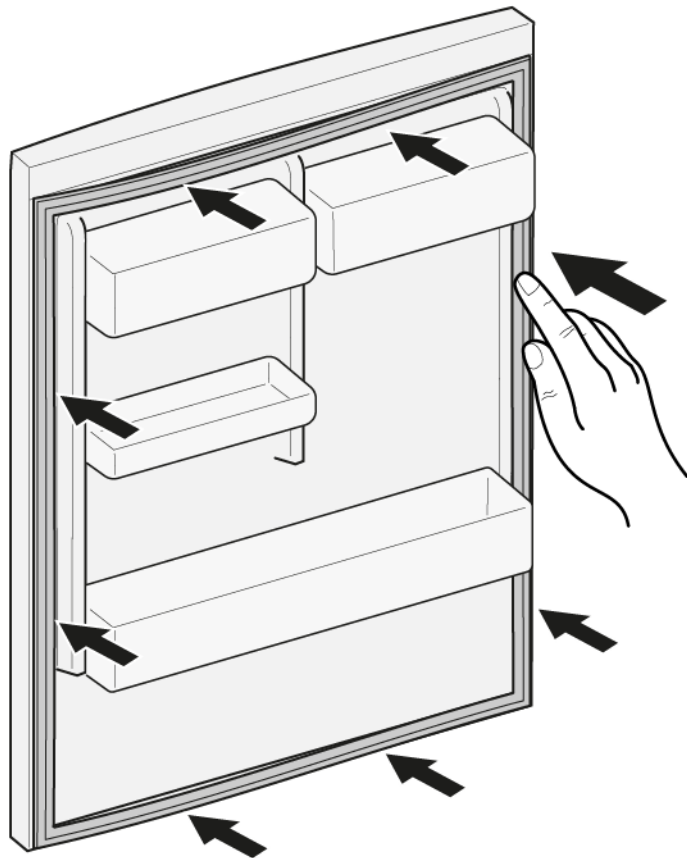

5. Celotno tesnilo korak po koraku potisnite v utor.





 Tesnilo vrat je nameščeno.

## 4.2 Zamenjava ročaja vrat

### Posebna orodja:

-  Nastavek Torx TX20                      6,3 mm (1/4")                      [00340865]
-  Ploščati izvijač                      Steblo 10 mm x 1,6 mm x 200 mm

### Zahteva:

-  Aparat je odklopljen iz omrežne napetosti.
-  Vrata so odprta.

### 4.2.1 Odstranjevanje ročaja vrat

- ▶ 1. Odstranite dva pokrovčka vijakov (1).
- ▶ 2. Odvijte vijaka (2).
- ▶ 3. Odstranite ročaj vrat (3).

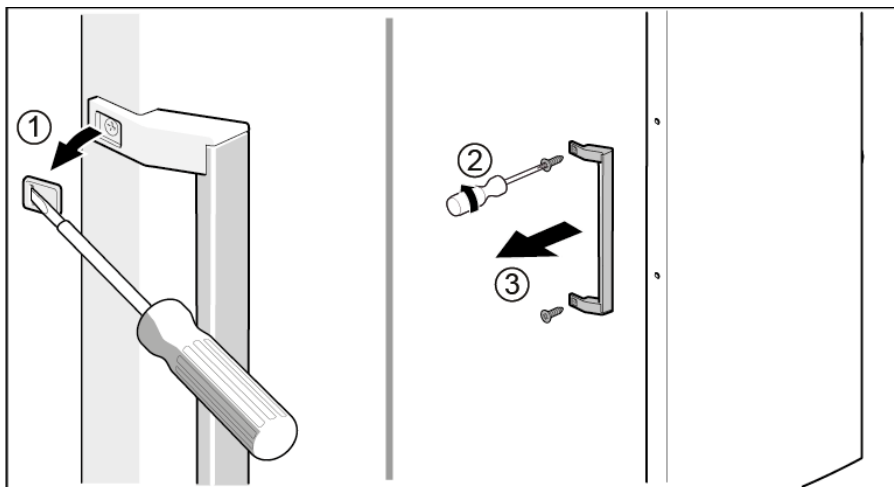

-  Ročaj vrat je odstranjen.

### 4.2.2 Namestitev ročaja vrat

- ▶ Namestite v obratnem vrstnem redu.

## 4.3 Zamenjava ročaja easy opening handle

**Posebna orodja:**

🔩 Križni izvijač PH2

**Zahteva:**

- ✅ Aparat je odklopljen iz omrežne napetosti.
- ✅ Vrata so odprta.

### 4.3.1 Odstranjanje ročaja easy opening handle

- ▶ 1. Odstranite pokrov ročaja easy opening handle (1).
- ▶ 2. Odvijte vijaka (2).

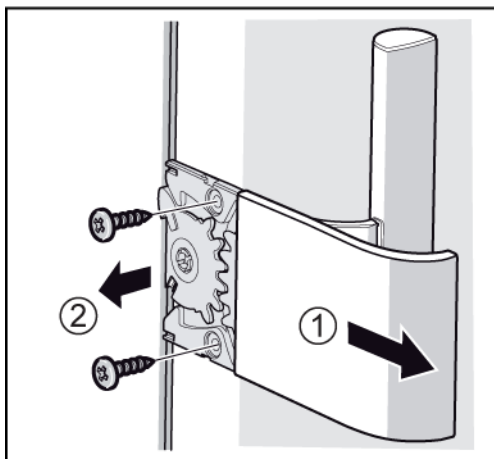

➡ Ročaj easy opening handle je odstranjen.

### 4.3.2 Namestitev ročaja easy opening handle

Mehanizem ročaja easy opening handle je treba pred namestitvijo ustrezno nastaviti.

Pravilna razporeditev potisne ročice (1), zobnih kvadrantov (2) in (3), vzmeti (4) in omejevalnika (5) za namestitev vrat na levo stran je prikazana na skici.

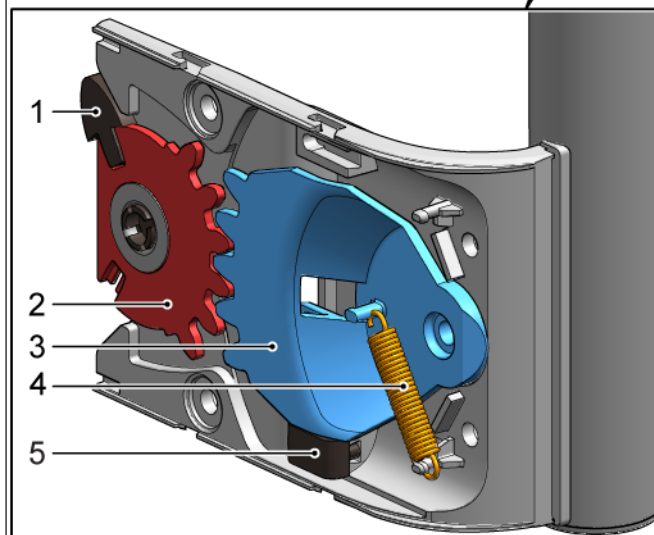
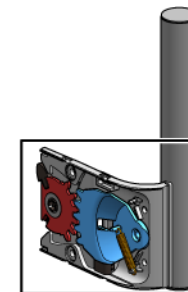

Razporeditev podelmentov ročaja easy opening handle za namestitev vrat na desno stran je opisana v dokumentu »Navodila za namestitev«.

- ▶ Namestite v obratnem vrstnem redu.





## 4.4 Zamenjava zgornjega tečaja vrat

### Posebna orodja:

 Nastavek Torx TX20      6,3 mm (1/4")      [00340865]

	<b>⚠ OPOZORILO</b>
	<b>Težki, veliki aparati!</b> Poškodbe hrbta in mišic <ul style="list-style-type: none"><li>▶ Postopek odstranjevanja vrat aparata naj izvaja samo pooblašče-no strokovno osebje.</li><li>▶ Za premikanje aparata sta potrebni dve osebi.</li><li>▶ Uporabite samo ustrezno orodje in opremo.</li></ul>

	<b>⚠ PREVIDNO</b>
	<b>Ostri robovi!</b> Ureznine <ul style="list-style-type: none"><li>▶ Uporabljajte zaščitne rokavice.</li></ul>

	<b>⚠ OPOZORILO</b>
	<b>Zdrs nagnjenih aparatov!</b> Zlomi kosti/zmečkanine <ul style="list-style-type: none"><li>▶ Aparate zaščitite pred zdrsavanjem.</li></ul>

	<b>⚠ PREVIDNO</b>
	<b>Nevarnost padajočih delov zaradi zrahljanih vijakov!</b> Poškodbe zaradi padajočih delov. <ul style="list-style-type: none"><li>▶ Komponento zaščitite pred padcem.</li></ul>

	<b>POZOR!</b>
	<b>Nevarnost padajočih delov zaradi zrahljanih vijakov!</b> Škoda na drugih delih aparata ali pri uporabniku doma, npr. na tleh. <ul style="list-style-type: none"><li>▶ Komponento zaščitite pred padcem.</li></ul>

### Zahteva:

- Aparat je odklopljen iz omrežne napetosti.
- Notranji elementi aparata so odstranjeni.

## 4.4.1 Odstranjevanje tečaja vrat

## Popravilo

1. Aparat postavite na zadnjo stran.

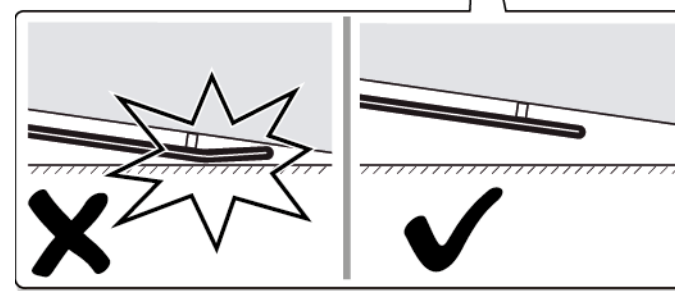
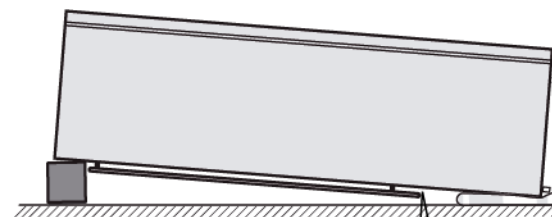
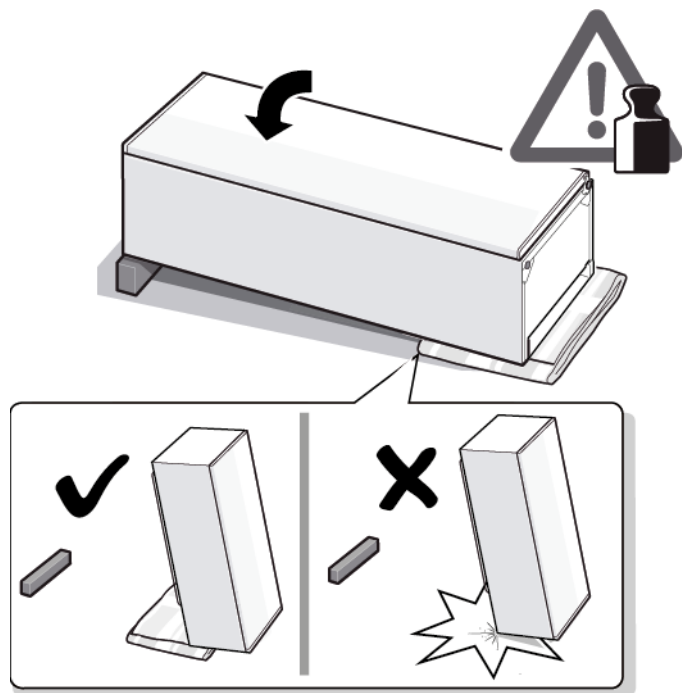

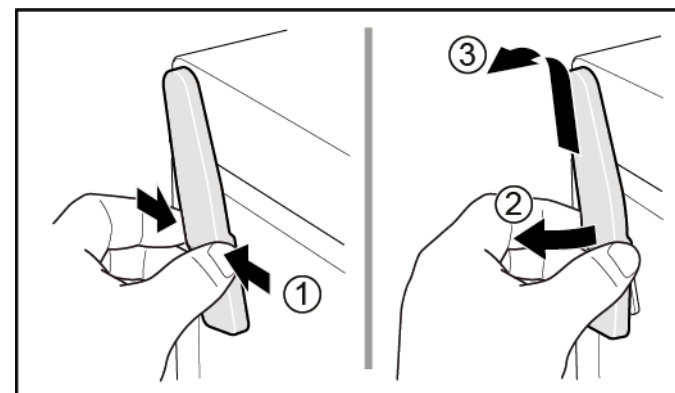

2. 1. Pokrovček zgornjega tečaja pritisnite na obeh straneh (1).  
2. Pokrovček zgornjega tečaja povlecite stran (2).  
3. Odstranite pokrovček zgornjega tečaja (3).

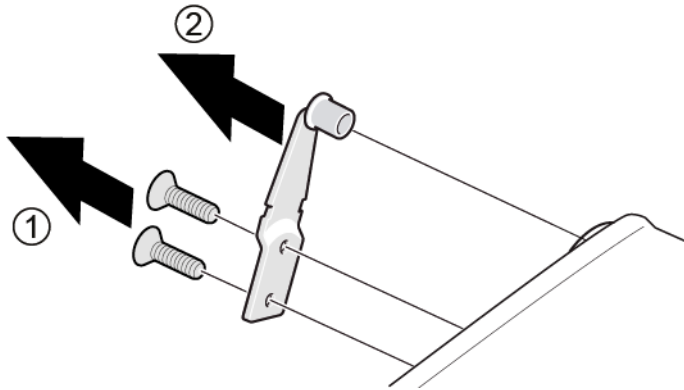

## Popravilo

3. 1. Odvijte vijaka (1).
2. Odstranite zgornji tečaj (2).



 Zgornji tečaj vrat je odstranjen.



### 4.4.2 Namestitev tečaja vrat



- ▶ Namestite v obratnem vrstnem redu.



## 4.5 Zamenjava zgornjega tečaja vrat (vrata s prikazovalnikom)



### Posebna orodja:

 Nastavek Torx TX20      6,3 mm (1/4")      [00340865]

	 <b>OPOZORILO</b>
	<p><b>Težki, veliki aparati!</b> Poškodbe hrbta in mišic</p> <ul style="list-style-type: none"> <li>▶ Postopek odstranjevanja vrat aparata naj izvaja samo pooblaščen strokovno osebje.</li> <li>▶ Za premikanje aparata sta potrebni dve osebi.</li> <li>▶ Uporabite samo ustrezno orodje in opremo.</li> </ul>

	 <b>PREVIDNO</b>
	<p><b>Ostri robovi!</b> Ureznine</p> <ul style="list-style-type: none"> <li>▶ Uporabljajte zaščitne rokavice.</li> </ul>

	 <b>OPOZORILO</b>
	<p><b>Zdrs nagnjenih aparatov!</b> Zlomi kosti/zmečkanine</p> <ul style="list-style-type: none"> <li>▶ Aparate zaščitite pred zdrsavanjem.</li> </ul>



	 <b>PREVIDNO</b>
	<p><b>Nevarnost padajočih delov zaradi zrahljanih vijakov!</b> Poškodbe zaradi padajočih delov.</p> <ul style="list-style-type: none"> <li>▶ Komponento zaščitite pred padcem.</li> </ul>

	<b>POZOR!</b>
	<p><b>Nevarnost padajočih delov zaradi zrahljanih vijakov!</b> Škoda na drugih delih aparata ali pri uporabniku doma, npr. na tleh.</p> <ul style="list-style-type: none"> <li>▶ Komponento zaščitite pred padcem.</li> </ul>

	 <b>NEVARNOST</b>
	<p><b>Nevarnost električnega udara zaradi delov pod napetostjo!</b> Življenjska nevarnost zaradi električnega udara v primeru nepravilnega popravila</p> <ul style="list-style-type: none"> <li>▶ Električne dele mora popraviti kvalificiran električar.</li> <li>▶ Po popravilu je treba izvesti preizkus varnosti v skladu z VDE 0701 ali predpisi, ki veljajo za posamezno državo.</li> </ul>

	 <b>NEVARNOST</b>
	<p><b>Nevarnost električnega udara zaradi delov pod napetostjo!</b> Smrt zaradi električnega udara</p> <ul style="list-style-type: none"> <li>▶ Izključite aparate iz električnega omrežja vsaj 60 sekund pred začetkom popravil.</li> </ul>

#### Zahteva:

-  Aparat je odklopljen iz omrežne napetosti.
-  Notranji elementi aparata so odstranjeni.

## 4.5.1 Odstranjevanje tečaja vrat

1. Aparat postavite na zadnjo stran.

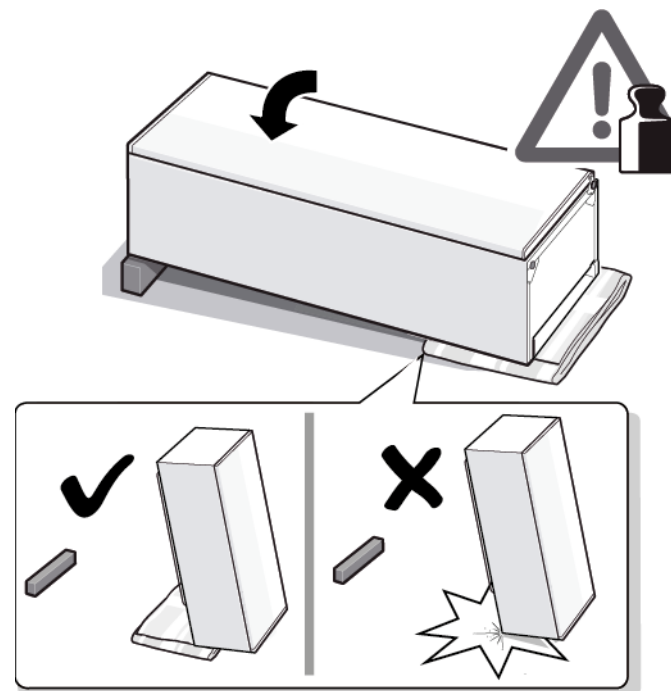

## Popravilo

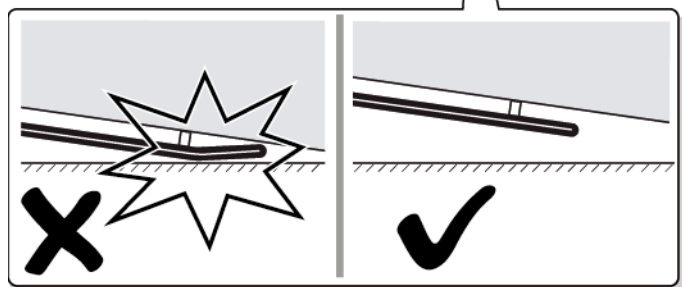
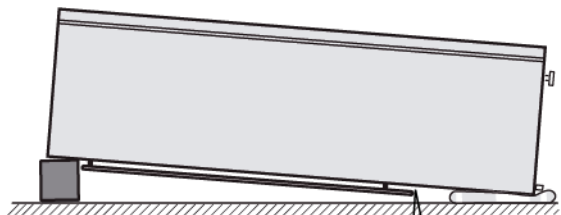

1. Pokrovček zgornjega tečaja pritisnite na obeh straneh (1).
2. Pokrovček zgornjega tečaja povlecite stran (2).
3. Odstranite pokrovček zgornjega tečaja (3).

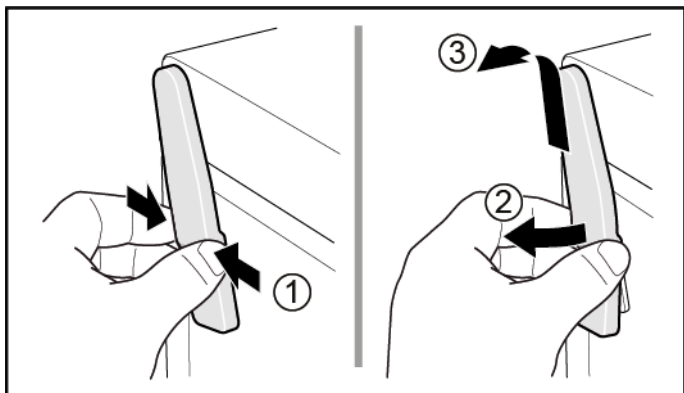

3. 1. Odstranite pokrovček odprtine za kable (1).
2. Odstranite kabelsko zaščito (2).
3. Odklopite električno povezavo (3).
4. Odvijte vijaka (4).
5. Odstranite zgornji tečaj (5).

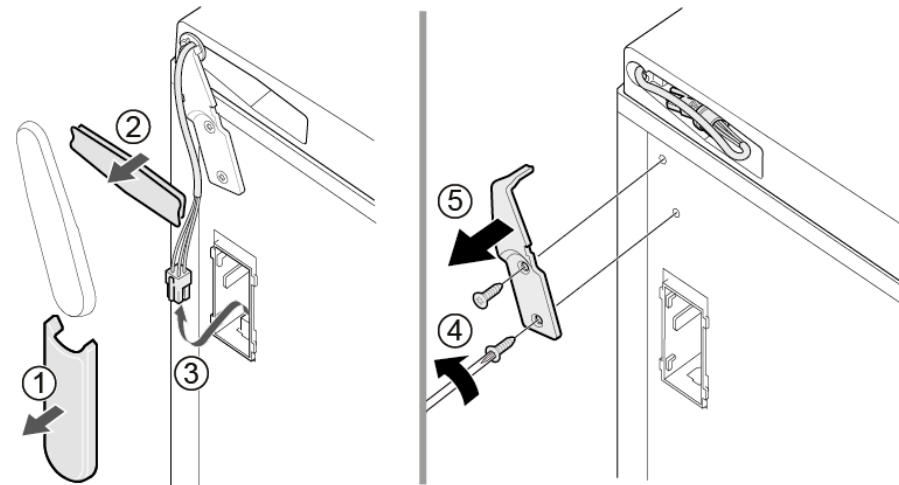

 Zgornji tečaj vrat je odstranjen.

### 4.5.2 Namestitev tečaja vrat

- ▶ Namestite v obratnem vrstnem redu.

## 4.6 Zamenjava spodnjega tečaja vrat

Posebna orodja:

🔧 Nastavek Torx TX20      6,3 mm (1/4")      [00340865]

	<b>⚠️ OPOZORILO</b>
<p><b>Težki, veliki aparati!</b> Poškodbe hrbta in mišic</p> <ul style="list-style-type: none"> <li>▶ Postopek odstranjevanja vrat aparata naj izvaja samo pooblašče-no strokovno osebje.</li> <li>▶ Za premikanje aparata sta potrebni dve osebi.</li> <li>▶ Uporabite samo ustrezno orodje in opremo.</li> </ul>	

	<b>⚠️ PREVIDNO</b>
<p><b>Ostri robovi!</b> Ureznine</p> <ul style="list-style-type: none"> <li>▶ Uporabljajte zaščitne rokavice.</li> </ul>	

	<b>⚠️ OPOZORILO</b>
<p><b>Zdrs nagnjenih aparatov!</b> Zlomi kosti/zmečkanine</p> <ul style="list-style-type: none"> <li>▶ Aparate zaščitite pred zdrsavanjem.</li> </ul>	

	<b>⚠️ PREVIDNO</b>
<p><b>Nevarnost padajočih delov zaradi zrahljanih vijakov!</b> Poškodbe zaradi padajočih delov.</p> <ul style="list-style-type: none"> <li>▶ Komponento zaščitite pred padcem.</li> </ul>	

	<b>POZOR!</b>
<p><b>Nevarnost padajočih delov zaradi zrahljanih vijakov!</b> Škoda na drugih delih aparata ali pri uporabniku doma, npr. na tleh.</p> <ul style="list-style-type: none"> <li>▶ Komponento zaščitite pred padcem.</li> </ul>	

Zahteva:

- ✔ Aparat je odklopljen iz omrežne napetosti.
- ✔ Notranji elementi aparata so odstranjeni.
- ✔ Aparat je postavljen na zadnjo stran.
- ✔ [Zgornji tečaj je odstranjen. → 468](#)

### 4.6.1 Zamenjava spodnjega tečaja vrat

1. Odstranite vrata.

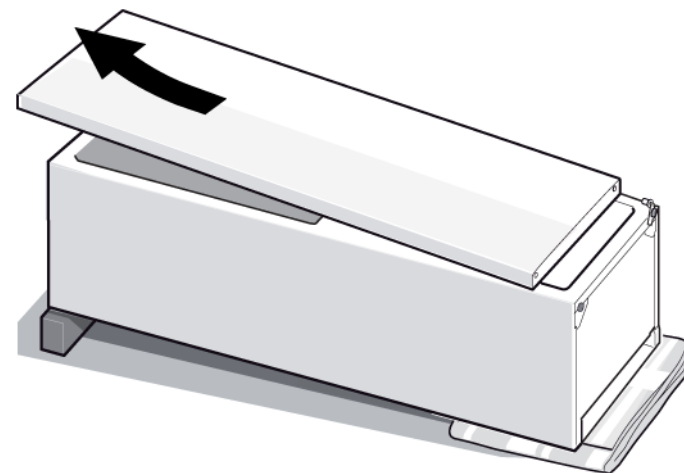

2.
  1. Odvijte vijak (1).
  2. Spodnji tečaj zavrtite navzven (2).
  3. Odstranite spodnji tečaj (3).

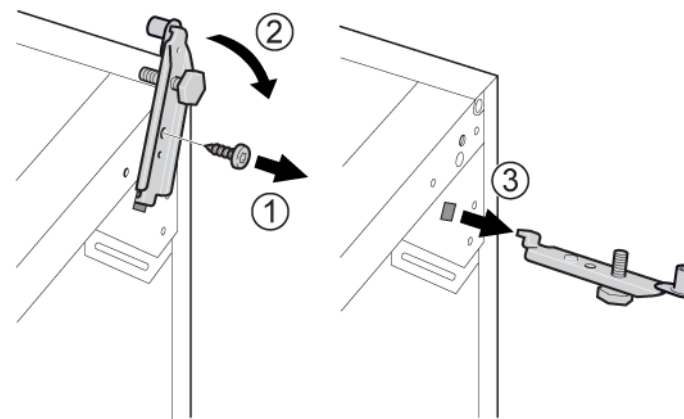

➡ Spodnji tečaj je odstranjen.

### 4.6.2 Namestitev spodnjega tečaja vrat

- ▶ Namestite v obratnem vrstnem redu.

## 4.7 Zamenjava police

### Zahteva:

- ✔ Vrata so odprta.

### 4.7.1 Odstranjevanje police

- ▶ Izvlecite polico.

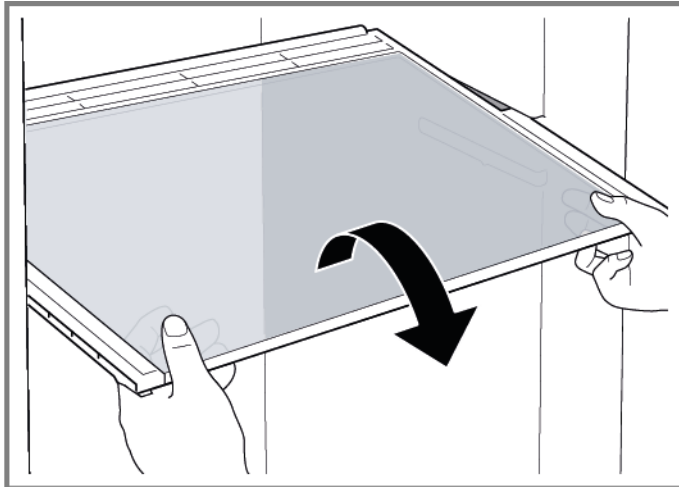

- ➡ Polica je odstranjena.

### 4.7.2 Namestitev police

- ▶ Namestite v obratnem vrstnem redu.



## 4.8 Zamenjava predala za zamrznjena živila

### Zahteva:

- ✔ Vrata so odprta.

### 4.8.1 Odstranjevanje predala za zamrznjena živila

- ▶ 1. Predal za zamrznjena živila izvlecite do konca (1).
- ▶ 2. Odstranite predal za zamrznjena živila (2).

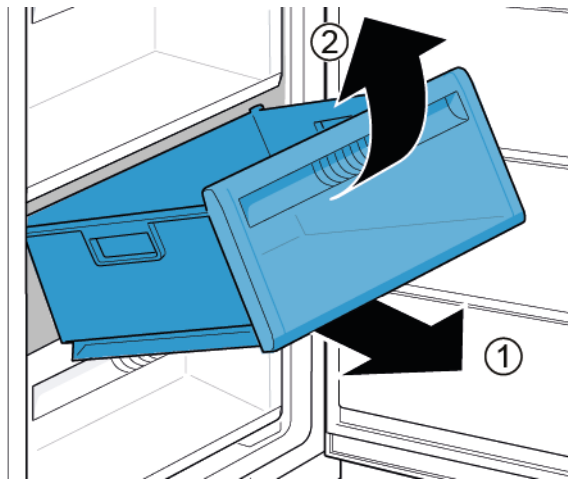

- ➡ Predal za zamrznjena živila je odstranjen.

### 4.8.2 Namestitev predala za zamrznjena živila

- ▶ Namestite v obratnem vrstnem redu.

## 4.9 Zamenjava ledomata

### Zahteva:

- ✔ Vrata so odprta.

### 4.9.1 Odstranjanje ledomata

- ▶ 1. Izvlecite predal za zamrznjena živila z ledomatom (1).
- ▶ 2. Sprostite zatiče (2).
- ▶ 3. Odstranite ledomat (3).

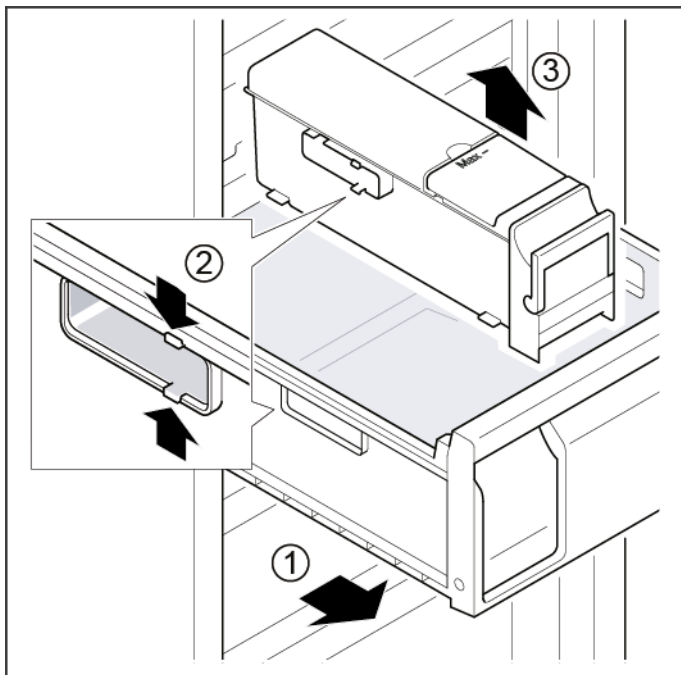

➡ Ledomat je odstranjen.

### 4.9.2 Namestitev ledomata

- ▶ Namestite v obratnem vrstnem redu.

## 4.10 Zamenjava zgornje lučke LED

### Posebna orodja:

🔗 Ploščati izvijač

Steblo 2,4 mm x 0,4 mm x 60 mm, v kompletu [00341820]



Vaš aparat je opremljen z osvetlitvijo LED, ki ne potrebuje vzdrževanja. To vrsto osvetlitve lahko popravi samo servisna služba ali pooblaščen strokovno osebje!



### ⚠️ NEVARNOST

#### Nevarnost električnega udara zaradi delov pod napetostjo!

Življenjska nevarnost zaradi električnega udara v primeru nepravilnega popravila

- ▶ Električne dele mora popraviti kvalificiran električar.
- ▶ Po popravilu je treba izvesti preizkus varnosti v skladu z VDE 0701 ali predpisi, ki veljajo za posamezno državo.



### ⚠️ NEVARNOST

#### Nevarnost električnega udara zaradi delov pod napetostjo!

Smrt zaradi električnega udara

- ▶ Izključite aparate iz električnega omrežja vsaj 60 sekund pred začetkom popravil.



### ⚠️ PREVIDNO

#### Ostri robovi!

Ureznine

- ▶ Uporabljajte zaščitne rokavice.

### Zahteva:

- ✔ Aparat je odklopljen iz omrežne napetosti.
- ✔ Vrata so odprta.
- ✔ Odstranjeni so zgornji notranji elementi aparata.

## 4.10.1 Odstranjevanje lučke LED

1. Lučko LED premaknite v levo.



- ➡ Električni priključek lučke LED je odklopljen.

2. Sprostite zatiče lučke LED.

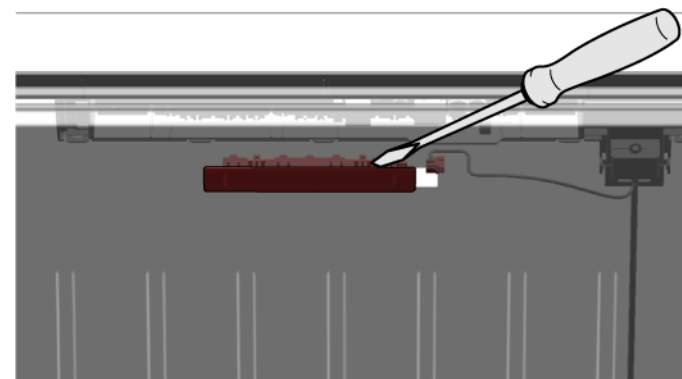

## Popravilo

3. Lučko LED premaknite naprej in jo odstranite.

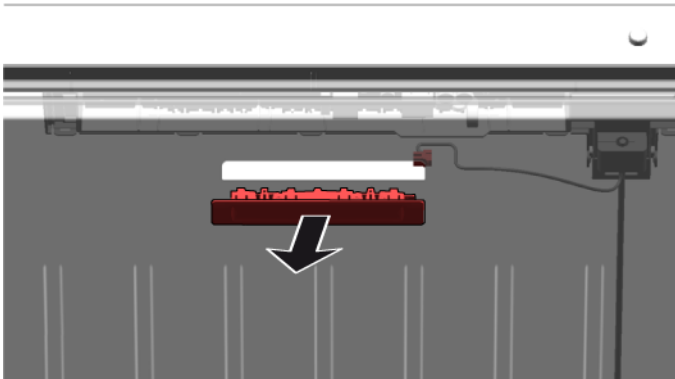

- ➡ Lučka LED je odstranjena.

### 4.10.2 Namestitev zgornje lučke LED

- ▶ Namestite v obratnem vrstnem redu.

# Consejos de reparación - Congelador

## En relación con este documento ..... 478

1.1	Información importante .....	478
1.1.1	Finalidad .....	478
1.2	Explicación de símbolos generales .....	478
1.2.1	Niveles de peligrosidad .....	478
1.2.2	Símbolos de peligro .....	478
1.2.3	Estructura de las advertencias .....	479
1.2.4	Símbolos generales .....	479

## Seguridad..... 480

2.1	Instrucciones generales de seguridad .....	480
2.1.1	Todos los aparatos electrodomésticos.....	480

## Herramientas y auxiliares ..... 481

## Reparación ..... 482

4.1	Sustituir la junta de la puerta .....	482
4.1.1	Retirar la junta de la puerta.....	482
4.1.2	Montar la junta de la puerta .....	482
4.2	Sustituir el tirador de la puerta.....	485
4.2.1	Retirar el tirador de la puerta .....	485
4.2.2	Montar el tirador de la puerta .....	485
4.3	Sustituir el tirador de apertura fácil (basculante) .....	486
4.3.1	Retirar el tirador de apertura fácil .....	486
4.3.2	Montar el tirador de apertura fácil.....	486
4.4	Sustituir la bisagra superior de la puerta .....	487
4.4.1	Desmontar la bisagra de la puerta.....	487
4.4.2	Montar la bisagra de la puerta.....	489
4.5	Sustituir la bisagra superior de la puerta (puerta con display) .....	490
4.5.1	Desmontar la bisagra de la puerta.....	491
4.5.2	Montar la bisagra de la puerta.....	492
4.6	Sustituir la bisagra inferior de la puerta .....	493
4.6.1	Sustituir la bisagra inferior de la puerta.....	493
4.6.2	Montar la bisagra inferior de la puerta .....	494
4.7	Sustituir el estante .....	495
4.7.1	Extraer el estante .....	495
4.7.2	Montar el estante .....	495

4.8	Sustituir el cajón de productos congelados .....	496
4.8.1	Extraer el cajón de productos congelados.....	496
4.8.2	Montar el cajón de productos congelados .....	496
4.9	Sustituir el fabricante de hielo .....	497
4.9.1	Extraer el fabricante de hielo.....	497
4.9.2	Montar el fabricante de hielo .....	497
4.10	Sustituir la iluminación LED superior .....	498
4.10.1	Desmontar la iluminación LED .....	498
4.10.2	Montar la iluminación LED superior .....	499

# **i** En relación con este documento

## 1.1 Información importante

### 1.1.1 Finalidad

Estas indicaciones de reparación sirven como ayuda al consumidor para reparar aparatos por su cuenta conforme al reglamento aplicable sobre diseño ecológico (a partir de 03/2021).

Contienen información sobre cómo sustituir repuestos determinados e incluye las advertencias y los riesgos.

En caso de dudas, póngase en contacto con nuestro departamento de atención al cliente. Solo asumiremos la responsabilidad por daños si las indicaciones de reparación se han seguido correctamente.

## 1.2 Explicación de símbolos generales

### 1.2.1 Niveles de peligrosidad

Los niveles de peligro consisten en un símbolo y una palabra de advertencia. La palabra de advertencia identifica la gravedad del peligro.







Nivel de peligro	Significado
 <b>PELIGRO</b>	Si no se tiene en cuenta la advertencia, ocasionará la muerte o lesiones graves.
 <b>ADVERTENCIA</b>	Si no se tiene en cuenta la advertencia, puede ocasionar la muerte o lesiones graves.
 <b>PRECAUCIÓN</b>	Si no se tiene en cuenta la advertencia, puede ocasionar lesiones de carácter leve.
<b>ATENCION</b>	Si no se tiene en cuenta la advertencia, puede ocasionar daños materiales.

Tabla 1: Niveles de peligrosidad

### 1.2.2 Símbolos de peligro

Los símbolos de peligro son una representación simbólica que indica el tipo de peligrosidad.

En este documento se utilizan los siguientes símbolos de peligro:

Símbolo de peligro	Significado
	Advertencia general
	Peligro de lesiones por corriente eléctrica
	Riesgo de explosión
	Peligro de lesiones a causa de cortes

## **i** En relación con este documento





Símbolo de peligro	Significado
	Peligro de lesiones por aplastamiento
	Peligro de lesiones por superficies calientes
	Peligro a causa de campos magnéticos de gran potencia
	Peligro derivado de radiación no ionizante

Tabla 2: Símbolos de peligro

### 1.2.3 Estructura de las advertencias

Las advertencias de este documento tienen una apariencia y una estructura uniformes.

	<p><b>⚠ PELIGRO</b></p> <p><b>¡Tipo y fuente del peligro!</b> Posibles consecuencias de ignorar el peligro / la advertencia.</p> <ul style="list-style-type: none"> <li>▶ Medidas y prohibiciones para prevenir el peligro.</li> </ul>
--	--

El ejemplo siguiente muestra una advertencia de descarga eléctrica a causa de piezas o partes cargadas con tensión. Se menciona la medida para evitar el peligro.

	<p><b>⚠ PELIGRO</b></p> <p><b>¡Riesgo de descarga eléctrica debido a partes con tensión!</b> Muerte por electrocución</p> <ul style="list-style-type: none"> <li>▶ Desconectar el aparato de la red al menos 60 segundos antes de comenzar con la reparación.</li> </ul>
--	--

### 1.2.4 Símbolos generales

En este documento se utilizan los siguientes símbolos generales:

Símbolo general	Significado
	Identificación de una indicación especial (texto y/o gráfico)







Símbolo general	Significado
	Identificación de un consejo simple (solo texto)
	Identificación de un enlace a un video tutorial
	Identificación de una herramienta requerida
	Identificación de una condición previa (prerrequisito)
	Identificación de una condición (si ..., entonces ...)
	Identificación de un resultado
Iniciar	Identificación de una tecla o botón
[00123456]	Identificación de un número de material
Estado	Identificación del texto / ventana mostrado (en el display del aparato)

Tabla 3: Símbolos generales

## 2.1 Instrucciones generales de seguridad

### 2.1.1 Todos los aparatos electrodomésticos

#### ¡Riesgo de descarga eléctrica debido a piezas con tensión!

- ¡Los errores en las reparaciones que incluyan componentes eléctricos pueden provocar una descarga eléctrica!
- Desconectar el aparato de la red durante al menos 60 segundos antes de comenzar con el trabajo.
- Después de la reparación, encargar una prueba de seguridad conforme a VDE 0701 o los reglamentos específicos del país.

#### ¡Riesgo de lesiones debido a bordes afilados!

- Usar guantes de protección.

#### Riesgo de aplastamiento durante la reparación, mantenimiento, resolución de problemas y servicio debido a componentes pesados y móviles

- Usar calzado de seguridad.
- Asegure los componentes pesados para que no se caigan.
- No pegue partes del cuerpo en componentes móviles.

#### ¡Riesgo para la seguridad/el funcionamiento del aparato!



- Utilizar únicamente los repuestos originales.

#### ¡Riesgo de daños de los componentes sensibles a cargas electrostáticas (ESD)!

- No tocar los módulos, incluidas las conexiones y las pistas conductoras.



## Herramientas y auxiliares

Designacion	Detalles	Imágenes
Paño de protección [00342013]	60 cm x 50 cm	
Destornillador Phi-llips PH2		
Punta Torx TX20 [00340865]	6,3 mm (1/4")	
Destornillador plano	Punta 2,4 mm x 0,4 mm x 60 mm, en el kit [00341820]	

## 4.1 Sustituir la junta de la puerta

### Requisito:

- ✔ La puerta está abierta.

### 4.1.1 Retirar la junta de la puerta

1. Soltar la junta de la puerta de la ranura por las esquinas izquierda y derecha.

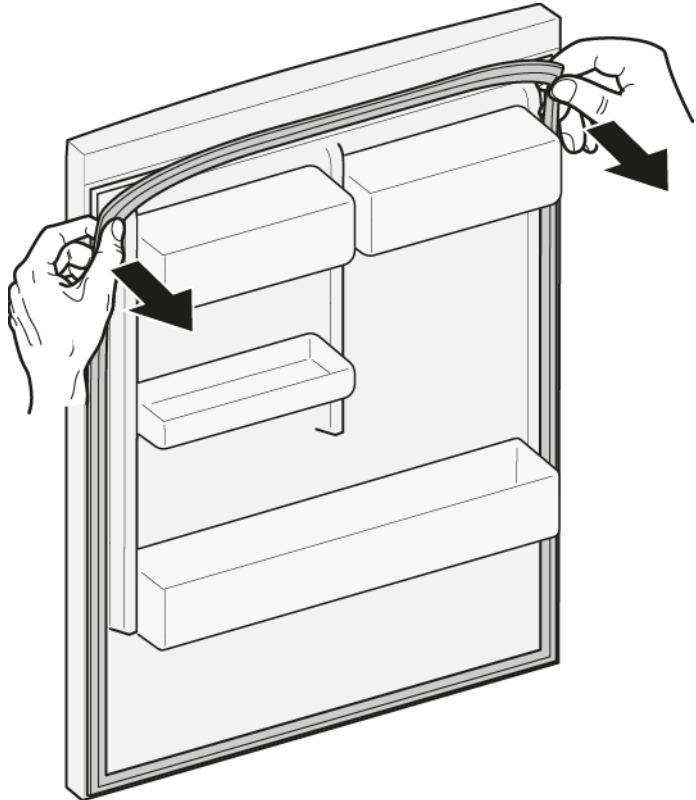

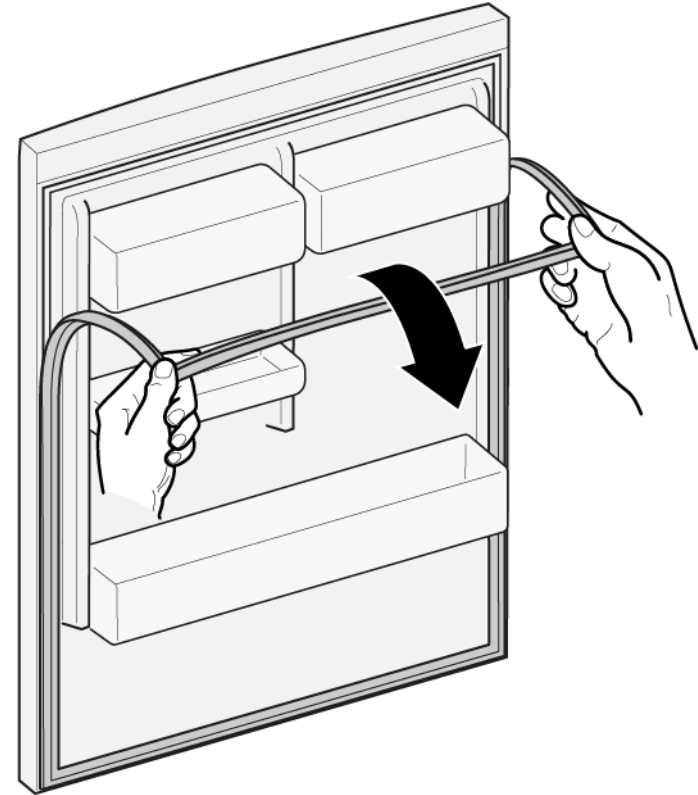

2. Sacar la junta de la puerta de la ranura.



- ➡ Se ha retirado la junta de la puerta.

### 4.1.2 Montar la junta de la puerta

	El grosor de la nueva junta de la puerta puede diferir ligeramente del grosor de la junta usada. Esto no afectará al comportamiento de cierre ni al funcionamiento a largo plazo.
	Si su aparato tienen bisagras ajustables o accesorios de bisagra, puede optimizar el comportamiento de cierre.
	Los pequeños agujeros laterales de la junta de la puerta son funcionales (necesarios para la ventilación). No se trata de un fallo de producción.

## Reparación

1. Comprobar si la ranura de la junta presenta daños.

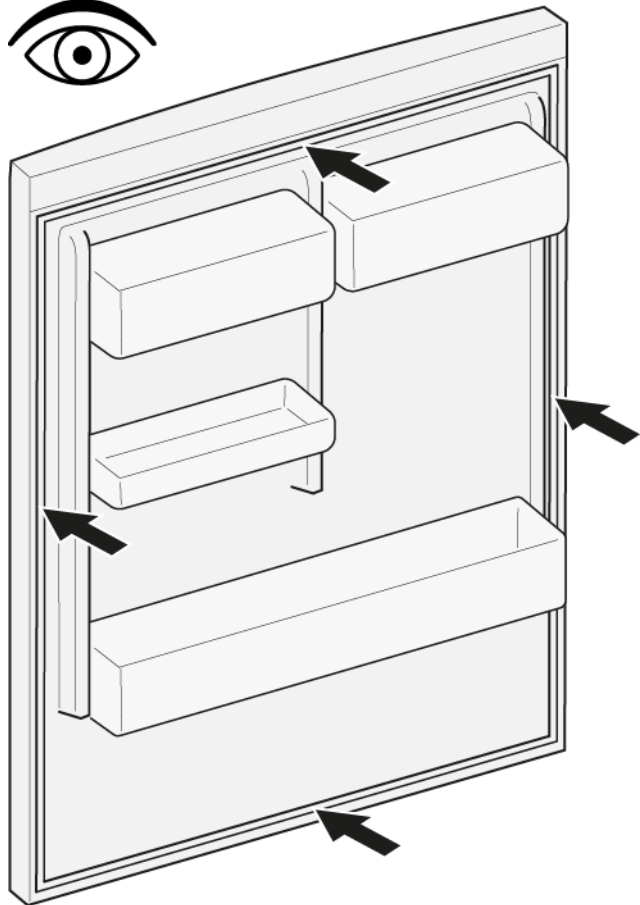

4. Presionar las esquinas de la junta en la parte superior y la inferior de la ranura.

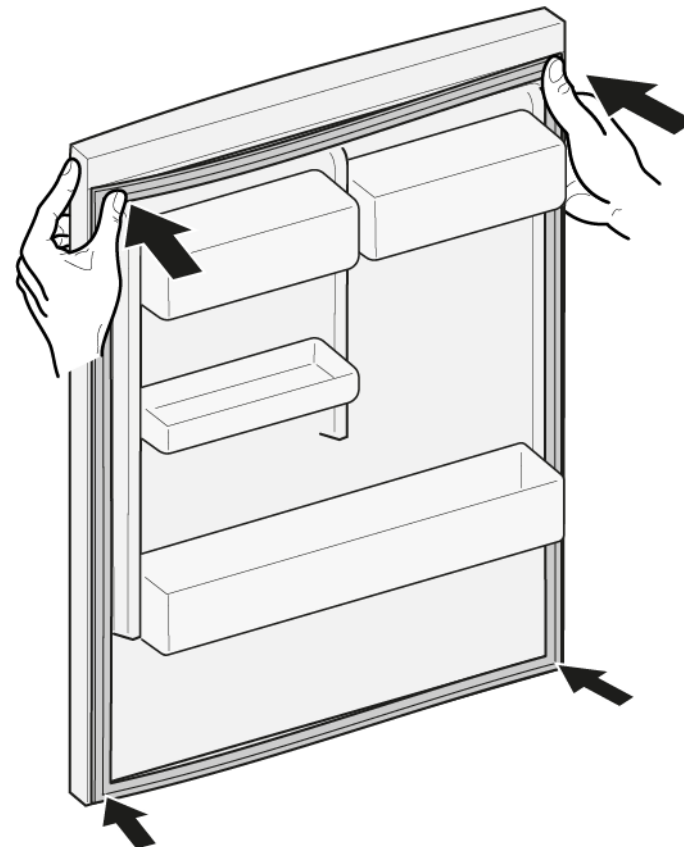

2.  Si la ranura de la junta está dañada.
  - Contactar con el servicio de atención al cliente.

3. 

	Una ligera deformación de la junta de la puerta es normal y no afecta a su función. Se recomienda alisar la junta de la puerta antes de insertarla en el aparato.
---	---

Calentar ligeramente la junta de la puerta con un secador de pelo o agua caliente y volver a darle forma con las manos.

## Reparación

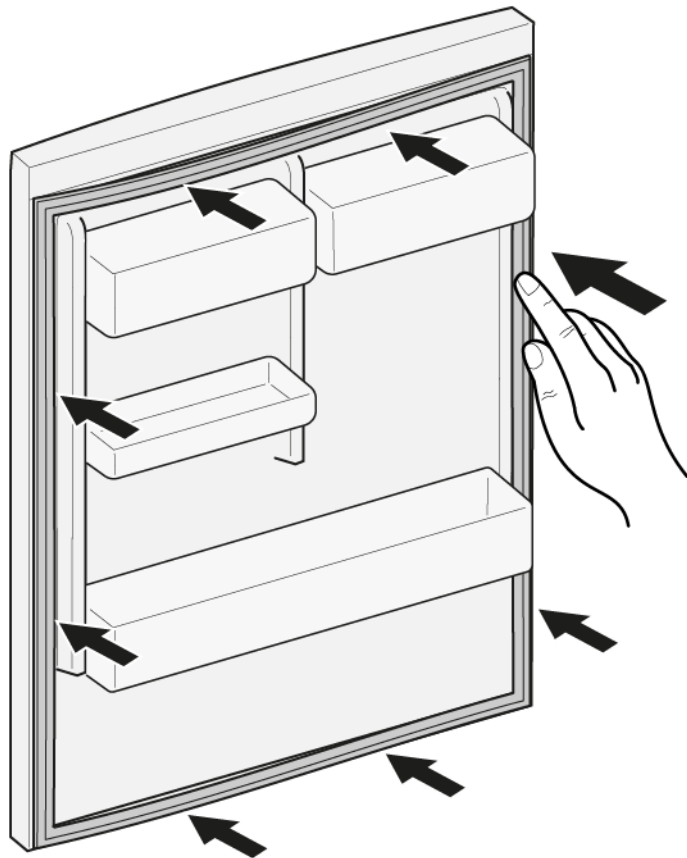

5. Presionar metiendo toda la junta paso a paso en la ranura.





-  La junta de la puerta está montada.

## 4.2 Sustituir el tirador de la puerta

### Herramientas necesarias:

-  Punta Torx TX20                      6,3 mm (1/4")                      [00340865]
-  Destornillador plano                      Punta 10 mm x 1,6 mm x 200 mm

### Requisito:

-  El aparato está desconectado del suministro eléctrico.
-  La puerta está abierta.

### 4.2.1 Retirar el tirador de la puerta

- ▶ 1. Retirar las tapas de los dos tornillos (1).
- ▶ 2. Desatornillar los dos tornillos (2).
- ▶ 3. Retirar el tirador de la puerta (3).

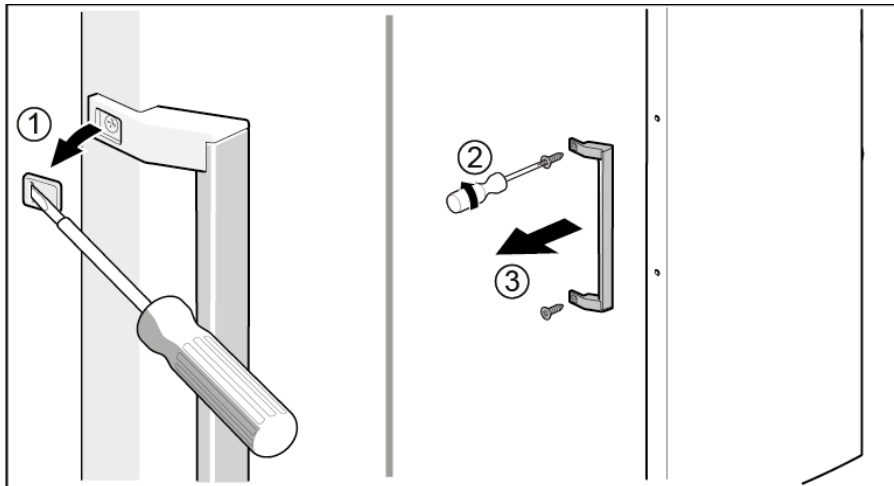

 Se ha retirado el tirador de la puerta.

### 4.2.2 Montar el tirador de la puerta

- ▶ Montar en orden inverso.

## 4.3 Sustituir el tirador de apertura fácil (basculante)

### Herramientas necesarias:

- 🔧 Destornillador Phillips PH2

### Requisito:

- ✅ El aparato está desconectado del suministro eléctrico.
- ✅ La puerta está abierta.

### 4.3.1 Retirar el tirador de apertura fácil

- ▶ 1. Retirar la cubierta del tirador de apertura fácil (1).
- ▶ 2. Desatornillar los dos tornillos (2).

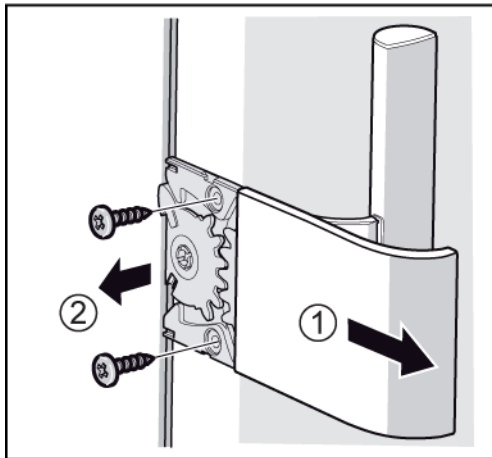

- ➡ El tirador de apertura fácil se ha retirado.

## 4.3.2 Montar el tirador de apertura fácil

Antes del montaje, se debe ajustar correctamente el mecanismo «easy opening handle».

En el gráfico se muestra la colocación correcta de la leva de empuje (1), las ruedas dentadas (2) y (3), el muelle (4) y el tope (5) para la instalación de la puerta en el lado izquierdo.

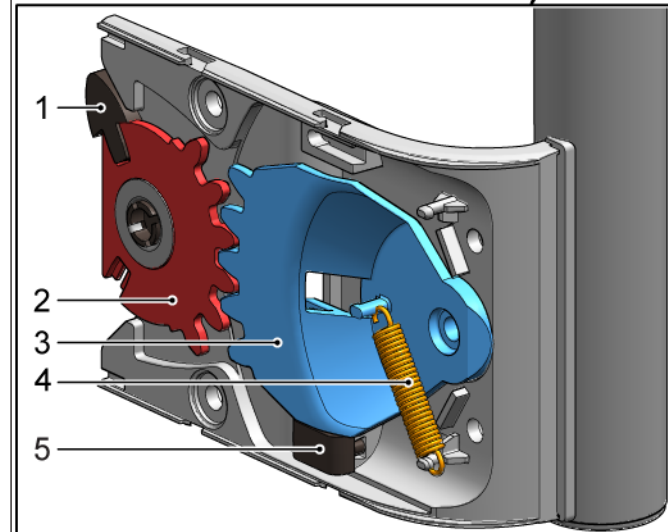
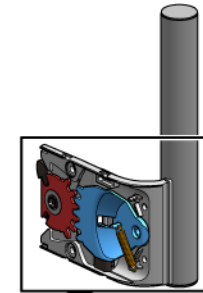



La colocación de los subcomponentes del mecanismo «easy opening handle» para la instalación de la puerta en el lado derecho se describe en el documento de instrucciones de montaje.

- ▶ Montar en orden inverso.

## 4.4 Sustituir la bisagra superior de la puerta

### Herramientas necesarias:

 Punta Torx TX20      6,3 mm (1/4")      [00340865]

	<p><b>⚠ ADVERTENCIA</b></p> <p><b>¡Aparatos pesados y voluminosos!</b> Espalda y lesiones musculares</p> <ul style="list-style-type: none"><li>▶ La operación de extraer la puerta del aparato solo deben llevarla a cabo especialistas formados.</li><li>▶ Para mover el aparato se necesitan dos personas.</li><li>▶ Utilizar únicamente herramientas y equipos apropiados.</li></ul>
	<p><b>⚠ PRECAUCIÓN</b></p> <p><b>¡Bordes o cantos cortantes!</b> Peligro de cortes</p> <ul style="list-style-type: none"><li>▶ Usar guantes de seguridad.</li></ul>
	<p><b>⚠ ADVERTENCIA</b></p> <p><b>¡Deslizamiento de aparatos inclinados!</b> Fracturas óseas / lesiones por aplastamiento</p> <ul style="list-style-type: none"><li>▶ Asegurar los electrodomésticos contra deslizamientos.</li></ul>
	<p><b>⚠ PRECAUCIÓN</b></p> <p><b>¡Riesgo de que se caigan piezas debido a los tornillos aflojados!</b> Peligro de lesiones debido a piezas que caigan.</p> <ul style="list-style-type: none"><li>▶ Asegure el componente para que no se caiga.</li></ul>
	<p><b>⚠ ATENCION</b></p> <p><b>¡Riesgo de que se caigan piezas debido a los tornillos aflojados!</b> Daños en otras partes del aparato o en el domicilio del consumidor, p. ej., en la parte inferior.</p> <ul style="list-style-type: none"><li>▶ Asegure el componente para que no se caiga.</li></ul>

### Requisito:

- ✔ El aparato está desconectado del suministro eléctrico.
- ✔ Se han retirado los accesorios del interior del aparato.

## 4.4.1 Desmontar la bisagra de la puerta

## 🔧 Reparación

1. Colocar el aparato sobre su lado posterior.

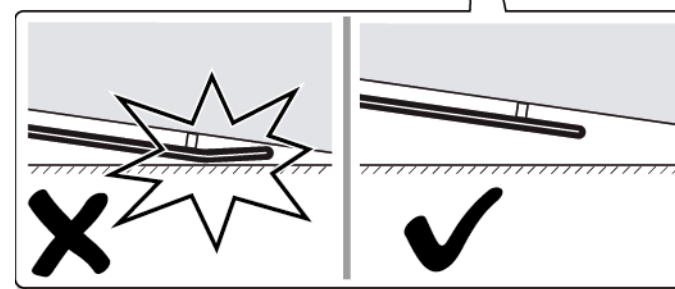
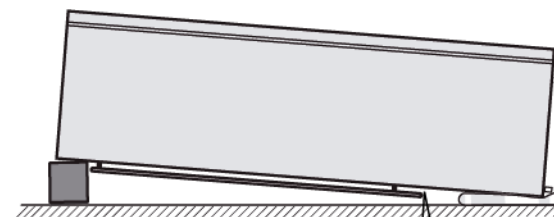
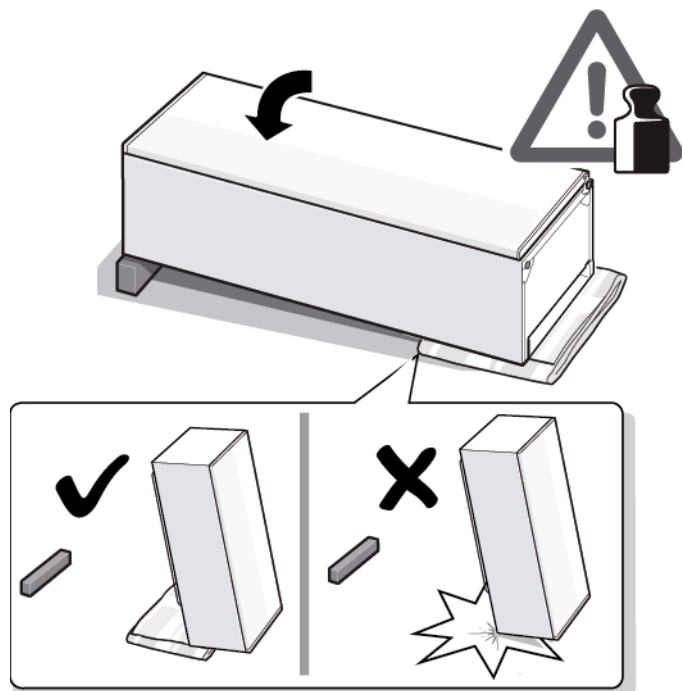

2. 1. Presionar la tapa de la bisagra superior en ambos lados (1).  
2. Sacar la tapa de la bisagra superior (2).  
3. Retirar la tapa de la bisagra superior (3).

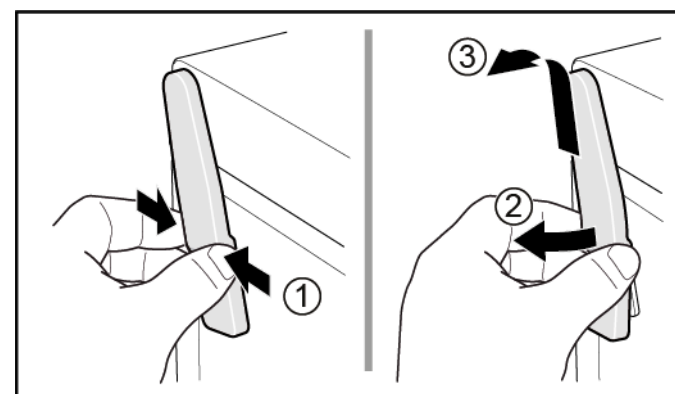



## Reparación

3. 1. Desatornillar los dos tornillos (1).
2. Retirar la bisagra superior (2).

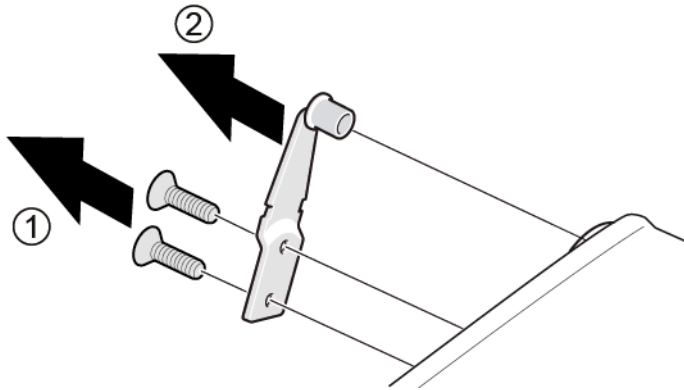

 Se ha retirado la bisagra superior de la puerta.

### 4.4.2 Montar la bisagra de la puerta

- ▶ Montar en orden inverso.

## 4.5 Sustituir la bisagra superior de la puerta (puerta con display)

### Herramientas necesarias:

 Punta Torx TX20      6,3 mm (1/4")      [00340865]

	<b>⚠ ADVERTENCIA</b>
	<p><b>¡Aparatos pesados y voluminosos!</b> Espalda y lesiones musculares</p> <ul style="list-style-type: none"> <li>▶ La operación de extraer la puerta del aparato solo deben llevarla a cabo especialistas formados.</li> <li>▶ Para mover el aparato se necesitan dos personas.</li> <li>▶ Utilizar únicamente herramientas y equipos apropiados.</li> </ul>

	<b>⚠ PRECAUCIÓN</b>
	<p><b>¡Bordes o cantos cortantes!</b> Peligro de cortes</p> <ul style="list-style-type: none"> <li>▶ Usar guantes de seguridad.</li> </ul>

	<b>⚠ ADVERTENCIA</b>
	<p><b>¡Deslizamiento de aparatos inclinados!</b> Fracturas óseas / lesiones por aplastamiento</p> <ul style="list-style-type: none"> <li>▶ Asegurar los electrodomésticos contra deslizamientos.</li> </ul>



	<b>⚠ PRECAUCIÓN</b>
	<p><b>¡Riesgo de que se caigan piezas debido a los tornillos aflojados!</b> Peligro de lesiones debido a piezas que caigan.</p> <ul style="list-style-type: none"> <li>▶ Asegure el componente para que no se caiga.</li> </ul>

	<b>ATENCIÓN</b>
	<p><b>¡Riesgo de que se caigan piezas debido a los tornillos aflojados!</b> Daños en otras partes del aparato o en el domicilio del consumidor, p. ej., en la parte inferior.</p> <ul style="list-style-type: none"> <li>▶ Asegure el componente para que no se caiga.</li> </ul>

	<b>⚠ PELIGRO</b>
	<p><b>¡Riesgo de descarga eléctrica debido a piezas con tensión!</b> Peligro mortal por descarga eléctrica en caso de reparación inadecuada</p> <ul style="list-style-type: none"> <li>▶ Las piezas eléctricas deberían ser reparadas por electricistas cualificados.</li> <li>▶ Después de la reparación, encargar una prueba de seguridad conforme a VDE 0701 o los reglamentos específicos del país.</li> </ul>

	<b>⚠ PELIGRO</b>
	<p><b>¡Riesgo de descarga eléctrica debido a partes con tensión!</b> Muerte por electrocución</p> <ul style="list-style-type: none"> <li>▶ Desconectar el aparato de la red al menos 60 segundos antes de comenzar con la reparación.</li> </ul>

### Requisito:

-  El aparato está desconectado del suministro eléctrico.
-  Se han retirado los accesorios del interior del aparato.

## 4.5.1 Desmontar la bisagra de la puerta

1. Colocar el aparato sobre su lado posterior.

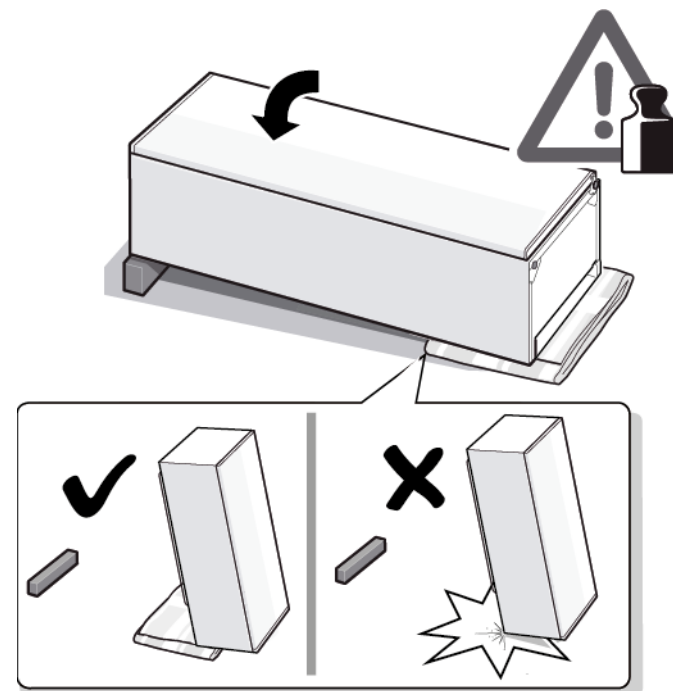

## Reparación

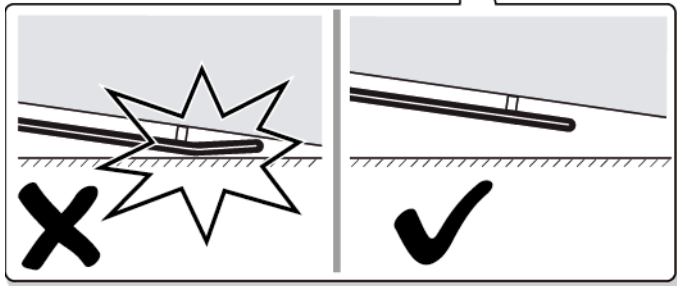
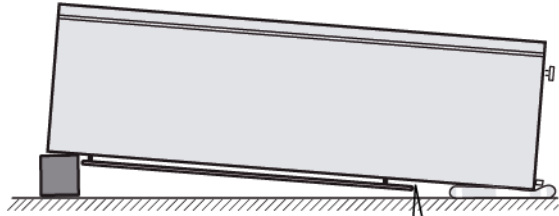

1. Presionar la tapa de la bisagra superior en ambos lados (1).
2. Sacar la tapa de la bisagra superior (2).
3. Retirar la tapa de la bisagra superior (3).

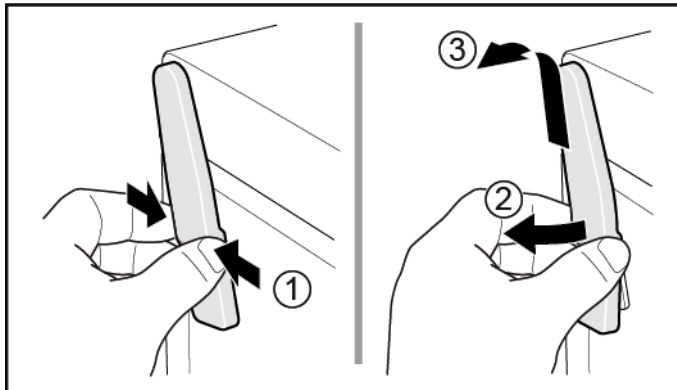

1. Retirar la tapa de la caja de cables (1).
2. Retirar la protección de cables (2).
3. Desconectar la conexión eléctrica (3).
4. Desatornillar los dos tornillos (4).
5. Retirar la bisagra superior (5).

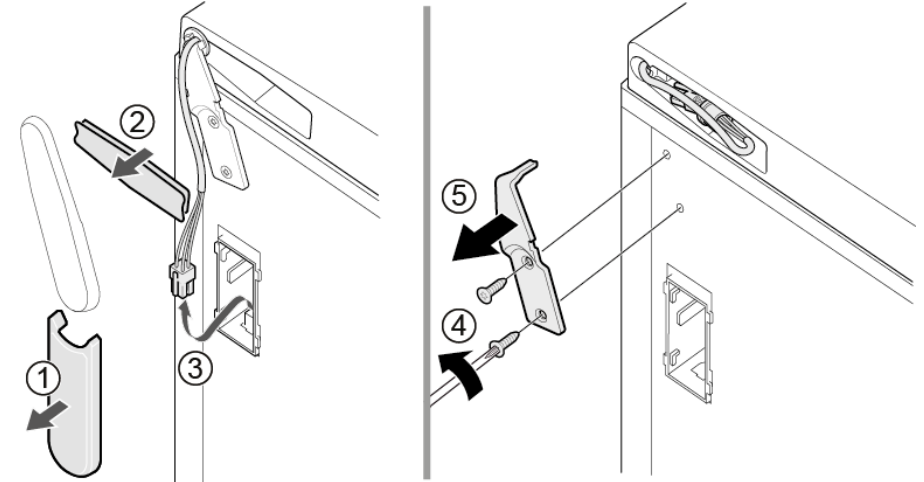

➡ Se ha retirado la bisagra superior de la puerta.

### 4.5.2 Montar la bisagra de la puerta

- ▶ Montar en orden inverso.

## 4.6 Sustituir la bisagra inferior de la puerta

### Herramientas necesarias:

🔧 Punta Torx TX20      6,3 mm (1/4")      [00340865]

	<b>⚠️ ADVERTENCIA</b>
	<p><b>¡Aparatos pesados y voluminosos!</b> Espalda y lesiones musculares</p> <ul style="list-style-type: none"> <li>▶ La operación de extraer la puerta del aparato solo deben llevarla a cabo especialistas formados.</li> <li>▶ Para mover el aparato se necesitan dos personas.</li> <li>▶ Utilizar únicamente herramientas y equipos apropiados.</li> </ul>

	<b>⚠️ PRECAUCIÓN</b>
	<p><b>¡Bordes o cantos cortantes!</b> Peligro de cortes</p> <ul style="list-style-type: none"> <li>▶ Usar guantes de seguridad.</li> </ul>

	<b>⚠️ ADVERTENCIA</b>
	<p><b>¡Deslizamiento de aparatos inclinados!</b> Fracturas óseas / lesiones por aplastamiento</p> <ul style="list-style-type: none"> <li>▶ Asegurar los electrodomésticos contra deslizamientos.</li> </ul>

	<b>⚠️ PRECAUCIÓN</b>
	<p><b>¡Riesgo de que se caigan piezas debido a los tornillos aflojados!</b> Peligro de lesiones debido a piezas que caigan.</p> <ul style="list-style-type: none"> <li>▶ Asegure el componente para que no se caiga.</li> </ul>

	<b>ATENCIÓN</b>
	<p><b>¡Riesgo de que se caigan piezas debido a los tornillos aflojados!</b> Daños en otras partes del aparato o en el domicilio del consumidor, p. ej., en la parte inferior.</p> <ul style="list-style-type: none"> <li>▶ Asegure el componente para que no se caiga.</li> </ul>

### Requisito:

- ✔ El aparato está desconectado del suministro eléctrico.
- ✔ Se han retirado los accesorios del interior del aparato.
- ✔ Se ha colocado el aparato sobre el lado posterior.

✔ [Se ha retirado la bisagra superior. →490](#)

### 4.6.1 Sustituir la bisagra inferior de la puerta

1. Retirar la puerta.

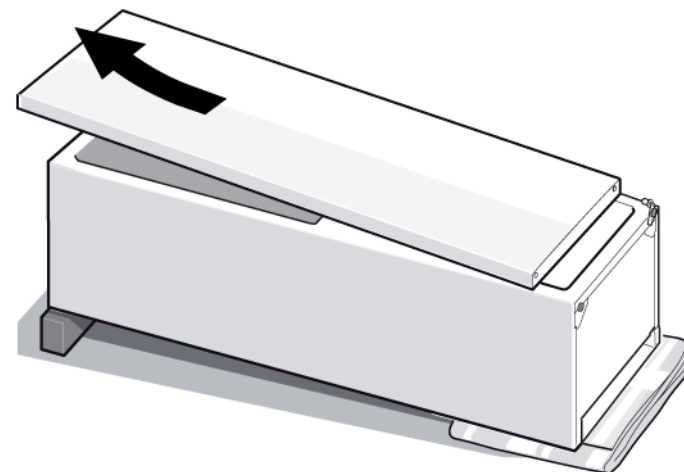

2.
  1. Desatornillar el tornillo (1).
  2. Girar la bisagra inferior hacia fuera (2).
  3. Retirar la bisagra inferior (3).

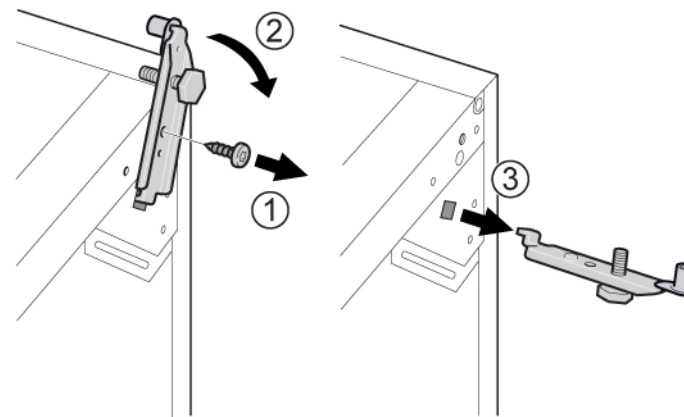

➡ Se ha retirado la bisagra inferior.

### 4.6.2 Montar la bisagra inferior de la puerta

- ▶ Montar en orden inverso.

## 4.7 Sustituir el estante

### Requisito:

- ✔ La puerta está abierta.

### 4.7.1 Extraer el estante

- ▶ Sacar el estante.

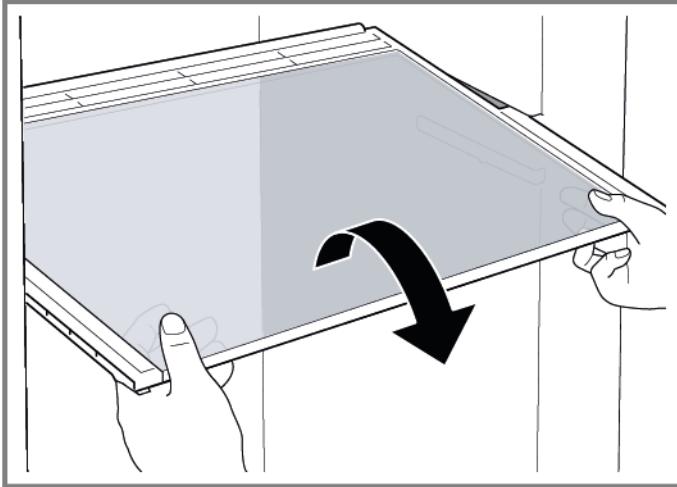

➡ Se ha retirado el estante.

### 4.7.2 Montar el estante

- ▶ Montar en orden inverso.

## 4.8 Sustituir el cajón de productos congelados

### Requisito:

- ✔ La puerta está abierta.

### 4.8.1 Extraer el cajón de productos congelados

- ▶ 1. Sacar por completo el cajón de productos congelados (1).
- ▶ 2. Extraer el cajón de productos congelados (2).

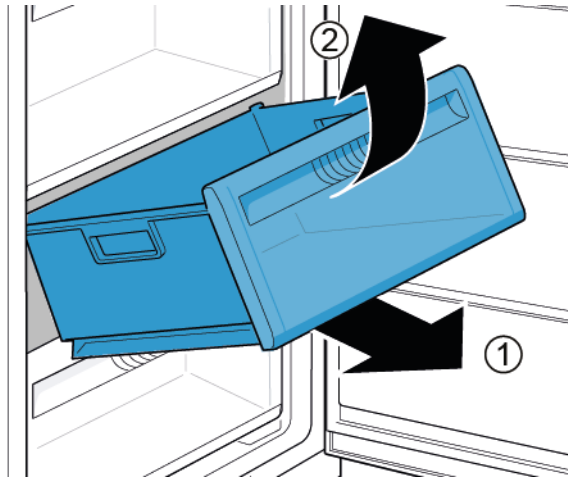

- ➡ Se ha retirado el cajón de productos congelados.

### 4.8.2 Montar el cajón de productos congelados

- ▶ Montar en orden inverso.



## 4.9 Sustituir el fabricante de hielo

### Requisito:

- ✔ La puerta está abierta.

### 4.9.1 Extraer el fabricante de hielo

- ▶ 1. Sacar el estante del cajón de productos congelados con el fabricante de hielo (1).
- ▶ 2. Soltar los ganchos (2).
- ▶ 3. Retirar el fabricante de hielo (3).

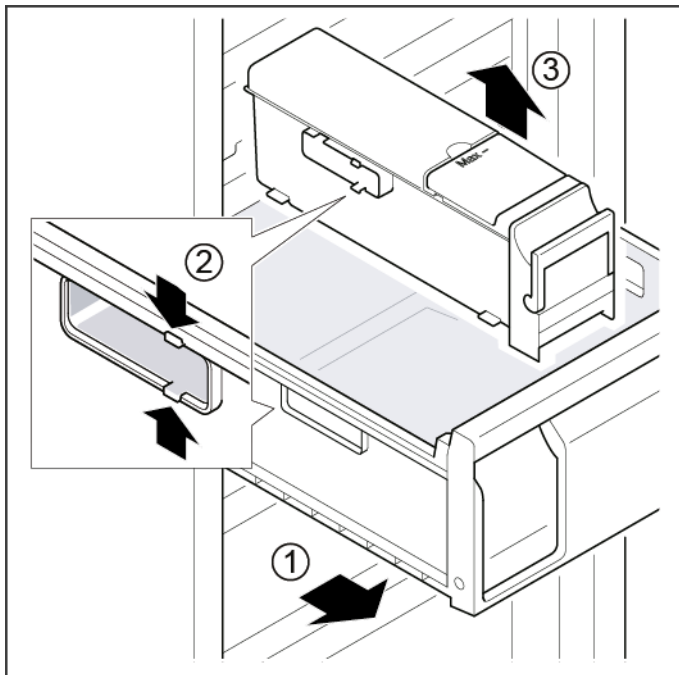

➡ Se ha retirado el fabricante de hielo.

### 4.9.2 Montar el fabricante de hielo

- ▶ Montar en orden inverso.

## 4.10 Sustituir la iluminación LED superior

### Herramientas necesarias:

- Destornillador plano Punta 2,4 mm x 0,4 mm x 60 mm, en el kit [00341820]



Su aparato cuenta con una iluminación LED exenta de mantenimiento. ¡Solo el servicio de atención al cliente o los técnicos autorizados pueden reparar esta iluminación!



### PELIGRO

#### ¡Riesgo de descarga eléctrica debido a piezas con tensión!

Peligro mortal por descarga eléctrica en caso de reparación inadecuada

- Las piezas eléctricas deberían ser reparadas por electricistas cualificados.
- Después de la reparación, encargar una prueba de seguridad conforme a VDE 0701 o los reglamentos específicos del país.



### PELIGRO

#### ¡Riesgo de descarga eléctrica debido a partes con tensión!

Muerte por electrocución

- Desconectar el aparato de la red al menos 60 segundos antes de comenzar con la reparación.



### PRECAUCIÓN

#### ¡Bordes o cantos cortantes!

Peligro de cortes

- Usar guantes de seguridad.

### Requisito:

- El aparato está desconectado del suministro eléctrico.
- La puerta está abierta.
- Se han retirado los accesorios superiores del interior.

### 4.10.1 Desmontar la iluminación LED

- Mover la iluminación LED hacia el lado izquierdo.

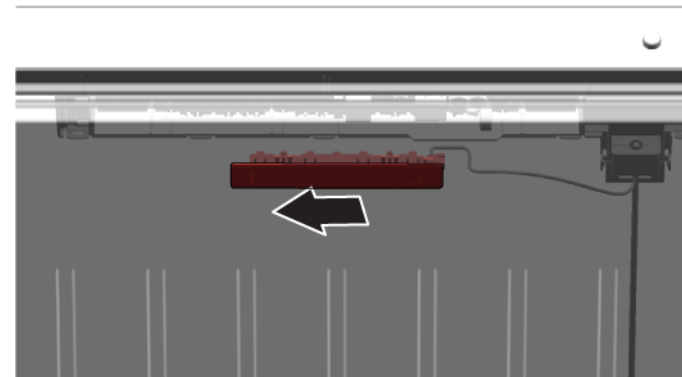

- Se ha desconectado la conexión eléctrica de la iluminación LED.

- Soltar los ganchos de la iluminación LED.

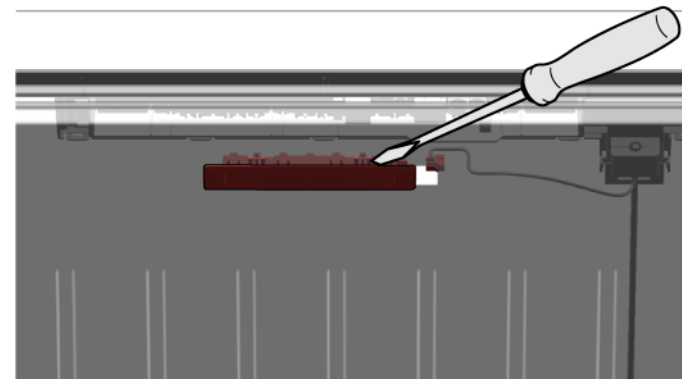

## Reparación

3. Retirar la iluminación LED moviéndola hacia delante.

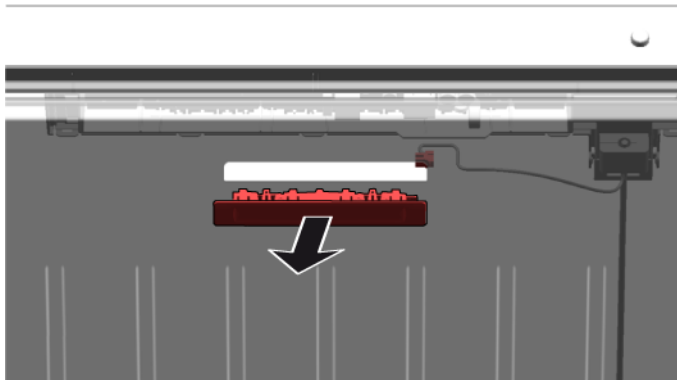

-  Se ha retirado la iluminación LED.

### 4.10.2 Montar la iluminación LED superior

- ▶ Montar en orden inverso.

# Reparationsinformation - Frysskåp

 <b>Om detta dokument</b> .....	<b>501</b>
1.1 Viktig information.....	501
1.1.1 Syfte .....	501
1.2 Symbolförklaringar.....	501
1.2.1 Faronivåer.....	501
1.2.2 Risksymboler.....	501
1.2.3 Varningarnas struktur.....	502
1.2.4 Allmänna symboler.....	502
 <b>Säkerhet</b> .....	<b>503</b>
2.1 Allmänna säkerhetsanvisningar.....	503
2.1.1 Alla hushållsmaskiner.....	503
 <b>Verktyg och hjälpmedel</b> .....	<b>504</b>
 <b>Reparation</b> .....	<b>505</b>
4.1 Byta dörrpackning.....	505
4.1.1 Ta bort dörrpackning .....	505
4.1.2 Montera dörrpackning .....	505
4.2 Byta dörrhandtag.....	508
4.2.1 Ta bort dörrhandtag .....	508
4.2.2 Montera dörrhandtag.....	508
4.3 Byta Easy opening handle.....	509
4.3.1 Ta bort Easy opening handle .....	509
4.3.2 Montera Easy opening handle.....	509
4.4 Byta dörrens övre gångjärn .....	510
4.4.1 Ta bort dörrens gångjärn .....	510
4.4.2 Montera dörrens gångjärn .....	512
4.5 Byta dörrens övre gångjärn (dörr med display).....	513
4.5.1 Ta bort dörrens gångjärn .....	514
4.5.2 Montera dörrens gångjärn .....	515
4.6 Byta dörrens nedre gångjärn .....	516
4.6.1 Byta dörrens nedre gångjärn.....	516
4.6.2 Montera dörrens nedre gångjärn .....	516
4.7 Byta hylla .....	517
4.7.1 Ta bort hylla.....	517
4.7.2 Montera hylla.....	517

4.8 Byta fack för frysta matvaror .....	518
4.8.1 Ta bort fack för frysta matvaror.....	518
4.8.2 Montera fack för frysta matvaror .....	518
4.9 Byta ismaskin .....	519
4.9.1 Ta bort ismaskin .....	519
4.9.2 Montera ismaskin .....	519
4.10 Byta översta LED-lampan.....	520
4.10.1 Ta bort LED-lampan .....	520
4.10.2 Montera översta LED-lampan.....	521

# **i** Om detta dokument

## 1.1 Viktig information

### 1.1.1 Syfte

Dessa reparationstips hjälper kunden att själv reparera maskiner enligt gällande ekodesignbestämmelser (som gäller 03/2021).





De innehåller information om hur vissa reservdelar ska bytas samt tillhörande varningar och risker.

Kontakta vår kundtjänst om du har frågor. Vi åtar oss bara ansvar för skador om reparationstipsen har följts korrekt.

## 1.2 Symbolförklaringar

### 1.2.1 Faronivåer

Varningsnivåerna består av en symbol och ett signalord. Signalordet visar hur allvarlig faran är.





Varningsnivå	Innebörd
	Om inte varningsmeddelandet följs kommer det att leda till dödsfall eller allvarliga personskador.
	Om inte varningsmeddelandet följs kan det leda till dödsfall eller allvarliga personskador.
	Om inte varningsmeddelandet följs kan det leda till lättare personskador.
	Om inte varningsmeddelandet följs kan det leda till materialskador.

Grafik 1: Faronivåer



### 1.2.2 Risksymboler

Risksymboler är symboler som visar typen av fara.

Följande risksymboler används i detta dokument:

Risksymbol	Innebörd
	Allmänt varningsmeddelande
	Fara på grund av elektrisk spänning
	Explosionsrisk
	Fara för skärskador
	Fara för krosskador



## i Om detta dokument

Risksymbol	Innebörd
	Fara på grund av heta ytor
	Fara på grund av starka magnetfält
	Fara på grund av icke-joniserande strålning

Grafik 2: Risksymboler

### 1.2.3 Varningarnas struktur

Varningar i detta dokument har ett standardiserat utseende och en standardiserad struktur.



	<p> <b>FARA!</b></p> <p><b>Farans typ och ursprung!</b> Möjliga konsekvenser av att faran/varningen ignoreras.</p> <ul style="list-style-type: none"> <li>▶ Åtgärder och förbud för att förebygga faran.</li> </ul>
--	--





Följande exempel visar en varning som varnar för elstötar från strömförande delar. Det står vilken åtgärd som förebygger faran.

	<p> <b>FARA!</b></p> <p><b>Risk för elstötar på grund av strömförande delar!</b> Dödsfall på grund av elstötar</p> <ul style="list-style-type: none"> <li>▶ Koppla bort maskiner från elförsörjningen minst 60 sekunder innan reparationer påbörjas.</li> </ul>
---	---

### 1.2.4 Allmänna symboler

Följande allmänna symboler används i detta dokument:

Allm. symbol	Innebörd
	Identifiering av ett särskilt tips (text och/eller bild)
	Identifiering av ett enkelt tips (endast text)

Allm. symbol	Innebörd
	Identifiering av en länk till en videohandledning
	Identifiering av verktyg som behövs
	Identifiering av villkor som måste vara uppfyllda
	Identifiering av ett tillstånd (om ..., så ...)
	Identifiering av ett resultat
[Start]	Identifiering av en tangent eller knapp
[00123456]	Identifiering av ett materialnummer
Status	Identifiering av text/fönster som visas (i maskinens display)

Grafik 3: Allmänna symboler

## 2.1 Allmänna säkerhetsanvisningar

### 2.1.1 Alla hushållsmaskiner

#### **Risk för elstötar på grund av strömförande delar!**

- Fel vid reparationer som berör elkomponenter kan orsaka elstötar!
- Koppla bort maskinen från elnätet minst 60 sekunder innan arbetet påbörjas.
- Låt utföra ett säkerhetstest efter reparationen, i enlighet med VDE 0701 eller landsspecifika regler.

#### **Risk för personskador på grund av vassa kanter!**

- Använd skyddshandskar.

#### **Risk för krosskador vid reparation, underhåll, felsökning och service på grund av tunga och rörliga komponenter**

- Använd skyddsskor.
- Säkra tunga komponenter så att de inte faller ner.
- Stick inte in kroppsdelar i rörliga komponenter.



#### **Risk för maskinens säkerhet/funktion!**

- Använd endast originaldelar.

#### **Risk för skador på komponenter känsliga för statisk elektricitet (ESD)!**

- Rör inte modulerna samt anslutningar och strömförande ledningar.

## Verkt yg och hj alpmedel

Beteckning	Detaljer	Bilder
Skyddstrasa [00342013]	60 cm x 50 cm	
Phillips-skruvmejsel PH2		
Torxbits TX20 [00340865]	6,3 mm (1/4")	
Sp�arskruvmejsel	Blad 2,4 mm x 0.4 mm x 60 mm, i kitet [00341820]	



## 4.1 Byta dörrpackning

### Förutsättning:

- ✔ Dörren är öppen.

### 4.1.1 Ta bort dörrpackning

1. Lossa dörrpackningen från spåret i högra och vänstra hörnet.





2. Dra ut dörrpackningen från spåret.



- ➡ Dörrpackningen har tagits bort.

### 4.1.2 Montera dörrpackning

	Den nya dörrpackningens tjocklek kan avvika något från den gamla dörrpackningens tjocklek. Detta kommer inte påverka stängningsegenskaperna eller funktionen långsiktigt.
	Om apparaten har justerbara gångjärn eller gångjärnsfästen kan du optimera stängningsegenskaperna senare.
	Små sidohål i dörrpackningen fyller en funktion (krävs för ventilation). Dessa utgör inga tillverkningsfel.

## Reparation

1. Kontrollera om spåret för packningen har skador.

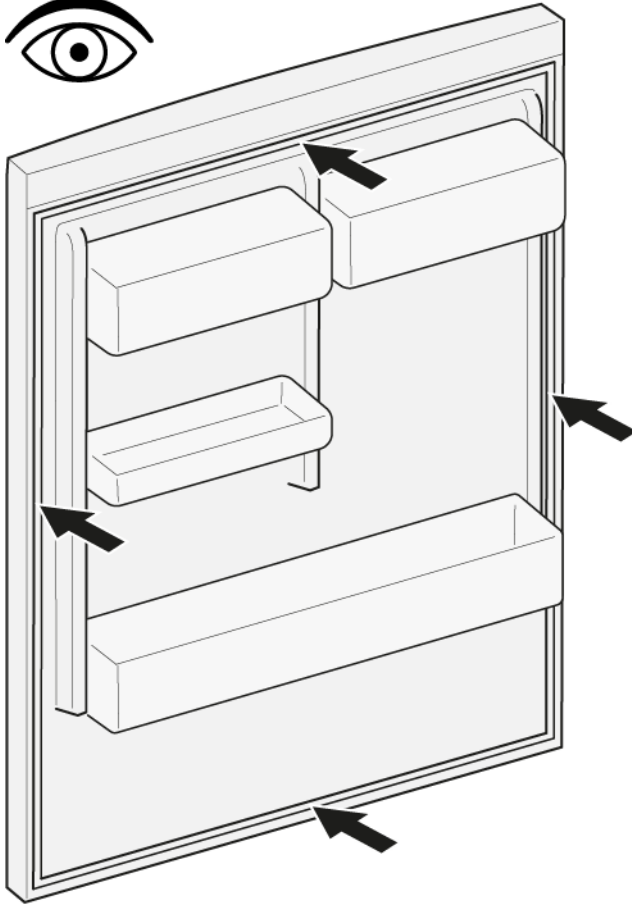

4. Tryck in packningens hörn längst upp och längst ner i spåret.

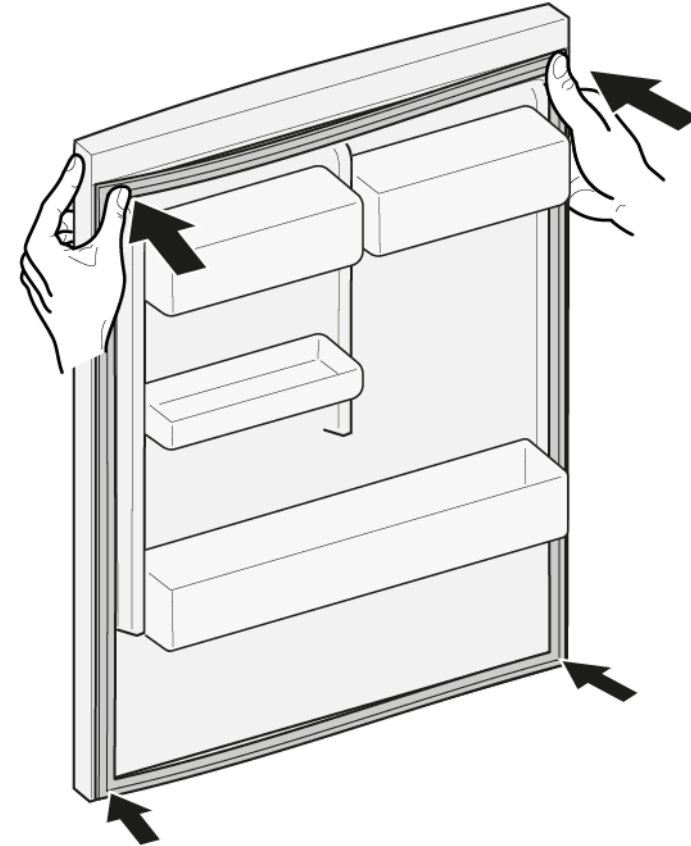

2.  Om spåret för packningen är skadat:
  - Kontakta kundtjänst.

3.  Viss deformation av dörrpackningen är normalt och påverkar inte packningens funktion. Det rekommenderas att man sträcker dörrpackningen innan den sätts in i apparaten.

Värm dörrpackningen med en hårtork eller hett vatten och forma om den med händerna.

## Reparation



5. Tryck in hela packningen i spåret bit för bit.





 Dörrpackningen är monterad.

## 4.2 Byta dörrhandtag

### Nödvändiga verktyg:

-  Torxbits TX20                      6,3 mm (1/4")                      [00340865]
-  Spårskruvmejsel                      Blad 10 mm x 1,6 mm x 200 mm

### Förutsättning:

-  Apparatens är bortkopplad från strömförsörjning.
-  Dörren är öppen.

### 4.2.1 Ta bort dörrhandtag

- ▶ 1. Ta bort de två skruvhättorna (1).
- ▶ 2. Skruva ur de två skruvarna (2).
- ▶ 3. Ta bort dörrhandtaget (3).

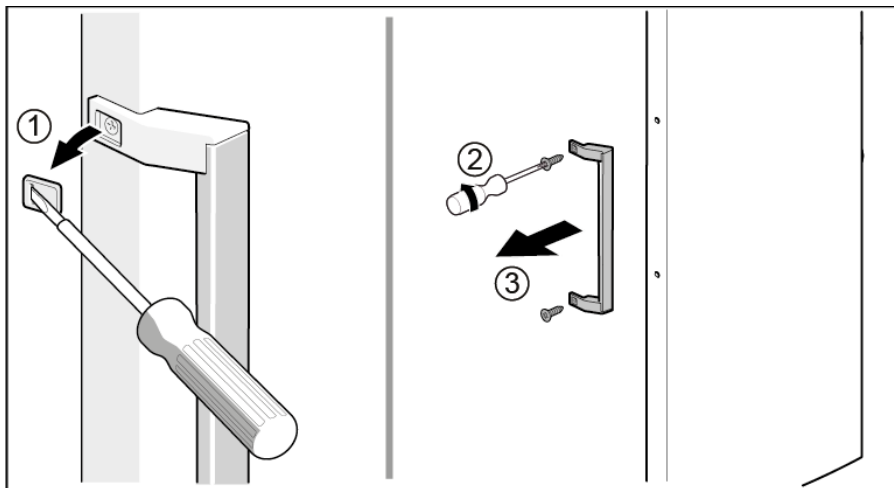

 Dörrhandtaget har tagits bort.

### 4.2.2 Montera dörrhandtag

- ▶ Montera i omvänd ordning.

## 4.3 Byta Easy opening handle

### Nödvändiga verktyg:

- 🔩 Phillips-skruvmejsel PH2

### Förutsättning:

- ✅ Apparaten är bortkopplad från strömförsörjning.
- ✅ Dörren är öppen.

### 4.3.1 Ta bort Easy opening handle

- ▶ 1. Ta bort skyddet för Easy opening handle (1).
- ▶ 2. Skruva ur de två skruvarna (2).

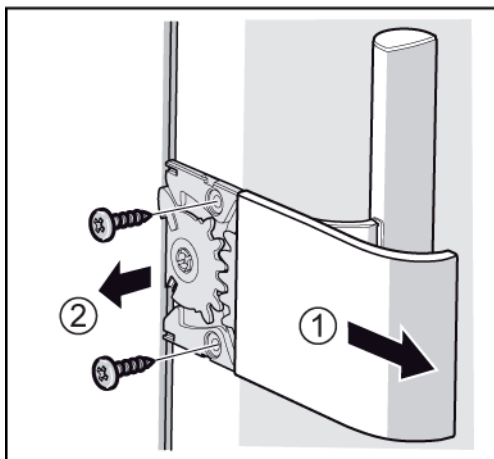

- ➡ Easy opening handle har tagits bort.

## 4.3.2 Montera Easy opening handle

Mekanismen Easy opening handle ska ställas in rätt före monteringen. Rätt placering av tryckstång (1), kuggsegment (2) och (3), fjäder (4) och stopp (5) för dörrens montering på vänster sida visas på bilden.

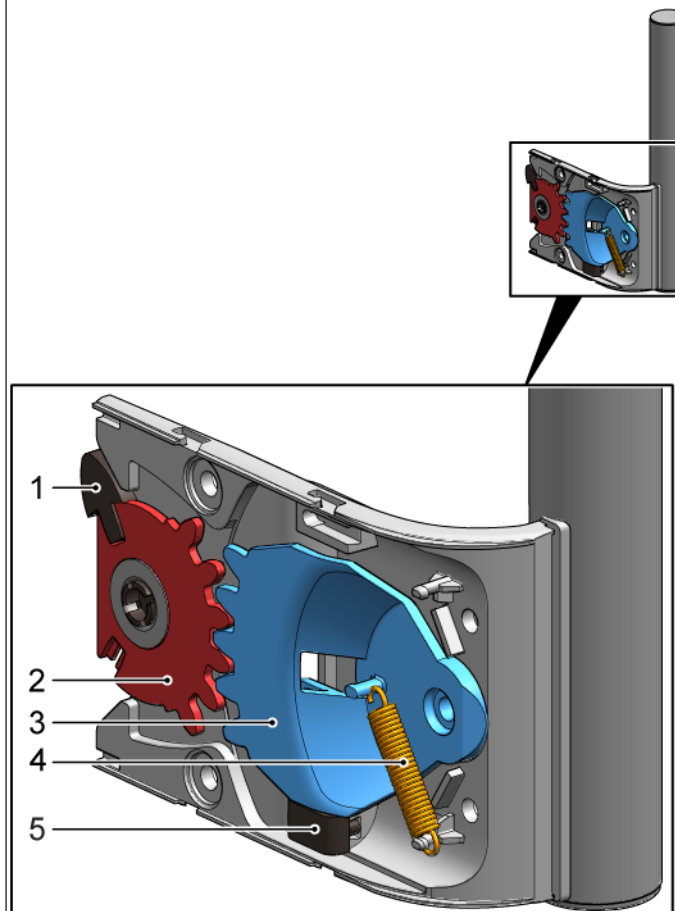

Placeringen av underkomponenter till Easy opening handle för dörrens montering på höger sida står i dokumentet "Monteringsanvisning".

- ▶ Montera i omvänd ordning.

## 4.4 Byta dörrens övre gångjärn

### Nödvändiga verktyg:



 Torxbits TX20

6,3 mm (1/4")

[00340865]

	<p><b>⚠ VARNING!</b></p> <p><b>Tunga och skrymmande apparater!</b> Rygg- och muskelskador</p> <ul style="list-style-type: none"><li>▶ Låt endast utbildad personal ta bort dörren från apparaten.</li><li>▶ Det krävs två personer för att flytta apparaten.</li><li>▶ Använd endast passande verktyg och utrustning.</li></ul>
	<p><b>⚠ FÖRSIKTIGT!</b></p> <p><b>Vassa kanter!</b> Skärskador</p> <ul style="list-style-type: none"><li>▶ Använd skyddshandskar.</li></ul>
	<p><b>⚠ VARNING!</b></p> <p><b>Lutande maskiner kan glida!</b> Frakturer/krosskador</p> <ul style="list-style-type: none"><li>▶ Säkra maskiner så att de inte kan glida.</li></ul>
	<p><b>⚠ FÖRSIKTIGT!</b></p> <p><b>Risk för fallande delar på grund av lossade skruvar!</b> Personskador på grund av fallande delar.</p> <ul style="list-style-type: none"><li>▶ Säkra komponenter så att de inte faller ner.</li></ul>
	<p><b>OBS!</b></p> <p><b>Risk för fallande delar på grund av lossade skruvar!</b> Materiella skador på andra delar av maskinen eller i kundens hem, t.ex. vid botten.</p> <ul style="list-style-type: none"><li>▶ Säkra komponenter så att de inte faller ner.</li></ul>

### Förutsättning:

-  Apparaten är bortkopplad från strömförsörjning.
-  Tillbehör inuti apparaten har tagits bort.

## 4.4.1 Ta bort dörrens gångjärn

## Reparation

1. Lägg ner apparaten på baksidan.

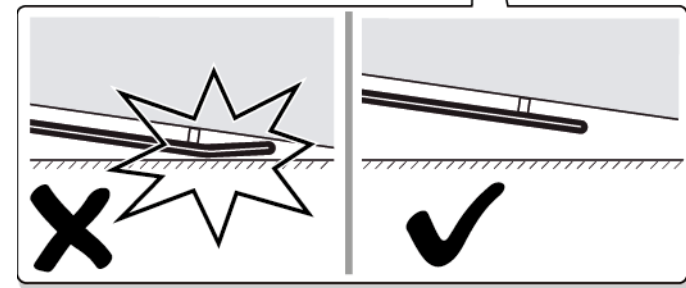
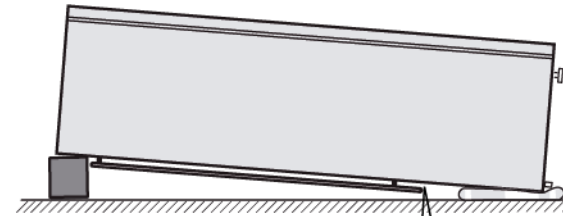
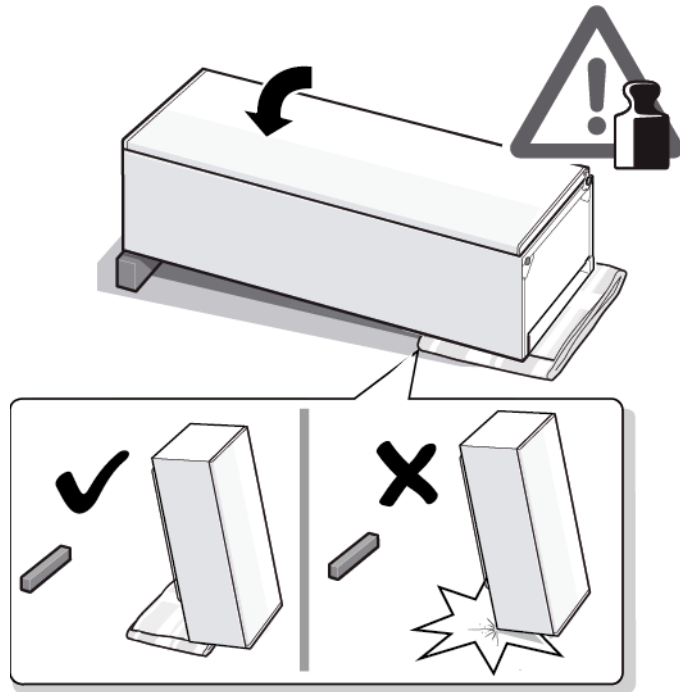

2. 1. Tryck på det övre gångjärnsskyddet på båda sidor (1).  
2. Flytta ut det övre gångjärnsskyddet (2).  
3. Ta bort det övre gångjärnsskyddet (3).

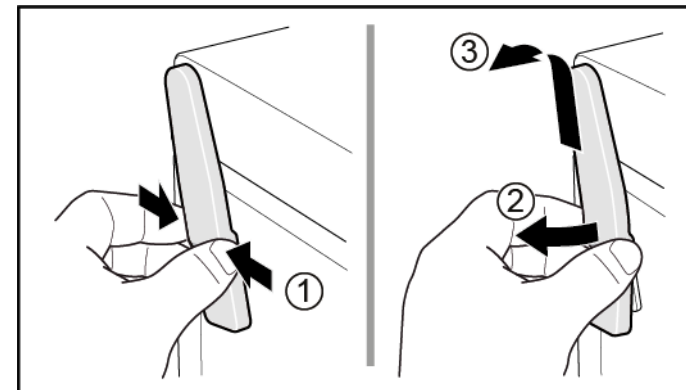

## Reparation

3.
  1. Skruva ur de två skruvarna (1).
  2. Ta bort det övre gångjärnet (2).

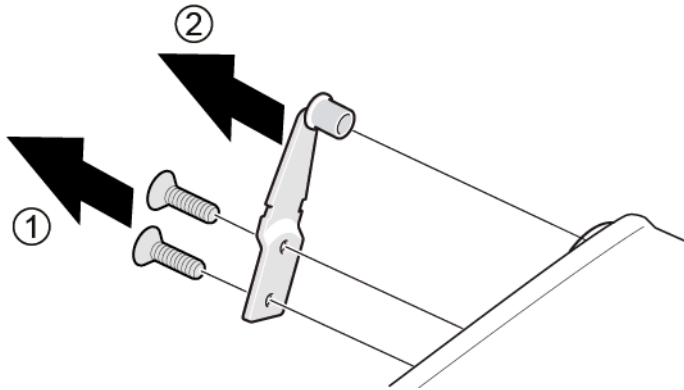

 Dörrens övre gångjärn har tagits bort.

### 4.4.2 Montera dörrens gångjärn

- ▶ Montera i omvänd ordning.



## 4.5 Byta dörrens övre gångjärn (dörr med display)

### Nödvändiga verktyg:

 Torxbits TX20                      6,3 mm (1/4")                      [00340865]

	<b>⚠ VARNING!</b>
	<b>Tunga och skrymmande apparater!</b> Rygg- och muskelskador ▶ Låt endast utbildad personal ta bort dörren från apparaten. ▶ Det krävs två personer för att flytta apparaten. ▶ Använd endast passande verktyg och utrustning.

	<b>⚠ FÖRSIKTIGT!</b>
	<b>Vassa kanter!</b> Skärskador ▶ Använd skyddshandskar.

	<b>⚠ VARNING!</b>
	<b>Lutande maskiner kan glida!</b> Frakturer/krosskador ▶ Säkra maskiner så att de inte kan glida.

	<b>⚠ FÖRSIKTIGT!</b>
	<b>Risk för fallande delar på grund av lossade skruvar!</b> Personskador på grund av fallande delar. ▶ Säkra komponenter så att de inte faller ner.

	<b>OBS!</b>
	<b>Risk för fallande delar på grund av lossade skruvar!</b> Materiella skador på andra delar av maskinen eller i kundens hem, t.ex. vid botten. ▶ Säkra komponenter så att de inte faller ner.

	<b>⚠ FARA!</b>
	<b>Risk för elstötar på grund av strömförande delar!</b> Livsfara på grund av elstötar vid felaktiga reparationer ▶ Elektriska delar ska repareras av behörig elektriker. ▶ Låt utföra ett säkerhetstest efter reparationen, i enlighet med VDE 0701 eller landsspecifika regler.

	<b>⚠ FARA!</b>
	<b>Risk för elstötar på grund av strömförande delar!</b> Dödsfall på grund av elstötar ▶ Koppla bort maskiner från elförsörjningen minst 60 sekunder innan reparationer påbörjas.

### Förutsättning:

- Apparaten är bortkopplad från strömförsörjning.
- Tillbehör inuti apparaten har tagits bort.

## 4.5.1 Ta bort dörrens gångjärn

1. Lägg ner apparaten på baksidan.

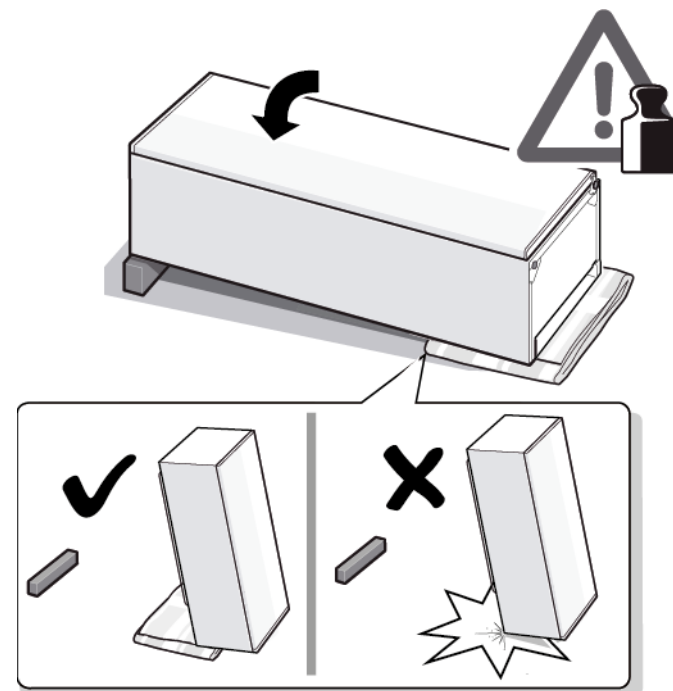

## Reparation

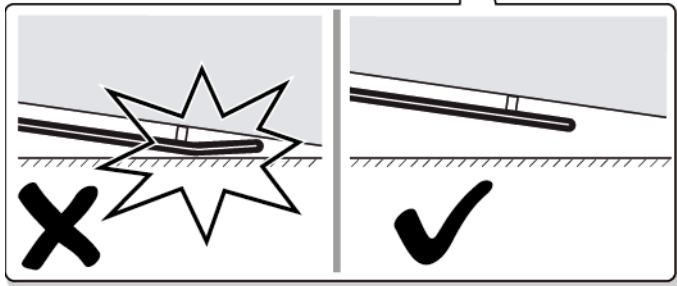
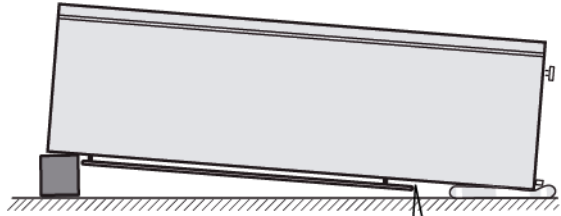

1. Tryck på det övre gångjärnsskyddet på båda sidor (1).
2. Flytta ut det övre gångjärnsskyddet (2).
3. Ta bort det övre gångjärnsskyddet (3).

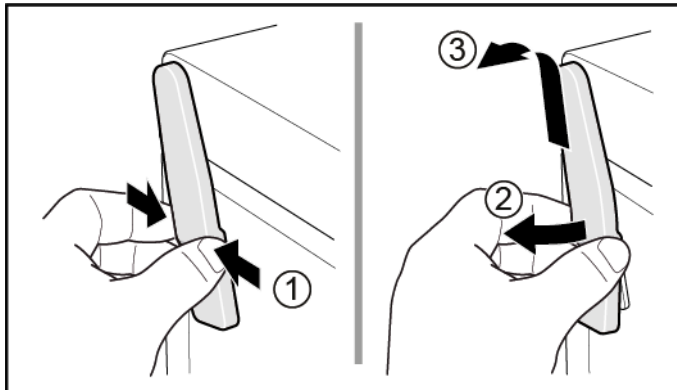

3. 1. Ta bort kabelboxhöljet (1).
2. Ta bort kabelskyddet (2).
3. Lossa elanslutningen (3).
4. Skruva ur de två skruvarna (4).
5. Ta bort det övre gångjärnet (5).

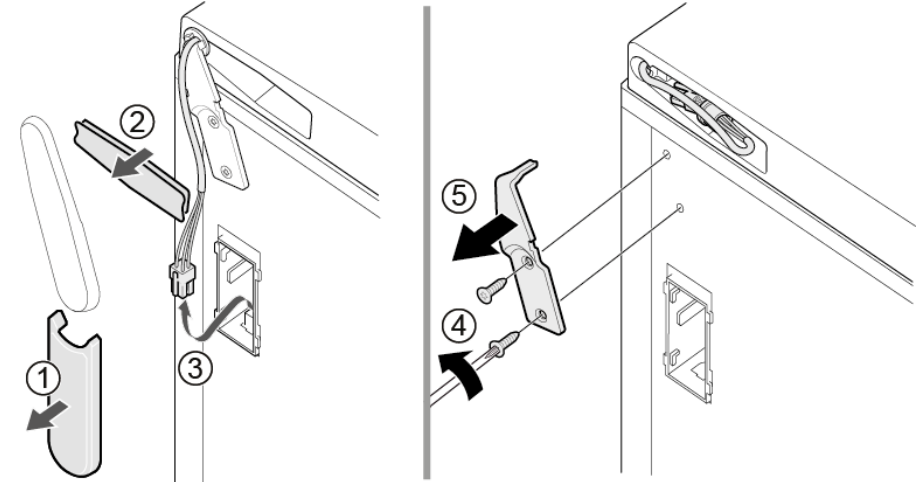

➔ Dörrens övre gångjärn har tagits bort.

### 4.5.2 Montera dörrens gångjärn

- ▶ Montera i omvänd ordning.

## 4.6 Byta dörrens nedre gångjärn

Nödvändiga verktyg:

Torxbits TX20

6,3 mm (1/4")

[00340865]

	<p><b>⚠ VARNING!</b></p> <p><b>Tunga och skrymmande apparater!</b> Rygg- och muskelskador</p> <ul style="list-style-type: none"> <li>▶ Låt endast utbildad personal ta bort dörren från apparaten.</li> <li>▶ Det krävs två personer för att flytta apparaten.</li> <li>▶ Använd endast passande verktyg och utrustning.</li> </ul>
	<p><b>⚠ FÖRSIKTIGT!</b></p> <p><b>Vassa kanter!</b> Skärskador</p> <ul style="list-style-type: none"> <li>▶ Använd skyddshandskar.</li> </ul>
	<p><b>⚠ VARNING!</b></p> <p><b>Lutande maskiner kan glida!</b> Frakturer/krosskador</p> <ul style="list-style-type: none"> <li>▶ Säkra maskiner så att de inte kan glida.</li> </ul>
	<p><b>⚠ FÖRSIKTIGT!</b></p> <p><b>Risk för fallande delar på grund av lossade skruvar!</b> Personskador på grund av fallande delar.</p> <ul style="list-style-type: none"> <li>▶ Säkra komponenter så att de inte faller ner.</li> </ul>
	<p><b>OBS!</b></p> <p><b>Risk för fallande delar på grund av lossade skruvar!</b> Materiella skador på andra delar av maskinen eller i kundens hem, t.ex. vid botten.</p> <ul style="list-style-type: none"> <li>▶ Säkra komponenter så att de inte faller ner.</li> </ul>

Förutsättning:

- ✓ Apparaten är bortkopplad från strömförsörjning.
- ✓ Tillbehör inuti apparaten har tagits bort.
- ✓ Apparaten ligger på baksidan.
- ✓ [Det övre gångjärnet har tagits bort.→513](#)

### 4.6.1 Byta dörrens nedre gångjärn

1. Ta bort dörren.

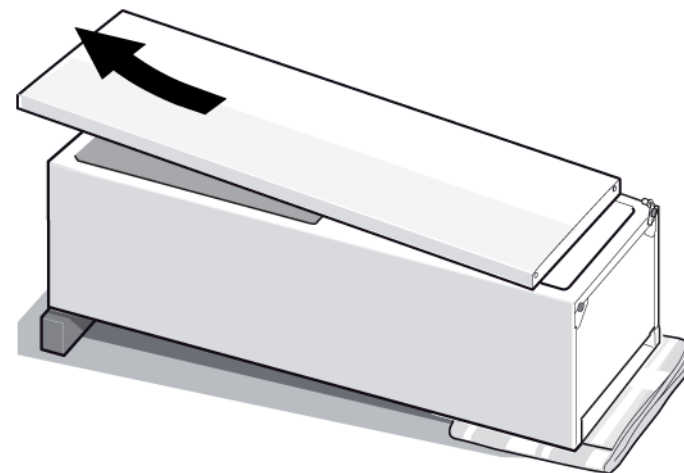

2.
  1. Skruva ur skruven (1).
  2. Vrid ut det nedre gångjärnet (2).
  3. Ta bort det nedre gångjärnet (3).

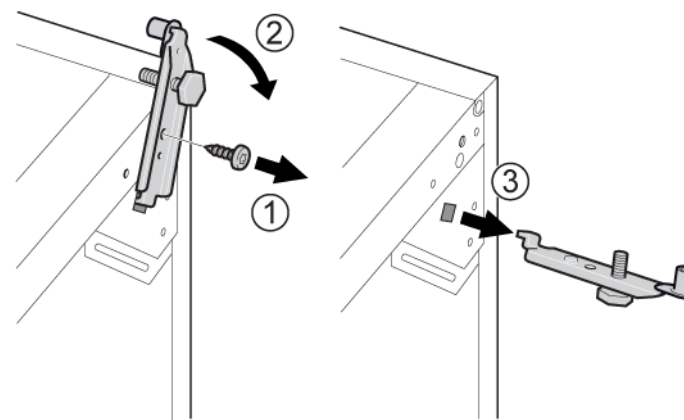

➡ Det nedre gångjärnet har tagits bort.

### 4.6.2 Montera dörrens nedre gångjärn

- ▶ Montera i omvänd ordning.

## 4.7 Byta hylla

### Förutsättning:

- ✔ Dörren är öppen.

### 4.7.1 Ta bort hylla

- ▶ Dra ut hyllan.

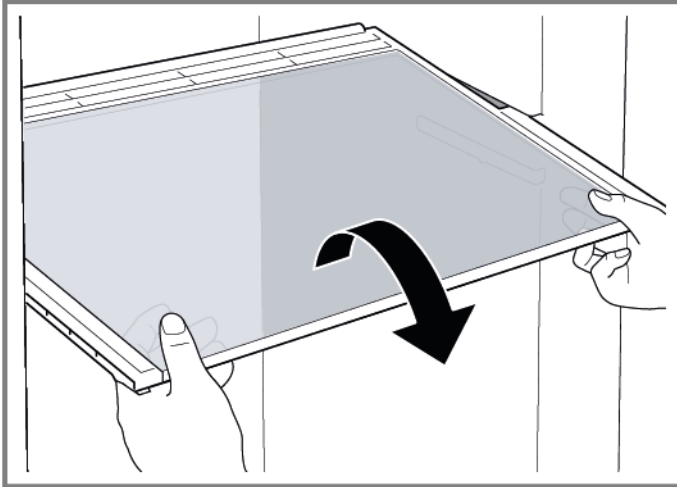

- ➡ Hyllan har tagits bort.

### 4.7.2 Montera hylla

- ▶ Montera i omvänd ordning.

## 4.8 Byta fack för frysta matvaror

### Förutsättning:

- ✓ Dörren är öppen.

### 4.8.1 Ta bort fack för frysta matvaror

- ▶ 1. Dra ut facket för frysta matvaror helt (1).
- ▶ 2. Ta bort facket för frysta matvaror (2).

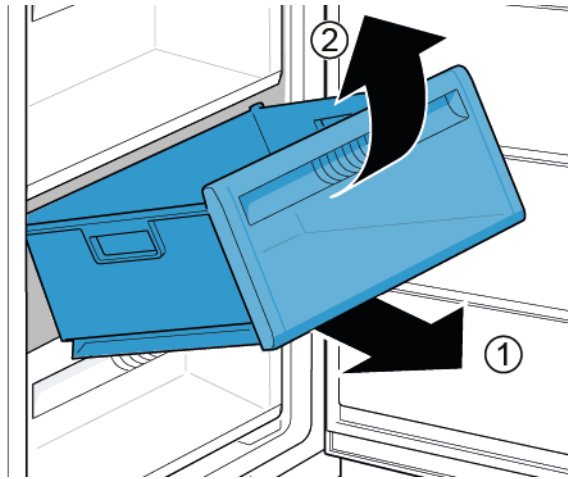

- ➡ Facket för frysta matvaror har tagits bort.

### 4.8.2 Montera fack för frysta matvaror

- ▶ Montera i omvänd ordning.

## 4.9 Byta ismaskin

### Förutsättning:

- ✔ Dörren är öppen.

### 4.9.1 Ta bort ismaskin

- ▶ 1. Dra ut hyllan med facket för frysta matvaror med ismaskin (1).
- ▶ 2. Lossa hakarna (2).
- ▶ 3. Ta bort ismaskinen (3).

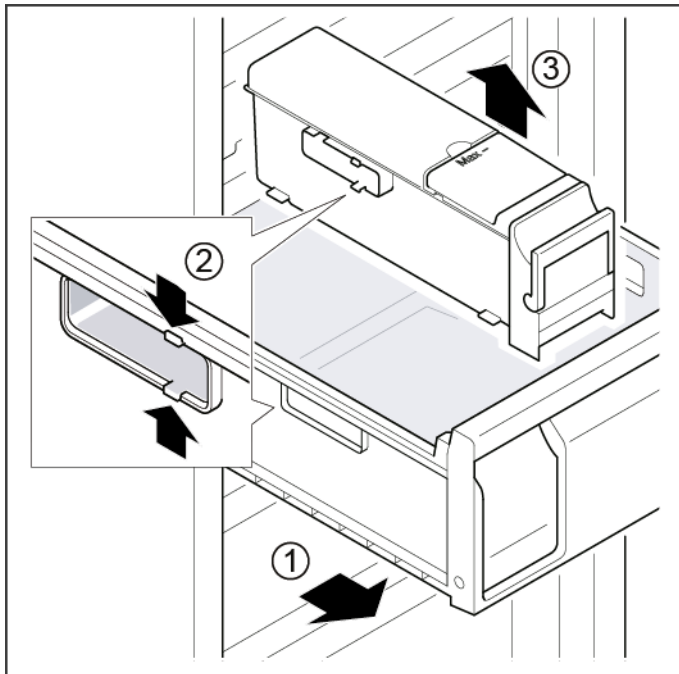

➡ Ismaskinen har tagits bort.

### 4.9.2 Montera ismaskin

- ▶ Montera i omvänd ordning.

## 4.10 Byta översta LED-lampan

### Nödvändiga verktyg:

Spårskruvmejsel

Blad 2,4 mm x 0.4 mm x 60 mm, i kitet [00341820]



Din apparat har en underhållsfri LED-lampa. Dessa lampor får endast bytas av kundtjänst eller auktoriserade tekniker!



### **FARA!**

#### Risk för elstötar på grund av strömförande delar!

Livs fara på grund av elstötar vid felaktiga reparationer

- ▶ Elektriska delar ska repareras av behörig elektriker.
- ▶ Låt utföra ett säkerhetstest efter reparationen, i enlighet med VDE 0701 eller landsspecifika regler.



### **FARA!**

#### Risk för elstötar på grund av strömförande delar!

Dödsfall på grund av elstötar

- ▶ Koppla bort maskiner från elförsörjningen minst 60 sekunder innan reparationer påbörjas.



### **FÖRSIKTIGT!**

#### Vassa kanter!

Skärskador

- ▶ Använd skyddshandskar.

### Förutsättning:

- ✓ Apparaten är bortkopplad från strömförsörjning.
- ✓ Dörren är öppen.
- ✓ Tillbehör överst inuti apparaten har tagits bort.

### 4.10.1 Ta bort LED-lampan

1. Flytta LED-lampan åt vänster.

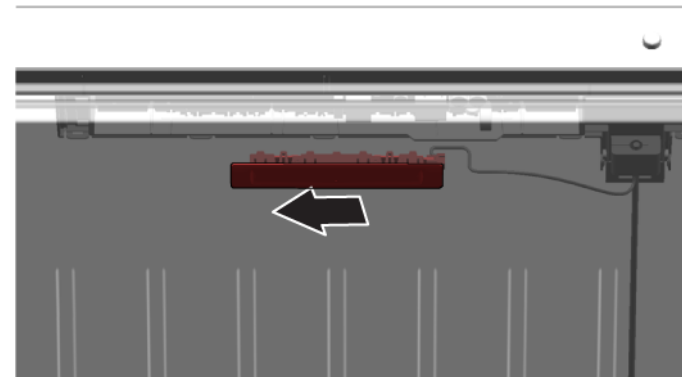

2. LED-lampans elanslutning är bortkopplad.

2. Lossa LED-lampans hakar.

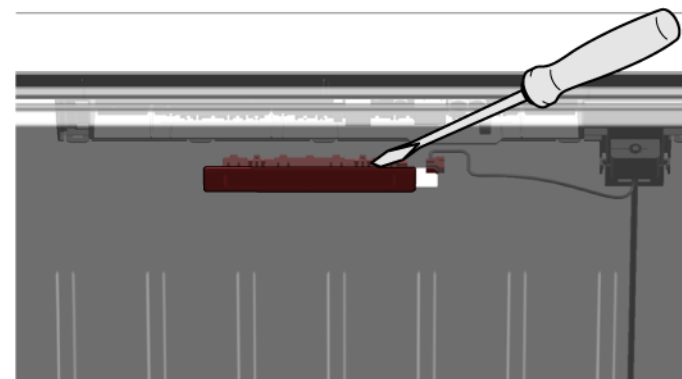



## Reparation

3. Ta bort LED-lampan genom att flytta den framåt.

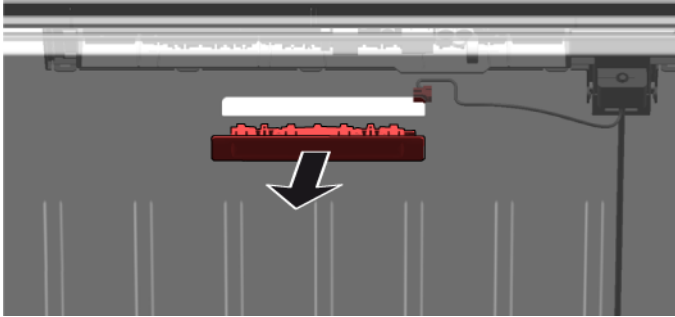

- ➡ LED-lampan har tagits bort.

### 4.10.2 Montera översta LED-lampan

- ▶ Montera i omvänd ordning.

# Onarım İpuçları - Dondurucu

## Bu doküman hakkında ..... 523

- 1.1 Önemli bilgi ..... 523
  - 1.1.1 Amacı..... 523
- 1.2 Sembollerinin açıklaması ..... 523
  - 1.2.1 Tehlike kademeleri ..... 523
  - 1.2.2 Tehlike sembolleri ..... 523
  - 1.2.3 İkaz bilgilerinin yapısı ..... 524
  - 1.2.4 Genel semboller..... 524

## Güvenlik..... 525

- 2.1 Genel Güvenlik bilgileri ..... 525
  - 2.1.1 Tüm ev gereçleri ..... 525

## Ekipman ve yardım..... 526

## Onarım..... 527

- 4.1 Kapı contasının değiştirilmesi ..... 527
  - 4.1.1 Kapı contasının çıkartılması..... 527
  - 4.1.2 Kapı contasının takılması ..... 527
- 4.2 Kapı tutamağının değiştirilmesi..... 530
  - 4.2.1 Kapı tutamağının çıkartılması ..... 530
  - 4.2.2 Kapı tutamağının takılması ..... 530
- 4.3 Easy opening handle tutamağın değiştirilmesi ..... 531
  - 4.3.1 Easy opening handle tutamağın sökülmesi ..... 531
  - 4.3.2 Easy opening handle tutamağının takılması..... 531
- 4.4 Kapının üst menteşesinin değiştirilmesi..... 532
  - 4.4.1 Kapı menteşesinin sökülmesi..... 532
  - 4.4.2 Kapı menteşesinin takılması ..... 534
- 4.5 Kapının üst menteşesinin değiştirilmesi (göstergeli kapı)..... 535
  - 4.5.1 Kapı menteşesinin sökülmesi..... 536
  - 4.5.2 Kapı menteşesinin takılması ..... 537
- 4.6 Kapının alt menteşesinin değiştirilmesi..... 538
  - 4.6.1 Kapının alt menteşesinin değiştirilmesi ..... 538
  - 4.6.2 Kapının alt menteşesinin takılması ..... 538
- 4.7 Raf yüzeyinin değiştirilmesi ..... 539
  - 4.7.1 Raf yüzeyinin çıkartılması ..... 539
  - 4.7.2 Raf yüzeyinin takılması..... 539

- 4.8 Dondurulacak gıda kabının değiştirilmesi..... 540
  - 4.8.1 Dondurulacak gıda kabının çıkartılması ..... 540
  - 4.8.2 Dondurulacak gıda kabının takılması ..... 540
- 4.9 Buzmatığının değiştirilmesi ..... 541
  - 4.9.1 Buzmatığının çıkartılması ..... 541
  - 4.9.2 Buzmatığının takılması..... 541
- 4.10 LED Üst aydınlatmanın değiştirilmesi ..... 542
  - 4.10.1 LED Lambanın sökülmesi ..... 542
  - 4.10.2 Üst LED ışığının takılması..... 543

# **i** Bu doküman hakkında

## 1.1 Önemli bilgi

### 1.1.1 Amacı

Bu onarım ipuçları, tüketicinin cihazları, geçerli eko-tasarım yönetmeliğine göre (03/2021 itibarıyla) kendi başına onarması için destek sunar.

İpuçları, tanımlanmış yedek parçaların nasıl değiştirilmesi gerektiğine dair bilgiler, uyarılar ve söz konusu riskleri içerir.

Sorularınız varsa, lütfen yetkili servisimizle irtibata geçiniz. Yalnızca onarım ipuçlarına gerektiği gibi uyulduğu takdirde hasarlar için sorumluluk üstleniriz.

## 1.2 Sembollerinin açıklaması

### 1.2.1 Tehlike kademeleri

Tehlike kademeleri bir sembolden ve bir sinyal kelimesinden oluşur. Sinyal kelimesi tehlikenin şiddetini ve önemini tanımlar.





Tehlike kademesi	Anlamı
 <b>TEHLİKE</b>	İkaz bilgisinin dikkate alınmaması ölüme veya ağır yaralanmalara sebep olur.
 <b>UYARI</b>	İkaz bilgisinin dikkate alınmaması ölüme veya ağır yaralanmalara sebep olabilir.
 <b>DİKKAT</b>	İkaz bilgisinin dikkate alınmaması hafif yaralanmalara sebep olabilir.
 <b>DİKKATI</b>	İkaz bilgisinin dikkate alınmaması maddi hasarların oluşmasına sebep olabilir.

Tablo 1: Tehlike kademeleri



### 1.2.2 Tehlike sembolleri

Tehlike sembolleri, tehlike türü hakkında bilgi veren anlamlı resimsel gösterimlerdir.

Bu dokümanda aşağıdaki tehlike sembolleri kullanılmıştır:

Tehlike sembolü	Anlamı
	Genel ikaz bilgisi
	Elektrik geriliminden kaynaklanan tehlike
	Patlamadan kaynaklanan tehlike
	Kesmeden dolayı yaralanma tehlikesi
	Sıkışıp ezilmeden dolayı yaralanma tehlikesi

## **i** Bu doküman hakkında

Tehlike sembolü	Anlamı
	Sıcak yüzeylerden kaynaklanan tehlike
	Güçlü elektromanyetik alan tehlikesi
	İyonizasyon olmayan ışınlardan kaynaklanan tehlike

Tablo 2: Tehlike sembolleri

### 1.2.3 İkaz bilgilerinin yapısı

Bu dokümandaki ikaz bilgilerinin standart olarak görünüşü ve yapısı aynıdır.



	<b>⚠ TEHLİKE</b> <b>Tehlikenin türü ve kaynağı!!</b> Tehlike / ikaz bilgisinin dikkate alınmamasının sonucu. ► Tehlikeye karşı korunmak için yapılacak işlem ve yasaklar.
--	--







Aşağıdaki örnekte, gerilim ileten parçalar nedeniyle oluşabilecek elektrik çarpması tehlikesi hakkında uyarıda bulunan bir ikaz bilgisi gösterilmiştir. Tehlikeyi önlemek için alınması gereken önlemler belirtilmiştir.

	<b>⚠ TEHLİKE</b> <b>Gerilim ileten parçalar nedeniyle elektrik çarpması tehlikesi!!</b> Elektrik çarpması sebebiyle ölüm ► Onarıma başlamadan önce cihazın elektrik şebeke bağlantısını en az 60 saniye süreyle sökün.
---	---

### 1.2.4 Genel semboller

Bu dokümanda aşağıdaki genel semboller kullanılmıştır:

Genel sembol	Anlamı
	Özel ipucu işareti (metin ve/veya grafik)
	Basit ipucu işareti (yalnızca metin)
	Video linki işareti

Genel sembol	Anlamı
	Gerekli araçlar işareti
	Ön koşulların işareti
	Koşul işareti (... olursa .... olur)
	Sonuç işareti
	Tuş veya düğme işareti
	Malzeme numarası işareti
	Gösterilen yazı / ekran işareti (cihaz ekranındaki)

Tablo 3: Genel semboller

## **2.1 Genel Güvenlik bilgileri**

### **2.1.1 Tüm ev gereçleri**

#### **Gerilim ileten parçalar nedeniyle elektrik çarpması tehlikesi!**

- Elektrikli bileşenlerde yapılan onarımlarda hatalar, elektrik çarpmasına neden olabilir!
- Cihaz çalışmalara başlamadan en az 60 saniye önce elektrik şebekesinden ayrılmalıdır.
- Onarım sonrasında VDE 0701 veya ülkeye özel düzenlemeler uyarınca bir güvenlik testi gerçekleştirilmelidir.

#### **Keskin kenarlar nedeniyle yaralanma tehlikesi!**

- Koruyucu eldiven kullanılmalıdır.

#### **Ağır ve hareketli parçaların onarım, bakım, hata arama ve servis işlemlerinde yaratabileceği ezilme riskleri**

- Koruyucu ayakkabı giyin.
- Yere düşmemesi için ağır parçaları emniyete alın.
- Hareketli parçaların arasına gövde parçaları koymayın.



#### **Cihaz güvenliğinde / fonksiyonda tehlike!**

- Yalnızca orijinal parçalar kullanılmalıdır.

#### **Elektrostatik hassasiyeti olan bileşenlerde hasar tehlikesi (ESD)!**

- Bağlantılar ve iletken yolları da dahil olmak üzere modüllere dokunmayın.

## Ekipman ve yardım

Tanımlama	Detaylar	Görüntüler
Koruyucu bez [00342013]	60 cm x 50 cm	
Yıldız Tornavida PH2		
Torx Bit TX20 [00340865]	6,3 mm (1/4")	
Düz tornavida	Bıçak 2,4 mm x 0,4 mm x 60 mm, [00341820] numaralı kit içinde	

## 4.1 Kapı contasının değiştirilmesi

Ön koşul:

- ✓ Kapı açık.

### 4.1.1 Kapı contasının çıkartılması

1. Kapı contasını sağ ve sol köşedeki oluklardan kurtarın.

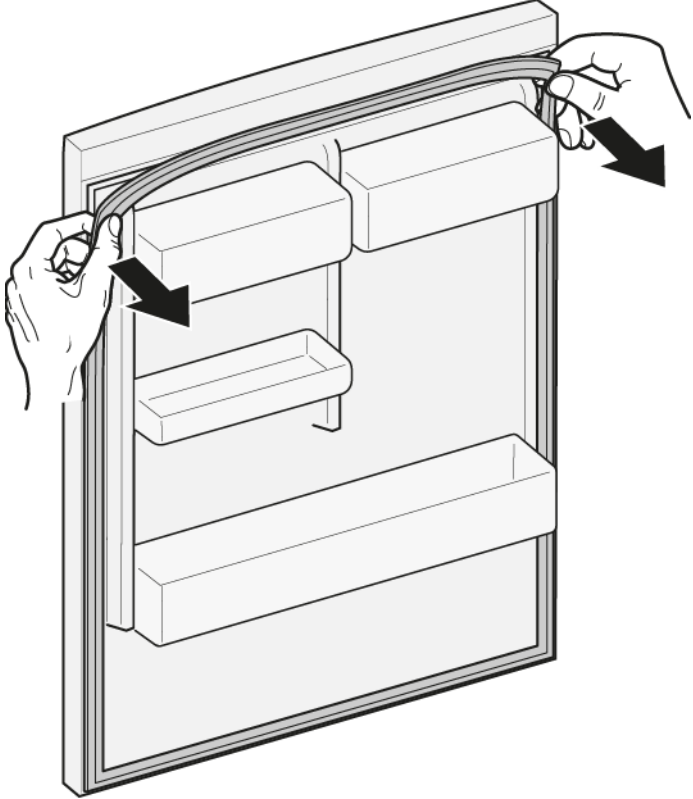

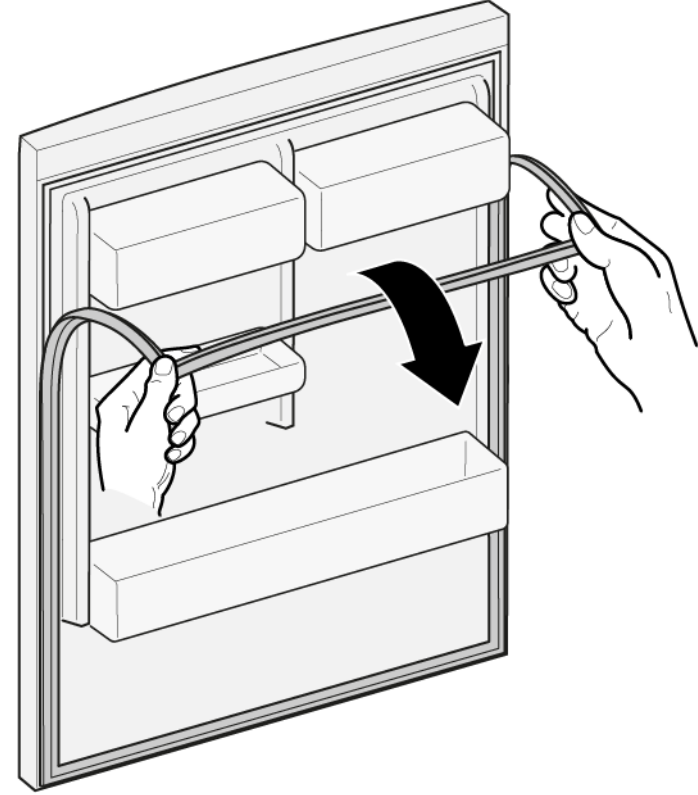

2. Kapı contasını oluktan dışarı çekin.



- ➡ Kapı contası çıkartılmıştır.

### 4.1.2 Kapı contasının takılması

	Yeni kapı contasının kalınlığı, eski kapı contasının kalınlığından biraz farklı olabilir. Bu, kapının kapanma özelliğini ve uzun süreli işlevini etkilemez.
	Cihazınızda ayarlanabilir menteşeler veya menteşe ekleri varsa, kapının kapanma özelliğini daha sonra optimize edebilirsiniz.
	Kapı contasındaki küçük yan delikler işlevseldir (havalandırma için gereklidir). Bunlar üretim hatası değildir.

1. Conta için oluğu hasar bakımından kontrol edin.

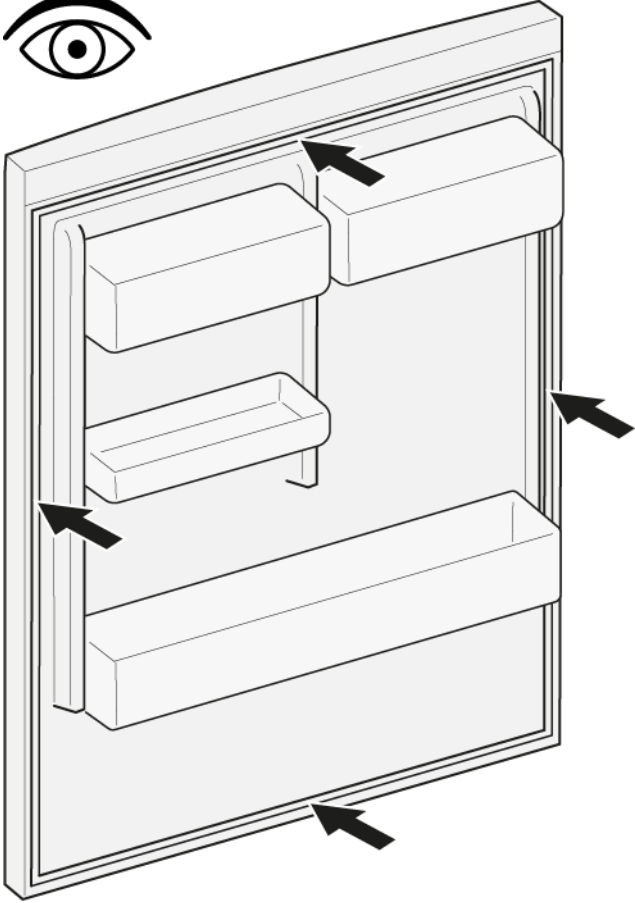

4. Contanın köşelerini üstten ve alttan oluğa itin.

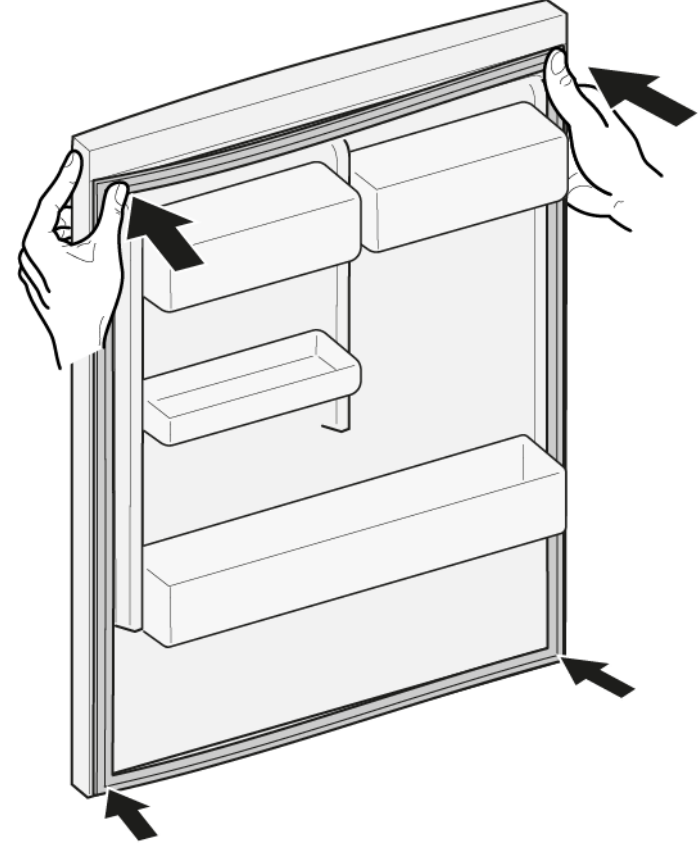

2.  Conta için oluk hasarlı ise,  
- Müşteri hizmetleriyle irtibata geçin.

3.  Kapı contasında hafif deformasyon normaldir ve contanın işlevini etkilemez. Kapı contasını cihaza yerleştirmeden önce contanın düzleştirilmesi önerilir.

Kapı contasını bir saç kurutma makinesi veya sıcak suyla ısıtın ve manuel olarak şekillendirin.



5. Contanın tamamını adım adım oluğun içine bastırın.

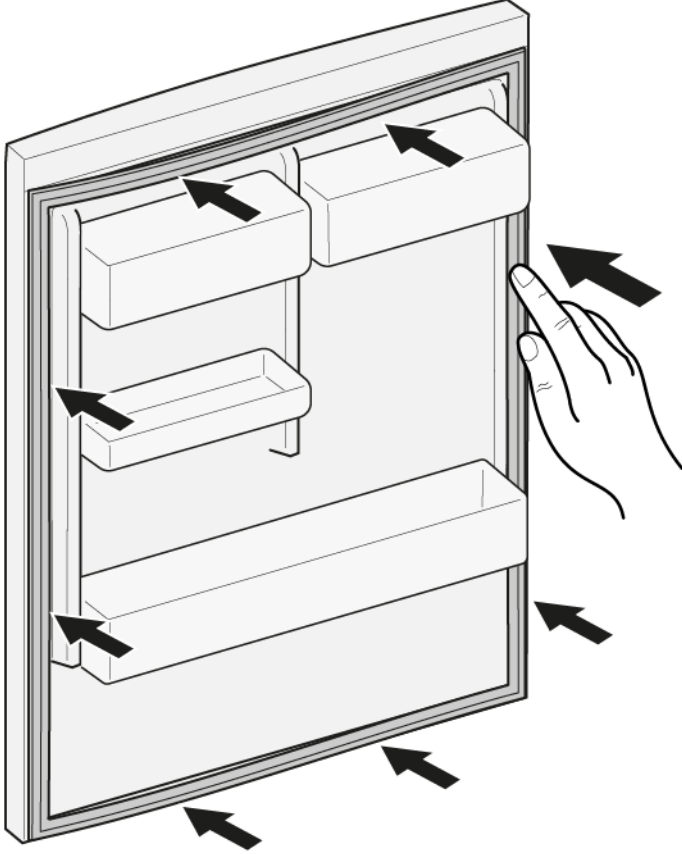

 Kapı contası takılmıştır.

## 4.2 Kapı tutamağının değiştirilmesi

Özel yardımcı ekipman:

- Torx Bit TX20 6,3 mm (1/4") [00340865]
- Düz tornavida Bıçak 10 mm x 1,6 mm x 200 mm

Ön koşul:

- ✓ Cihazın fişi çekilir.
- ✓ Kapı açık.

### 4.2.1 Kapı tutamağının çıkartılması

- 1. İki vidalı kapağı çıkartın (1).
- 2. Vidaları sökün (2).
- 3. Kapı tutamağını çıkartın (3).

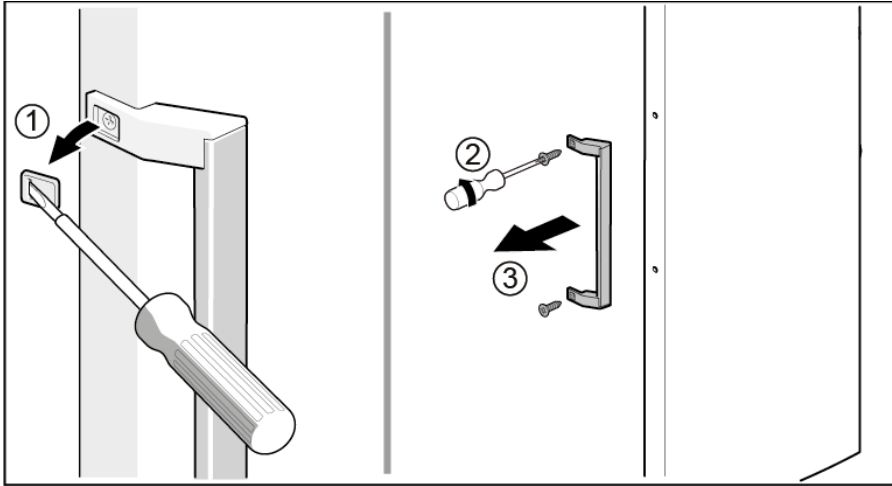

➡ Kapı tutamağı çıkartılmıştır.

### 4.2.2 Kapı tutamağının takılması

- Ters sıra ile monte edin.

## 4.3 Easy opening handle tutamağın değiştirilmesi

Özel yardımcı ekipman:

Yıldız Tornavida PH2

Ön koşul:

- ✓ Cihazın fişi çekilir.
- ✓ Kapı açık.

### 4.3.1 Easy opening handle tutamağın sökülmesi

- ▶ 1. Easy opening handle tutamağının kapağını çıkarın (1).
- ▶ 2. Vidaları sökün (2).

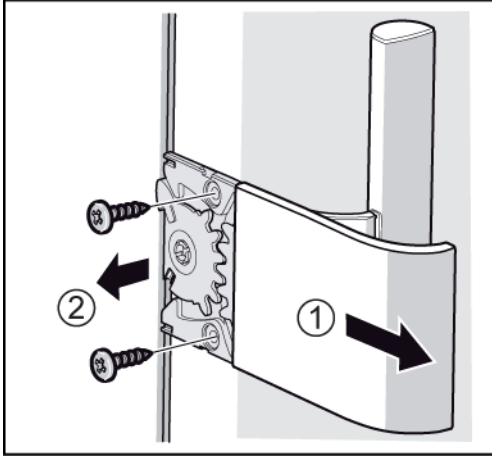

Easy opening handle tutamağı söküldü.

### 4.3.2 Easy opening handle tutamağının takılması

Easy opening handle mekanizması kurulumdan önce uygun şekilde ayarlanmalıdır.  
Kapı sol taraf montajı için milin (1), dişli kadrınların (2) ve (3), yayın (4) and limit durdurmanın (5) doğru düzenlenmesi grafikte gösterilmiştir.

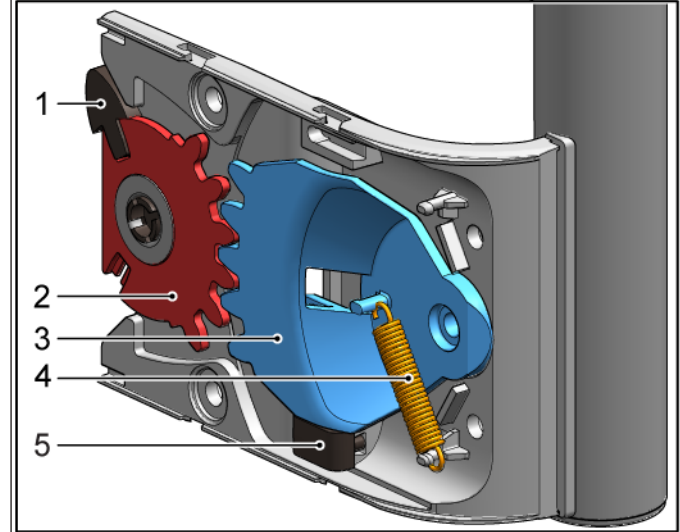

Sağ kapı montajı için easy opening handle alt bileşenlerinin düzeni "Kurulum talimatı" belgesinde tarif edilmiştir.

- ▶ Ters sıra ile monte edin.

#### 4.4 Kapının üst menteşesinin değiştirilmesi

Özel yardımcı ekipman:

 Torx Bit TX20

6,3 mm (1/4")

[00340865]

	<b>UYARI</b> <b>Ağır, büyük cihazlar!</b> Sırt ve kas yaralanmaları <ul style="list-style-type: none"><li>▶ Cihaz kapısını çıkarma işlemi sadece eğitimli uzmanlar tarafından gerçekleştirilmelidir.</li><li>▶ Cihazı hareket ettirmek için iki kişi gereklidir.</li><li>▶ Sadece uygun aletler ve ekipmanlar kullanın.</li></ul>
--	---

	<b>DİKKAT</b> <b>Keskin köşeler!</b> Kesik yaralanmaları <ul style="list-style-type: none"><li>▶ Koruyucu eldiven kullanılmalıdır.</li></ul>
--	--

	<b>UYARI</b> <b>Eğilmiş cihazların kayması!</b> Kemik kırılmaları / çarpma sonucu yaralanmalar <ul style="list-style-type: none"><li>▶ Cihazları kaymaya karşı emniyete alın.</li></ul>
--	---

	<b>DİKKAT</b> <b>Vidaların gevşetilmesi nedeniyle parçaların düşme tehlikesi!</b> Düşen parçalar nedeniyle yaralanma. <ul style="list-style-type: none"><li>▶ Bileşenleri düşmeye karşı emniyete alın.</li></ul>
---	--

	<b>DİKKAT!</b> <b>Vidaların gevşetilmesi nedeniyle parçaların düşme tehlikesi!</b> Cihazın diğer parçalarında veya müşterinin evinde (örn. zemin) hasarlar. <ul style="list-style-type: none"><li>▶ Bileşenleri düşmeye karşı emniyete alın.</li></ul>
--	--

Ön koşul:

- ✓ Cihazın fişi çekilir.
- ✓ Cihazın iç donanımları çıkartılmıştır.

#### 4.4.1 Kapı menteşesinin sökülmesi

1. Cihazı arka tarafına yatırın.

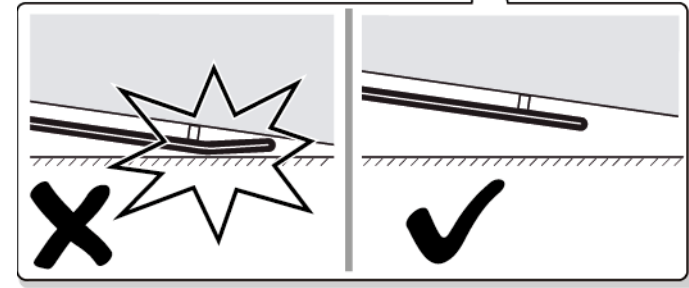
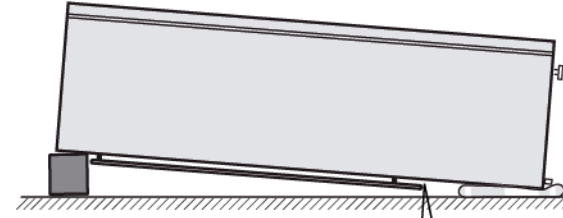
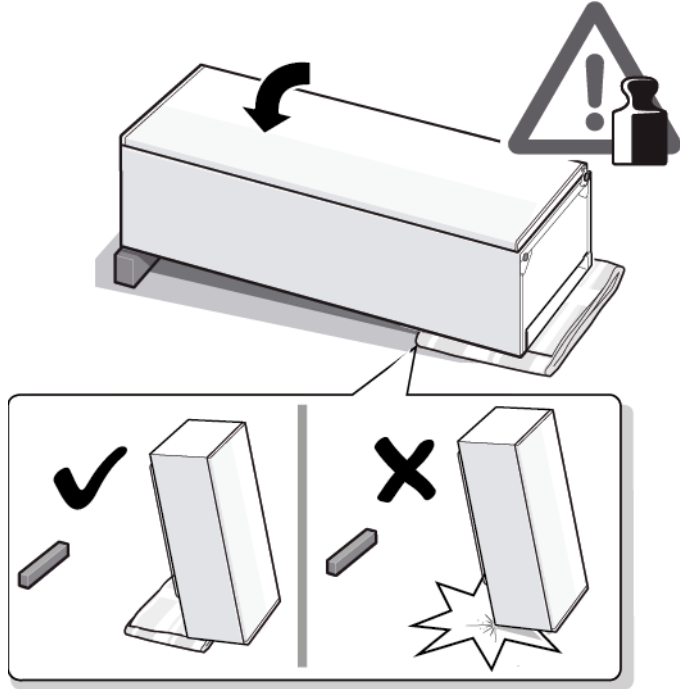

1. Üst menteşe kapağını iki tarafta da bastırın (1).
2. Üst menteşe kapağını çıkartın (2).
3. Üst menteşe kapağını sökün (3).

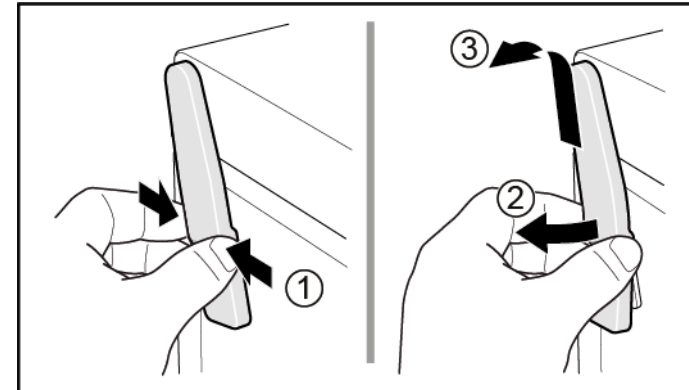

## Onarım

3. 1. Vidaları sökün (1).
2. Üst menteşeyi çıkartın (2).

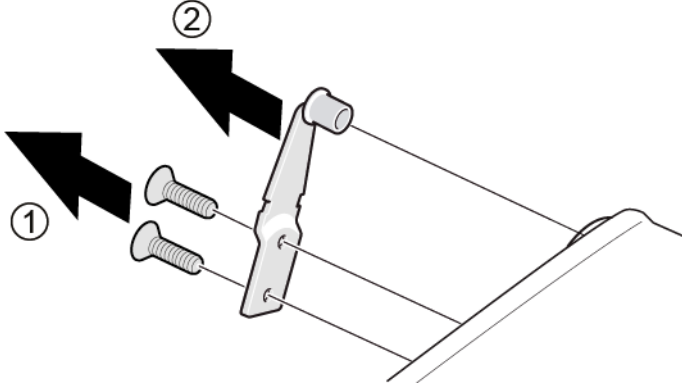

 Kapının üst menteşesi çıkartılmıştır.

### 4.4.2 Kapı menteşesinin takılması

- ▶ Ters sıra ile monte edin.

#### 4.5 Kapının üst menteşesinin değiştirilmesi (göstergeli kapı)

Özel yardımcı ekipman:

 Torx Bit TX20

6,3 mm (1/4")

[00340865]

	<b>UYARI</b> <b>Ağır, büyük cihazlar!</b> Sırt ve kas yaralanmaları ▶ Cihaz kapısını çıkarma işlemi sadece eğitimli uzmanlar tarafından gerçekleştirilmelidir. ▶ Cihazı hareket ettirmek için iki kişi gereklidir. ▶ Sadece uygun aletler ve ekipmanlar kullanın.
--	--

	<b>DİKKAT</b> <b>Keskin köşeler!</b> Kesik yaralanmaları ▶ Koruyucu eldiven kullanılmalıdır.
--	---

	<b>UYARI</b> <b>Eğilmiş cihazların kayması!</b> Kemik kırılmaları / çarpma sonucu yaralanmalar ▶ Cihazları kaymaya karşı emniyete alın.
--	--



	<b>DİKKAT</b> <b>Vidaların gevşetilmesi nedeniyle parçaların düşme tehlikesi!</b> Düşen parçalar nedeniyle yaralanma. ▶ Bileşenleri düşmeye karşı emniyete alın.
---	---

	<b>DİKKAT!</b> <b>Vidaların gevşetilmesi nedeniyle parçaların düşme tehlikesi!</b> Cihazın diğer parçalarında veya müşterinin evinde (örn. zemin) hasarlar. ▶ Bileşenleri düşmeye karşı emniyete alın.
--	---

	<b>TEHLİKE</b> <b>Gerilim ileten parçalar nedeniyle elektrik çarpması tehlikesi!!</b> Onarımın düzgün yapılmaması nedeniyle elektrik çarpması sonucu hayati tehlike ▶ Elektrikli parçaların onarımı kalifiye bir elektrik uzmanı tarafından gerçekleştirilmelidir. ▶ Onarım sonrasında VDE 0701 veya ülkeye özel düzenlemeler uyarınca bir güvenlik testi gerçekleştirilmelidir.
---	--

	<b>TEHLİKE</b> <b>Gerilim ileten parçalar nedeniyle elektrik çarpması tehlikesi!!</b> Elektrik çarpması sebebiyle ölüm ▶ Onarıma başlamadan önce cihazın elektrik şebeke bağlantısını en az 60 saniye süreyle sökün.
---	---

Ön kontrol:

-  Cihazın fişi çekilir.
-  Cihazın iç donanımları çıkartılmıştır.

#### 4.5.1 Kapı menteşesinin sökülmesi

1. Cihazı arka tarafına yatırın.

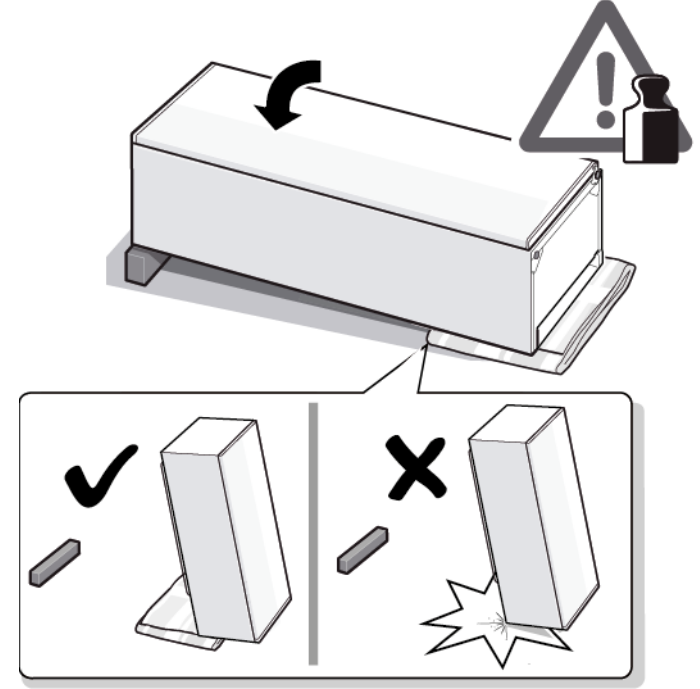



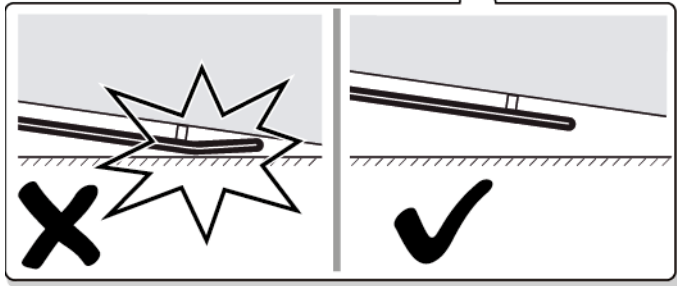
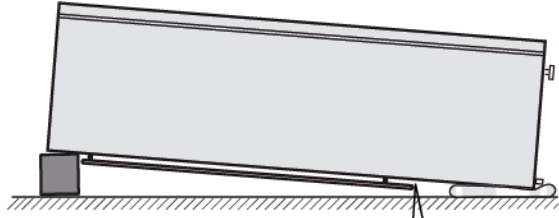

1. Üst menteşe kapağını iki tarafta da bastırın (1).
2. Üst menteşe kapağını çıkartın (2).
3. Üst menteşe kapağını sökün (3).

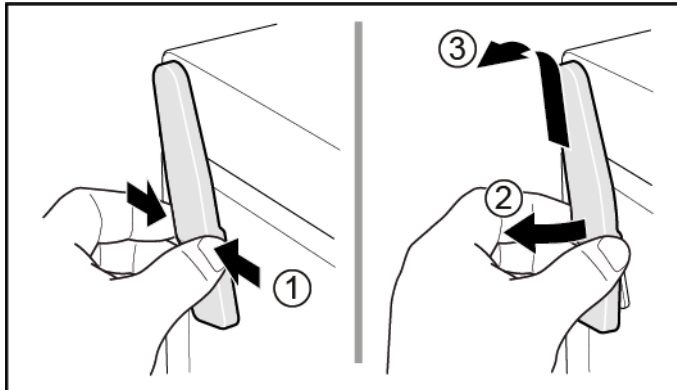

1. Kablo kutusu kapağını çıkartın (1).
2. Kablo korumasını çıkartın (2).
3. Elektrik kablo/soket bağlantısını sökünüz (3).
4. Vidaları sökün (4).
5. Üst menteşeyi çıkartın (5).

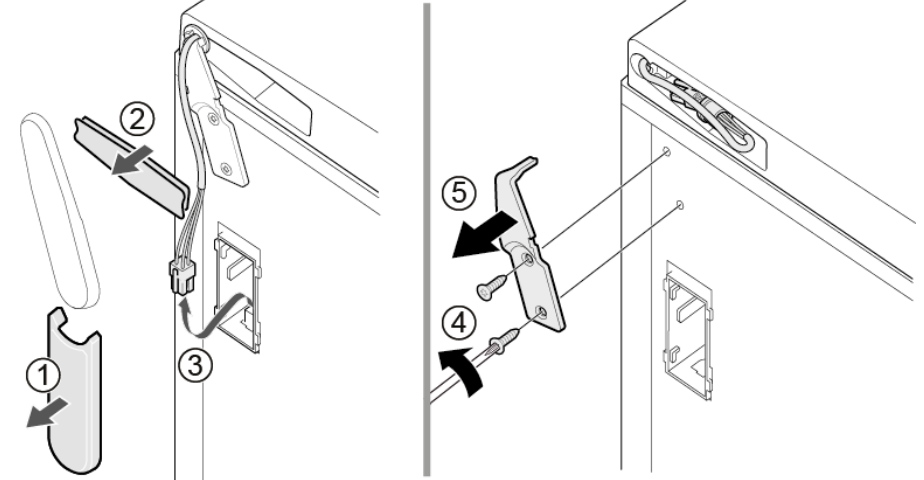

➡ Kapının üst menteşesi çıkartılmıştır.

## 4.5.2 Kapı menteşesinin takılması

- Ters sıra ile monte edin.

## 4.6 Kapının alt menteşesinin değiştirilmesi

Özel yardımcı ekipman:

Torx Bit TX20

6,3 mm (1/4")

[00340865]

	<b>UYARI</b> <b>Ağır, büyük cihazlar!</b> Sırt ve kas yaralanmaları ▶ Cihaz kapısını çıkarma işlemi sadece eğitimli uzmanlar tarafından gerçekleştirilmelidir. ▶ Cihazı hareket ettirmek için iki kişi gereklidir. ▶ Sadece uygun aletler ve ekipmanlar kullanın.
--	--

	<b>DİKKAT</b> <b>Keskin köşeler!</b> Kesik yaralanmaları ▶ Koruyucu eldiven kullanılmalıdır.
--	---

	<b>UYARI</b> <b>Eğilmiş cihazların kayması!</b> Kemik kırılmaları / çarpma sonucu yaralanmalar ▶ Cihazları kaymaya karşı emniyete alın.
--	--

	<b>DİKKAT</b> <b>Vidaların gevşetilmesi nedeniyle parçaların düşme tehlikesi!</b> Düşen parçalar nedeniyle yaralanma. ▶ Bileşenleri düşmeye karşı emniyete alın.
---	---

	<b>DİKKAT!</b> <b>Vidaların gevşetilmesi nedeniyle parçaların düşme tehlikesi!</b> Cihazın diğer parçalarında veya müşterinin evinde (örn. zemin) hasarlar. ▶ Bileşenleri düşmeye karşı emniyete alın.
--	---

Ön koşul:

- ✓ Cihazın fişi çekilir.
- ✓ Cihazın iç donanımları çıkartılmıştır.
- ✓ Cihaz arka tarafına yatırılmıştır.
- ✓ Üst menteşe çıkarılır. → 535

### 4.6.1 Kapının alt menteşesinin değiştirilmesi

1. Kapıyı sökün.

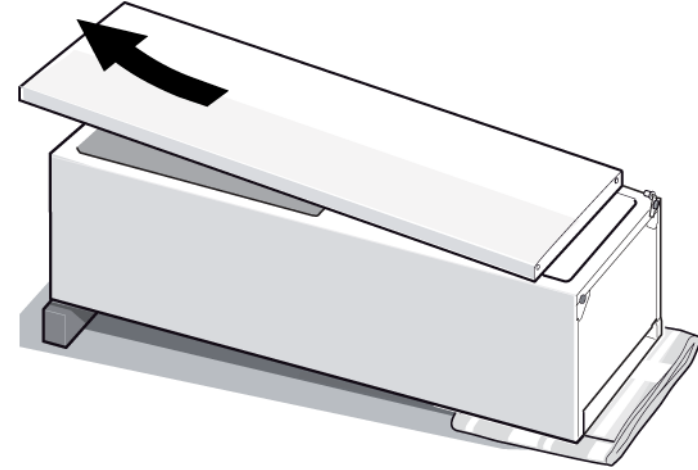

2. 1. Vidayı sökün (1).  
2. Alt menteşeyi (2) çevirin.  
3. Alt menteşeyi (3) çıkarın.

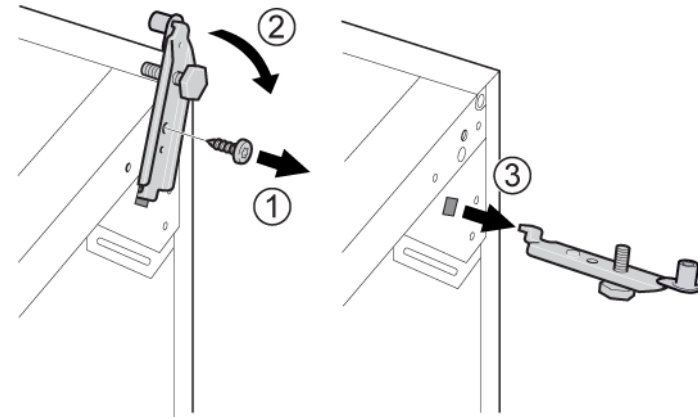

➡ Alt menteşe çıkartılmıştır.

### 4.6.2 Kapının alt menteşesinin takılması

- ▶ Ters sıra ile monte edin.

## 4.7 Raf yüzeyinin değiştirilmesi

Ön koşul:

- ✔ Kapı açık.

### 4.7.1 Raf yüzeyinin çıkartılması

- ▶ Raf yüzeyini dışarı çekin.

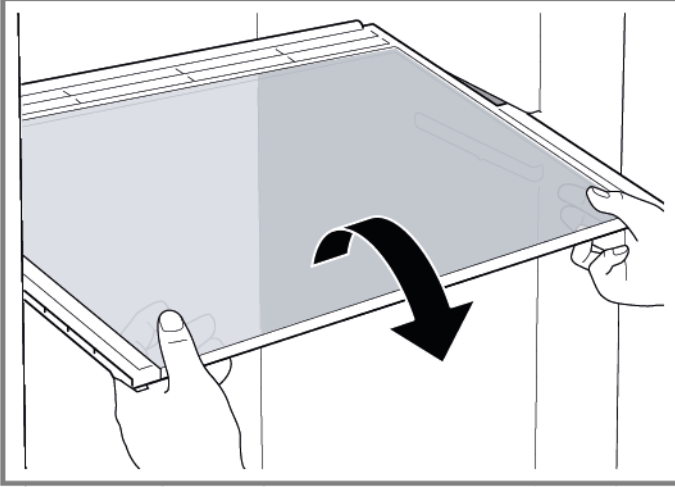

- ➡ Raf yüzeyi çıkartılmıştır.

### 4.7.2 Raf yüzeyinin takılması

- ▶ Ters sıra ile monte edin.

## 4.8 Dondurulacak gıda kabının deęiştirilmesi

Ön koşul:

- ✓ Kapı açık.

### 4.8.1 Dondurulacak gıda kabının çıkartılması

- ▶ 1. Dondurulacak gıda kabını tamamen dışarı çekin (1).
- ▶ 2. Dondurulacak gıda kabını çıkartın (2).

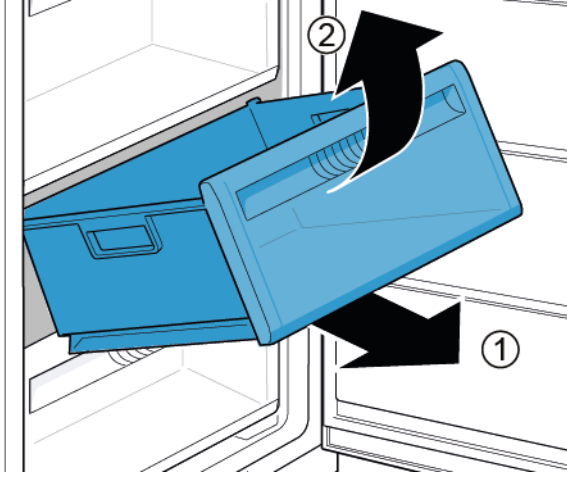

➡ Dondurulacak gıda kabı çıkartılmıştır.

### 4.8.2 Dondurulacak gıda kabının takılması

- ▶ Ters sıra ile monte edin.

## 4.9 Buzmatiğın deęiřtirilmesi

Ön koşul:

- ✓ Kapı açık.

### 4.9.1 Buzmatiğın çıkartılması

- ▶ 1. Dondurulacak gıda kabının raf yüzeyini buzmatik ile birlikte dışarı çekin (1).
- ▶ 2. Kancaları açın (2).
- ▶ 3. Buzmatiği çıkartın (3).

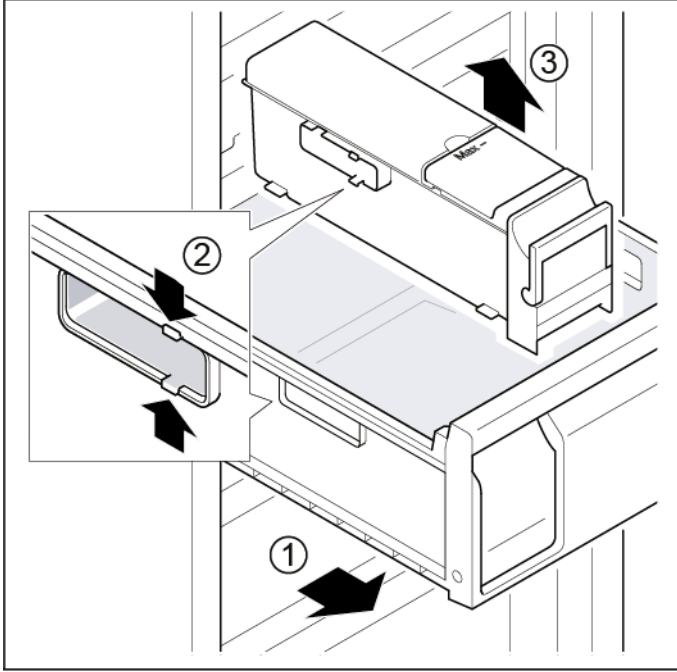

➡ Buzmatik çıkartılmıştır.

### 4.9.2 Buzmatiğın takılması

- ▶ Ters sıra ile monte edin.

## 4.10 LED Üst aydınlatmanın değiştirilmesi

Özel yardımcı ekipman:

 Düz tornavida

Bıçak 2,4 mm x 0,4 mm x 60 mm,  
[00341820] numaralı kit içinde



Cihazınızda bakım gerektirmeyen bir LED ışık bulunmaktadır. Bu ışıklar sadece müşteri hizmetleri veya yetkili teknisyenler tarafından değiştirilebilir!



### TEHLİKE

**Gerilim ileten parçalar nedeniyle elektrik çarpması tehlikesi!!**

Onarımın düzgün yapılmaması nedeniyle elektrik çarpması sonucu hayati tehlike

- ▶ Elektrikli parçaların onarımı kalifiye bir elektrik uzmanı tarafından gerçekleştirilmelidir.
- ▶ Onarım sonrasında VDE 0701 veya ülkeye özel düzenlemeler uyarınca bir güvenlik testi gerçekleştirilmelidir.



### TEHLİKE

**Gerilim ileten parçalar nedeniyle elektrik çarpması tehlikesi!!**

Elektrik çarpması sebebiyle ölüm

- ▶ Onarıma başlamadan önce cihazın elektrik şebeke bağlantısını en az 60 saniye süreyle sökün.





### DİKKAT

**Keskin köşeler!**

Kesik yaralanmaları

- ▶ Koruyucu eldiven kullanılmalıdır.

Ön koşul:

-  Cihazın fişi çekilir.
-  Kapı açık.
-  Üst iç donanımlar çıkartılmıştır.

### 4.10.1 LED Lambanın sökülmesi

1. LED Lambayı sol tarafa kaydırın.

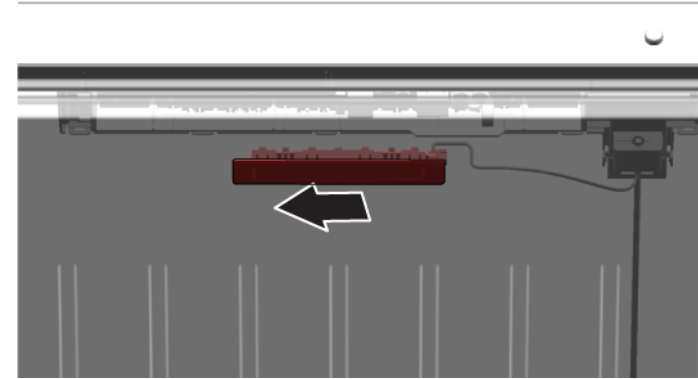

-  LED ışığının elektrik bağlantısı ayrıldı.

2. LED ışığını tırnaklarından kurtarın.

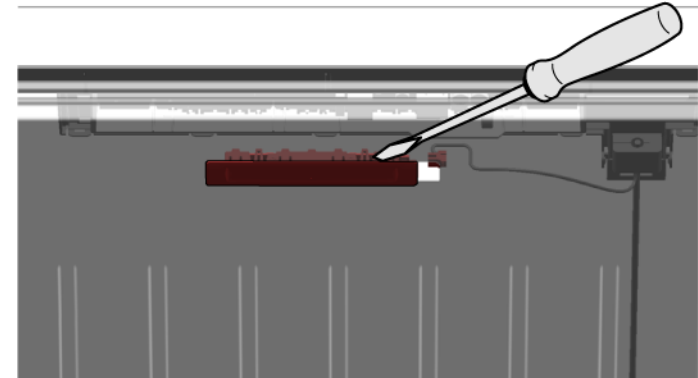

3. LED ışığını ileri hareket ettirerek sökün.

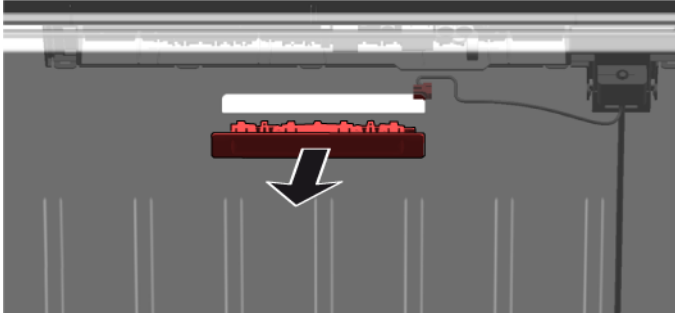

 LED ışığı söküldü.

### 4.10.2 Üst LED ışığının takılması

► Ters sıra ile monte edin.