

W6 OM5 4S H

12NC: 859991541570

GTIN (EAN) code: 8003437834523

Whirlpool

SENSING THE DIFFERENCE

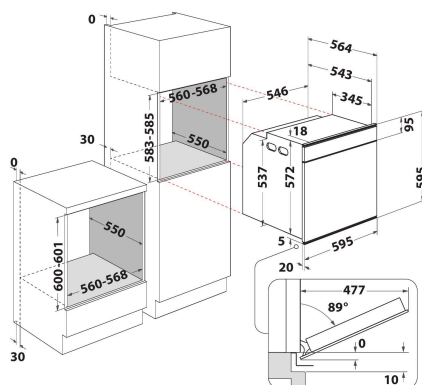

MAIN FEATURES

Product group	Oven
Commercial code	W6 OM5 4S H
Main colour of product	ИНОКС
Construction type	Built-in
Type of control	Electronic
Type of control settings	-
Are any hobs controls integrated?	No
Which kind of hobs can be controlled?	-
Automatic programmes	Yes
Current (A)	16
Voltage (V)	220-240
Frequency (Hz)	50/60
Length of Electrical Supply Cord (cm)	90
Plug type	No
Depth with open door 90 degree (mm)	-
Height of the product	595
Width of the product	595
Depth of the product	564
Minimum niche height	0
Minimum niche width	0
Niche depth	0
Net weight (kg)	40.5
Usable volume (of cavity)	73
Integrated Cleaning system	Hydrolytic
Grids of the cavity	2
Trays	2

TECHNICAL FEATURES

Timer	-
Time control	Electronic
Time-setting options	Start and Stop
Safety device	-
Interior light	Yes
Number of interior lights of the cavity	1
Position of interior lights of the cavity	Rear
Oven guides of the cavity	Grids
Probe of the cavity	No

ENERGY LABEL

Energy input	Electric
Type of energy of the cavity	електрически
Energy efficiency class - NEW (2010/30/EU)	A+
Energy consumption per cycle conventional - NEW (2010/30/EU)	0.91
Energy consumption per cycle forced air convection - NEW (2010/30/EU)	0.7