



Lenovo ThinkSystem ST50 Server Product Guide

The Lenovo ThinkSystem ST50 1-socket 4U rack-mountable tower server is an entry level server ideal for small businesses, home offices, retail, educational institutions and branch offices. The server supports one Intel Xeon E-2100 Series processor (formerly codenamed "Coffee Lake") and up to 64 GB of 2666 MHz TruDDR4 ECC memory.

Figure 1 shows the Lenovo ThinkSystem ST50.



Figure 1. Lenovo ThinkSystem ST50

Did you know?

The ThinkSystem ST50 offers enterprise-class reliability features such as error correcting code (ECC) memory, the onboard RAID controller, and enterprise-class hard drives and network adapters at an affordable price. The server has Intel Active Management Technology (AMT) built-in, along with support for industry-standard management tools. The ST50 runs a wide range of server operating systems plus support for Windows 10, and is quiet enough and small enough to fit under or beside an office desk.

Key features

The ThinkSystem ST50 server is an office-friendly tower server that has been optimized to provide enterprise-class features to small businesses, retail, educational institutions and branch offices.

Scalability and performance

The ST50 offers numerous features to boost performance, improve scalability, and reduce costs:

- The Intel Xeon E-2100 Series processors improves productivity by offering affordable single-socket system performance with 6-core processors with up to 3.8 GHz core speeds.
- Intelligent and adaptive system performance with Intel Turbo Boost Technology 2.0 allows processor cores to run at maximum speeds during peak workloads by temporarily going beyond processor thermal design power (TDP).
- Intel Hyper-Threading Technology boosts performance for multithreaded applications by enabling simultaneous multithreading within each processor core, up to two threads per core.
- Intel Virtualization Technology integrates hardware-level virtualization hooks that allow operating system vendors to better use the hardware for virtualization workloads.
- Up to four 2666 MHz DDR4 ECC or non-ECC UDIMMs provide speed and capacity of up to 64 GB.
- The server offers PCI Express 3.0 I/O expansion capabilities that increase the theoretical maximum bandwidth by almost 100% (8 GTps per link using 128b/130b encoding) compared to the PCI Express 2.0 (5 GTps per link using 8b/10b encoding).
- With Intel Integrated I/O Technology, the PCI Express 3.0 controller is integrated into the Intel Xeon E-2100 Series processors. Such integration reduces I/O latency and increases overall system performance.
- Up to four non-hot-swap (NHS) drive bays supporting hard disk drives (HDDs) or solid-state drives (SSDs) provide flexible internal storage capacity.
- The use of SSDs instead of, or along with, traditional spinning drives (hard disk drives or HDDs) can significantly improve I/O performance.

Availability and serviceability

The ST50 provides many features to simplify serviceability and increase system uptime:

- The ST50 supports UDIMM memory with ECC protection which provides error correction not available in PC-class "servers" that use parity memory. Avoiding system crashes (and data loss) due to soft memory errors means greater system uptime.
- Tool-less cover removal provides easy access to upgrades and serviceable parts, such as memory and adapter cards.
- A choice of affordable onboard SATA RAID or advanced hardware RAID redundancy offers data protection and greater system uptime.
- The use of SSDs can provide better reliability than the use of traditional HDDs, for greater uptime.
- Built-in Active Management Technology based on Intel Active Management Technology (AMT) 12.0 which continuously monitors system parameters, sends alerts, and enables administrators to perform remote recovery actions to minimize downtime.
- The Lenovo XClarity Provisioning Manager Lite tool can be used to install an operating system on the server and perform system diagnostics.
- One-year or three-year customer-replaceable unit (CRU) and onsite limited warranty with next business day response. Optional service upgrades are available.

Manageability and security

Powerful systems management features simplify local and remote management of the ST50:

- Intel Active Management Technology (AMT) 12.0 monitors server availability and enables administrators to perform remote management.
- An integrated industry-standard Unified Extensible Firmware Interface (UEFI) enables improved setup, configuration, and updates, and simplifies error handling.
- An integrated hardware Trusted Platform Module (TPM) supporting TPM 2.0 and 1.2 enables advanced cryptographic functionality, such as digital signatures and remote attestation.
- Protects application code and data from disclosure or modification with Intel Software Guard Extensions (SGX), enabling high-assurance security use cases, such as blockchain, identity and records privacy, secure browsing, and digital rights management (DRM).
- Administrator and power-on passwords help protect from unauthorized access to the server.
- An intrusion switch on the cover of the server and padlock loop at the rear of the server help detect and prevent unauthorized physical access to the internal components of the server .
- A slot for a Kensington-style cable lock helps prevent theft.

Energy efficiency

The ST50 offers the following energy-efficiency features to save energy, reduce operational costs, increase energy availability, and contribute to a green environment:

- 80 PLUS Platinum-certified power supply (select models) enables greater energy savings while providing flexibility to meet your business needs.
- Intelligent Cooling Engine (ICE) actively monitors component temperatures in real-time and optimally adjusts the speeds of the fans to keep the system cooler and quieter.
- The ThinkSystem Capacity Planner tool provides information about the power consumption and electric current calculation for the different configurations of servers and other devices, which helps plan deployment of servers and devices in an efficient way.
- Intel Intelligent Power Capability powers individual processor elements on and off as needed, to reduce power draw.

Components and connectors

The following figure shows the front of the server.

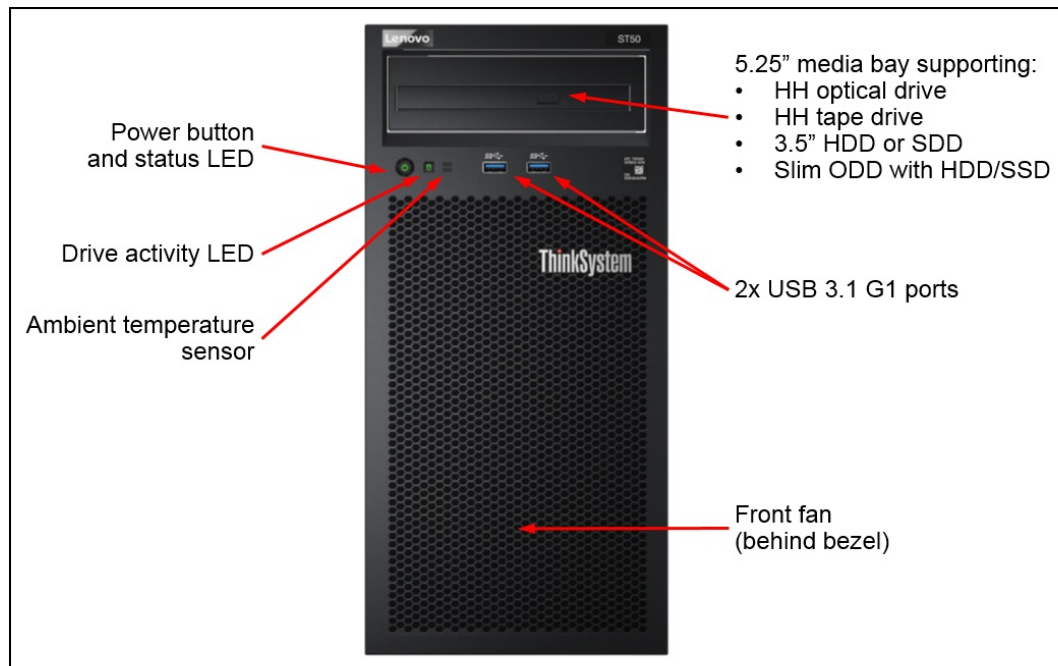

Figure 2. Front view of the ThinkSystem ST50 server

The following figure shows the rear of the server.

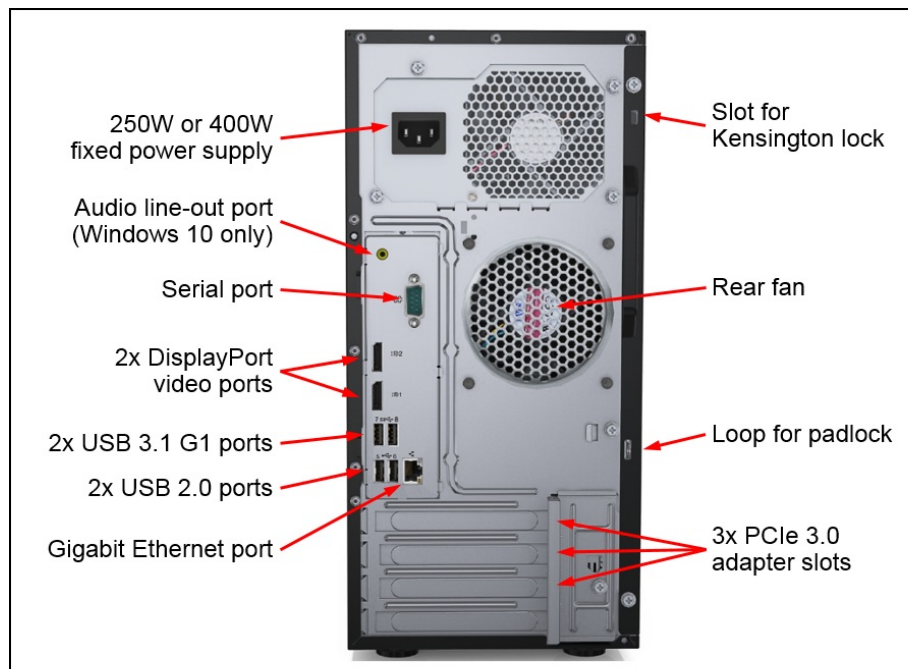

Figure 3. Rear view of the ThinkSystem ST50 server

The following figure shows the locations of key components inside the server.

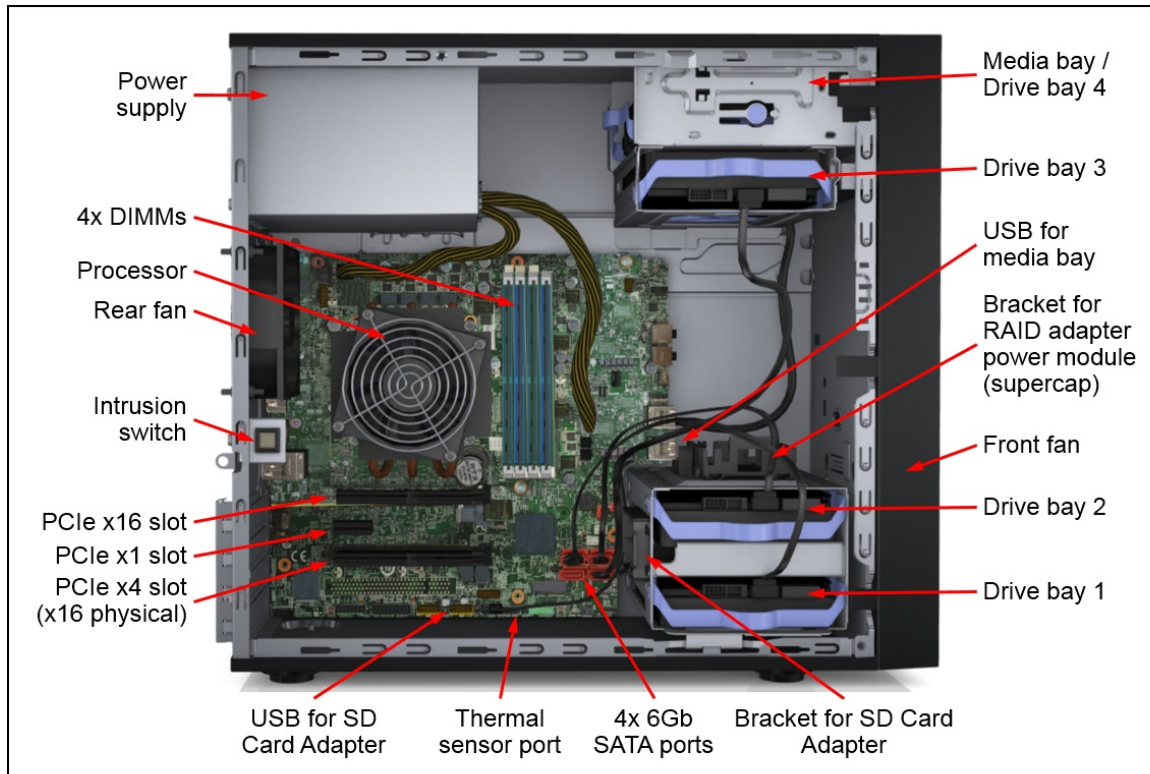

Figure 4. Internal view of the ThinkSystem ST50 server

System architecture

The following figure shows the architectural block diagram of the ST50, showing the major components and their connections.

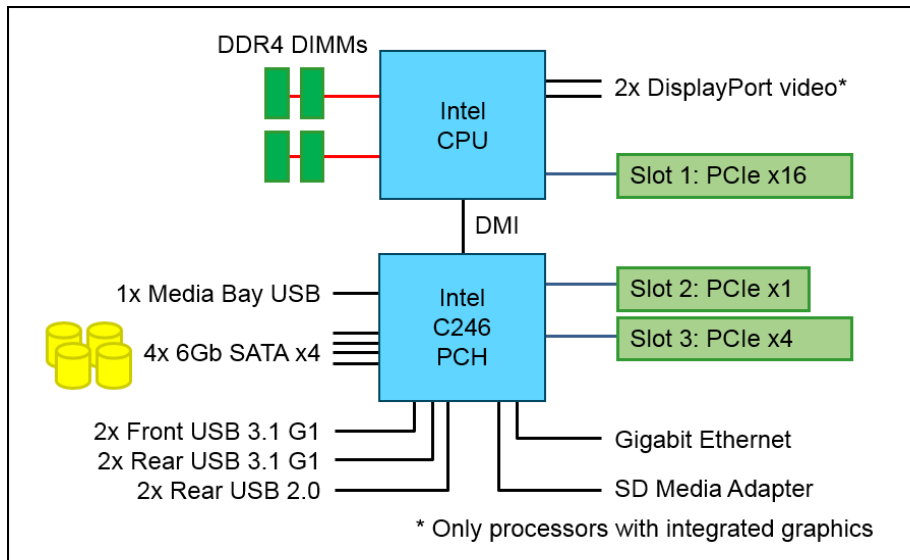

Figure 5. ST50 system architectural block diagram

Standard specifications

The following table lists the standard specifications.

Table 1. Standard specifications

Components	Specification
Machine type	7Y49 - 1 year warranty 7Y48 - 3 year warranty
Form factor	Tower or 4U rack
Processor	One Intel processor (formerly codenamed "Coffee Lake"). Choose from: <ul style="list-style-type: none"> • Intel Xeon E-2100 Series processor up to 3.8 GHz • Intel Core i3-8100/8300 Series processor up to 4 GHz • Intel Pentium G5400/G5500/G5600 Series processor up to 3.9 GHz • Intel Celeron G4900 Series processor up to 3.2 GHz
Chipset	Intel C246 chipset
Memory	Four DIMM sockets supporting Lenovo TruDDR4 DIMMs at 2666 MHz. Support ECC UDIMMs. For China customers, the server supports non-ECC DIMMs (ECC and non-ECC cannot be mixed).
Memory maximums	Up to 64 GB with 4x 16 GB UDIMMs
Memory protection	Error-correcting code (ECC)
Disk drive bays	Up to 4x 3.5-inch non-hot swap (NHS) drive bays. Bays 1-3 only support 3.5" HDD or SSD drives; Bay 4 supports one of the following configurations: <ul style="list-style-type: none"> • 3.5-inch non-hot-swap HDD or SSD in a 5.25-inch conversion tray • Half-high optical drive (either DVD-ROM or DVD-RW) • Half-high backup unit (either LTO tape or RDX drive) • Combination 3.5-inch non-hot-swap HDD or SSD plus a slim optical DVD-RW <p>The server can be configured without any HDDs or SSDs. The server also supports 2x SD Cards installed in an optional SD Card Adapter (RAID not supported).</p>
Maximum internal storage	<ul style="list-style-type: none"> • Using HDDs: 32 TB using 4x 8TB SATA HDDs • Using SSDs: 3.84 TB using 4x 960GB SATA SSDs <p>HDDs and SSDs can be installed in the same server but are not supported in the same RAID volume</p>
Storage controller	<ul style="list-style-type: none"> • Onboard 6 Gb SATA controller, supporting AHCI mode (non-RAID) or Intel RSTe software RAID (RAID 0, 1, 10, 5) • 12 Gb RAID controller: <ul style="list-style-type: none"> ◦ RAID 530i (cacheless) supports RAID 0, 1, 10, 5 ◦ RAID 730-8i with 1GB cache supports RAID 0, 1, 10, 5 ◦ RAID 930-8i with 2GB flash-backed cache supports RAID 0, 1, 10, 5, 6 • 12 Gb Host Bus Adapter: <ul style="list-style-type: none"> ◦ 430-8i SAS/SATA 12Gb HBA
Media drive bay	One half-height 5.25-inch bay for optical or tape drive. Supports DVD-ROM or DVD-RW. Mutually exclusive with the fourth HDD/SSD.

Components	Specification
Network interfaces	One integrated Gigabit Ethernet 1000BASE-T port (RJ-45) using Intel i219-LM controller.
PCI Expansion slots	Three PCIe slots as follows: <ul style="list-style-type: none"> Slot 1: PCIe 3.0 x16 full-height half-length (FHHL) Slot 2: PCIe 3.0 x1 full-height half-length (FHHL) Slot 3: PCIe 3.0 x4 (physical connector is x16) full-height half-length (FHHL)
Ports	Front ports: <ul style="list-style-type: none"> Two USB ports (both are USB 3.1 G1) Rear ports: <ul style="list-style-type: none"> Four USB ports (two USB 3.1 G1, two USB 2.0) Two DisplayPort video ports (require a processor with integrated graphics) One RJ-45 Gigabit Ethernet port One serial port One audio line-out ports (Windows 10 only; some line noise is possible)
Cooling	Supports ASHRAE A2 and ASHRAE B environments. Two fixed system fans. Additional fans attached to the processor, in the power supply, and in the optional media bay enclosure.
Power supply	One fixed power supply, either 250W or 400W power supply. 80 PLUS Platinum certified.
Hot-swap parts	None
Systems management	Power and drive activity LEDs. Intel Active Management Technology (AMT) 12.0 server management. Supports Integrated Lenovo XClarity Provisioning Manager Lite (USB memory key-based) for system setup and firmware upgrades. No support for XClarity Controller (XCC).
Security features	Power-on password, administrator's password, Trusted Platform Module (TPM), supporting TPM 1.2 or TPM 2.0. Optional Chassis intrusion switch. Padlock loop and Kensington cable slot for physical security.
Video	Integrated Intel Graphics Technology (Intel GT) on most processors - see the Processors section. Two DisplayPort ports. Maximum resolution is 3840 x 2160 pixels (4K) at a refresh rate of 60Hz. On servers with a processor that does not have integrated graphics, the two DP ports are not connected and a separate GPU adapter is required. See GPU adapters for details.
Operating systems supported	Microsoft Windows Server, Red Hat Enterprise Linux, VMware ESXi. See the Operating system support section for specifics.
Limited warranty	Three-year or one-year (model dependent) customer-replaceable unit and onsite limited warranty with 9x5 next business day (NBD).
Service and support	Optional service upgrades are available through Lenovo Services: 4-hour or 2-hour response time, 6-hour fix time, 1-year or 2-year warranty extension, software support for Lenovo hardware and some third-party applications.
Dimensions	Height: 375 mm (14.8 in), width: 175 mm (6.9 in), depth: 407 mm (16.0 in)
Weight	Minimum: 7.5 kg (16.5 lb), maximum: 11.2 kg (24.7 lb)

The ST50 server is shipped with the following items:

- Documentation flyer
- Power cord (model and region dependent)

Models

The following tables list the available models, grouped by region.

- [Models for Australia and New Zealand](#)
- [Models for South East Asian countries \(ASEAN\)](#)
- [Models for Brazil](#)
- [Models for EMEA countries](#)
- [Models for Hong Kong, Taiwan, Korea \(HTK\)](#)
- [Models for Japan](#)
- [Models for Latin American countries \(except Brazil\)](#)
- [Models for USA and Canada](#)

Refer to the Specifications section for information about standard features of the server.

Models for Australia and New Zealand

Table 2. Models for Australia and New Zealand

Model	Intel processor†	Memory	Drive Controller	Drive bays Drives	Media bay	GPU	Power supply & cord	Intru sw.	Op Sys
Standard models with a 1-year warranty (machine type 7Y49)									
7Y49A012AU	Xeon E-2124G 4+2C 71W 3.4GHz	1x 8GB	Onboard AHCI	3 drive bays Open bay	Open	Option	400W Yes	Opt	Not incl.
7Y49A01GAU	Xeon E-2126G 6+2C 80W 3.3GHz	1x 8GB	Onboard AHCI	3 drive bays Open bay	Open	No	250W Yes	Opt	Not incl.
7Y49A019AU	Xeon E-2136 6C 80W 3.3GHz	1x 8GB	Onboard AHCI	3 drive bays Open bay	Open	P620	400W Yes	Opt	Not incl.
7Y49A01PAU	Xeon E-2144G 4+2C 71W 3.6GHz	1x 8GB	Onboard AHCI	4 drive bays Open bay	Slim DVD-RW + 3.5-in bay	No	250W Yes	Opt	Not incl.
7Y49A01UAU	Xeon E-2174G 4+2C 71W 3.8GHz	1x 16GB	Onboard AHCI	3 drive bays Open bay	Open	No	250W Yes	Opt	Not incl.
7Y49A00PAU	Xeon E-2176G 6+2C 80W 3.7GHz	1x 16GB	Onboard AHCI	4 drive bays Open bay	Slim DVD-RW + 3.5-in bay	No	250W Yes	Opt	Not incl.
7Y49A00SAU	Xeon E-2186G 6+2C 95W 3.8GHz	1x 16GB	Onboard AHCI	3 drive bays Open bay	Open	No	250W Yes	Opt	Not incl.
7Y49A01RAU	Pentium G5600 2C+2 54W 3.9GHz	1x 8GB	Onboard AHCI	3 drive bays Open bay	Open	No	250W Yes	Opt	Not incl.
TopSeller models with a 1-year warranty (machine type 7Y49)									
7Y49A01JAU	Xeon E-2104G 4+2C 65W 3.2GHz	1x 8GB	Onboard AHCI	3 drive bays Open bay	Open	No	250W Yes	Opt	Not incl.
7Y49A00WAU	Xeon E-2124G 4+2C 71W 3.4GHz	1x 8GB	Onboard AHCI	3 drive bays Open bay	Open	No	250W Yes	Opt	Not incl.
7Y49A01KAU	Xeon E-2146G 6+2C 80W 3.5GHz	1x 8GB	Onboard AHCI	3 drive bays Open bay	Open	No	250W Yes	Opt	Not incl.
7Y49A014AU	Core i3-8300 4C+2 62W 3.7GHz	1x 8GB	Onboard AHCI	3 drive bays Open bay	Open	No	250W Yes	Opt	Not incl.

† Processor detail: Model, compute core count + graphics core count, TDP, core frequency

Models for South East Asian countries (ASEAN)

Table counter name="table". Models for South East Asian countries (ASEAN)

Model	Intel processors†	Memory	Drive Controller	Drive bays Drives	Media bay	GPU	Power supply & cord	Intru sw.	Op Sys
TopSeller models with a 3-year warranty (machine type 7Y48)									
7Y48A00ASG	Xeon E-2104G 4+2C 65W 3.2GHz	1x 8GB	Onboard RSTe	3 drive bays 1x 1TB HDD	HH DVD-ROM	No	250W No	Opt	Not incl.
7Y48A00DSG	Xeon E-2104G 4+2C 65W 3.2GHz	1x 8GB	Onboard RSTe	3 drive bays 1x 1TB HDD	HH DVD-RW	Option	400W No	Opt	Not incl.
7Y48A00PSG	Xeon E-2124G 4+2C 71W 3.4GHz	1x 8GB	Onboard RSTe	3 drive bays 1x 1TB HDD	HH DVD-RW	Option	400W No	Opt	Not incl.
7Y48A01NSG	Xeon E-2124G 4+2C 71W 3.4GHz	1x 8GB	Onboard RSTe	3 drive bays 1x 1TB HDD	HH DVD-ROM	No	250W No	Opt	Not incl.
7Y48A00CSG	Xeon E-2126G 6+2C 80W 3.3GHz	1x 8GB	Onboard RSTe	3 drive bays 1x 1TB HDD	HH DVD-RW	Option	400W No	Opt	Not incl.
7Y48A01JSG	Xeon E-2126G 6+2C 80W 3.3GHz	1x 8GB	Onboard RSTe	3 drive bays 1x 1TB HDD	HH DVD-ROM	No	250W No	Opt	Not incl.
7Y48A01ASG	Xeon E-2144G 4+2C 71W 3.6GHz	1x 8GB	Onboard RSTe	3 drive bays 1x 1TB HDD	HH DVD-ROM	No	250W No	Opt	Not incl.
7Y48A01HSG	Xeon E-2144G 4+2C 71W 3.6GHz	1x 8GB	Onboard RSTe	3 drive bays 1x 1TB HDD	HH DVD-RW	Option	400W No	Opt	Not incl.
7Y48A01LSG	Xeon E-2146G 6+2C 80W 3.5GHz	1x 8GB	Onboard RSTe	3 drive bays 1x 1TB HDD	HH DVD-ROM	No	250W No	Opt	Not incl.
7Y48A01MSG	Xeon E-2146G 6+2C 80W 3.5GHz	1x 8GB	Onboard RSTe	3 drive bays 1x 1TB HDD	HH DVD-RW	Option	400W No	Opt	Not incl.
7Y48A00WSG	Xeon E-2174G 4+2C 71W 3.8GHz	1x 8GB	Onboard RSTe	3 drive bays 1x 1TB HDD	HH DVD-ROM	No	250W No	Opt	Not incl.
7Y48A01KSG	Xeon E-2174G 4+2C 71W 3.8GHz	1x 8GB	Onboard RSTe	3 drive bays 1x 1TB HDD	HH DVD-RW	Option	400W No	Opt	Not incl.

† Processor detail: Model, compute core count + graphics core count, TDP, core frequency

Models for Brazil

Table 3. Models for Brazil

Model	Intel processors†	Memory	Drive Controller	Drive bays Drives	Media bay	GPU	Power supply & cord	Intru sw.	Op Sys
TopSeller models with a 3-year warranty (machine type 7Y48)									
7Y48A010BR	Xeon E-2104G 4+2C 65W 3.2GHz	1x 16GB	Onboard RSTe	3 drive bays 2x 1TB HDD	HH DVD- RW	No	250W Yes	Yes	Not incl.
7Y48A014BR	Xeon E-2104G 4+2C 65W 3.2GHz	1x 16GB	Onboard RSTe	3 drive bays 1x 1TB HDD	HH DVD- RW	No	250W Yes	Yes	Not incl.
7Y48A017BR	Xeon E-2104G 4+2C 65W 3.2GHz	1x 16GB	Onboard RSTe	3 drive bays 2x 2TB HDD	HH DVD- RW	No	250W Yes	Yes	Not incl.
7Y48A01FBR	Xeon E-2104G 4+2C 65W 3.2GHz	1x 16GB	Onboard RSTe	3 drive bays 1x 2TB HDD	HH DVD- RW	No	250W Yes	Yes	Not incl.
7Y48A00LBR	Xeon E-2104G 4+2C 65W 3.2GHz	1x 8GB	Onboard RSTe	3 drive bays 1x 1TB HDD	HH DVD- RW	No	250W Yes	Yes	Not incl.
7Y48A00TBR	Xeon E-2104G 4+2C 65W 3.2GHz	1x 8GB	Onboard RSTe	3 drive bays 2x 2TB HDD	HH DVD- RW	No	250W Yes	Yes	Not incl.
7Y48A018BR	Xeon E-2104G 4+2C 65W 3.2GHz	1x 8GB	Onboard RSTe	3 drive bays 2x 1TB HDD	HH DVD- RW	No	250W Yes	Yes	Not incl.
7Y48A01EBR	Xeon E-2104G 4+2C 65W 3.2GHz	1x 8GB	Onboard RSTe	3 drive bays 1x 2TB HDD	HH DVD- RW	No	250W Yes	Yes	Not incl.
7Y48A01WBR	Xeon E-2104G 4+2C 65W 3.2GHz	1x 8GB	Onboard RSTe	3 drive bays 1x 1TB HDD	HH DVD- RW	No	250W Yes	Opt	WS19 Ess Drop
7Y48A01XBR	Xeon E-2104G 4+2C 65W 3.2GHz	1x 8GB	Onboard RSTe	3 drive bays 1x 1TB HDD	HH DVD- RW	No	250W Yes	Opt	WS19 Std Drop
Standard models with a 1-year warranty (machine type 7Y49)									
7Y491003BR	Xeon E-2104G 4+2C 65W 3.2GHz	1x 8GB	Onboard RSTe	3 drive bays 1x S4510 480GB	HH DVD- RW	No	250W Yes	Yes	Not incl.
7Y491007BR	Xeon E-2104G 4+2C 65W 3.2GHz	1x 8GB	Onboard RSTe	3 drive bays 1x S4510 960GB	HH DVD- RW	No	250W Yes	Yes	Not incl.

† Processor detail: Model, compute core count + graphics core count, TDP, core frequency

Models for EMEA countries

Table 4. Models for EMEA countries

Model	Intel processors†	Memory	Drive Controller	Drive bays Drives	Media bay	GPU	Power supply & cord	Intru sw.	Op Sys
Standard models with a 3-year warranty (machine type 7Y48)									
7Y48A003EA	Xeon E-2124G 4+2C 71W 3.4GHz	1x 8GB	Onboard AHCI	4 drive bays 1x 1TB HDD	Slim DVD-RW + 3.5-in bay	No	250W No	Opt	Not incl.
7Y48A006EA	Xeon E-2124G 4+2C 71W 3.4GHz	1x 8GB	Onboard AHCI	4 drive bays 2x 1TB HDD	Slim DVD-RW + 3.5-in bay	No	250W No	Opt	Not incl.
7Y48A007EA	Xeon E-2124G 4+2C 71W 3.4GHz	1x 8GB	Onboard AHCI	4 drive bays 2x 2TB HDD	Slim DVD-RW + 3.5-in bay	No	250W No	Opt	Not incl.
7Y48A008EA	Xeon E-2124G 4+2C 71W 3.4GHz	1x 8GB	Onboard AHCI	4 drive bays Open bay	Slim DVD-RW + 3.5-in bay	No	250W No	Opt	Not incl.
7Y48A00ZEA	Xeon E-2124G 4+2C 71W 3.4GHz	1x 8GB	Onboard AHCI	4 drive bays 2x 4TB HDD	Slim DVD-RW + 3.5-in bay	No	250W No	Opt	Not incl.
7Y48A00HEA	Xeon E-2126G 6+2C 80W 3.3GHz	1x 8GB	Onboard AHCI	4 drive bays 2x 4TB HDD	Slim DVD-RW + 3.5-in bay	No	250W No	Opt	Not incl.
7Y48A02BEA	Xeon E-2126G 6+2C 80W 3.3GHz	1x 8GB	Onboard AHCI	4 drive bays 2x 1TB HDD	Slim DVD-RW + 3.5-in bay	No	250W No	Opt	Not incl.
7Y48A02DEA	Xeon E-2126G 6+2C 80W 3.3GHz	1x 16GB	Onboard AHCI	3 drive bays 2x 2TB HDD	Open	No	250W No	Opt	Not incl.
7Y48A02CEA	Xeon E-2144G 4+2C 71W 3.6GHz	1x 8GB	Onboard AHCI	4 drive bays 2x 1TB HDD	Slim DVD-RW + 3.5-in bay	No	250W No	Opt	Not incl.
7Y48A00BEA	Xeon E-2146G 6+2C 80W 3.5GHz	1x 8GB	Onboard AHCI	4 drive bays Open bay	Slim DVD-RW + 3.5-in bay	No	250W No	Opt	Not incl.
7Y48A001EA	Xeon E-2176G 6+2C 80W 3.7GHz	1x 16GB	Onboard AHCI	4 drive bays Open bay	Slim DVD-RW + 3.5-in bay	No	250W No	Opt	Not incl.
Standard models with a 1-year warranty (machine type 7Y49)									
7Y49A01NEA	Xeon E-2124G 4+2C 71W 3.4GHz	1x 8GB	Onboard AHCI	4 drive bays 2x 1TB HDD	Slim DVD-RW + 3.5-in bay	No	250W No	Opt	Not incl.

† Processor detail: Model, compute core count + graphics core count, TDP, core frequency

Models for Hong Kong, Taiwan, Korea (HTK)

Included with all Hong Kong, Taiwan, Korea models:

- 1x ThinkSystem ST50 DP to VGA Dongle Kit

Table 5. Models for Hong Kong, Taiwan, Korea (HTK)

Model	Intel processors†	Memory	Drive Controller	Drive bays Drives	Media bay	GPU	Power supply & cord	Intru sw.	Op Sys
TopSeller models with a 3-year warranty (machine type 7Y48)									
7Y48A00ACN	Xeon E-2104G 4+2C 65W 3.2GHz	1x 8GB	Onboard RSTe	3 drive bays 1x 1TB HDD	HH DVD-ROM	No	250W No	Opt	Not incl.
7Y48A00DCN	Xeon E-2104G 4+2C 65W 3.2GHz	1x 8GB	Onboard RSTe	3 drive bays 1x 1TB HDD	HH DVD-RW	Option	400W No	Opt	Not incl.
7Y48A01DCN	Xeon E-2104G 4+2C 65W 3.2GHz	1x 8GB	Onboard AHCI	3 drive bays Open bay	HH DVD-RW	Option	400W No	Opt	Not incl.
7Y48A00PCN	Xeon E-2124G 4+2C 71W 3.4GHz	1x 8GB	Onboard RSTe	3 drive bays 1x 1TB HDD	HH DVD-RW	Option	400W No	Opt	Not incl.
7Y48A019CN	Xeon E-2124G 4+2C 71W 3.4GHz	1x 8GB	Onboard AHCI	3 drive bays Open bay	HH DVD-ROM	No	250W No	Opt	Not incl.
7Y48A00CCN	Xeon E-2126G 6+2C 80W 3.3GHz	1x 8GB	Onboard RSTe	3 drive bays 1x 1TB HDD	HH DVD-RW	Option	400W No	Opt	Not incl.
7Y48A01ACN	Xeon E-2144G 4+2C 71W 3.6GHz	1x 8GB	Onboard RSTe	3 drive bays 1x 1TB HDD	HH DVD-ROM	No	250W No	Opt	Not incl.
7Y48A00QCN	Xeon E-2174G 4+2C 71W 3.8GHz	1x 8GB	Onboard AHCI	3 drive bays Open bay	HH DVD-ROM	No	250W No	Opt	Not incl.
7Y48A00WCN	Xeon E-2174G 4+2C 71W 3.8GHz	1x 8GB	Onboard RSTe	3 drive bays 1x 1TB HDD	HH DVD-ROM	No	250W No	Opt	Not incl.
7Y48A015CN	Xeon E-2174G 4+2C 71W 3.8GHz	1x 8GB	Onboard AHCI	3 drive bays Open bay	HH DVD-RW	Option	400W No	Opt	Not incl.

† Processor detail: Model, compute core count + graphics core count, TDP, core frequency

Models for Japan

Included with all Japan models:

- 1x ThinkSystem ST50 DP to VGA Dongle Kit
- ThinkSystem Optical Wheel Mouse - USB
- ThinkSystem Preferred Pro II USB Keyboard - Japanese

Table 6. Models for Japan

Model	Intel processors†	Memory	Drive Controller	Drive bays Drives	Media bay	GPU	Power supply & cord	Intru sw.	Op Sys
Standard models with a 1-year warranty (machine type 7Y49)									
7Y49A01WJP	Xeon E-2104G 4+2C 65W 3.2GHz	1x 8GB	Onboard AHCI	3 drive bays Open bay	HH DVD-ROM	No	250W Yes	Opt	Not incl.
7Y49A02RJP	Xeon E-2104G 4+2C 65W 3.2GHz	1x 8GB	Onboard RSTe	3 drive bays 2x 2TB HDD	HH DVD-ROM	No	250W Yes	Opt	WS19 Std Preload
7Y49A01LJP	Xeon E-2124G 4+2C 71W 3.4GHz	1x 8GB	Onboard AHCI	3 drive bays Open bay	HH DVD-ROM	No	250W Yes	Opt	Not incl.
7Y49A017JP	Xeon E-2126G 6+2C 80W 3.3GHz	1x 8GB	Onboard AHCI	3 drive bays Open bay	HH DVD-ROM	No	250W Yes	Opt	Not incl.

Model	Intel processors†	Memory	Drive Controller	Drive bays Drives	Media bay	GPU	Power supply & cord	Intru sw.	Op Sys
7Y49A01SJP	Xeon E-2144G 4+2C 71W 3.6GHz	1x 8GB	Onboard AHCI	3 drive bays Open bay	HH DVD-ROM	No	250W Yes	Opt	Not incl.
7Y49A015JP	Xeon E-2146G 6+2C 80W 3.5GHz	1x 8GB	Onboard AHCI	3 drive bays Open bay	HH DVD-ROM	No	250W Yes	Opt	Not incl.
7Y49A00XJP	Xeon E-2174G 4+2C 71W 3.8GHz	1x 8GB	Onboard AHCI	3 drive bays Open bay	HH DVD-ROM	No	250W Yes	Opt	Not incl.
7Y49A01DJP	Xeon E-2176G 6+2C 80W 3.7GHz	1x 8GB	Onboard AHCI	3 drive bays Open bay	HH DVD-ROM	No	250W Yes	Opt	Not incl.
7Y49A01HJP	Xeon E-2186G 6+2C 95W 3.8GHz	1x 8GB	Onboard AHCI	3 drive bays Open bay	HH DVD-ROM	Option	400W Yes	Opt	Not incl.
7Y49A01MJP	Pentium G5400 2C+1 54W 3.7GHz	1x 8GB	Onboard AHCI	3 drive bays Open bay	HH DVD-ROM	No	250W Yes	Opt	Not incl.
7Y49A00LJP	Pentium G5400T 2C+1 35W 3.1GHz	1x 8GB	Onboard AHCI	3 drive bays Open bay	HH DVD-ROM	No	250W Yes	Opt	Not incl.
7Y49A01BJP	Pentium G5500 2C+2 54W 3.8GHz	1x 8GB	Onboard AHCI	3 drive bays Open bay	HH DVD-ROM	No	250W Yes	Opt	Not incl.
7Y49A00ZJP	Pentium G5600 2C+2 54W 3.9GHz	1x 8GB	Onboard AHCI	3 drive bays Open bay	HH DVD-ROM	No	250W Yes	Opt	Not incl.
7Y49A00KJP	Core i3-8100 4C+2 65W 3.6GHz	1x 8GB	Onboard AHCI	3 drive bays Open bay	HH DVD-ROM	No	250W Yes	Opt	Not incl.
7Y49A01ZJP	Core i3-8300 4C+2 62W 3.7GHz	1x 8GB	Onboard AHCI	3 drive bays Open bay	HH DVD-ROM	No	250W Yes	Opt	Not incl.
7Y49A00TJP	Core i3-8350K 4C+2 91W 4GHz	1x 8GB	Onboard AHCI	3 drive bays Open bay	HH DVD-ROM	Option	400W Yes	Opt	Not incl.
Topseller Models with a 1-year warranty (machine type 7Y49)									
7Y49A02XJP	Xeon E-2104G 4+2C 65W 3.2GHz	1x 8GB	Onboard RSTe	3 drive bays 2x 1TB HDD	HH DVD-ROM	No	250W Yes	Opt	WS19 Std Preload
7Y49A02WJP	Xeon E-2124G 4+2C 71W 3.4GHz	1x 8GB	Onboard RSTe	3 drive bays 2x 1TB HDD	HH DVD-ROM	No	250W Yes	Opt	WS19 Std Preload
7Y49A02VJP	Xeon E-2126G 6+2C 80W 3.3GHz	1x 8GB	Onboard RSTe	3 drive bays 2x 1TB HDD	HH DVD-ROM	No	250W Yes	Opt	WS19 Std Preload
7Y49A02UJP	Xeon E-2144G 4+2C 71W 3.6GHz	1x 8GB	Onboard RSTe	3 drive bays 2x 1TB HDD	HH DVD-ROM	No	250W Yes	Opt	WS19 Std Preload
7Y49A02QJP	Xeon E-2146G 6+2C 80W 3.5GHz	1x 8GB	Onboard RSTe	3 drive bays 2x 1TB HDD	HH DVD-ROM	No	250W Yes	Opt	WS19 Std Preload
7Y49A02PJP	Xeon E-2174G 4+2C 71W 3.8GHz	1x 8GB	Onboard RSTe	3 drive bays 2x 1TB HDD	HH DVD-ROM	No	250W Yes	Opt	WS19 Std Preload
7Y49A02TJP	Xeon E-2176G 6+2C 80W 3.7GHz	1x 8GB	Onboard RSTe	3 drive bays 2x 1TB HDD	HH DVD-ROM	No	250W Yes	Opt	WS19 Std Preload
7Y49A02SJP	Xeon E-2186G 6+2C 95W 3.8GHz	1x 8GB	Onboard RSTe	3 drive bays 2x 1TB HDD	HH DVD-ROM	Option	400W Yes	Opt	WS19 Std Preload
7Y49A032JP	Celeron G4900 2C+1 54W 3.1GHz	1x 8GB	Onboard RSTe	3 drive bays 2x 1TB HDD	HH DVD-ROM	No	250W Yes	Opt	WS19 Std Preload
7Y49A031JP	Pentium G5400T 2C+1 35W 3.1GHz	1x 8GB	Onboard RSTe	3 drive bays 2x 1TB HDD	HH DVD-ROM	No	250W Yes	Opt	WS19 Std Preload
7Y49A030JP	Core i3-8100 4C+2 65W 3.6GHz	1x 8GB	Onboard RSTe	3 drive bays 2x 1TB HDD	HH DVD-ROM	No	250W Yes	Opt	WS19 Std Preload
7Y49A02ZJP	Core i3-8300 4C+2 62W 3.7GHz	1x 8GB	Onboard RSTe	3 drive bays 2x 1TB HDD	HH DVD-ROM	No	250W Yes	Opt	WS19 Std Preload
7Y49A02YJP	Core i3-8350K 4C+2 91W 4GHz	1x 8GB	Onboard RSTe	3 drive bays 2x 1TB HDD	HH DVD-ROM	Option	400W Yes	Opt	WS19 Std Preload

† Processor detail: Model, compute core count + graphics core count, TDP, core frequency

Models for Latin American countries (except Brazil)

Table 7. Models for Latin American countries (except Brazil)

Model	Intel processors†	Memory	Drive Controller	Drive bays Drives	Media bay	GPU	Power supply & cord	Intru sw.	Op Sys
Topseller models with a 3-year warranty (machine type 7Y48)									
7Y48A004LA	Xeon E-2104G 4+2C 65W 3.2GHz	1x 16GB	Onboard RSTe	3 drive bays 2x 1TB HDD	HH DVD-RW	No	250W Yes	Opt	Not incl.
7Y48A005LA	Xeon E-2104G 4+2C 65W 3.2GHz	1x 16GB	Onboard RSTe	3 drive bays 1x 1TB HDD	HH DVD-RW	No	250W Yes	Opt	Not incl.
7Y48A009LA	Xeon E-2104G 4+2C 65W 3.2GHz	1x 16GB	Onboard RSTe	3 drive bays 1x 1TB HDD	HH DVD-RW	No	250W Yes	Opt	Not incl.
7Y48A00FLA	Xeon E-2104G 4+2C 65W 3.2GHz	1x 16GB	Onboard RSTe	3 drive bays 2x 2TB HDD	HH DVD-RW	No	250W Yes	Opt	Not incl.
7Y48A00GLA	Xeon E-2104G 4+2C 65W 3.2GHz	1x 16GB	Onboard RSTe	3 drive bays 2x 2TB HDD	HH DVD-RW	No	250W Yes	Opt	Not incl.
7Y48A00RLA	Xeon E-2104G 4+2C 65W 3.2GHz	1x 16GB	Onboard RSTe	3 drive bays 2x 2TB HDD	HH DVD-RW	No	250W Yes	Opt	Not incl.
7Y48A00XLA	Xeon E-2104G 4+2C 65W 3.2GHz	1x 16GB	Onboard RSTe	3 drive bays 1x 1TB HDD	HH DVD-RW	No	250W Yes	Opt	Not incl.
7Y48A00YLA	Xeon E-2104G 4+2C 65W 3.2GHz	1x 16GB	Onboard RSTe	3 drive bays 1x 2TB HDD	HH DVD-RW	No	250W Yes	Opt	Not incl.
7Y48A011LA	Xeon E-2104G 4+2C 65W 3.2GHz	1x 16GB	Onboard RSTe	3 drive bays 2x 1TB HDD	HH DVD-RW	No	250W Yes	Opt	Not incl.
7Y48A013LA	Xeon E-2104G 4+2C 65W 3.2GHz	1x 16GB	Onboard RSTe	3 drive bays 2x 1TB HDD	HH DVD-RW	No	250W Yes	Opt	Not incl.
7Y48A016LA	Xeon E-2104G 4+2C 65W 3.2GHz	1x 16GB	Onboard RSTe	3 drive bays 1x 2TB HDD	HH DVD-RW	No	250W Yes	Opt	Not incl.
7Y48A01CLA	Xeon E-2104G 4+2C 65W 3.2GHz	1x 16GB	Onboard RSTe	3 drive bays 1x 2TB HDD	HH DVD-RW	No	250W Yes	Opt	Not incl.
7Y48A000LA	Xeon E-2104G 4+2C 65W 3.2GHz	1x 8GB	Onboard RSTe	3 drive bays 2x 2TB HDD	HH DVD-RW	No	250W Yes	Opt	Not incl.
7Y48A002LA	Xeon E-2104G 4+2C 65W 3.2GHz	1x 8GB	Onboard RSTe	3 drive bays 2x 2TB HDD	HH DVD-RW	No	250W Yes	Opt	Not incl.
7Y48A00ELA	Xeon E-2104G 4+2C 65W 3.2GHz	1x 8GB	Onboard RSTe	3 drive bays 2x 2TB HDD	HH DVD-RW	No	250W Yes	Opt	Not incl.
7Y48A00JLA	Xeon E-2104G 4+2C 65W 3.2GHz	1x 8GB	Onboard RSTe	3 drive bays 1x 2TB HDD	HH DVD-RW	No	250W Yes	Opt	Not incl.
7Y48A00KLA	Xeon E-2104G 4+2C 65W 3.2GHz	1x 8GB	Onboard RSTe	3 drive bays 1x 1TB HDD	HH DVD-RW	No	250W Yes	Opt	Not incl.
7Y48A00MLA	Xeon E-2104G 4+2C 65W 3.2GHz	1x 8GB	Onboard RSTe	3 drive bays 1x 2TB HDD	HH DVD-RW	No	250W Yes	Opt	Not incl.
7Y48A00NLA	Xeon E-2104G 4+2C 65W 3.2GHz	1x 8GB	Onboard RSTe	3 drive bays 1x 2TB HDD	HH DVD-RW	No	250W Yes	Opt	Not incl.
7Y48A00SLA	Xeon E-2104G 4+2C 65W 3.2GHz	1x 8GB	Onboard RSTe	3 drive bays 1x 1TB HDD	HH DVD-RW	No	250W Yes	Opt	Not incl.
7Y48A00ULA	Xeon E-2104G 4+2C 65W 3.2GHz	1x 8GB	Onboard RSTe	3 drive bays 1x 1TB HDD	HH DVD-RW	No	250W Yes	Opt	Not incl.
7Y48A00VLA	Xeon E-2104G 4+2C 65W 3.2GHz	1x 8GB	Onboard RSTe	3 drive bays 2x 1TB HDD	HH DVD-RW	No	250W Yes	Opt	Not incl.
7Y48A012LA	Xeon E-2104G 4+2C 65W 3.2GHz	1x 8GB	Onboard RSTe	3 drive bays 2x 1TB HDD	HH DVD-RW	No	250W Yes	Opt	Not incl.

Model	Intel processors†	Memory	Drive Controller	Drive bays Drives	Media bay	GPU	Power supply & cord	Intru sw.	Op Sys
7Y48A01BLA	Xeon E-2104G 4+2C 65W 3.2GHz	1x 8GB	Onboard RSTe	3 drive bays 2x 1TB HDD	HH DVD- RW	No	250W Yes	Opt	Not incl.
Standard Models with a 1-year warranty (machine type 7Y49)									
7Y491000LA	Xeon E-2104G 4+2C 65W 3.2GHz	1x 8GB	Onboard RSTe	3 drive bays 1x S4510 480GB	HH DVD- RW	No	250W Yes	Yes	Not incl.
7Y491001LA	Xeon E-2104G 4+2C 65W 3.2GHz	1x 8GB	Onboard RSTe	3 drive bays 1x S4510 480GB	HH DVD- RW	No	250W Yes	Yes	Not incl.
7Y491002LA	Xeon E-2104G 4+2C 65W 3.2GHz	1x 8GB	Onboard RSTe	3 drive bays 1x S4510 480GB	HH DVD- RW	No	250W Yes	Yes	Not incl.
7Y491004LA	Xeon E-2104G 4+2C 65W 3.2GHz	1x 8GB	Onboard RSTe	3 drive bays 1x S4510 960GB	HH DVD- RW	No	250W Yes	Yes	Not incl.
7Y491005LA	Xeon E-2104G 4+2C 65W 3.2GHz	1x 8GB	Onboard RSTe	3 drive bays 1x S4510 960GB	HH DVD- RW	No	250W Yes	Yes	Not incl.
7Y491006LA	Xeon E-2104G 4+2C 65W 3.2GHz	1x 8GB	Onboard RSTe	3 drive bays 1x S4510 960GB	HH DVD- RW	No	250W Yes	Yes	Not incl.
7Y491008LA	Xeon E-2124 4C 71W 3.3GHz	1x 16GB	Onboard RSTe	3 drive bays 1x S4510 960GB	HH DVD- RW	P620	400W Yes	Yes	Not incl.
7Y491009LA	Xeon E-2124 4C 71W 3.3GHz	1x 16GB	Onboard RSTe	3 drive bays 1x S4510 960GB	HH DVD- RW	P620	400W Yes	Yes	Not incl.
7Y49100ALA	Xeon E-2124 4C 71W 3.3GHz	1x 16GB	Onboard RSTe	3 drive bays 1x S4510 960GB	HH DVD- RW	P620	400W Yes	Yes	Not incl.

Models for USA and Canada

Table 8. Models for USA and Canada

Model	Intel processor†	Memory	Drive Controller	Drive bays Drives	Media bay	GPU	Power supply & cord	Intru sw.	Op Sys
Standard models with a 3-year warranty (machine type 7Y48)									
7Y481000NA	Xeon E-2124G 4+2C 71W 3.4GHz	1x 8GB	Onboard RSTe	3 drive bays 2x 1TB HDD	HH DVD-RW	No	250W Yes	Opt	WS19 Ess Preload
7Y48A026NA	Xeon E-2124G 4+2C 71W 3.4GHz	1x 8GB	Onboard AHCI	3 drive bays Open bay	HH DVD-RW	No	250W Yes	Opt	Not incl.
7Y48A028NA	Xeon E-2144G 4+2C 71W 3.6GHz	1x 8GB	Onboard AHCI	4 drive bays Open bay	Slim DVD-RW + 3.5-in bay	No	250W Yes	Opt	Not incl.
7Y48A027NA	Xeon E-2176G 6+2C 80W 3.7GHz	1x 8GB	Onboard AHCI	4 drive bays Open bay	Slim DVD-RW + 3.5-in bay	No	250W Yes	Opt	Not incl.
Standard models with a 1-year warranty (machine type 7Y49)									
7Y49A01XNA	Xeon E-2104G 4+2C 65W 3.2GHz	1x 8GB	Onboard AHCI	3 drive bays Open bay	Open	No	250W Yes	Opt	Not incl.
7Y49A018NA	Xeon E-2124 4C 71W 3.3GHz	1x 8GB	Onboard AHCI	3 drive bays Open bay	HH DVD-RW	P620	400W Yes	Opt	Not incl.
7Y49A01FNA	Xeon E-2126G 6+2C 80W 3.3GHz	1x 8GB	Onboard AHCI	3 drive bays Open bay	Open	No	250W Yes	Opt	Not incl.
7Y49A00RNA	Xeon E-2134 4C 71W 3.5GHz	1x 8GB	Onboard AHCI	3 drive bays Open bay	Open	P620	400W Yes	Opt	Not incl.
7Y49A01ANA	Xeon E-2136 6C 80W 3.3GHz	1x 8GB	Onboard AHCI	3 drive bays Open bay	Open	P620	400W Yes	Opt	Not incl.
7Y49A01ENA	Xeon E-2146G 6+2C 80W 3.5GHz	1x 8GB	Onboard AHCI	3 drive bays Open bay	Open	No	250W Yes	Opt	Not incl.
7Y49A00QNA	Xeon E-2174G 4+2C 71W 3.8GHz	1x 8GB	Onboard AHCI	3 drive bays Open bay	Open	No	250W Yes	Opt	Not incl.
7Y49A01QNA	Xeon E-2186G 6+2C 95W 3.8GHz	1x 8GB	Onboard AHCI	3 drive bays Open bay	Open	No	250W Yes	Opt	Not incl.
TopSeller models with a 1-year warranty (machine type 7Y49)									
7Y49A013NA	Xeon E-2124G 4+2C 71W 3.4GHz	1x 8GB	Onboard AHCI	3 drive bays Open bay	HH DVD-RW	No	250W Yes	Opt	Not incl.
7Y49A01CNA	Xeon E-2144G 4+2C 71W 3.6GHz	1x 8GB	Onboard AHCI	4 drive bays Open bay	Slim DVD-RW + 3.5-in bay	No	250W Yes	Opt	Not incl.
7Y49A00YNA	Xeon E-2176G 6+2C 80W 3.7GHz	1x 8GB	Onboard AHCI	4 drive bays Open bay	Slim DVD-RW + 3.5-in bay	No	250W Yes	Opt	Not incl.

† Processor detail: Model, compute core count + graphics core count, TDP, core frequency

Processors

The ST50 supports one processor from the Intel product family formerly known by the codename "Coffee Lake". This includes processors from the Intel Xeon E, Core i3, Pentium and Celeron families.

The server supports the processor options that are listed in the following table.

All supported processors have the following characteristics:

- 14 nm semiconductor process technology
- 8 GT/s DMI3 bus speed
- Two DDR4 memory channels
- 16 PCIe 3.0 I/O lanes

Integrated graphics: As indicated in the table, some processors do not include Integrated graphics. if you use one of these processors in your configuration, you will also need to select a [GPU adapter](#) and a 400W power supply.

Table 9. Processor options

Feature code	Intel CPU	TDP	Cores	Integ. graphics / cores	Base core speed	Cache	Memory bus speed	ECC	HT	Turbo Boost / Max speed	VT	AMT	Intel SGX
Intel Celeron processors													
B35E	G4900	54W	2 / 2	Yes / 1	3.1 GHz	2 MB	2400 MHz	Yes	No	No	Yes	No	No
B35H	G4900T	35W	2 / 2	Yes / 1	2.9 GHz	2 MB	2400 MHz	Yes	No	No	Yes	No	No
B35D	G4920	54W	2 / 2	Yes / 1	3.2 GHz	2 MB	2400 MHz	Yes	No	No	Yes	No	No
Intel Core i3 processors													
B357	i3-8100	65W	4 / 4	Yes / 2	3.6 GHz	6 MB	2400 MHz	Yes	No	No	Yes	No	No
B359	i3-8100T	35W	4 / 4	Yes / 2	3.1 GHz	6 MB	2400 MHz	Yes	No	No	Yes	No	No
B356	i3-8300	62W	4 / 4	Yes / 2	3.7 GHz	8 MB	2400 MHz	Yes	No	No	Yes	No	No
B358	i3-8300T	35W	4 / 4	Yes / 2	3.2 GHz	8 MB	2400 MHz	Yes	No	No	Yes	No	No
B355	i3-8350K	91W	4 / 4	Yes / 2	4.0 GHz	8 MB	2400 MHz	Yes	No	No	Yes	No	No
Intel Pentium processors													
B35C	G5400	58W	2 / 4	Yes / 1	3.7 GHz	4 MB	2400 MHz	Yes	Yes	No	Yes	No	No
B35G	G5400T	35W	2 / 4	Yes / 1	3.1 GHz	4 MB	2400 MHz	Yes	Yes	No	Yes	No	No
B35B	G5500	54W	2 / 4	Yes / 2	3.8 GHz	4 MB	2400 MHz	Yes	Yes	No	Yes	No	No
B35F	G5500T	35W	2 / 4	Yes / 2	3.2 GHz	4 MB	2400 MHz	Yes	Yes	No	Yes	No	No
B35A	G5600	54W	2 / 4	Yes / 2	3.9 GHz	4 MB	2400 MHz	Yes	Yes	No	Yes	No	No
Intel Xeon E-2100 processors													
B354	E-2104G	65W	4 / 4	Yes / 2	3.2 GHz	8 MB	2666 MHz	Yes	No	No	Yes	Yes	No
B353	E-2124	71W	4 / 4	None	3.3 GHz	8 MB	2666 MHz	Yes	No	Yes / 4.30 GHz	Yes	Yes*	No
B352	E-2124G	71W	4 / 4	Yes / 2	3.4 GHz	8 MB	2666 MHz	Yes	No	Yes / 4.50 GHz	Yes	Yes	No
B351	E-2126G	80W	6 / 6	Yes / 2	3.3 GHz	12 MB	2666 MHz	Yes	No	Yes / 4.50 GHz	Yes	Yes	No
B350	E-2134	71W	4 / 8	None	3.5 GHz	8 MB	2666 MHz	Yes	Yes	Yes / 4.50 GHz	Yes	Yes*	No
B34Z	E-2136	80W	6 / 12	None	3.3 GHz	12 MB	2666 MHz	Yes	Yes	Yes / 4.50 GHz	Yes	Yes*	No
B34Y	E-2144G	71W	4 / 8	Yes / 2	3.6 GHz	8 MB	2666 MHz	Yes	Yes	Yes / 4.50 GHz	Yes	Yes	No
B34X	E-2146G	80W	6 / 12	Yes / 2	3.5 GHz	12 MB	2666 MHz	Yes	Yes	Yes / 4.50 GHz	Yes	Yes	No
B34W	E-2174G	71W	4 / 8	Yes / 2	3.8 GHz	8 MB	2666 MHz	Yes	Yes	Yes / 4.70 GHz	Yes	Yes	Yes†
B34V	E-2176G	80W	6 / 12	Yes / 2	3.7 GHz	12 MB	2666 MHz	Yes	Yes	Yes / 4.70 GHz	Yes	Yes	Yes†
B34U	E-2186G	95W	6 / 12	Yes / 2	3.8 GHz	12 MB	2666 MHz	Yes	Yes	Yes / 4.70 GHz	Yes	Yes	Yes†

* Xeon E processors without integrated graphics do not support the KVM redirection functions of AMT.
 † Intel SGX support requires UEFI V1.03 (ISE110C) or later.

Memory options

The ST50 server supports Lenovo TruDDR4 memory. TruDDR4 memory uses the highest-quality components sourced from Tier 1 DRAM suppliers and only memory that meets strict requirements is selected. It is compatibility-tested and tuned to maximize performance and reliability.

TruDDR4 memory has a unique signature programmed into the DIMM, which enables ThinkSystem servers to verify whether the memory installed is qualified and supported. From a service and support standpoint, TruDDR4 memory automatically assumes the system's warranty, and service and support provided worldwide.

The ST50 supports up to 4 DIMMs. The processors have 2 memory channels and support 2 DIMMs per channel.

All DIMMs operate at a speed of 2666 MHz. However, if the processor selected has a lower memory bus speed (eg 2400 MHz - see the [Processor](#) table), then all DIMMs will operate at that lower speed.

The following table lists the memory options that are available for the ST550 server.

Table 10. Memory options

Part number	Feature code	Description	Maximum supported
ECC UDIMMs - available world wide			
4ZC7A08696	B35J	ThinkSystem 8GB TruDDR4 2666MHz (1Rx8, 1.2V) UDIMM	4
4ZC7A08699	B35K	ThinkSystem 16GB TruDDR4 2666MHz (2Rx8, 1.2V) UDIMM	4
Non-ECC UDIMMs - available only in China			
4ZC7A08700	B35L	ThinkSystem 4GB TruDDR4 2666MHz (1Rx16, 1.2V) Non-ECC UDIMM	4
4ZC7A08701	B35M	ThinkSystem 8GB TruDDR4 2666MHz (1Rx8, 1.2V) Non-ECC UDIMM	4
4ZC7A08702	B35N	ThinkSystem 16GB TruDDR4 2666MHz (2Rx8, 1.2V) Non-ECC UDIMM	4

The following rules and recommendations apply when selecting the memory configuration:

- The server only supports UDIMMs
- Mixing of ECC and non-ECC DIMMs is not supported.
- All DIMMs must be identical. Mixing DIMMs is not supported.
- For best performance when installing two DIMMs, install one in each memory channel

Internal storage

The ST50 supports up to four 3.5-inch non-hot-swap drives plus two SD Cards for internal storage.

The non-hot-swap drive bays are as follows:

- Three drive bays dedicated to 3.5-inch HDDs or SSDs
- One 5.25-inch media drive bay which can hold a fourth 3.5-inch HDDs or SSDs

The location of these bays is shown in the following figure. The ST50 drive option part numbers include the SATA cable and power cable needed to connect the drive to the onboard SATA controller on the system board.

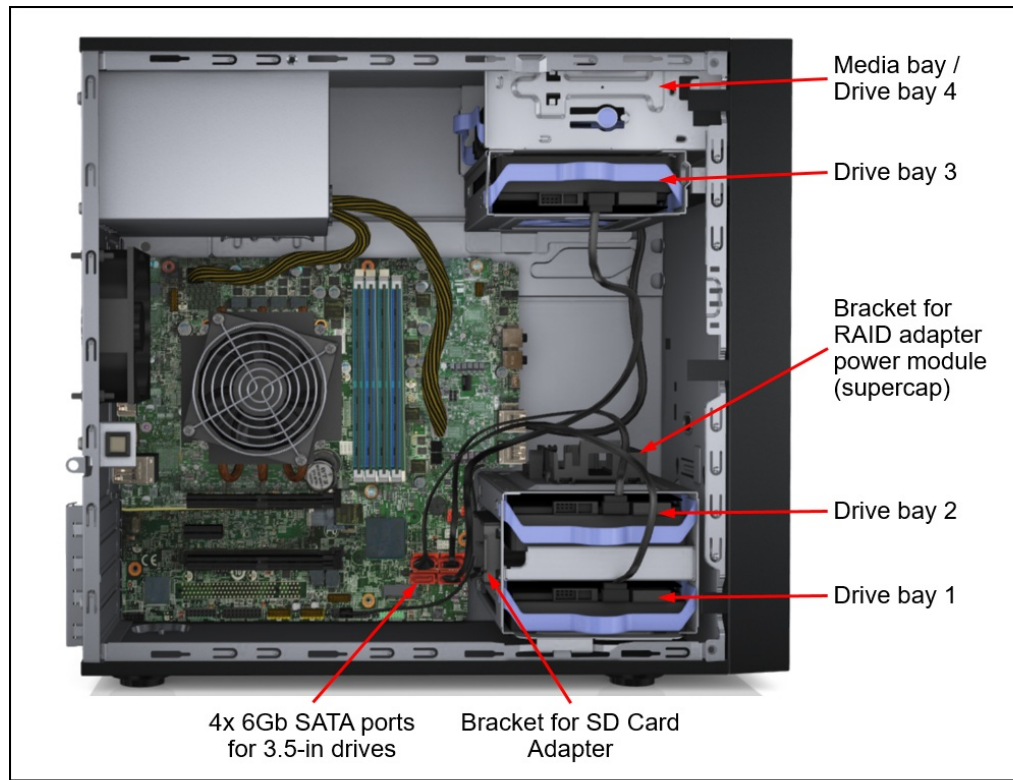

Figure 6. ST50 drive bays

The 5.25-inch media bay (bay 4) supports any one of the following configurations:

- 3.5-inch non-hot-swap HDD or SSD in a 5.25-inch conversion tray
- Combination 3.5-inch non-hot-swap HDD or SSD plus a slim optical DVD-RW
- Half-high optical drive (either DVD-ROM or DVD-RW)
- Half-high backup unit (either LTO tape or RDX drive)
- Empty bay

The ordering information for the drive trays is listed in the following table.

Table 11. Conversion tray and SD Adapter kit

Part number	Feature code	Description
4M17A12096	B35U	ThinkSystem ST50 5.25" to 3.5" HDD Kit w/ Slim ODD (provides a bay for a 3.5-inch HDD or SSD + a bay for a slim optical drive)
CTO only*	B35V	ThinkSystem 5.25" to 3.5" HDD Conversion Kit W/O Slim ODD (provides a bay for a 3.5-inch HDD or SSD without an optical drive bay)
4M17A12095	B3YV	ThinkSystem ST50 Dual SD Cards Adapter Kit, which contains: <ul style="list-style-type: none"> • Adapter that supports two SD Cards • Bracket to mount the adapter to the side of bays 1 and 2 • Cable to connect the adapter to the system board

* Configure-to-order only; Not available as a field upgrade

The server also supports 1 or 2 SD Cards that are installed in an adapter, 4M17A12095 as listed in the table. The adapter is mounted on the side of drive bays 1 and 2 as shown in the figure above. The SD Cards can be used as boot devices or are accessible to the operating system as drives (JBOD). The adapter does not offer any RAID functionality.

Controllers for internal storage

The ST50 has an onboard 6Gbps SATA controller with 4 connections on the system board for the 4 internal drive bays. These ports can be used in either AHCI (JBOD) mode or RSTe (RAID) mode. RSTe mode supports RAID 0, 1, 5 and 10.

Virtualization support: The SATA ports can be used with virtualization hypervisors, including VMware ESXi, Linux KVM, Xen, and Microsoft Hyper-V, however support is limited to AHCI (non-RAID) mode. RSTe mode is not supported with virtualization hypervisors.

Advanced RAID support or HBA support is available with the addition of a RAID adapter or HBA as listed in the following table. The HBA is needed when an internal LTO tape drive is installed.

Table 12. Adapters for internal storage

Part number	Feature code	Description	Slots supported	Maximum supported
SAS/SATA HBA				
7Y37A01088	AUNL	ThinkSystem 430-8i SAS/SATA 12Gb HBA	1,3	1
RAID adapters				
7Y37A01082	AUNG	ThinkSystem RAID 530-8i PCIe 12Gb Adapter	1,3	1
7Y37A01083*	AUNH*	ThinkSystem RAID 730-8i 1GB Cache PCIe 12Gb Adapter	1,3	1
4Y37A09722	B4RQ	ThinkSystem RAID 730-8i 2GB Flash PCIe 12Gb Adapter	1,3	1
7Y37A01084	AUNJ	ThinkSystem RAID 930-8i 2GB Flash PCIe 12Gb Adapter	1,3	1
Cable and Power Module Bracket Kit for internal RAID adapter				
4M17A12094	B46W	ThinkSystem ST50 RAID/HBA Cable & Flash Module Mechanical Kit, contains: <ul style="list-style-type: none"> • Mini-SAS HD-to-4x SATA cable • Bracket for flash power module for RAID 930-8i (supercap holder) 	None	1

* The RAID 730-8i 1GB Cache adapter is not available in USA and Canada

If you are planning to do a field upgrade to add a RAID adapter or HBA for connectivity to the drives, you will need to order the RAID/HBA Cable & Flash Module Mechanical Kit, 4M17A12094. This kit contains the cable which connects the adapter to the four SATA drives, replacing the existing four SATA cables. For the RAID 930-8i adapter, the kit also contains the bracket for the RAID adapter's flash power module. The bracket is mounted on top of drive bay 2 as shown in [Figure 6](#). For CTO and preconfigured models in the configurator tool, the cable and flash power module bracket are automatically added if needed.

The following table compare the functions of the storage adapters and the onboard SATA controller.

Table 13. Comparison of internal storage controllers - RAID controllers

Feature	Intel RSTe	430-8i	RAID 530-8i	RAID 730-8i 1GB*	RAID 730-8i 2GB	RAID 930-8i
Adapter type	Software RAID	HBA	RAID controller	RAID controller	RAID controller	RAID controller
Part number	None	7Y37A01088	7Y37A01082	7Y37A01083	4Y37A09722	7Y37A01084
Form factor	Onboard	PCIe low profile	PCIe low profile	PCIe low profile	PCIe low profile	PCIe low profile
Controller chip	Intel PCH (RSTe)	LSI SAS3408	LSI SAS3408	LSI SAS3108	LSI SAS3108	LSI SAS3508
Host interface	Not applicable	PCIe 3.0 x8	PCIe 3.0 x8	PCIe 3.0 x8	PCIe 3.0 x8	PCIe 3.0 x8
Port interface	6 Gb SATA	12 Gb SAS	12 Gb SAS	12 Gb SAS	12 Gb SAS	12 Gb SAS
Number of ports	4	8	8	8	8	8
Port connectors	4x onboard SATA	2x Mini-SAS HD x4 (SFF-8643)	2x Mini-SAS HD x4 (SFF-8643)	2x Mini-SAS HD x4 (SFF-8643)	2x Mini-SAS HD x4 (SFF-8643)	2x Mini-SAS HD x4 (SFF-8643)
Drive interface	SATA	SAS, SATA	SAS, SATA	SAS, SATA	SAS, SATA	SAS, SATA
Drive type	HDD, SSD	HDD, SSD, SED**	HDD, SSD, SED**	HDD, SSD	HDD, SSD, SED**	HDD, SSD, SED**
Max devices (ST50)	4	4	4	4	4	4
RAID levels (with 4 drives)	0, 1, 10, 5	No RAID	0, 1, 10, 5	0, 1, 10, 5	0, 1, 10, 5, 50, 6	0, 1, 10, 5, 6
JBOD mode	Yes (AHCI)	Yes	Yes	Yes	Yes	Yes
Cache	None	No	None	1GB (Standard)	2GB (Standard)	2GB (Standard)
CacheVault cache protection	No	No	No	No	Yes (Flash)	Yes (Flash)
Performance Accelerator (FastPath)	No	No	Yes	No	Yes	Yes
SSD Caching (CacheCade Pro 2.0)	No	No	No	No	No	No
SED support	No	Yes**	Yes (SafeStore)**	No	Yes (SafeStore)**	Yes (SafeStore)**

* RAID 730-8i is not available in USA and Canada

** SED support if/once the ST50 supports SED drives. SAS HBAs support SEDs (self-encrypting drives) by using software on the server and simply passing SED commands through the HBA to the drives.

Internal drive options

The following tables list the hard disk drive and solid-state drive options for the internal disk storage of the server.

Each drive option part number includes a SATA signal cable and a power cable to connect the drive to the onboard SATA controller on the system board.

Table 14. Supported HDDs and SSDs

Part number	Feature	Description	Maximum supported
Hard disk drives			
4XB7A13554	B36T	ThinkSystem ST50 3.5" 1TB 7.2K SATA 6Gb Non-Hot Swap 512n HDD	4
4XB7A13555	B36U	ThinkSystem ST50 3.5" 2TB 7.2K SATA 6Gb Non-Hot Swap 512n HDD	4
4XB7A13556	B36V	ThinkSystem ST50 3.5" 4TB 7.2K SATA 6Gb Non-Hot Swap 512n HDD	4
4XB7A13557	B36W	ThinkSystem ST50 3.5" 6TB 7.2K SATA 6Gb Non-Hot Swap 512e HDD	4
4XB7A13558	B36X	ThinkSystem ST50 3.5" 8TB 7.2K SATA 6Gb Non-Hot Swap 512e HDD	4
Solid-state drives			
4XB7A14914	B4N4	ThinkSystem ST50 3.5" Intel S4510 240GB Entry SATA 6Gb Non Hot Swap SSD	4
4XB7A14915	B4N5	ThinkSystem ST50 3.5" Intel S4510 480GB Entry SATA 6Gb Non Hot Swap SSD	4
4XB7A14916	B4N6	ThinkSystem ST50 3.5" Intel S4510 960GB Entry SATA 6Gb Non Hot Swap SSD	4
4XB7A14051	B63S	ThinkSystem ST50 3.5" 5200 960GB Entry SATA 6Gb Non Hot Swap SSD	4
4XB7A14050	B63R	ThinkSystem ST50 3.5" 5200 480GB Entry SATA 6Gb Non Hot Swap SSD	4

The following table lists the supported SD Cards.

Table 15. SD Cards

Part number	Feature code	Description	Maximum supported
4X77A12158	B3VZ	Blank SanDisk AF3 32G SD Card	2
4X77A12159	B3W0	Blank SanDisk AF3 64G SD Card	2

Internal backup units

The server supports the internal backup unit options that are listed in the following table.

Table 16. Internal backup units

Part number	Feature code	Description
Cable Kit for internal RDX and LTO drives		
4Z57A13568	B46V	ThinkSystem ST50 HH ODD / Tape Cable Kit, contains: <ul style="list-style-type: none"> • Power cable needed for HH optical drives, RDX drive and LTO tape drive • SATA cable only needed for HH optical drives
LTO Drive and Media		
4T27A10727	B4BM	ThinkSystem Internal Half High LTO Gen8 SAS Tape Drive
4TP7A09619	B4BN	ThinkSystem LTO Gen8 12TB Tape
7T27A01503	AVF5	ThinkSystem Internal Half High LTO7 SAS Tape Drive
7TP7A01606	AVF7	ThinkSystem LTO7 6TB Tape
RDX Drive and Media		
7T27A01501	AVF6	ThinkSystem Internal RDX USB 3.0 Dock
7TP7A04318	AXD1	ThinkSystem RDX 4TB Cartridge
7TP7A01603	AVF0	ThinkSystem RDX 2TB Cartridge
7TP7A01602	AVF1	ThinkSystem RDX 1TB Cartridge
7TP7A01601	AVF8	ThinkSystem RDX 500GB Cartridge

* The LTO tape drive is not available configure-to-order

The RDX drive is attached via the USB 3.0 port on the system board. The RDX drive requires a USB cable (included in the drive part number) and a power cable (included in cable kit 4Z57A13568).

The use of an LTO tape drive requires the ThinkSystem 430-8i SAS/SATA 12Gb HBA, 7Y37A01088. The LTO tape requires a SAS cable (included in the drive part number) and a power cable (included in cable kit 4Z57A13568).

For more information about RDX drive and LTO tape drives, see the Backup Units page on the Lenovo Press site: <https://lenovopress.com/servers/options/backup>

Optical drives

The ST50 supports the optical drive options listed in the following table. The internal optical drive is installed in the 5.25-inch media bay.

Table 17. Optical drives

Part number	Feature code	Description
Cable Kit for internal HH optical drives		
4Z57A13568	B46V	ThinkSystem ST50 HH ODD / Tape Cable Kit, contains: <ul style="list-style-type: none"> • Power cable needed for HH optical drives, RDX drive and LTO tape drive • SATA cable only needed for HH optical drives
Conversion Kit for Slim optical drive		
4M17A12096	B35U	ThinkSystem ST50 5.25" to 3.5" HDD Kit w/ Slim ODD
Internal optical drives		
4XA7A08377	B36S	9.5mm Ultra-Slim USB DVD-RW
7XA7A01204	AVEZ	ThinkSystem Half High SATA DVD-ROM Optical Disk Drive
7XA7A01202	AVEY	ThinkSystem Half High SATA DVD-RW Optical Disk Drive
External optical drive		
7XA7A05926	AVV8	ThinkSystem External USB DVD RW Optical Disk Drive

The half-high optical drives are attached via a SATA port on the system board. The power and SATA cable are included in cable kit 4Z57A13568.

The use of the slim optical drive requires the media bay conversion kit 4M17A12096 (which also adds a fourth drive bay). The drive is connected by a USB cable which is included in the drive option part number. A separate power cable is not needed.

I/O expansion options

The ST50 server has three PCIe 3.0 slots:

- Slot 1: PCIe 3.0 x16 full-height half-length (FHHL)
- Slot 2: PCIe 3.0 x1 full-height half-length (FHHL)
- Slot 3: PCIe 3.0 x4 (physical connector is x16) full-height half-length (FHHL)

The following figure shows the locations of the PCIe slots.

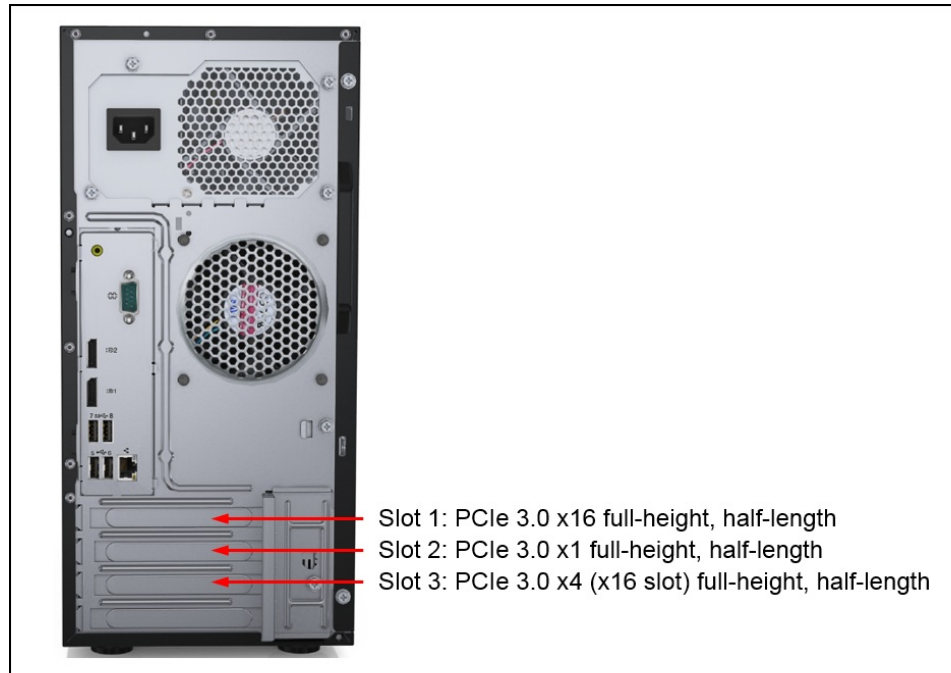

Figure 7. ThinkSystem ST50 PCIe slots

Network adapters

The server has one integrated Gigabit Ethernet port that is based on the Intel I219-LM NIC (a shared port for operating system access and management network).

The onboard NIC has the following features:

- 1 Gb Ethernet IEEE 802.3, 802.3u, and 802.3ab PHY specifications compliant
- Integrated PHY for 10/100/1000 Mbps with speed and duplex auto-negotiation
- Energy Efficient Ethernet (IEEE 802.3az)
- Wake on LAN
- VLAN tagging (IEEE 802.1Q)
- Class of Service (CoS) priority (IEEE 802.1p) marking
- TCP/UDP checksum and segmentation offload (IPv4 and IPv6)
- Receive Side Scaling
- Jumbo Frames (up to 9K)
- Timing and Synchronization (IEEE 802.1as / IEEE 1588)
- Load balancing and failover teaming support:
 - Adapter fault tolerance (AFT)
 - Switch fault tolerance (SFT)
 - Adaptive load balancing (ALB)

The following table lists other supported network adapters. The maximum supported column indicates which slots each adapter is supported in. For slot locations see the [I/O expansion options](#) section.

Table 18. Network adapters

Part number	Feature code	Description	Slots supported	Maximum supported
Gigabit Ethernet				
7ZT7A00534	AUZY	ThinkSystem I350-T2 PCIe 1Gb 2-Port RJ45 Ethernet Adapter	1,3	2
7ZT7A00535	AUZW	ThinkSystem I350-T4 PCIe 1Gb 4-Port RJ45 Ethernet Adapter	1,3	2
7ZT7A00484	AUZV	ThinkSystem Broadcom 5719 1GbE RJ45 4-Port PCIe Ethernet Adapter	3	1
7ZT7A00482	AUZX	ThinkSystem Broadcom 5720 1GbE RJ45 2-Port PCIe Ethernet Adapter	2,3	2
10 Gb Ethernet				
00MM850	ATRY	Intel X550-T1 Single Port 10GBase-T Adapter	1,3	2
00MM860	ATPX	Intel X550-T2 Dual Port 10GBase-T Adapter	1,3	2
7XC7A05525	B0YL	Intel X710-DA4 4x10Gb SFP+ Adapter	1,3	2*
7ZT7A00496	AUKP	ThinkSystem Broadcom 57416 10GBASE-T 2-Port PCIe Ethernet Adapter	1,3	2

* Requires SFP+ transceivers or DAC cables that must be purchased separately.

For more information, including the transceivers and cables that each adapter supports, see the list of Lenovo Press Product Guides in the Ethernet adapters category:

<https://lenovopress.com/servers/options/ethernet>

SAS adapters for external storage

The following table lists the SAS HBAs and RAID adapters suitable for connectivity to external storage.

Table 19. Supported SAS HBAs and RAID adapters

Part number	Feature code	Description	Slots supported	Maximum supported
12 Gb SAS HBA				
7Y37A01090	AUNR	ThinkSystem 430-8e SAS/SATA 12Gb HBA	1,3	1
12 Gb RAID Adapter				
7Y37A01087	AUNQ	ThinkSystem RAID 930-8e 4GB Flash PCIe 12Gb Adapter	1,3	1
Cable and Power Module Bracket Kit for external RAID adapter				
4M17A12094	B46W	ThinkSystem ST50 RAID/HBA Cable & Flash Module Mechanical Kit, contains: <ul style="list-style-type: none"> Mini-SAS HD-to-4x SATA cable (not used with RAID 930-8e) Bracket for flash power module for RAID 930-8e (supercap holder) 	None	1

If you are planning to do a field upgrade to add the RAID 930-8e adapter, you will need to order the RAID/HBA Cable & Flash Module Mechanical Kit, 4M17A12094. This kit contains the bracket for the RAID adapter's flash power module. The bracket is mounted on top of drive bay 2 as shown in [Figure 6](#). For CTO models in the configurator tool, the flash power module bracket is automatically added if needed.

The following table summarizes the features of supported adapters.

Table 20. Comparison of features

Feature	430-8e	RAID 930-8e
Adapter type	HBA	External RAID
Part number	7Y37A01090	7Y37A01087
Controller chip	LSI SAS3408	LSI SAS3516
Broadcom equivalent	HBA 9400-8e	MegaRAID 9480-8e
Host interface	PCIe 3.0x8	PCIe 3.0x8
Port interface	12 Gb SAS	12 Gb SAS
Number of ports	8	8
Port connectors	2x Mini-SAS HD SFF8644	2x Mini-SAS HD SFF8644
Drive interface	SAS/SATA	SAS,SATA
Drive type	HDD/SSD/SED*	HDD,SED,SSD
Hot-swap drives	Yes	Yes
Maximum devices	1024	216
RAID levels	None	0/1/10/5/50/6/60
JBOD mode	Yes	Yes
Cache	None	4GB (Standard)
CacheVault cache protection	None	Yes (Flash)
Performance Accelerator (FastPath)	No	Yes
SSD Caching (CacheCade Pro 2.0)	No	No
SED support*	Yes*	Yes

* SED (self-encrypting drive) support of the SAS HBA is by using software on the server (SED commands are passed through the HBA to the drives).

Parallel Port adapter

The ST50 supports the addition of a parallel port adapter. This adapter is based on the Sunix PAR6408A adapter and adheres to the IEEE 1284 standard for bi-directional parallel communications. The adapter has a full-height (3U) bracket attached.

Table 21. Parallel port

Part number	Feature code	Description	Slots supported	Maximum supported
4C57A39561	B7MG	ThinkSystem Parallel Port PCIe Adapter	2, 3	2

Fibre Channel host bus adapters

The ST50 does not support Fibre Channel HBAs.

Flash Storage adapters

The ST50 does not support Flash Storage adapters.

GPU adapters

The ST50 server supports the graphics processing units (GPUs) listed in the following table.

Notes:

- If the processor selected does not include integrated graphics, then a GPU must be selected.
- The use of a GPU requires a chassis base with a 400W power supply
- If a GPU is installed in a server that has a processor with integrated graphics, the integrated graphics (and the two DisplayPort video ports) will be disabled.

Table 22. GPU adapters

Part number	Feature code	Description	Slots supported	Maximum supported
4X67A11584	B31D	ThinkSystem NVIDIA Quadro P620 2GB PCIe Active GPU	1	1

For details about the P620 GPU, see the ThinkSystem GPU Summary:

<https://lenovopress.com/lp0768-thinksystem-gpu-summary>

Fans and cooling

The server can operate in environments up to ASHRAE A2 (35°C and 90% humidity).

The server has the following fans:

- One 80mm system fan at the front of the server inside the front bezel
- One 90mm system fan at the rear of the server
- Fan mounted on the heatsink of the processor
- Power supply fan
- Fan in the optional media bay enclosure

See the Inside view in the [Components and connectors](#) section for locations.

Power supplies

The server has either a fixed 250W or 400W power supply, depending on the chassis base selected. The power supply cannot be upgraded.

Table 23. Power supply options

Feature code	Chassis base	Power supply	Voltage	80 PLUS certification	Configuration restrictions
B36B	ThinkSystem ST50 ATX-250W Chassis Base	250W	100-240V (autosensing)	Platinum	No support for a GPU adapter
B36C	ThinkSystem ST50 ATX-400W Chassis Base	400W	100-240V (autosensing)	Platinum	No restrictions

The inclusion of a power cord is model dependent as listed in the [Models](#) section.

Power cords

Line cords can be ordered as listed in the following table.

Table 24. Power cords

Region	Part number	Feature	Description
Argentina	39Y7930	6222	2.8m, 10A/250V, C13 to IRAM 2073 (Argentina) Line Cord
Argentina	81Y2384	6492	4.3m, 10A/220V, C13 to IRAM 2073 (Argentina) Line Cord
Australia/NZ	39Y7924	6211	2.8m, 10A/250V, C13 to AS/NZ 3112 (Australia/NZ) Line Cord
Australia/NZ	81Y2383	6574	4.3m, 10A/230V, C13 to AS/NZS 3112 (Aus/NZ) Line Cord
Brazil	69Y1988	6532	2.8m, 10A/250V, C13 to NBR 14136 (Brazil) Line Cord
Brazil	81Y2387	6404	4.3m, 10A/250V, C13 - 2P+Gnd (Brazil) Line Cord
China	39Y7928	6210	2.8m, 220-240V, C13 to GB 2099.1 (China) Line Cord
China	81Y2378	6580	4.3m, 10A/220V, C13 to GB 2099.1 (China) Line Cord
Denmark	39Y7918	6213	2.8m, 10A/250V, C13 to DK2-5a (Denmark) Line Cord
Denmark	81Y2382	6575	4.3m, 10A/230V, C13 to DK2-5a (Denmark) Line Cord
Europe	39Y7917	6212	2.8m, 10A/230V, C13 to CEE7-VII (Europe) Line Cord
Europe	81Y2376	6572	4.3m, 10A/230V, C13 to CEE7-VII (Europe) Line Cord
India	39Y7927	6269	2.8m, 10A/250V, C13(2P+Gnd) (India) Line Cord
India	81Y2386	6567	4.3m, 10A/240V, C13 to IS 6538 (India) Line Cord
Israel	39Y7920	6218	2.8m, 10A/250V, C13 to SI 32 (Israel) Line Cord
Israel	81Y2381	6579	4.3m, 10A/230V, C13 to SI 32 (Israel) Line Cord
Italy/Chile	39Y7921	6217	2.8m, 220-240V, C13 to CEI 23-16 (Italy/Chile) Line Cord
Italy/Chile	81Y2380	6493	4.3m, 10A/230V, C13 to CEI 23-16 (Italy/Chile) Line Cord
Japan	46M2593	A1RE	2.8m, 12A/125V, C13 to JIS C-8303 (Japan) Line Cord
Japan	4L67A08357	6533	2.8m, 200V, C13 to JIS C-8303 (Japan) Line Cord
Japan	39Y7926	6335	4.3m, 12A/100V, C13 to JIS C-8303 (Japan) Line Cord
Japan	4L67A08362	6495	4.3m, 12A/200V, C13 to JIS C-8303 (Japan) Line Cord
South Africa	39Y7922	6214	2.8m, 10A/250V, C13 to SABS 164 (S Africa) Line Cord
South Africa	81Y2379	6576	4.3m, 10A/230V, C13 to SABS 164 (South Africa) Line Cord

Region	Part number	Feature	Description
South Korea	39Y7925	6219	2.8m, 220-240V, C13 to KETI (S Korea) Line Cord
South Korea	81Y2385	6494	4.3m, 12A/220V, C13 to KSC 8305 (S. Korea) Line Cord
Switzerland	39Y7919	6216	2.8m, 10A/250V, C13 to SEV 1011-S24507 (Swiss) Line Cord
Switzerland	81Y2390	6578	4.3m, 10A/230V, C13 to SEV 1011-S24507 (Sws) Line Cord
Taiwan	23R7158	6386	2.8m, 10A/125V, C13 to CNS 10917-3 (Taiwan) Line Cord
Taiwan	81Y2375	6317	2.8m, 10A/240V, C13 to CNS 10917-3 (Taiwan) Line Cord
Taiwan	4L67A08363	AX8B	4.3m, 10A/125V, C13 to CNS 10917 (Taiwan) Line Cord
Taiwan	81Y2389	6531	4.3m, 10A/250V, C13 to 76 CNS 10917-3 (Taiwan) Line Cord
UK	39Y7923	6215	2.8m, 10A/250V, C13 to BS 1363/A (UK) Line Cord
UK	81Y2377	6577	4.3m, 10A/230V, C13 to BS 1363/A (UK) Line Cord
US/Canada	90Y3016	6313	2.8m, 10A/120V, C13 to NEMA 5-15P (US) Line Cord
US/Canada	46M2592	A1RF	2.8m, 10A/250V, C13 to NEMA 6-15P Line Cord
US/Canada	4L67A08359	6370	4.3m, 10A/125V, C13 to NEMA 5-15P (US) Line Cord
US/Canada	4L67A08361	6373	4.3m, 10A/250V, C13 to NEMA 6-15P (US) Line Cord

Systems management

ST50 models with Intel Xeon E processors support Intel Active Management Technology (AMT) 12.0 which provides out-of-band, hardware-based advanced system control, monitoring, alerting, and remote presence functions.

ST50 models with Core i3, Pentium, or Celeron processors support Intel Standard Manageability (ISM), which is a subset of the AMT features.

Both AMT and ISM offer the following features:

- Out-of-band management
- System health and status monitoring
- System event log and alerting
- Hardware inventory
- Boot device selection
- Remote power control
- Serial over LAN
- IDE/USB Redirect for mounting remote media

In addition, AMT supports the following feature:

- KVM (keyboard, video, mouse) redirection

Note: KVM redirection requires an Intel Xeon E processor with integrated graphics.

Health monitoring, event log, alerts, hardware inventory, boot device selection, and remote power control features are accessible out-of-band with a web browser. Serial over LAN, IDE/USB Redirect, and KVM redirection features require third-party tools that are not supplied or supported by Lenovo.

Both AMT and ISM operate independently of the server and remain operational even if the server is powered off. Out-of-band management is performed through the standard Gigabit Ethernet port, which is a shared port for data and management.

AMT and ISM support the following management protocols:

- DASH 1.1
- WS-MAN
- SNMP Platform Event Traps (PET)

Note: The ST50 server does not have an XClarity Controller (XCC) management processor

Lenovo XClarity Provisioning Manager Lite

Lenovo XClarity Provisioning Manager Lite (LXPM Lite) is a USB memory key-based application for system setup and firmware upgrades.

The software tool provides the following functions:

- Easy-to-use, language-selectable graphical interface
- Integrated help system
- Automatic hardware detection
- Ability to install an operating system and device drivers either in an unattended mode or manually
- Ability to clone the settings in one server to other similarly configured Lenovo servers
- Supports RAID setup
- Diagnostics for memory test, hard disk drive test, and RAID log collection.

The LXPM Lite user interface is shown in the following figure.

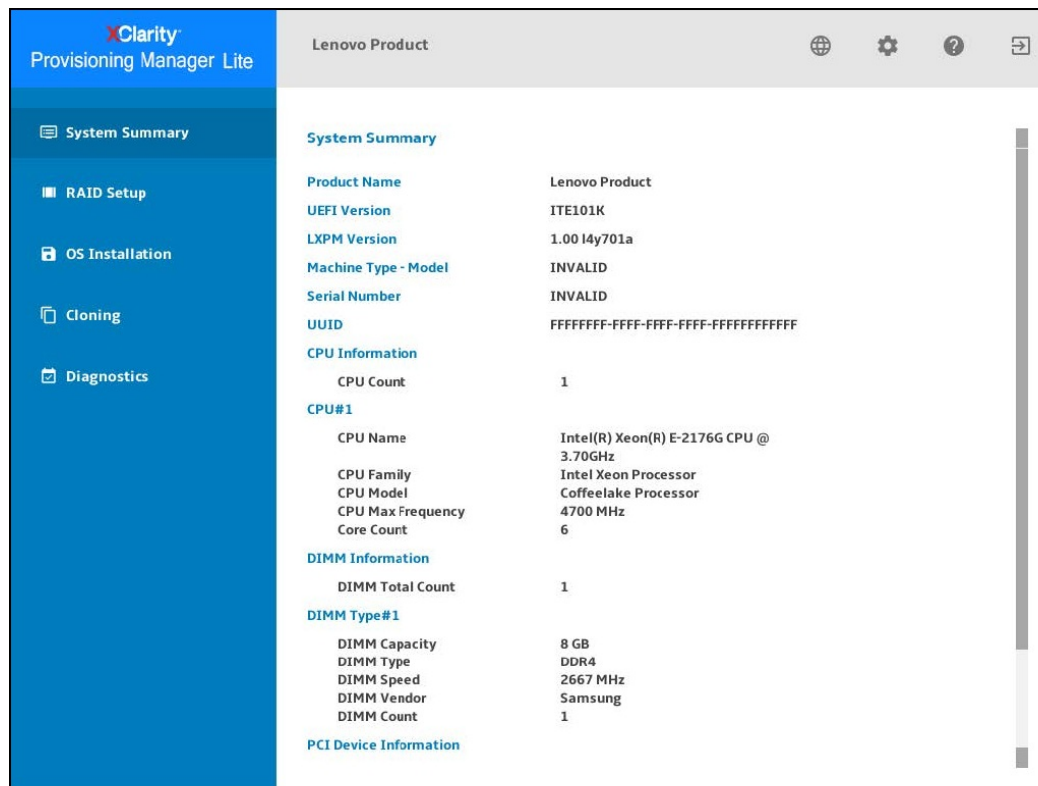

Figure 8. Lenovo XClarity Provisioning Manager Lite user interface

For more information about LXPM Lite, and to download the application, see the following support page:

<https://datacentersupport.lenovo.com/us/en/solutions/HT507133>

Security

The ST50 offers the following security features:

- Electronic security measures:
 - Administrator and power-on passwords
 - Trusted Platform Module (TPM) supporting both TPM 1.2 and TPM 2.0
- Mechanical security measures
 - Loop for a padlock to prevent the side panel from being opened
 - Slot at the rear of the server for a Kensington Cable Lock
 - Optional chassis intrusion switch

The following table lists the security options for the server. The location of the intrusion switch is shown in the [internal view of the server](#).

Table 25. Security features

Part number	Feature code	Description
4Z57A15948	B364	ThinkSystem Chassis Intrusion Switch Kit for Side Door

Keyboards and Mice

The following table lists the supported full-sized USB keyboards and mice available for Lenovo ThinkSystem servers.

The keyboards have the following features:

- Full-sized 104-key keyboard with 3 special Windows keys
- 3 LEDs for caps lock, scroll lock and num lock
- Wired USB connection with 1.8m cable
- Adjustable feet at the rear of the keyboard

Tip: For keyboards that fit in the rack-mounted console kit, see the [KVM console options](#) section, or the [1U 18.5-inch Standard Media Console](#) product guide.

Table 26. Lenovo Preferred Pro USB Full-sized keyboards - ThinkSystem

Part number	Feature code	Description
Mice		
7M57A04698	B0LN	ThinkSystem Optical Wheel Mouse - USB
Keyboards		
7ZB7A05521	AXTM	ThinkSystem Pref. Pro Keyboard USB - Arabic 253 RoHS v2
7ZB7A05520	AXTN	ThinkSystem Pref. Pro Keyboard USB - Arabic French 462 RoHS v2
7ZB7A05519	AXTP	ThinkSystem Pref. Pro Keyboard USB - Belgium/French 120 RoHS v2
7ZB7A05518	AXTQ	ThinkSystem Pref. Pro Keyboard USB - Belgium/UK 120 RoHS v2
7ZB7A05517	AXTR	ThinkSystem Pref. Pro Keyboard USB - Brazil/Portuguese 275 RoHS v2
7ZB7A05515	AXTS	ThinkSystem Pref. Pro Keyboard USB - Bulgarian 442 RoHS v2
7ZB7A05511	AXTU	ThinkSystem Pref. Pro Keyboard USB - Czech RoHS v2
7ZB7A05509	AXTV	ThinkSystem Pref. Pro Keyboard USB - Danish 159 RoHS v2
7ZB7A05508	AXTW	ThinkSystem Pref. Pro Keyboard USB - Dutch 143 RoHS v2
7ZB7A05506	AXTX	ThinkSystem Pref. Pro Keyboard USB - French 189 roHS v2

Part number	Feature code	Description
7ZB7A05496	AXTZ	ThinkSystem Pref. Pro Keyboard USB - French Canadian 058 French RoHS v2
7ZB7A05504	AXTY	ThinkSystem Pref. Pro Keyboard USB - French Canadian 445 Multilingual RoHS v2
7ZB7A05495	AXU0	ThinkSystem Pref. Pro Keyboard USB - German 129 RoHS v2
7ZB7A05494	AXU1	ThinkSystem Pref. Pro Keyboard USB - Greek 319 RoHS v2
7ZB7A05493	AXU2	ThinkSystem Pref. Pro Keyboard USB - Hebrew RoHS v2
7ZB7A05492	AXU3	ThinkSystem Pref. Pro Keyboard USB - Hungarian 208 RoHS v2
7ZB7A05491	AXU4	ThinkSystem Pref. Pro Keyboard USB - Iceland 197 RoHS v2
7ZB7A05490	AXU5	ThinkSystem Pref. Pro Keyboard USB - Italy 141 RoHS v2
7ZB7A05489	AXU6	ThinkSystem Pref. Pro Keyboard USB - Japanese 194 RoHS
7ZB7A05488	AXU7	ThinkSystem Pref. Pro Keyboard USB - Korean 413 RoHS v2
7ZB7A05487	AXU8	ThinkSystem Pref. Pro Keyboard USB - LA Spanish 171 RoHS v2
7ZB7A05486	AXU9	ThinkSystem Pref. Pro Keyboard USB - Norwegian 155 RoHS v2
7ZB7A05485	AXUA	ThinkSystem Pref. Pro Keyboard USB - Polish RoHS v2
7ZB7A05484	AXUB	ThinkSystem Pref. Pro Keyboard USB - Portuguese 163 RoHS v2
7ZB7A05483	AXUC	ThinkSystem Pref. Pro Keyboard USB - Romanian RoHS v2
7ZB7A05482	AXUD	ThinkSystem Pref. Pro Keyboard USB - Russian/Cyrillic 441 RoHS v2
7ZB7A05481	AXUE	ThinkSystem Pref. Pro Keyboard USB - Serbian/Cyrillic RoHS v2
7ZB7A05480	AXUF	ThinkSystem Pref. Pro Keyboard USB - Slovak 245 RoHS v2
7ZB7A05471	AXUQ	ThinkSystem Pref. Pro Keyboard USB - Slovenian 234 RoHS v2
7ZB7A05479	AXUG	ThinkSystem Pref. Pro Keyboard USB - Spanish 172 RoHS v2
7ZB7A05478	AXUH	ThinkSystem Pref. Pro Keyboard USB - Swedish/Finn 153 RoHS v2
7ZB7A05477	AXUJ	ThinkSystem Pref. Pro Keyboard USB - Swiss F/G 150 RoHS v2
7ZB7A05476	AXUK	ThinkSystem Pref. Pro Keyboard USB - Thailand 191 RoHS v2
7ZB7A05513	AXTT	ThinkSystem Pref. Pro Keyboard USB - Trad Chinese/US 467 RoHS v2
7ZB7A05474	AXUM	ThinkSystem Pref. Pro Keyboard USB - Turkish 179 RoHS v2
7ZB7A05475	AXUL	ThinkSystem Pref. Pro Keyboard USB - Turkish 440 RoHS v2
7ZB7A05473	AXUN	ThinkSystem Pref. Pro Keyboard USB - UK English 166 RoHS v2
7ZB7A05522	AXTL	ThinkSystem Pref. Pro Keyboard USB - US English 103P RoHS v2
7ZB7A05472	AXUP	ThinkSystem Pref. Pro Keyboard USB - US Euro 103P RoHS v2

Video port adapters

The ST50 has two integrated DisplayPort video ports at the back of the server. To use these ports with VGA or HDMI cables, use the dongle adapters listed in the following table.

Tip: Some models include a dongle kit. See the [Models](#) section for specifics.

Table 27. Video port dongles

Part number	Feature code	Description	Maximum supported
4X97A12100	B366	ThinkSystem ST50 DP to HDMI Dongle Kit	2
4X97A12099	B365	ThinkSystem ST50 DP to VGA Dongle Kit	2

Maximum display resolutions are as follows:

- Native DisplayPort: 3840 x 2160 pixels (4K) at a refresh rate of 60Hz
- With the DP to VGA Dongle Kit: 1920 x 1200 pixels at 60 Hz
- With the DP to HDMI Dongle Kit: 1920 x 1200 pixels at 60 Hz

Rack installation

The server can be installed in the rack with the Tower to Rack Conversion Kit, which converts the server to a 4U rack-mountable server.

Part number information is listed in the following table. The kit can only be ordered as an option part number, not in a CTO order.

Table 28. Rack installation options

Part number	Description
4M17A12785	ThinkSystem ST50/ST250 4U Rack Mount Kit

The rack mount kit includes the following items:

- Tray to hold the server horizontally
- Left and right slide rails
- Cable management arm
- Brackets and other hardware
- Installation instructions

Operating system support

The server supports the following operating systems:

- Microsoft Windows Server 2016
- Microsoft Windows Server 2019
- Red Hat Enterprise Linux 7.5
- Red Hat Enterprise Linux 7.7
- Red Hat Enterprise Linux 8.0
- Red Hat Enterprise Linux 8.1
- SUSE Linux Enterprise Server 12 SP5
- SUSE Linux Enterprise Server 12 Xen SP5
- SUSE Linux Enterprise Server 15 SP1
- SUSE Linux Enterprise Server 15 Xen SP1

- VMware ESXi 6.5 U2
- VMware ESXi 6.5 U3
- VMware ESXi 6.7 U2
- VMware ESXi 6.7 U3

For a complete list of supported, certified and tested operating systems, plus additional details and links to relevant web sites, see the Operating System Interoperability Guide:

<https://lenovopress.com/osig#servers=st50-7y48-7y49>

Virtualization support: The onboard SATA ports of the server can be used with virtualization hypervisors, including VMware ESXi, Linux KVM, Xen, and Microsoft Hyper-V Server, however support is limited to AHCI (non-RAID) mode. RSTe mode is not supported with virtualization hypervisors.

Note: The DisplayPort video ports require the following:

- Windows: Intel VGA driver is installed.
- Linux: kernel/boot parameter "i915.alpha_support=1" is added.

For configure-to-order (CTO) configurations, the server can be preloaded with VMware ESXi installed on an SD Card. Ordering information is listed in the following table.

Table 29. VMware ESXi preload

Part number	Feature code	Description
CTO only	B3VW	VMware ESXi 6.5 U2 (factory installed)
CTO only	B6U0	VMware ESXi 6.5 U3 (factory installed)
CTO only	B6U1	VMware ESXi 6.7 U2 (factory installed)
CTO only	B88T	VMware ESXi 6.7 U3 (factory installed)

Physical and electrical specifications

The server has the following dimensions and weight:

- Height: 375 mm (14.8 in)
- Width: 175 mm (6.9 in)
- Depth: 407 mm (16.0 in)
- Weight: Minimum: 7.5 kg (16.5 lb), maximum: 11.2 kg (24.7 lb)

Electrical requirements are as follows:

- Chassis with 250W power supply:
 - 100-127 (nominal) V ac; 50 Hz or 60 Hz; 4 A
 - 200 - 240 (nominal) V ac; 50 Hz or 60 Hz; 2 A
 - Allowable instantaneous voltage: 90 V ac minimum, 264 V ac maximum
 - Input kilovolt-amperes (kVA) (approximately):
 - Minimum configuration: 0.061 kVA
 - Maximum configuration: 0.208 kVA
- Chassis with 400W power supply:
 - 100-127 (nominal) V ac; 50 Hz or 60 Hz; 6 A
 - 200 - 240 (nominal) V ac; 50 Hz or 60 Hz; 3 A
 - Input kilovolt-amperes (kVA) (approximately):
 - Minimum configuration: 0.062 kVA
 - Maximum configuration: 0.212 kVA

Operating environment

The ThinkSystem ST50 server complies with ASHRAE Class A2 specifications:

- Temperature: 10°C to 35°C
- Humidity: 8% to 80%
- Altitude 0-3000 m (10,000 ft), derated 1°C per 300 m above 950 m

Non-operating environment support:

- Without packaging:
 - Temperature: -10 °C to 60 °C
 - Humidity: 8 to 90%
- Storage with packaging:
 - Temperature: -40 °C to 60 °C
 - Humidity: 8 to 90%

Thermal (heat) output:

- Minimum configuration: 221 BTU/h, 65 W
- Maximum configuration: 699 BTU/h, 205 W

Acoustical noise emissions: See the following table.

Table 30. Acoustical noise emissions

	Minimum	Typical	Maximum
Sound power level			
Idle	2.9 bels	3.4 bels	4.6 bels
Operating	2.9 bels	3.4 bels	4.6 bels
Sound pressure level (tabletop)			
Idle	17.3 dBA	25.3 dBA	36.7 dBA
Operating	17.1 dBA	25.6 dBA	37.2 dBA
Sound pressure level (floor)			
Idle	15.2 dBA	18.4 dBA	29.3 dBA
Operating	15.1 dBA	19.5 dBA	29.5 dBA

Notes:

- These sound levels were measured in controlled acoustical environments according to procedures specified by ISO 7779 and are reported in accordance with ISO 9296.
- The declared acoustic noise levels are based on specified configurations, which may change slightly depending on configuration/conditions.

Warranty and Support

The ST50 has a 1-year or 3-year warranty, based on the machine type of the system:

- 7Y49 - 1 year warranty
- 7Y48 - 3 year warranty

The standard warranty terms are customer-replaceable unit (CRU) and onsite (for field-replaceable units FRUs only) with standard call center support during normal business hours and 9x5 Next Business Day Parts Delivered.

Lenovo's additional support services provide a sophisticated, unified support structure for your data center, with an experience consistently ranked number one in customer satisfaction worldwide. Available offerings include:

- **Premier Support**

Premier Support provides a Lenovo-owned customer experience and delivers direct access to technicians skilled in hardware, software, and advanced troubleshooting, in addition to the following:

- Direct technician-to-technician access through a dedicated phone line
- 24x7x365 remote support
- Single point of contact service
- End to end case management
- Third-party collaborative software support
- Online case tools and live chat support
- On-demand remote system analysis

- **Warranty Upgrade (Preconfigured Support)**

Services are available to meet the on-site response time targets that match the criticality of your systems.

- 3, 4, or 5 years of service coverage
- **Foundation Service:** 9x5 service coverage with next business day onsite response. YourDrive YourData is an optional extra (see below).
- **Essential Service:** 24x7 service coverage with 4-hour onsite response or 24-hour committed repair (available only in select countries). Bundled with YourDrive YourData.
- **Advanced Service:** 24x7 service coverage with 2-hour onsite response or 6-hour committed repair (available only in select countries). Bundled with YourDrive YourData.

- **Managed Services**

Lenovo Managed Services provides continuous 24x7 remote monitoring (plus 24x7 call center availability) and proactive management of your data center using state of the art tools, systems, and practices by a team of highly skilled and experienced Lenovo services professionals.

Quarterly reviews check error logs, verify firmware & OS device driver levels, and software as needed. We'll also maintain records of latest patches, critical updates, and firmware levels, to ensure your systems are providing business value through optimized performance.

- **Technical Account Management (TAM)**

A Lenovo Technical Account Manager helps you optimize the operation of your data center based on a deep understanding of your business. You gain direct access to your Lenovo TAM, who serves as your single point of contact to expedite service requests, provide status updates, and furnish reports to track incidents over time. In addition, your TAM will help proactively make service recommendations and manage your service relationship with Lenovo to make certain your needs are met.

- **Enterprise Server Software Support**

Enterprise Software Support is an additional support service providing customers with software support on Microsoft, Red Hat, SUSE, and VMware applications and systems. Around the clock availability for critical problems plus unlimited calls and incidents helps customers address challenges fast, without incremental costs. Support staff can answer troubleshooting and diagnostic questions, address product comparability and interoperability issues, isolate causes of problems, report defects to software vendors, and more.

- **YourDrive YourData**

Lenovo's YourDrive YourData is a multi-drive retention offering that ensures your data is always under your control, regardless of the number of drives that are installed in your Lenovo server. In the unlikely event of a drive failure, you retain possession of your drive while Lenovo replaces the failed drive part. Your data stays safely on your premises, in your hands. The YourDrive YourData service can be purchased in convenient bundles, and is optional with Foundation Service. It is bundled with Essential Service and Advanced Service.

- **Health Check**

Having a trusted partner who can perform regular and detailed health checks is central to maintaining efficiency and ensuring that your systems and business are always running at their best. Health Check supports Lenovo-branded server, storage, and networking devices, as well as select Lenovo-supported products from other vendors that are sold by Lenovo or a Lenovo-Authorized Reseller.

Examples of region-specific warranty terms are second or longer business day parts delivery or parts-only base warranty.

If warranty terms and conditions include onsite labor for repair or replacement of parts, Lenovo will dispatch a service technician to the customer site to perform the replacement. Onsite labor under base warranty is limited to labor for replacement of parts that have been determined to be field-replaceable units (FRUs). Parts that are determined to be customer-replaceable units (CRUs) do not include onsite labor under base warranty.

If warranty terms include parts-only base warranty, Lenovo is responsible for delivering only replacement parts that are under base warranty (including FRUs) that will be sent to a requested location for self-service. Parts-only service does not include a service technician being dispatched onsite. Parts must be changed at customer's own cost and labor and defective parts must be returned following the instructions supplied with the spares parts.

Lenovo Service offerings are region-specific. Not all preconfigured support and upgrade options are available in every region. For information about Lenovo service upgrade offerings that are available in your region, refer to the following resources:

- Service part numbers in Lenovo Data Center Solution Configurator (DCSC):
<http://dcsc.lenovo.com/#/services>
- Lenovo Services Availability Locator
<http://lenovocator.com/>

For service definitions, region-specific details, and service limitations, please refer to the following documents:

- Lenovo Statement of Limited Warranty for Data Center Group (DCG) Servers and System Storage
<http://pcsupport.lenovo.com/us/en/solutions/ht503310>
- Lenovo Data Center Services Agreement
<http://support.lenovo.com/us/en/solutions/ht116628>

Services

Lenovo Services is a dedicated partner to your success. Our goal is to reduce your capital outlays, mitigate your IT risks, and accelerate your time to productivity.

Here's a more in-depth look at what we can do for you:

- **Asset Recovery Services**

Asset Recovery Services (ARS) helps customers recover the maximum value from their end-of-life equipment in a cost-effective and secure way. On top of simplifying the transition from old to new equipment, ARS mitigates environmental and data security risks associated with data center equipment disposal. Lenovo ARS is a cash-back solution for equipment based on its remaining market value, yielding maximum value from aging assets and lowering total cost of ownership for your customers. For more information, see the ARS page, <https://lenovopress.com/lp1266-reduce-e-waste-and-grow-your-bottom-line-with-lenovo-ars>.

- **Assessment Services**

An Assessment helps solve your IT challenges through an onsite, multi-day session with a Lenovo technology expert. We perform a tools based assessment which provides a comprehensive and thorough review of a company's environment and technology systems. In addition to the technology based functional requirements, the consultant also discusses and records the non-functional business requirements, challenges, and constraints. Assessments help organizations like yours, no matter how large or small, get a better return on your IT investment and overcome challenges in the ever-changing technology landscape.

- **Design Services**

Professional Services consultants perform infrastructure design and implementation planning to support your strategy. The high-level architectures provided by the assessment service are turned into low level designs and wiring diagrams, which are reviewed and approved prior to implementation. The implementation plan will demonstrate an outcome-based proposal to provide business capabilities through infrastructure with a risk-mitigated project plan.

- **Basic Hardware Installation**

Lenovo experts can seamlessly manage the physical installation of your server, storage, or networking hardware. Working at a time convenient for you (business hours or off shift), the technician will unpack and inspect the systems on your site, install options, mount in a rack cabinet, connect to power and network, check and update firmware to the latest levels, verify operation, and dispose of the packaging, allowing your team to focus on other priorities.

- **Deployment Services**

When investing in new IT infrastructures, you need to ensure your business will see quick time to value with little to no disruption. Lenovo deployments are designed by development and engineering teams who know our Products & Solutions better than anyone else, and our technicians own the process from delivery to completion. Lenovo will conduct remote preparation and planning, configure & integrate systems, validate systems, verify and update appliance firmware, train on administrative tasks, and provide post-deployment documentation. Customer's IT teams leverage our skills to enable IT staff to transform with higher level roles and tasks.

- **Integration, Migration, and Expansion Services**

Move existing physical & virtual workloads easily, or determine technical requirements to support increased workloads while maximizing performance. Includes tuning, validation, and documenting ongoing run processes. Leverage migration assessment planning documents to perform necessary migrations.

Some service options may not be available in all countries. For more information, go to <https://www.lenovo.com/systems/services>. For information about Lenovo service upgrade offerings that are available in your region, contact your local Lenovo sales representative or business partner.

Regulatory compliance

The ST50 server conforms to the following standards:

- USA FCC Title 47 CFR Part 15 Subpart B
- Canada ICES-003, issue 6, Class A
- UL62368-1
- CSA C22.2, No. 62368-1-14
- NOM-019
- Argentina IEC60950-1
- Australia/New Zealand AS/NZS CISPR 32, Class A
- Japan VCCI 32-1
- IEC 60950-1 (CB Certificate and CB Test Report), IEC 62368-1 (CB Certificate and CB Test Report)
- China CCC (GB4943.1), GB9254 Class A, GB17625.1, CECP, CELP
- Taiwan BSMI CNS13438, Class A; CNS14336-1
- Korea KN32, Class A; KN35
- Russia, Belorussia and Kazakhstan, TR CU 020/2011 and TR CU 004/2011
- CE Mark (EN55032 Class A, EN60950-1, EN55024, EN61000-3-2, and EN61000-3-3, EN 62368-1)
- CISPR 32, Class A
- TUV-GS (EN62368-1, EK1-ITB2000)
- India BIS certification

External drive enclosures

The server supports attachment to external drive enclosures using a RAID controller with external ports or a SAS host bus adapter. Adapters supported by the server are listed in the [SAS adapters for external storage](#) section.

Note: Information provided in this section is for ordering reference purposes only. For the operating system and adapter support details, refer to the interoperability matrix for a particular storage enclosure that can be found on the Lenovo Data Center Support web site:

<http://datacentersupport.lenovo.com>

Table 31. External drive enclosures

Description	Part number		
	Worldwide	Japan	PRC
Lenovo Storage D1212 LFF Disk Expansion with Dual SAS IO Modules	4587A11	4587A1J	4587A1C
Lenovo Storage D1224 SFF Disk Expansion with Dual SAS IO Modules	4587A31	4587A3J	4587A3C
Lenovo Storage D3284 4TB x 84 HD Expansion Enclosure	641311F		
Lenovo Storage D3284 6TB x 84 HD Expansion Enclosure	641312F		
Lenovo Storage D3284 8TB x 84 HD Expansion Enclosure	641313F		
Lenovo Storage D3284 10TB x 84 HD Expansion Enclosure	641314F		

For details about supported drives, adapters, and cables, see the following Lenovo Press Product Guides:

- Lenovo Storage D1212 and D1224
<http://lenovopress.com/lp0512>
- Lenovo Storage D3284
<http://lenovopress.com/lp0513>

Top-of-rack Ethernet switches

The following table lists the Ethernet LAN switches that are offered by Lenovo.

Table 32. Ethernet LAN switches

Part number	Description
1 Gb Ethernet Rack switches	
7Y810011WW	Lenovo ThinkSystem NE0152T RackSwitch (Rear to Front)
7Z320011WW	Lenovo ThinkSystem NE0152TO RackSwitch (Rear to Front, ONIE)
7159BAX	Lenovo RackSwitch G7028 (Rear to Front)
7159CAX	Lenovo RackSwitch G7052 (Rear to Front)
7159G52	Lenovo RackSwitch G8052 (Rear to Front)
7165H1X	Juniper EX2300-C PoE Switch
7165H2X	Juniper EX2300-24p PoE Switch
1 Gb Ethernet Campus switches	
7Z340011WW	Lenovo CE0128TB Switch (3-Year Warranty)
7Z360011WW	Lenovo CE0128TB Switch (Limited Lifetime Warranty)
7Z340012WW	Lenovo CE0128PB Switch (3-Year Warranty)
7Z360012WW	Lenovo CE0128PB Switch (Limited Lifetime Warranty)
7Z350021WW	Lenovo CE0152TB Switch (3-Year Warranty)
7Z370021WW	Lenovo CE0152TB Switch (Limited Lifetime Warranty)
7Z350022WW	Lenovo CE0152PB Switch (3-Year Warranty)
7Z370022WW	Lenovo CE0152PB Switch (Limited Lifetime Warranty)
10 Gb Ethernet switches	
7159A1X	Lenovo ThinkSystem NE1032 RackSwitch (Rear to Front)
7159B1X	Lenovo ThinkSystem NE1032T RackSwitch (Rear to Front)
7159C1X	Lenovo ThinkSystem NE1072T RackSwitch (Rear to Front)
7159CRW	Lenovo RackSwitch G8272 (Rear to Front)
7159GR6	Lenovo RackSwitch G8296 (Rear to Front)
25 Gb Ethernet switches	
7159E1X	Lenovo ThinkSystem NE2572 RackSwitch (Rear to Front)
7Z210021WW	Lenovo ThinkSystem NE2572O RackSwitch (Rear to Front, ONIE)
100 Gb Ethernet switches	
7159D1X	Lenovo ThinkSystem NE10032 RackSwitch (Rear to Front)
7Z210011WW	Lenovo ThinkSystem NE10032O RackSwitch (Rear to Front, ONIE)

For more information, see the list of Product Guides in the following switch categories:

- 1 Gb Ethernet switches: <http://lenovopress.com/networking/tor/1gb?rt=product-guide>
- 10 Gb Ethernet switches: <http://lenovopress.com/networking/tor/10gb?rt=product-guide>
- 25 Gb Ethernet switches: <http://lenovopress.com/networking/tor/25gb?rt=product-guide>
- 40 Gb Ethernet switches: <http://lenovopress.com/networking/tor/40gb?rt=product-guide>
- 100 Gb Ethernet switches: <https://lenovopress.com/networking/tor/100Gb?rt=product-guide>

Uninterruptible power supply units

The server supports attachments to the uninterruptible power supply (UPS) units that are listed in the following table.

Table 33. Uninterruptible power supply units

Part number	Description
Tower UPS units	
55951AX	T1kVA Tower UPS (100-125VAC)
55951KX	T1kVA Tower UPS (200-240VAC)
55952AX	T1.5kVA Tower UPS (100-125VAC)
55952KX	T1.5kVA Tower UPS (200-240VAC)
Rack-mounted or tower UPS units	
55941AX	RT1.5kVA 2U Rack or Tower UPS (100-125VAC)
55941KX	RT1.5kVA 2U Rack or Tower UPS (200-240VAC)
55942AX	RT2.2kVA 2U Rack or Tower UPS (100-125VAC)
55942KX	RT2.2kVA 2U Rack or Tower UPS (200-240VAC)
55943AX	RT3kVA 2U Rack or Tower UPS (100-125VAC)
55943KX	RT3kVA 2U Rack or Tower UPS (200-240VAC)
55945KX	RT5kVA 3U Rack or Tower UPS (200-240VAC)
55946KX	RT6kVA 3U Rack or Tower UPS (200-240VAC)
55948KX	RT8kVA 6U Rack or Tower UPS (200-240VAC)
55949KX	RT11kVA 6U Rack or Tower UPS (200-240VAC)
55948PX	RT8kVA 6U 3:1 Phase Rack or Tower UPS (380-415VAC)
55949PX	RT11kVA 6U 3:1 Phase Rack or Tower UPS (380-415VAC)
Rack-mounted UPS units	
55943KT†	ThinkSystem RT3kVA 2U Standard UPS (200-230VAC) (2x C13 10A, 2x GB 10A, 1x C19 16A outlets)
55943LT†	ThinkSystem RT3kVA 2U Long Backup UPS (200-230VAC) (2x C13 10A, 2x GB 10A, 1x C19 16A outlets)
55946KT†	ThinkSystem RT6kVA 5U UPS (200-230VAC) (2x C13 10A outlets, 1x Terminal Block output)
5594XKT†	ThinkSystem RT10kVA 5U UPS (200-230VAC) (2x C13 10A outlets, 1x Terminal Block output)

† Only available in China and countries in the Asia Pacific region.

For more information, see the list of Product Guides in the UPS category:

<https://lenovopress.com/servers/options/ups>

Power distribution units

The following table lists the power distribution units (PDUs) that are offered by Lenovo.

Table 34. Power distribution units

Part number	Description
0U Basic PDUs	
00YJ776	0U 36 C13/6 C19 24A/200-240V 1 Phase PDU with NEMA L6-30P line cord

Part number	Description
00YJ777	0U 36 C13/6 C19 32A/200-240V 1 Phase PDU with IEC60309 332P6 line cord
00YJ778	0U 21 C13/12 C19 32A/200-240V/346-415V 3 Phase PDU with IEC60309 532P6 line cord
00YJ779	0U 21 C13/12 C19 48A/200-240V 3 Phase PDU with IEC60309 460P9 line cord
Switched and Monitored PDUs	
00YJ780	0U 20 C13/4 C19 Switched and Monitored 32A/200-240V/1Ph PDU w/ IEC60309 332P6 line cord
00YJ781	0U 20 C13/4 C19 Switched and Monitored 24A/200-240V/1Ph PDU w/ NEMA L6-30P line cord
00YJ782	0U 18 C13/6 C19 Switched / Monitored 32A/200-240V/346-415V/3Ph PDU w/ IEC60309 532P6 cord
00YJ783	0U 12 C13/12 C19 Switched and Monitored 48A/200-240V/3Ph PDU w/ IEC60309 460P9 line cord
46M4002*	1U 9 C19/3 C13 Switched and Monitored DPI PDU (without line cord)
46M4003*	1U 9 C19/3 C13 Switched and Monitored 60A 3 Phase PDU with IEC 309 3P+Gnd line cord
46M4004*	1U 12 C13 Switched and Monitored DPI PDU (without line cord)
46M4005*	1U 12 C13 Switched and Monitored 60A 3 Phase PDU with IEC 309 3P+Gnd line cord
Ultra Density Enterprise PDUs (9x IEC 320 C13 + 3x IEC 320 C19 outlets)	
71762NX	Ultra Density Enterprise C19/C13 PDU Module (without line cord)
71763NU	Ultra Density Enterprise C19/C13 PDU 60A/208V/3ph with IEC 309 3P+Gnd line cord
C13 Enterprise PDUs (12x IEC 320 C13 outlets)	
39M2816	DPI C13 Enterprise PDU+ (without line cord)
39Y8941	DPI Single Phase C13 Enterprise PDU (without line cord)
C19 Enterprise PDUs (6x IEC 320 C19 outlets)	
39Y8948	DPI Single Phase C19 Enterprise PDU (without line cord)
39Y8923	DPI 60A 3 Phase C19 Enterprise PDU with IEC 309 3P+G (208 V) fixed line cord
Front-end PDUs (3x IEC 320 C19 outlets)	
39Y8938	DPI 30amp/125V Front-end PDU with NEMA L5-30P line cord
39Y8939	DPI 30amp/250V Front-end PDU with NEMA L6-30P line cord
39Y8934	DPI 32amp/250V Front-end PDU with IEC 309 2P+Gnd line cord
39Y8940	DPI 60amp/250V Front-end PDU with IEC 309 2P+Gnd line cord
39Y8935	DPI 63amp/250V Front-end PDU with IEC 309 2P+Gnd line cord
NEMA PDUs (6x NEMA 5-15R outlets)	
39Y8905	DPI 100-127V PDU with Fixed NEMA L5-15P line cord
Line cords for PDUs that ship without a line cord	
40K9611	DPI 32a Line Cord (IEC 309 3P+N+G)
40K9612	DPI 32a Line Cord (IEC 309 P+N+G)
40K9613	DPI 63a Cord (IEC 309 P+N+G)
40K9614	DPI 30a Line Cord (NEMA L6-30P)
40K9615	DPI 60a Cord (IEC 309 2P+G)
40K9617	DPI Australian/NZ 3112 Line Cord
40K9618	DPI Korean 8305 Line Cord

* Not available in USA and Canada

For more information, see the Lenovo Press documents in the PDU category:
<https://lenovopress.com/servers/options/pdu>

Rack cabinets

The ST50 tower server can be converted to a 4U rack server using the Rack Mount Kit, as described in the [Rack installation](#) section.

The following table lists the supported rack cabinets.

Table 35. Rack cabinets

Part number	Description
93072RX	25U Standard Rack
93072PX	25U Static S2 Standard Rack
93634PX	42U 1100mm Dynamic Rack
93634EX	42U 1100mm Dynamic Expansion Rack
93604PX	42U 1200mm Deep Dynamic Rack
93614PX	42U 1200mm Deep Static Rack
93084EX	42U Enterprise Expansion Rack
93084PX	42U Enterprise Rack
93074RX	42U Standard Rack
Withdrawn rack cabinets	
201886X*	11U Office Enablement Kit
93604EX*	42U 1200mm Deep Dynamic Expansion Rack
93614EX*	42U 1200mm Deep Static Expansion Rack
93074XX*	42U Standard Rack Extension
93624PX*	47U 1200mm Deep Static Rack
93624EX*	47U 1200mm Deep Static Expansion Rack
93634BX*	PureFlex System 42U Expansion Rack
93634DX*	PureFlex System 42U Expansion Rack
93634AX*	PureFlex System 42U Rack
93634CX*	PureFlex System 42U Rack

* Withdrawn from marketing

For specifications about these racks, see the Lenovo Rack Cabinet Reference, available from: <https://lenovopress.com/lp0658-lenovo-rack-cabinet-reference>

For more information, see the list of Product Guides in the Rack cabinets category: <https://lenovopress.com/servers/options/racks>

Lenovo Financial Services

Lenovo Financial Services reinforces Lenovo's commitment to deliver pioneering products and services that are recognized for their quality, excellence, and trustworthiness. Lenovo Financial Services offers financing solutions and services that complement your technology solution anywhere in the world.

We are dedicated to delivering a positive finance experience for customers like you who want to maximize your purchase power by obtaining the technology you need today, protect against technology obsolescence, and preserve your capital for other uses.

We work with businesses, non-profit organizations, governments and educational institutions to finance their entire technology solution. We focus on making it easy to do business with us. Our highly experienced team of finance professionals operates in a work culture that emphasizes the importance of providing outstanding customer service. Our systems, processes and flexible policies support our goal of providing customers with a positive experience.

We finance your entire solution. Unlike others, we allow you to bundle everything you need from hardware and software to service contracts, installation costs, training fees, and sales tax. If you decide weeks or months later to add to your solution, we can consolidate everything into a single invoice.

Our Premier Client services provide large accounts with special handling services to ensure these complex transactions are serviced properly. As a premier client, you have a dedicated finance specialist who manages your account through its life, from first invoice through asset return or purchase. This specialist develops an in-depth understanding of your invoice and payment requirements. For you, this dedication provides a high-quality, easy, and positive financing experience.

For your region specific offers please ask your Lenovo sales representative or your technology provider about the use of Lenovo Financial Services. For more information, see the following Lenovo website:

<https://www.lenovo.com/us/en/landingpage/lenovo-financial-services/>

Related publications and links

For more information, see these resources:

- ThinkSystem ST50 product page
<https://www.lenovo.com/us/en/data-center/servers/towers/ThinkSystem-ST50/p/77XX7TRST51>
- ThinkSystem ST50 drivers and support
<http://datacentersupport.lenovo.com/products/servers/thinksystem/st50/7y48/downloads>
- Lenovo ThinkSystem ST50 product publications:
<http://thinksystem.lenovofiles.com/help/index.jsp>
 - Quick Start
 - Tower-to-Rack Conversion Kit Installation Instructions
 - Setup Guide
 - Maintenance Manual
 - Lenovo XClarity Provisioning Manager Lite User Guide
- ServerProven hardware compatibility:
<http://www.lenovo.com/us/en/serverproven>

Related product families

Product families related to this document are the following:

- [1-Socket Tower Servers](#)
- [ThinkSystem ST50 Server](#)

Notices

Lenovo may not offer the products, services, or features discussed in this document in all countries. Consult your local Lenovo representative for information on the products and services currently available in your area. Any reference to a Lenovo product, program, or service is not intended to state or imply that only that Lenovo product, program, or service may be used. Any functionally equivalent product, program, or service that does not infringe any Lenovo intellectual property right may be used instead. However, it is the user's responsibility to evaluate and verify the operation of any other product, program, or service. Lenovo may have patents or pending patent applications covering subject matter described in this document. The furnishing of this document does not give you any license to these patents. You can send license inquiries, in writing, to:

Lenovo (United States), Inc.
1009 Think Place - Building One
Morrisville, NC 27560
U.S.A.
Attention: Lenovo Director of Licensing

LENOVO PROVIDES THIS PUBLICATION "AS IS" WITHOUT WARRANTY OF ANY KIND, EITHER EXPRESS OR IMPLIED, INCLUDING, BUT NOT LIMITED TO, THE IMPLIED WARRANTIES OF NON-INFRINGEMENT, MERCHANTABILITY OR FITNESS FOR A PARTICULAR PURPOSE. Some jurisdictions do not allow disclaimer of express or implied warranties in certain transactions, therefore, this statement may not apply to you.

This information could include technical inaccuracies or typographical errors. Changes are periodically made to the information herein; these changes will be incorporated in new editions of the publication. Lenovo may make improvements and/or changes in the product(s) and/or the program(s) described in this publication at any time without notice.

The products described in this document are not intended for use in implantation or other life support applications where malfunction may result in injury or death to persons. The information contained in this document does not affect or change Lenovo product specifications or warranties. Nothing in this document shall operate as an express or implied license or indemnity under the intellectual property rights of Lenovo or third parties. All information contained in this document was obtained in specific environments and is presented as an illustration. The result obtained in other operating environments may vary. Lenovo may use or distribute any of the information you supply in any way it believes appropriate without incurring any obligation to you.

Any references in this publication to non-Lenovo Web sites are provided for convenience only and do not in any manner serve as an endorsement of those Web sites. The materials at those Web sites are not part of the materials for this Lenovo product, and use of those Web sites is at your own risk. Any performance data contained herein was determined in a controlled environment. Therefore, the result obtained in other operating environments may vary significantly. Some measurements may have been made on development-level systems and there is no guarantee that these measurements will be the same on generally available systems. Furthermore, some measurements may have been estimated through extrapolation. Actual results may vary. Users of this document should verify the applicable data for their specific environment.

© Copyright Lenovo 2020. All rights reserved.

This document, LP0960, was created or updated on January 24, 2020.

Send us your comments in one of the following ways:

- Use the online Contact us review form found at:
<http://lenovopress.com/LP0960>
- Send your comments in an e-mail to:
comments@lenovopress.com

This document is available online at <http://lenovopress.com/LP0960>.

Trademarks

Lenovo and the Lenovo logo are trademarks or registered trademarks of Lenovo in the United States, other countries, or both. A current list of Lenovo trademarks is available on the Web at <https://www.lenovo.com/us/en/legal/copytrade/>.

The following terms are trademarks of Lenovo in the United States, other countries, or both:

Lenovo Services

Lenovo®

RackSwitch

ServerProven®

ThinkSystem

TopSeller

TruDDR4

XClarity®

The following terms are trademarks of other companies:

Celeron®, Intel Core™, Intel®, Pentium®, and Xeon® are trademarks or registered trademarks of Intel Corporation or its subsidiaries in the United States and other countries.

Linux® is a trademark of Linus Torvalds in the United States, other countries, or both.

Hyper-V®, Microsoft®, Windows Server®, and Windows® are trademarks of Microsoft Corporation in the United States, other countries, or both.

Other company, product, or service names may be trademarks or service marks of others.